

# 2-Piece Cool Wave Slide Instructions

WS 5037,  
WS 5038, WS 5039

Fits 48" (121,9 cm) Deck Height

**WARNING: ASSEMBLY BY ADULT**

**FOR PRIVATE USE ONLY  
DO NOT USE IN PUBLIC SETTINGS!**

**KIT INCLUDES:**

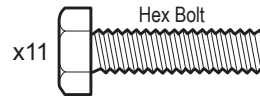
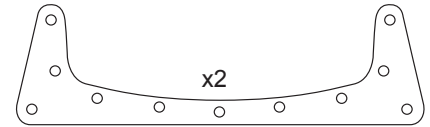
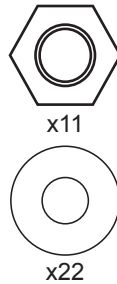
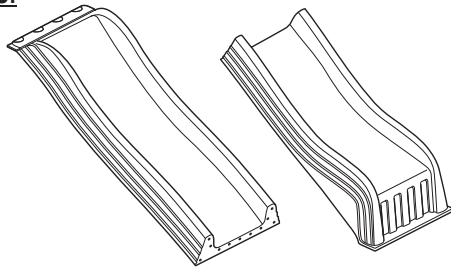

**Not Included In Kit:**

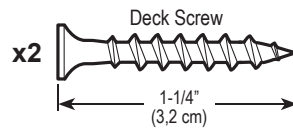
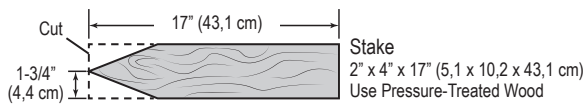

Screw size should be a #8 thread size minimum and coated for use with treated wood.

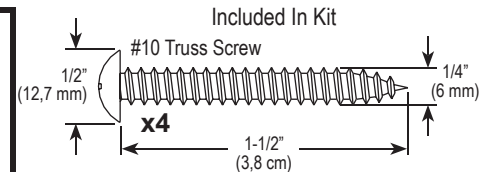

Screw must be to sizes shown at a minimum. Do not use a screw size shorter than 1-1/2" (3,8 cm) long.

**Tools Required:**

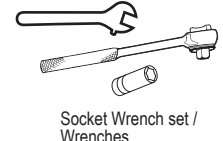
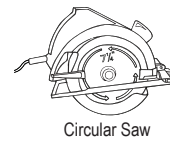
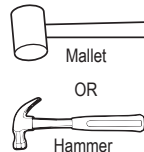
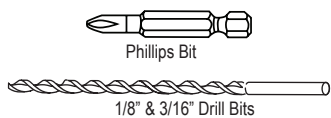

**ASSEMBLY STEPS**

1. Align slide sections and the backing plates together on the ground (Fig. 1). Begin attaching two slide sections together by securing the bolts in place finger tight (see Fig. 2 for proper Bolt Sequence). Following this pattern install (1) bolt, (2) washers and (1) lock-nut per hole (see Fig. 1). Once all (11) bolts, (22) flat washers and (11) lock-nuts are in place go back and tighten all hardware with appropriate tools.

**IMPORTANT: Tighten securely so backing plates and slide sections are tight against each other AND there are a minimum of one to two threads extending beyond each lock-nut.**

**Fig. 1**

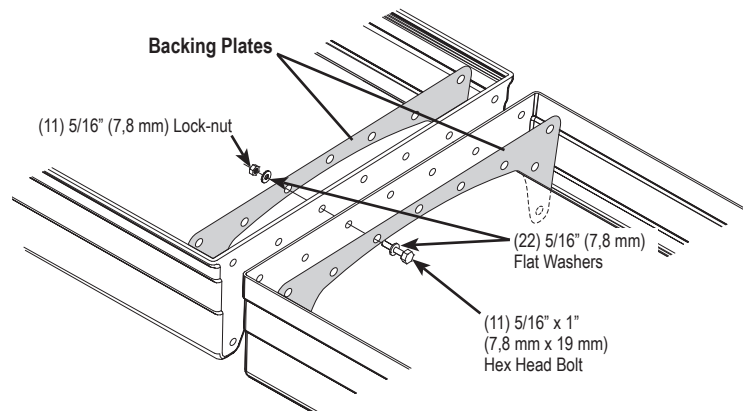

**Tighten nut until washers are tight against backing plates.**

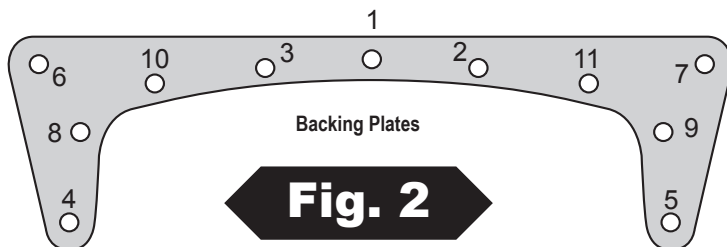
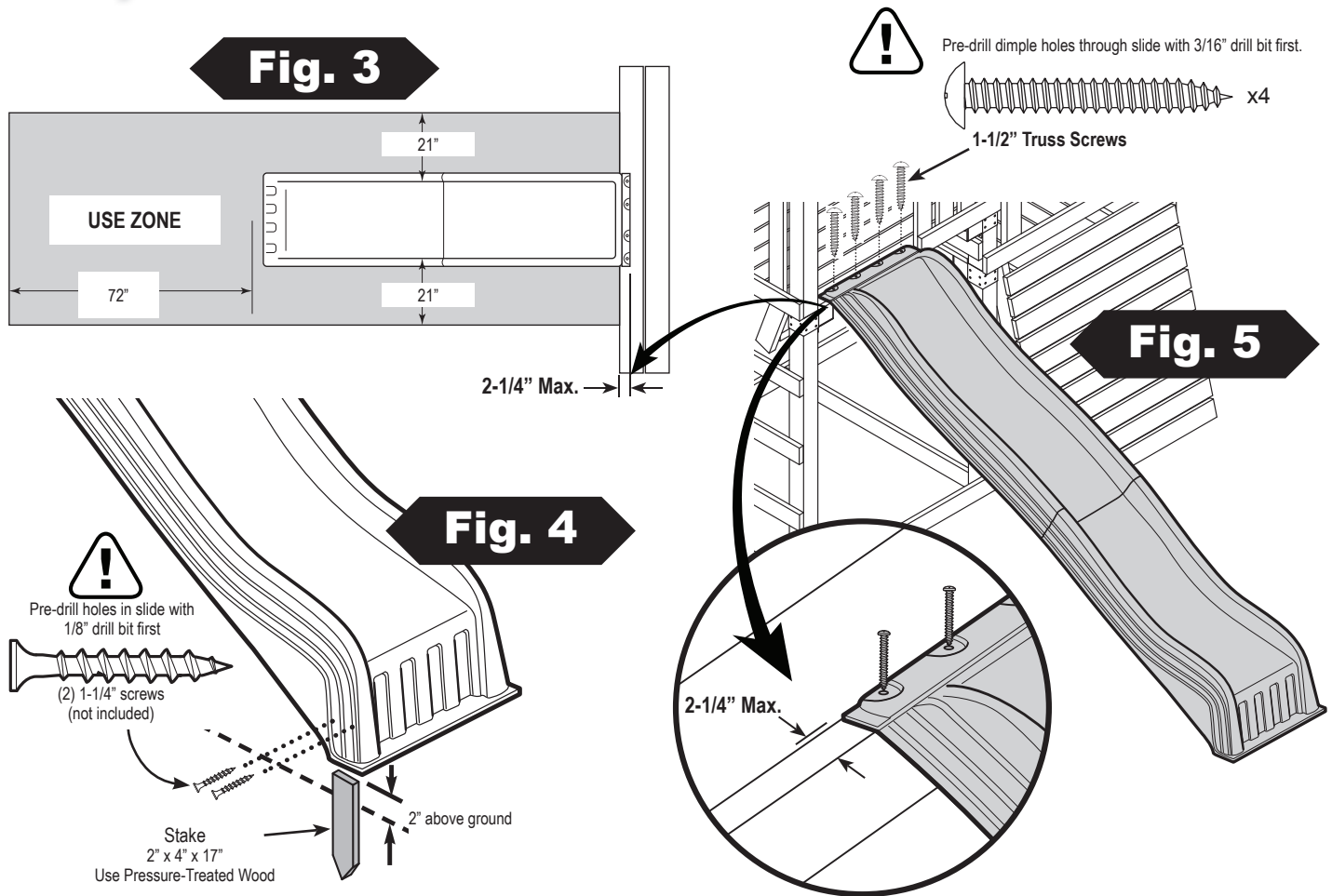

**Fig. 2**

**Weight Limit: 200 lbs  
For children 3-11 years of age**

Specifications subject to change without notice.  
Manufactured for: Backyard Play Systems • 166 Etowah Industrial Court • Canton, Georgia 30114 • USA • 1-800-882-0272 • playsupport@backyardproducts.com  
Made in USA • Printed in USA

# Assembly:



## ASSEMBLY STEPS

1. Consult (Fig. 3) for proper placement of slide on your unit. Make certain no objects lie within the grayed out area, or 'Use Zone.' Position slide to determine proper location for stake. **IMPORTANT:** Place the slide on level ground, not less than six feet from any structure or obstruction such as a fence, garage, house, overhanging branch, laundry line or electric wire. Protective surfacing must extend a minimum of 6ft. in all directions from the perimeter of the equipment or from the outermost edges of any component. A slide extending beyond the platform must have protective surfacing at least 6ft. out from both sides as well as the end. An area of 21" on either side of the slide should be free of obstructions which a child's arm could contact.
2. Drive wood stake (not included) into ground leaving 2" exposed (Fig. 4).
3. Using an 1/8" drill bit, drill (2) holes through the side of the slide. Secure the slide bottom to the stake using (2) 1-1/4" deck screws (Fig. 4).
4. Attach slide to unit as shown in (Fig. 5).

**Important:** Slide has four dimples. Use one screw at each dimple. Avoid locating dimples over any gaps in the playset deck.

Check for screws protruding underneath the deck.

If screws protrude, add a wooden slide block (not included) underneath the deck to cover screw ends. See Fig. 6 for an example slide block.

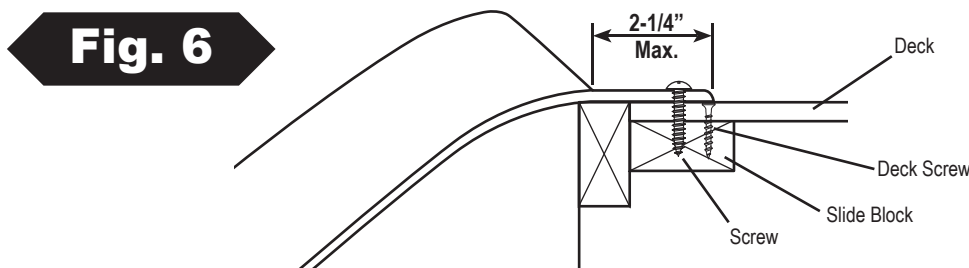

**Weight Limit:** 200 lbs

**For children 3-11 years of age**

Specifications subject to change without notice.

Manufactured for Backyard Play Systems • 166 Etowah Industrial Court • Canton, Georgia 30114 • USA • 1-800-882-0272 • playsupport@backyardproducts.com

Made in USA • Printed in USA

# Safety Checklist for Play Sets and Accessories

Observing the following statements and warnings reduces the likelihood of serious or fatal injury

## Installation Safety – Have You:

- Consulted the assembly instructions supplied with your particular model?
- Noted this accessory is to be used only on approved designs? (Do not alter its design or add/remove components.)
- Made sure all hardware is tightened securely? (Supplied bolt covers must also be fastened securely.)
- Using a hacksaw, cut off all protruding threaded ends of bolts and other fasteners and remove any sharp edges with a metal file as needed, and coated fastener ends with lead free paint?
- Placed the equipment on level ground, not less than six feet (1.8 meters) from any structure or obstruction such as a fence, garage, house, overhanging branches, laundry lines, or electrical wires?
- Made sure home playground equipment is not installed over concrete, asphalt, packed earth or any other hard surface? (A fall onto a hard surface can result in serious injury to the equipment user.)
- Verified that suspended climbing ropes, chain, or cable are securely anchored at both ends and cannot be looped back upon itself?
- Consulted in assembly instructions of your particular model for minimum use zones?
- Used a water sealant on your play set to protect the wood and prevent cracking and warping?
- Followed all anchoring and shock absorbing surfacing requirements below as they apply?
- Made sure not to allow children to use equipment until it is properly installed?
- Made sure to adjust all swings so there is a minimum 8" clearance between the swing and the ground surface?

**Play sets and accessories  
designed for children,  
ages 2 to 10 years, unless  
otherwise specified**

## Operating Safety – Have You:

- Determined that on-site adult supervision is provided for children of all ages?
- Warned children of the following before allowing them to use the equipment?
  - Not to walk close to, in front of, behind or between moving items.
  - Not to twist swing or any other accessory chains or ropes or loop them over the top support bar since this will reduce the strength of chain or rope.
  - Not to swing empty seats or other accessories.
  - Not to slide down swing chains.
  - Be sure to sit in the center of the swing seat and other accessories with full weight on the seat.
  - Not to attach items to the playground equipment that are not specifically designed for use with the equipment such as but not limited to, jump ropes, clotheslines, pet leashes, cables and chain. They may cause a strangulation hazard.
  - Not to climb or walk on the top of swing beams, railings or roof.
  - Not to use equipment in a manner other than intended.
  - Not to get off equipment while it is in motion.
  - Not to climb on the equipment when it is wet.
  - Be sure to go down slides feet first.
- Determined that only one child per planned occupant seat should be allowed on this set at one time.
- Determined children must be dressed appropriately for play. Avoid hooded jackets, bicycle or other sports helmets, clothing with draw strings and loose fitting clothes which could become entangled or snagged on equipment.
- Determined that suspended climbing ropes, chain, or cable are securely anchored at both ends and cannot be looped back upon itself.
- Made certain the slide is placed so that is not in direct sunlight.

## Safety Maintenance – Follow these preventive maintenance instructions at the intervals required:

- To prevent the deterioration of materials, remove plastic swing seats and other plastic accessories when outdoor temperature dips down to or below 32° F and take indoors. Reinstall these plastic elements at the beginning of each play season.
- At the beginning of each play season check metal parts for rust. If found, sand and repaint using a non lead-based paint meeting the requirements of 16 CFR 1303 or SOR/2005-109.
- At the beginning of each play season and once a month during each play season, check all moving parts for wear, rust or other deterioration. Replace as needed. If any of these conditions exist, call 1-800-882-0272 to order replacement accessories.
- At the beginning of each play season and once a month during each play season lubricate metallic moving parts.
- At the beginning of each play season and twice a month during each play season, check all protective coverings on bolts, pipes, edges, and corners. Replace if they are loose, cracked, or missing.
- At the beginning of each play season and twice a month during each play season, rake and check depth of loose fill protective surfacing material to prevent compaction and maintain appropriate depth. Replace as necessary.
- At the beginning of each play season and twice a month during each play season tighten all hardware.
- At the beginning of each play season and twice a month during each play season, check all wood members for deterioration and splinters.
- Sand down splinters and replace deteriorating wood members.

## Disposal Instructions

- When the equipment is taken out of service, it must be disassembled and disposed of in such a way that no unreasonable hazards will exist at the time the set is discarded.

**This product is intended for single family home/residential use only and not intended for use in any public setting. Placement in public settings constitutes misuse of this product.**  
**IMPORTANT! ADDITIONAL REQUIRED SAFETY INSTALLATION INSTRUCTIONS**

According to ASTM requirements, all kits must be anchored to the ground and, if the unit has a climbing rope, the rope end must be anchored. If soil conditions permit stakes to be pulled out easily, cementing into ground is necessary.

- To anchor the unit to the ground.** Follow the instructions included in this plan for applying Anchor-It devices to your unit, or use 2" x 4" x 18" (45mm x 95mm x 457mm) pressure-treated stakes. Pound stakes into ground at least 12" (305mm) at all inside corners of the posts (including A-frame legs and climbing unit posts). Attach with four (4) 3-1/2" screws (approved for treated wood) per stake into each tower and/or A-frame upright.
- If the unit has a climbing rope,** securely anchor the rope at both ends.
- Once the unit is completely assembled and before children are allowed to play on it,** proper shock-absorbing surfacing material must be installed. This may be accomplished by using loose-fill materials at a sufficient depth. The Consumer Product Safety Commission "Handbook for Public Playground Safety" lists the following materials and required depths that are sufficient for home/residential application. Supplemental information may be found in ASTM F1292. For fall height protection up to 9 ft. (2.742m) (recommended for all kits):

<u>LOOSE FILL MATERIAL REQUIRED</u>	<u>(UNCOMPRESSED) DEPTH<sup>1</sup> in. (mm)</u>
Wood Mulch	9" (229mm)
Double Shredded Bark Mulch	9" (229mm)
Uniform Wood Chips	12" (305mm)

When properly installed, shock absorbing material will completely cover the horizontal baseboards on climbing units. This protective surfacing must extend a minimum of 6 ft. (1.828m) in all directions from the perimeter of the equipment or from the outermost edges of any component. For example, a slide extending beyond the platform must have protective surfacing at least 6 ft. (1.828m) out from both sides as well as the end. For swings, the protective surface must extend at least 14 ft. (6m) out from both the back and front of the swing when the swing is in its rest position.

<sup>1</sup>These depths were derived from the CPSC Handbook. has not done independent tests to determine these required depths.

Save this instruction sheet in the event the manufacturer needs to be contacted.



# Warranty

---

## Swing-N-Slide® MANUFACTURERS LIMITED WARRANTY

Swing-N-Slide® takes great pride in the quality and durability of our products. Our Manufacturer's Limited Warranty provides confidence and demonstrates our commitment to providing quality residential playground products.

### MANUFACTURER'S LIFETIME LIMITED WARRANTY

Swing-N-Slide® warrants its thermoformed slides and climbing mountains to be free from defects in workmanship and materials, under normal use and conditions, for the lifetime of the product.

### MANUFACTURER'S 5 YEAR LIMITED WARRANTY

Swing-N-Slide® warrants its Custom Ready-to-Build Play Set kits to be free from defects in workmanship and materials, under normal use and conditions, for a period of 5 years.

### MANUFACTURER'S 5 YEAR LIMITED WARRANTY

Swing-N-Slide® warrants its No-Cut and Wood Complete Ready-to-Assemble Play Set kits against wood rot and termite damage, and to be free from defects in workmanship and materials, under normal use and conditions, for a period of 5 years for structural wood components.

**Cosmetic defects** that do not affect the structural integrity of the product, or natural defects of wood such as warping, splitting, checking, twisting, shrinkage, swelling or any other physical properties of wood that do not present a safety hazard, are not covered by this warranty.

### MANUFACTURER'S ACCESSORY, PLAYHOUSE WARRANTY

Swing-N-Slide® warrants its playset accessories and accessories sold separately as follows: Rope, Canopy/Tarps/Fabrics, Playhouses – 1 year. Plastic Components, Chains, Hardware and Fasteners – 5 years. These items to be free from defects in workmanship and materials, under normal use and conditions, for the period specified.

Swing-N-Slide® will repair, or at its discretion, replace any part within the stated warranty period which is defective in workmanship or materials. This decision is subject to verification of the defect upon delivery of the defective part to **Swing-N-Slide®** at 166 Etowah Industrial Ct. Canton, Georgia 30114. Any part(s) returned to **Swing-N-Slide®** must have prior approved Return Authorization Number and proof of purchase, including the date of purchase. This warranty is valid only if the product is used for the purpose for which it was designed and installed at a residential, single family dwelling. This warranty is void if the product is put to commercial or institutional use. This warranty does not cover (a) products which have been damaged by acts of Nature, negligence, misuse, or accident, or which have been modified or repaired by unauthorized persons; (b) the cost of labor; or the cost of shipping the product, any part, or any replacement product or part.

Swing-N-Slide® DISCLAIMS ALL OTHER REPRESENTATIONS AND WARRANTIES OF ANY KIND, EXPRESS, IMPLIED, STATUTORY OR OTHERWISE, INCLUDING THE IMPLIED WARRANTIES OF MERCHANTABILITY AND FITNESS FOR A PARTICULAR PURPOSE. Swing-N-Slide® WILL NOT BE LIABLE FOR ANY INCIDENTAL OR CONSEQUENTIAL DAMAGES. This warranty is non-transferable and does not extend to the owners of the product subsequent to the original purchaser. Some states do not allow limitations on implied warranties or exclusion of incidental or consequential damages, so these restrictions may not be applicable to you. This warranty gives you specific legal rights. You may also have other rights, which vary from state to state.

### This warranty also does not apply to:

- Structures not erected, maintained or inspected in conformance with **Swing-N-Slide®** installation plans
- Structures that have had parts added or substituted not in conformance with **Swing-N-Slide®** installation plans
- Parts that have been modified, altered or misused
- Parts that have not been used as designed or intended
- Damage due to acts of Nature, vandalism, abnormal use or abuse as determined by **Swing-N-Slide®**