

gorilla[®]
playsets



Blue Ridge Frontier

ASSEMBLY MANUAL
Copyright © 2011 Gorilla Playsets
All Rights Reserved

Gorilla Playsets • 190 Etowah Industrial Court Canton, GA 30114
(800) 882-0272 • www.gorillaplaysets.com
Latest Revision: April 18, 2011

TABLE OF CONTENTS

Warranty and Safety Guidelines.....	Pages 4-14
Kit Contents and Tool List.....	Pages 15-16
Hardware and Lumber Checklist.....	Pages 16-29
Adding T-Nuts to Corner Posts.....	Step 1
Framing Fort.....	Steps 2-7
Mounting Deck (Spacers, Supports and Boards).....	Steps 8-10
Building and Mounting Rockwall.....	Steps 11-15
Building and Mounting Climbing Ramp.....	Steps 16-19
Installing Panel Slats.....	Step 20
Swing Beam Assembly.....	Steps 21-28
Assembling Roof.....	Steps 29-33
Assembling Sunburst.....	Steps 34-36
Hanging Swings and installing Safety Board.....	Step 37-38
Assembling Picnic Table.....	Steps 39-41
Tire Swing Assembly.....	Step 42-49
Rope Ladder Installation.....	Steps 50-51
Mounting Slide, Telescope and Tic-Tac-Toe Panel.....	Steps 52-54
Installing Chimney and Dormers.....	Step 55
Installing Angle Supports.....	Steps 56-57
Installing Safety Handles, Climbing Ropes and Flag Kits.....	Steps 58-60
Customer Registration Card.....	Page 90

**PLEASE READ OWNER'S MANUAL CAREFULLY
BEFORE STARTING ASSEMBLY!**

IMPORTANT – PLEASE READ

As fresh lumber acclimates to its new environment, the natural tendencies of the tree can show itself in the form of checks, or “cracks” in the lumber. In almost all cases this is normal and it will not affect the structural integrity of your play set.

Cosmetic defects that do not affect the structural integrity of the product, or natural defects of wood such as warping, checking or any other physical properties of wood that do not present a safety hazard, are not covered by this warranty. Defects that develop because the product is exposed to extreme climate conditions are not covered by this warranty. Defects that develop as a result of faulty or improper installation of the product are also not covered by this warranty.

Most cracks are not warrantable, however if you believe that the integrity of your play set is compromised by this natural occurrence, please follow the warranty claim procedure found at www.gorillaplaysets.com. Click on the “Customer Care” tab on the left hand side of the page, then click on “Warranty Claim” and follow the instructions.

We appreciate your purchase and know that you will enjoy your play system for many years to come.

IF YOU HAVE MISSING OR DAMAGED PARTS OR NEED ASSISTANCE ASSEMBLING, PLEASE CALL Gorilla Playsets™ MANUFACTURING DIRECT. (800) 882-0272 FACTORY HOURS – MON.–FRI., 8AM-5PM EST DO NOT RETURN THIS PRODUCT TO THE RETAILER OR CONTACT THE RETAILER DIRECT. THE RETAILER DOES NOT STOCK COMPONENTS. PLEASE RETAIN THESE INSTRUCTIONS FOR FUTURE REFERENCE. KEEP THEM IN A SAFE PLACE WHERE YOU CAN REFER TO THEM AS NEEDED.

CONTACT INFO:

Gorilla Playsets
190 Etowah Industrial Court
Canton, GA 30114
Tel. (800) 882-0272
Fax. (678) 880-3329
custsrv@gorillaplaysets.com

Check for revised instructions at www.gorillaplaysets.com/category-s/92.htm

Thank you for choosing Gorilla Playsets®

We've included everything you need, except tools, to build your very own professional looking play set. When complete, your new play set should far exceed the quality of play set kits from other build-your-own companies. Our engineers and design team have over 30 years of playground experience. What we've developed is a play set that doesn't compromise quality for simplicity. Yet you'll appreciate how quick and easy construction really is! Our play set kits are designed for children ages 3 to 11. Gorilla Playsets® believes every child should have a play set and with our kits they can! You can rest assured your new play set is safe, durable and designed to hold up to the elements. As parents ourselves, we know how important the security and well-being of our children is, and this shows in all of our products.

Each play set features our step-by-step 3D illustrated manual, patented powder coated swing beam bracket, heavy-duty swing belts with chains, slide(s), accessories, plus all the required hardware and pre-milled lumber.

Limited Manufacturers Warranty

Gorilla Playsets® (“Gorilla”) warrants its play sets to be free from defects in workmanship and materials, under normal use and conditions at its original installation, for 10 years for structural wood components and for one year for all other components (e.g., hardware, plastics, tarps, rope ladder, etc.)

Cosmetic defects or natural defects of wood (e.g., warping, seasonal checking or cracking, knots, or knot holes, etc.) that do not affect the structural integrity of the product are not covered by this warranty. Defects that develop because the product is exposed to extreme climate conditions, or that develop as a result of faulty or improper installation of the product, are not covered by this warranty. Fading or discoloration of any part or accessory, cracks in plastic components, surface rust on hardware, and chips on powder coated materials are not considered defects in material as long as they do not affect the functionality or structural integrity of the part or component.

It is the owner’s responsibility to properly maintain the play set. Instructions for proper maintenance can be found on Gorilla’s website. Imperfections or defects that develop because of a failure to properly maintain the play set are not covered by this warranty.

Gorilla will repair or, at its discretion, replace any part within the stated warranty period that is defective in workmanship or materials. This decision is subject to verification of the defect, which, at Gorilla’s discretion, may be accomplished by submitting photographs or by delivery of the defective part to Gorilla. Any warranty claim must include proof of purchase, including the date of purchase.

This warranty is valid only if the product is used for the purpose for which it was designed and installed at a residential, single-family dwelling. This warranty is void if the product is used for commercial, institutional or multi-family dwelling use. This warranty does not cover (a) products that have been damaged by acts of God, negligence, misuse, or accident, or that have been modified or repaired by unauthorized persons; (b) the cost of labor; or (c) the cost of shipping the product, any part, or any replacement product or part.

GORILLA DISCLAIMS ALL OTHER REPRESENTATIONS AND WARRANTIES OF ANY KIND, EXPRESS, IMPLIED, STATUTORY, OR OTHERWISE, INCLUDING THE IMPLIED WARRANTIES OF MERCHANTABILITY AND FITNESS FOR A PARTICULAR PURPOSE. GORILLA WILL NOT BE LIABLE FOR ANY INCIDENTAL OR CONSEQUENTIAL DAMAGES. This warranty is valid only in the United States of America, is nontransferable and does not extend to the owners of the product subsequent to the original purchaser, and only applies to the product as originally installed (in other words, installing the product and then later disassembling and reinstalling the product at the same or another location voids the warranty). Some states do not allow limitations on implied warranties or exclusion of incidental or consequential damages, so these restrictions may not be applicable to you. This warranty gives you specific legal rights. You may also have other rights which vary from state to state.

Important Safety Guidelines

This product is intended for residential use only and not intended for use in any public setting. A safety surface such as mulch or recycled tire should be used under the play set to prevent injury from falls. Also a 6 foot safety zone should be used around the entire play set.

As with any home project, good judgment and respect for power tools will greatly reduce the risk of injury. Gorilla recommends you follow all tool manufacturers' safety guidelines. Always wear eye protection and safety gloves to prevent injury. In several phases of construction two people may be required for lifting and securing of lumber. While play set is being constructed, please keep children off the equipment until the project is complete. Bolts and screw heads should be checked regularly for tightness. The ground ladder, rope ladder, slide, swings and other areas where children spend a majority of their playtime should be checked more frequently.

Gorilla shall not be liable for incidental, indirect or consequential damages or injuries that result from the building and/or playing on our play sets. Adult supervision is recommended anytime a play set is being used.

WEIGHT LIMITS FOR GORILLA PLAYSETS

- FORT PLATFORMS: 800 LBS. TOTAL WEIGHT
- SWING BELTS: 175 LBS.
- GLIDER SWINGS: 70 LBS. PER CHILD
- TRAPEZE: 125 LBS.
- FULL BUCKET SWING: 50 LBS.
- TODDLER BUCKET SWING: 50 LBS.
- INFANT SWING: 35 LBS.
- TIRE SWING: 125 LBS. TOTAL WEIGHT
- ROPE LADDER: 75 LBS.
- ROCK WALL: 150 LBS.
- ALL SLIDES: 125 LBS.

Gorilla recommends that the weight limits for all components must not be exceeded. Failure to adhere to these and other safety guidelines could result in damage to the play set and injury to the users.

Safety and Maintenance Tips for Your New Play Set:

NOTE: Your children's safety is our #1 concern. Observing the following statements and warnings reduces the likelihood of serious or fatal injury. Please review these safety rules regularly with your children.

- This play set is designed for the use of 4 occupants who have a combined weight not exceeding 800 pounds on the elevated floor, 3 occupants who have a combined weight of 525 pounds on the swing area, for a total unit capacity of 7 occupants who have a combined weight of 1325. (this weight is not including the picnic table area)
- On-site adult supervision is required.
- Teach children not to walk close to, in front of, behind, or between moving swings or other moving playground equipment.
- Teach children to sit in and never stand on swings.
- Teach children not to twist the chains and ropes and not to loop them over the swing beam, since this may reduce the strength of the chain or rope.
- Teach children not to jump from swings or other playground equipment in motion.
- Teach children not to push empty seats. The seat may hit them and cause serious injury.
- Teach children to sit in the center of the swings with their full weight on the seats.
- Teach children not to use the equipment in a manner other than intended.
- Teach children to always go down slides feet first. Never slide headfirst.
- Teach children to look before they slide to make sure no one is at the bottom.
- Teach children to never run up a slide, as this increases their chances of falling.
- The parents should have the children dress appropriately with well-fitting shoes. Loose clothing such as scarves and ponchos should not be worn. Always take off, tie up or tuck in cords and drawstrings on children's clothing. These things can get caught on playground equipment and strangle a child.
- Teach children not to climb when the equipment is wet.
- Teach children to never jump from a fort deck. They should always use the ladder, ramp or slide.
- Teach children to never crawl or walk across the top of monkey bars.
- Teach children to never crawl on top of a fort roof.
- Verify that any suspended climbing ropes, chains, or cables are secured at both ends.
- Verify climbing ropes are tight enough that they cannot be wrapped around an adult hand.
- Teach children not to attach items to the playground equipment that are not specifically designed for use with the equipment, such as, but not limited to, jump ropes, clothesline, pet leashes, cables and chain as they may cause a strangulation hazard.
- Teach children to never wrap their legs around swing chain.
- Teach children to never slide down the swing chain.

WARNING: Children must NOT use this play set until unit has been completely assembled and inspected by an adult to insure set has been properly installed.

Safety and Maintenance Tips for Your New Play Set: (continued)

Playgrounds should be inspected on a regular basis. If any of the following conditions are noted, they should be removed, corrected, or repaired immediately to prevent injuries.

- Hardware that is loose, worn or that has protrusions or projections.
- Exposed equipment footings.
- Scattered debris, litter, rocks, or tree roots.
- Splinters, large cracks, and decayed wood components.
- Deterioration and corrosion on structural components, which connect to the ground.
- Missing or damaged equipment components, such as handholds, guardrails, swing seats.
- Check all nuts and bolts frequently during the usage season and tighten as required. (But not so tight that you crack the wood) We recommend you check the swing beam and hardware often due to wood expansion and contraction. It is particularly important that this procedure be followed at the beginning of each season.
- Remove plastic swing seats and take indoors or do not use when the temperature drops below 32°F.
- Oil all metallic moving parts monthly during the usage period.
- Check all coverings for bolts and sharp edges twice monthly during usage season to be certain they are in place. Replace when necessary. It is especially important to do this at the beginning of each new season.
- Check swing seats, ropes, cables and chains monthly during usage season for evidence of deterioration. Replacement should be made of any swing seat that has developed cracks in the plastic seats or has exposed metal in the edges of the swing seat. If there are already exposed metal inserts on the edge of the seat, immediately remove the seats and chains to prevent serious injury. Ropes, cables and chains should be removed and replaced if excessive wear is found. Contact Gorilla for warranted replacement parts.
- For rusted areas on metallic members such as monkey bars, hand supports brackets, etc.; sand and repaint, using a non lead-based paint meeting the requirements of Title 16 CRF Part 1303.
- Inspect wood parts monthly. The grain of the wood sometimes will lift in the dry season causing splinters to appear. Light sanding may be necessary to maintain a safe playing environment. If you are treating your play set with stain regularly, it will help prevent severe checking/splitting and other weather damage.
- Once or twice a year, depending on your climate conditions, you must apply some type of protection (sealant) to the wood of your unit. Prior to the application of sealant, lightly sand any “rough” spots on your set. Please note this is a requirement of your warranty.
- Creating and maintaining the play set on a level location is very important. As your children play, your play set will slowly dig its way into the soil, and it is very important that it settles evenly. Make sure the play set is level and true once each year or at the beginning of each play season.
- Rake the playground surface periodically to prevent compaction and maintain appropriate depths. Disposal Instructions: When the play set is no longer desired, it should be disassembled and disposed of in such away that no unreasonable hazards will exist at the time the unit is discarded.

Play Set Surfacing Recommendations:

Below are some of the recommendations that the U.S. Consumer Product Safety Commission (CPSC) offers from its *Handbook for Public Playground Safety*. The guide can be downloaded in full at www.cpsc.gov/cpsc/pub/pubs/325.pdf

1. Protective Surfacing - Since almost 60% of all injuries are caused by falls to the ground, protective surfacing under and around all playground equipment is the most critical safety factor on playgrounds.

Certain manufactured synthetic surfaces also are acceptable; however, test data on shock absorbing performance should be requested from the manufacturer.

Asphalt and concrete are unacceptable. They do not have any shock absorbing properties. Similarly, grass and turf should not be used. Their ability to absorb shock during a fall can be reduced considerably through wear and environmental conditions.

Certain loose-fill surfacing materials are acceptable such as the types and depths shown in the table.

Fall Heights and Recommended Materials

Type Of Material	6 in. depth	9 in. depth	12 in. depth
Double-Shredded bark mulch	6' Fall Height	10' Fall Height	11' Fall Height
Wood Chips	6' Fall Height	7' Fall Height	12' Fall Height
Fine Sand	5' Fall Height	5' Fall Height	9' Fall Height
Shredded Tires*	10-12' Fall Height	n/a	n/a
Fine Gravel	6' Fall Height	7' Fall Height	10' Fall Height

*This data is from tests conducted by independent testing laboratories on a 6-inch depth of uncompressed shredded tire samples produced by four manufacturers. The tests reported critical heights, which varied from 10 feet to greater than 12 feet. It is recommended that persons seeking to install shredded tires as a protective surface request test data from the supplier showing the critical height of the material when it was tested in accordance with ASTM F1292.

It should be recognized that all injuries due to falls cannot be prevented no matter what surfacing material is used.

2. Fall Zones - A fall zone, covered with a protective surfacing material, is essential under and around equipment where a child might fall. This area should be free of other equipment and obstacles onto which a child might fall. Stationary climbing equipment and slides should have a fall zone extending a Minimum of 6' in all directions from the perimeter of the equipment.

Swings should have a fall zone extending a minimum of 6' from the outer edge of the support structure on each side. The fall zone in front and back of the swing should

extend out a minimum distance of twice the height of the swing as measured from the ground to the top of the swing support structure.

Leveling Your Fort During Assembly

- Complete the steps which will be the basic frame of the fort {i.e. four corner posts with base (sand box boards) and deck supports}
- Position in the most level area chosen for the play set, keeping in mind the location and size of the swing beam, ladder, slides, etc. that extend off the fort.
- Once the frame is in the final position, check for vertical and horizontal levelness to determine which side(s) will need to be dug into the ground to level the play set.
- With a shovel, score the ground around the outside edges of the sandbox boards on the 'high' side of the fort. This is the area that will be dug in. Make sure to score deep enough; the scored lines will be your digging template.
- Push the frame off and away from the scored area, far enough to dig and remove dirt to reach the appropriate depth.
- Dig a channel along the scored line(s) for the base of the fort (corner post and sandbox boards) to rest into. Dig the channel(s) to the same level depth. The bottom of the channel(s) should be level to each other so your frame doesn't teeter or rock because the channel(s) are uneven.
- Once you have removed enough grass and dirt, slide/push the frame into the channel(s). Place a level on the vertical and horizontal boards of the frame to determine if enough soil, or too much, was removed.
- Repeat this process until the basic frame is plumb and level and in its final position before completing the rest of the assembly.
- Measure diagonally make sure fort is square.

Important: if you require a channel depth of more than 6", then we recommend you have your play set area professionally graded before completing assembly.

Example play area:

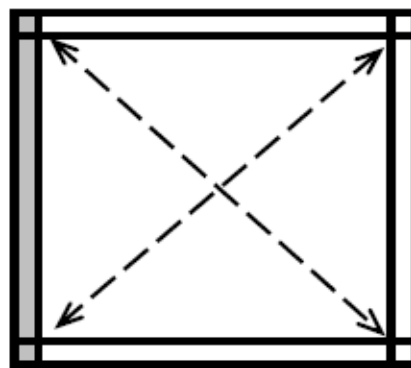
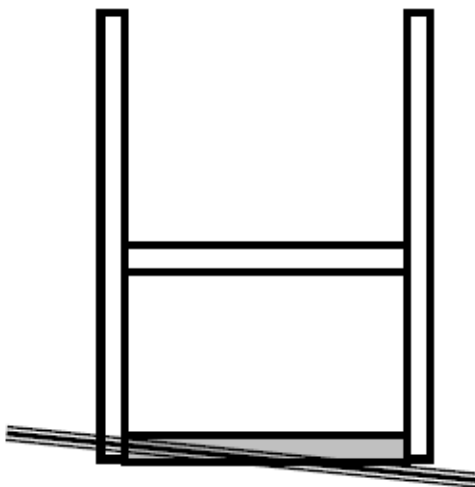

The diagonal measurements should be the same from corner post to corner post. If not, adjust fort so that the distance is equal.

 = Area to be scored and channeled for levelness.

General Info to Review Before Installation

- Depending on your experience, assembly of Gorilla Playsets can take as little as 6 hours up to 24 hours, depending on size, after inventory of parts; therefore, we recommend you set aside a full two days for assembly.
- Identify all of the parts for your play set. Empty each box and lay out boards so you can see each part. Your instruction book will have detailed drawings that will make it easy for you to recognize individual parts. Keep all hardware and metal parts separate from wooden pieces.
- After everything is laid out, check carefully to ensure all parts are present. Make sure there are no broken boards.
- Find an area to sort your hardware. It is best to open the hardware on a solid surface so that you do not lose any pieces in the grass. This will save time and familiarize you with all the different pieces in the hardware bag.
- Important note: Wood has some natural defects such as knots, surface cracks, etc... We reject parts that are structurally defective. We use a high quality lumber in our structures; however, you should inspect each part for splinters or rough spots and sand them smooth to prevent injury.
- After familiarizing yourself with all of the components, read all instructions thoroughly. Reading instructions after you have studied the parts will help you understand more clearly the installation process, and help to eliminate unnecessary mistakes.
- Pay close attention to the diameter and length of each bolt and screw.
- Never tighten hardware completely at first. It helps to have some adjustment for bolt alignment while you are attaching parts together. After everything is square, tighten each joint.
- After the main unit is assembled it is critical that the floor is **level** and **square**. If the main frame is not level, the walls and floor will be out of square.
- After you complete installation, make sure every bolt, screw, and nut is tight, and every board is secure. Wood will expand and contract with the seasons.
- Check all bolt connections and swing hangers seasonally.
- Place the set on level ground, not less than 6ft from any structure or obstruction such as a fence, garage, house, overhanging branches, laundry lines, or electrical wires.

This page is a list of definitions and explanations used throughout our instructions to aid you in the assembly of your play set.

Offset Holes- Throughout the installation procedures we will refer to parts with offset holes. This refers to the orientation of the holes on the board. An offset hole is one that is closer to one side than it is to the other or in other words, it is not centered on the board. In the procedures you will be instructed to attach the boards with the holes offset up or with the holes offset down. This refers to which side of the board the hole/holes should be closer to. Offset holes up= hole/holes will be closer to the top of the board. Offset holes down= hole/holes will be closer to the bottom of the board. Note: some parts do not have offset holes, but instead the holes are on center. Therefore there will not be any reference to how to offset these parts.

EXAMPLE OF OFFSET HOLES DOWN



EXAMPLE OF OFFSET HOLES UP



Counter-sunk holes- Many of the parts that will be used have counter-sunk holes. A counter-sunk hole is one that surrounds one side of a thru hole, but does not extend through the wood it's self. When using a counter-sunk hole the bolt will be inserted through the thru hole. In some cases the bolt head with a washer will occupy the counter-sunk hole. In other cases a nut with a washer will occupy the counter-sunk hole.

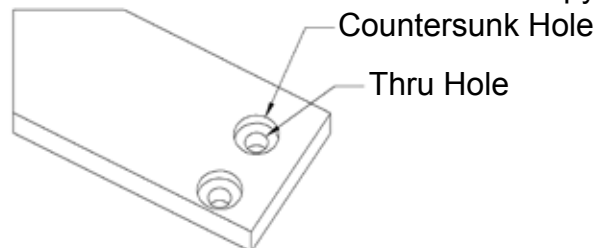

Lag Screws- Lag screws are used in the construction of our play sets to enhance the structural integrity of the unit. There will not be predrilled holes in the post for lag screw installation. Lag screws are self-tapping, though if you are using a manual socket wrench it may be necessary to tap the head of the lag screw with a hammer. You should also be sure to tighten the lag screws completely. Power tools such as an impact wrench or power drill should have enough torque to drive the lag screws without using a hammer, but make sure not to over tighten as this can cause the threads to “strip out” in the post.

Common Installation Practice Installing T-nuts

When installing T-nuts into the wood, use a smooth faced hammer to set the face of the T-nut flush into the wood

Corner Post

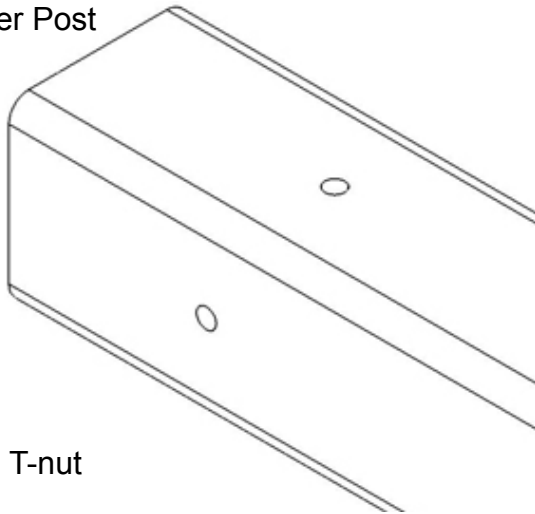

T-nut

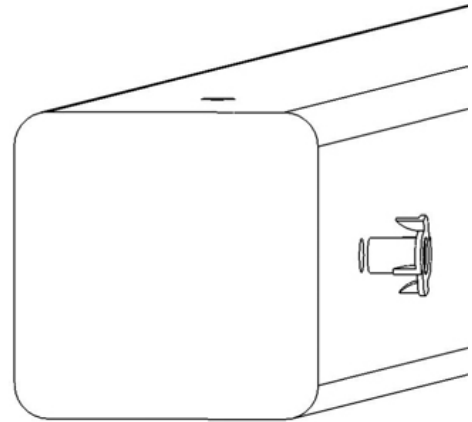

Insert the barrel of the T-nut into the predrilled hole. Using a smooth faced hammer, drive the T-nut until the face of the T-nut is flush to the wood.

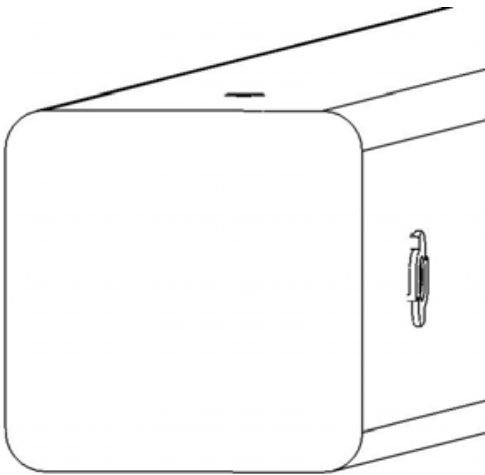

This picture shows the T-nut insert and installed flush to the wood.

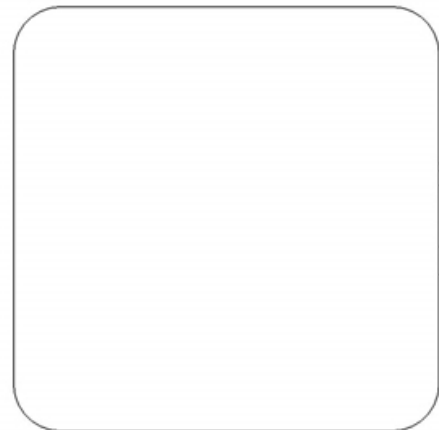

This picture shows an end view of the T-nut insert and installed flush to the wood.

WARNING: DO NOT EMBED THE TOP OF THE T-NUT INTO THE FACE OF THE WOOD

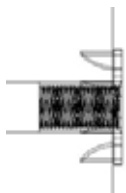

Cross Section end views, you are looking at an Xray view of the post and T-nut. The barrel of the T-nut is in the corner post the line is the face of the wood.

Please familiarize yourself with the manual, parts/components and general construction process of your new playset before getting started.

SITE PLAN:

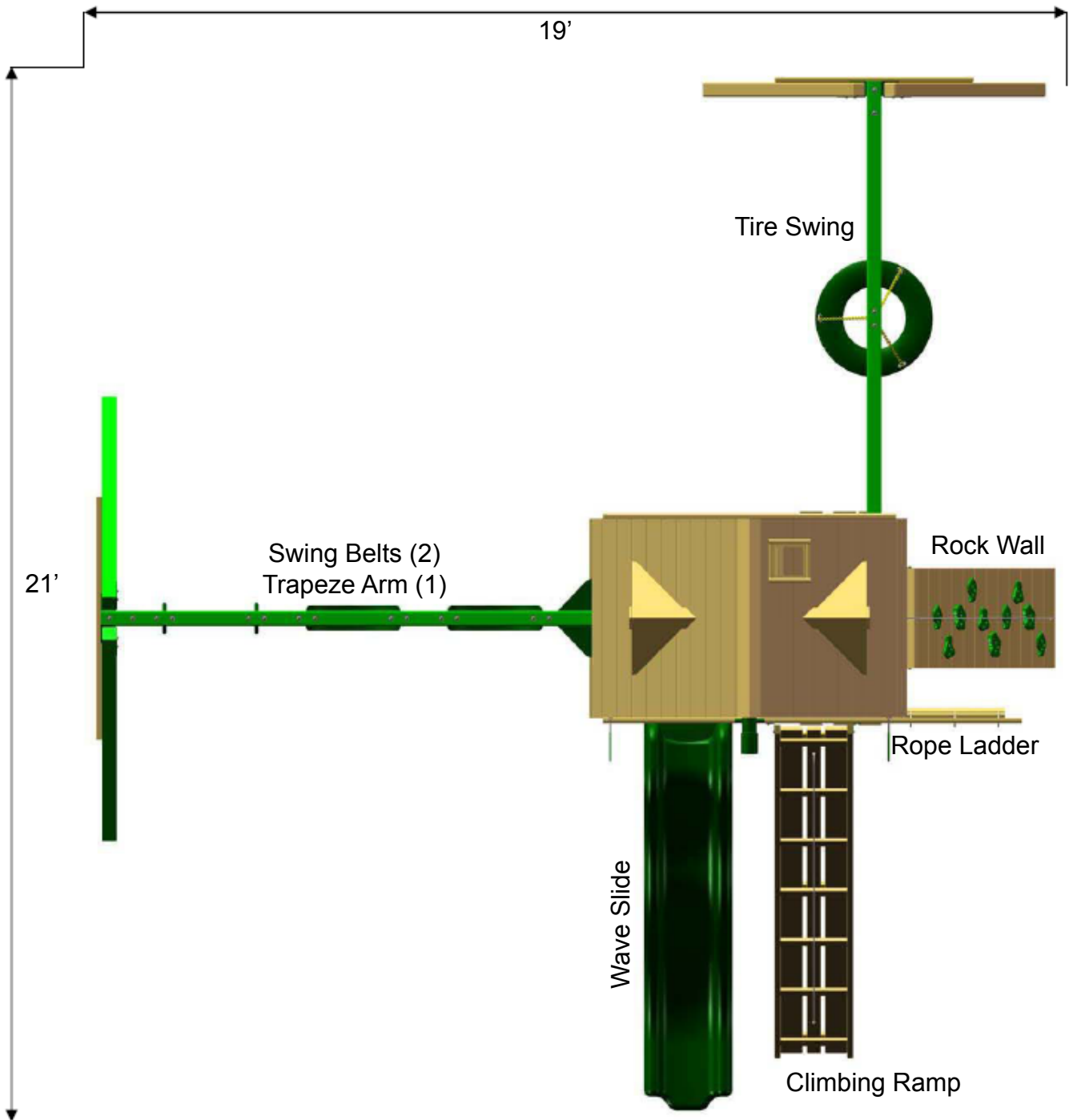

Playset height: 11'

Approximate assembly time: 8-10 Hours

6 foot unobstructed safety perimeter around playset recommended

REQUIRED TOOL LIST:

- ___ Standard or Cordless Drill w/ Phillips Bit (#2 square bit provided)
- ___ 1/8" Drill Bit
- ___ 3/8" Drill Bit
- ___ 7/8" Paddle Bit
- ___ 1/2" Wrench and Socket
- ___ 1/2" Deep Well Socket
- ___ 9/16" Deep Well Socket
- ___ 9/16" Wrench and Socket
- ___ Level
- ___ Tape Measure
- ___ Extension Cord (if using standard drill)
- ___ Hammer
- ___ Rubber Mallet
- ___ Pencil
- ___ Locking Pliers (Vise Grips)
- ___ Shovel

KIT CONTENTS - Swings, Slides, Accessories:

- (Qty) Description
- ___ (2) Swingbelts w/ Chains
- ___ (1) 10ft. Wave Slide
- ___ (1) Frontier Assembly Manual
- ___ (10) Rock Wall Grips (assorted colors)
- ___ (1) Trapeze Swing
- ___ (1) Tire Swing
- ___ (1) Tic-Tac-Toe Panel
- ___ (1) Telescope
- ___ (2) 10 ft. Rope
- ___ (2) Safety Handles
- ___ (1) Rope Ladder
- ___ (2) Flags

Fort Hardware & Swing Beam Hardware:

see following pages

Wood Components:

see following pages

READ! VERY IMPORTANT!

If you are missing parts or have questions regarding the installation of our quality product PLEASE call us directly at the factory **(1-800-882-0272)**. Our trained staff will be happy to assist you.

**Customer service hours:
Monday thru Friday 8AM – 5PM EST
E-mail: custsrv@gorillaplaysets.com**

Use the ruler to the right to measure your bolts and screws. Picture views shown below are 1:1 scale and can be used to match bolt and screw sizes.



5/16 x 7-1/2"
Hex Bolt
Qty: 2



5/16 x 4-1/2"
Hex Bolt
Qty: 30



5/16 x 1-1/2"
Hex Bolt
Qty: 8

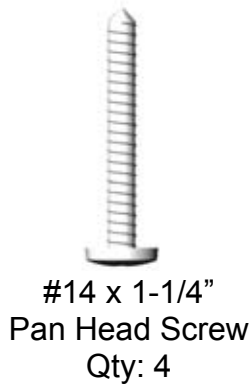

5/16" Tee Nut
Qty: 40



3/8" Lock Nut
Qty: 23



Torque Washer
Qty: 21



1/2" Washer
Qty: 2



3/8" Washer
Qty: 46



5/16" Washer
Qty: 62

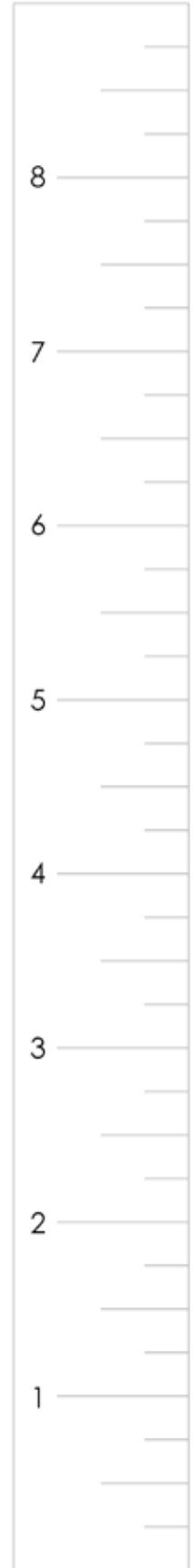

Use the ruler to the right to measure your bolts and screws. Picture views shown below are 1:1 scale and can be used to match bolt and screw sizes.



3/8 x 9"
Carriage Bolt
Qty: 1



3/8 x 7"
Carriage Bolt
Qty: 20

5/16 x 3-1/2"
Hex Lag Screw
Qty: 22



3/8 x 3-1/2"
Hex Lag Screw
Qty: 23



3/8 x 3-1/2"
Carriage Bolt
Qty: 2



5/16 x 4"
Eye Bolt Lag
Qty: 3



#2 Square
Drill Bit
Qty: 1





Plastic
Bolt Cap
Qty: 23

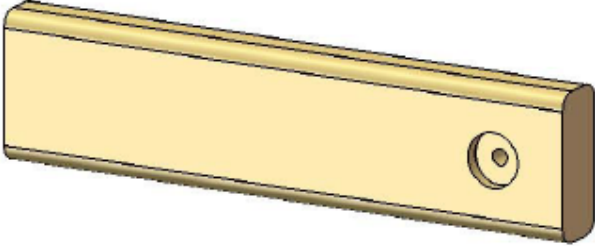
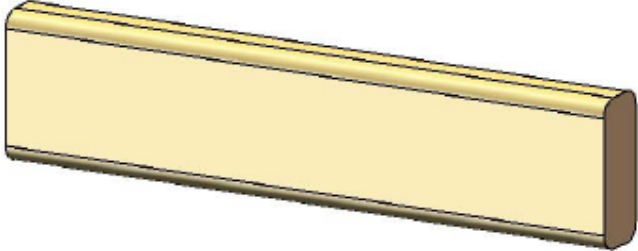
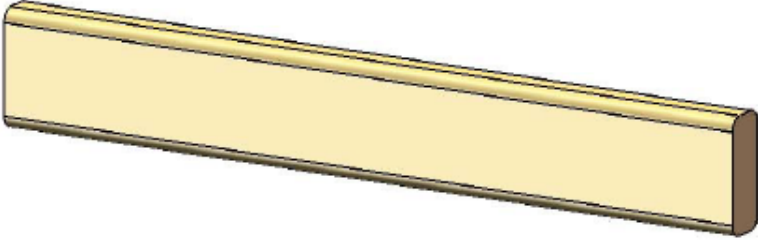
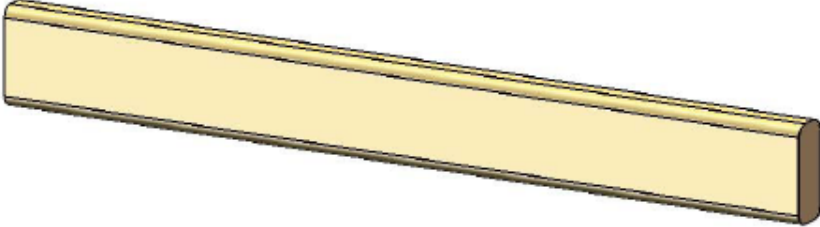
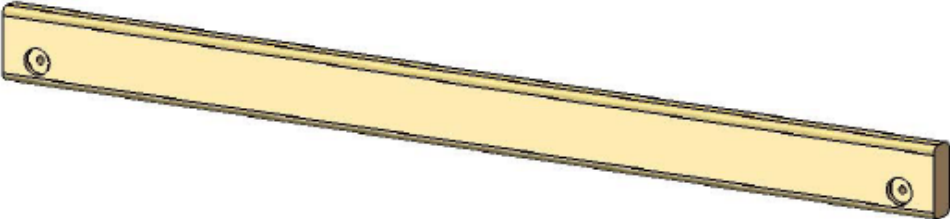
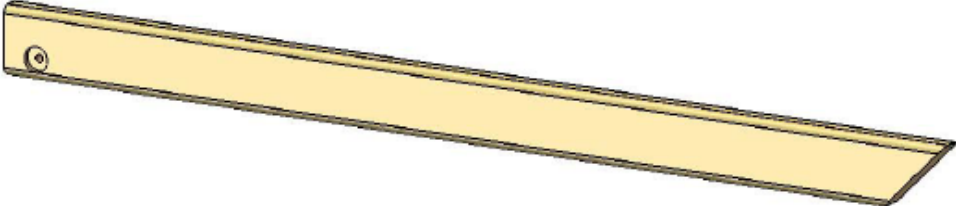

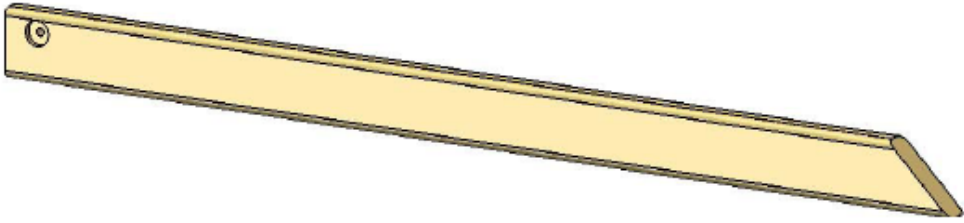
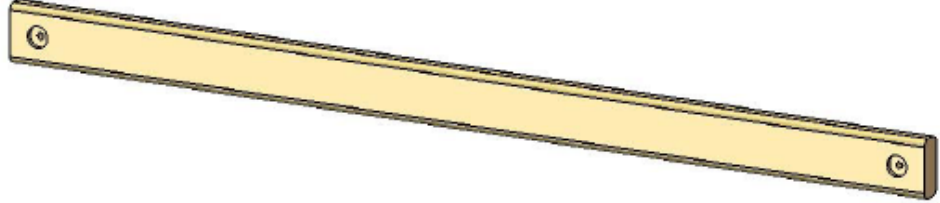
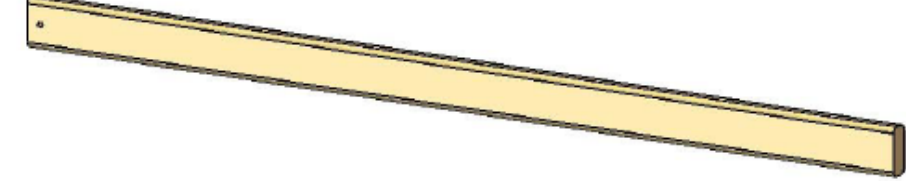
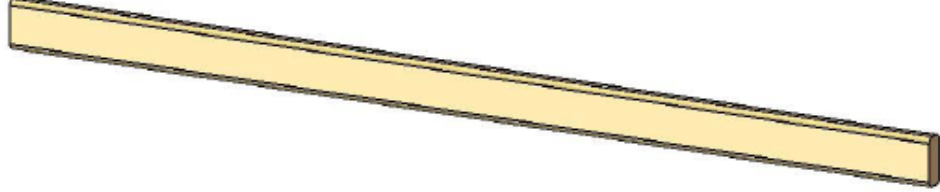
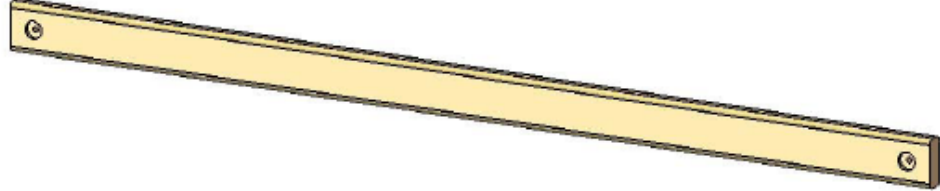
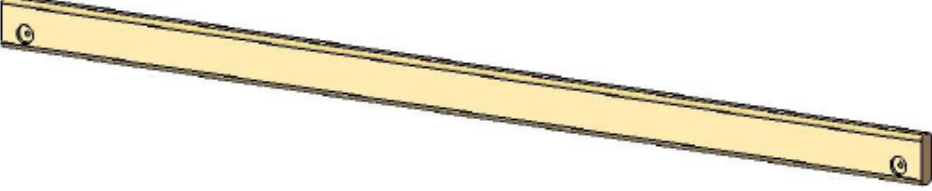

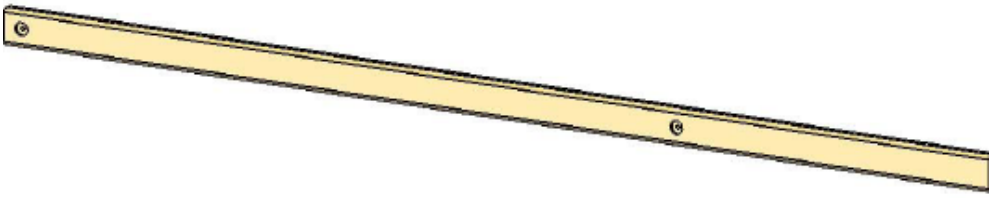
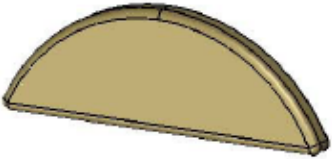
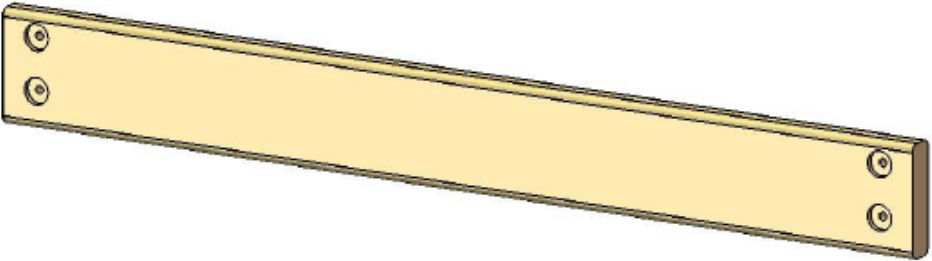
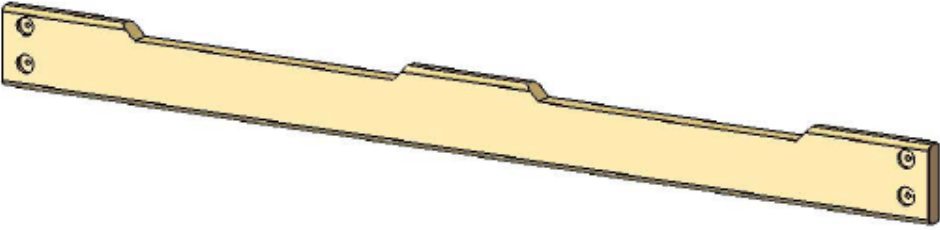
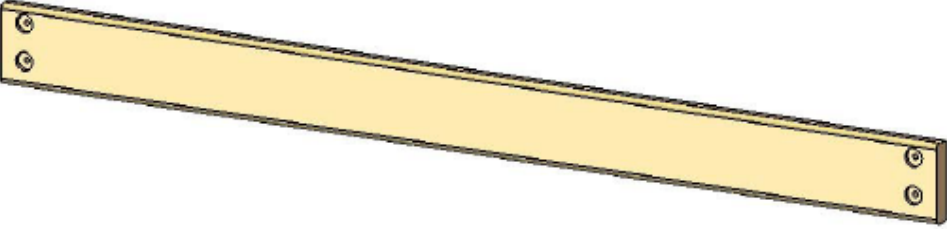
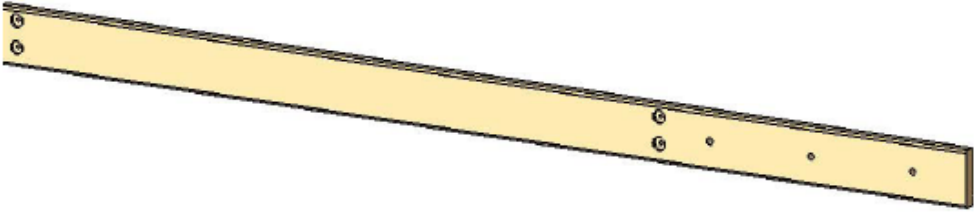
Picture	Description	Qty.
	2 x 4 x 14" Bottom Panel Board	2
	2 x 4 x 15" Picnic Table Support	2
	2 x 4 x 23" Picnic Table Bench Support	2
	2 x 4 x 30" Picnic Table Vertical Support	2
	2 x 4 x 47-1/2" Safety Board/ Top Panel Board	3
	2 x 4 x 51" Roof Support Board (Left)	2

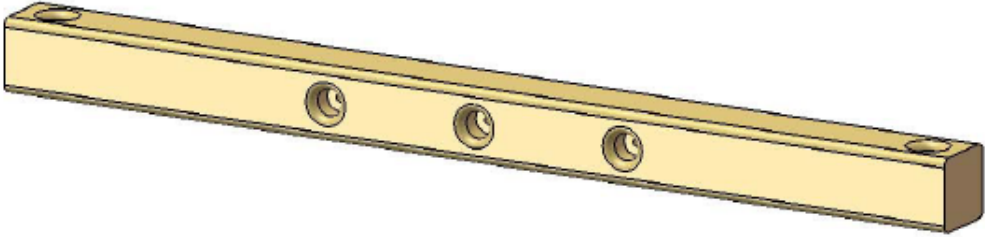
Picture	Description	Qty.
	2 x 4 x 51" Roof Support Board (Right)	2
	2 x 4 x 58" Swing Beam Cross Member	1
	2 x 4 x 66" Rock Wall Side	2
	2 x 4 x 70" Center Deck Support	1
	2 x 4 x 70" Deck Support	2
	2 x 4 x 70" Rear Top Panel Board	1

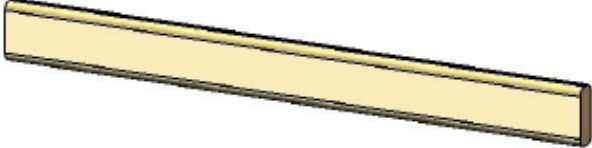
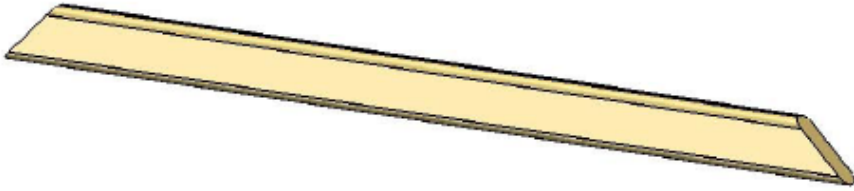
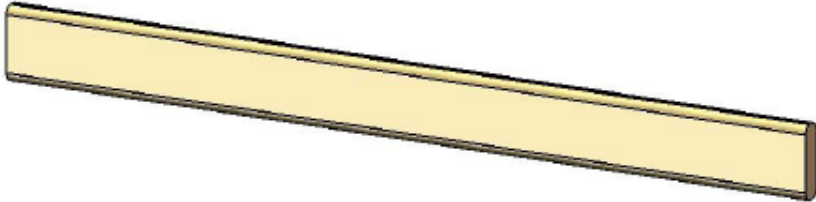

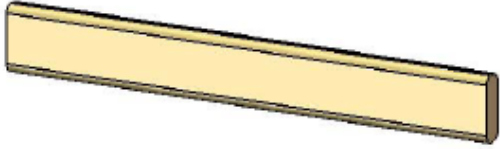
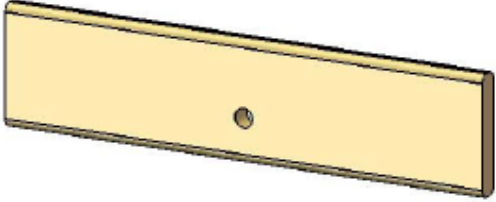
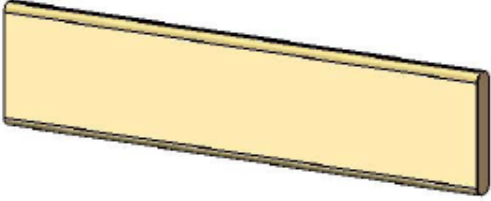
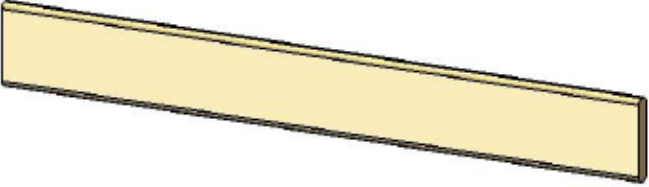
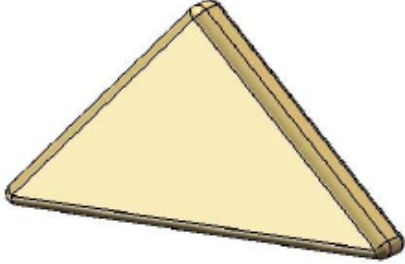
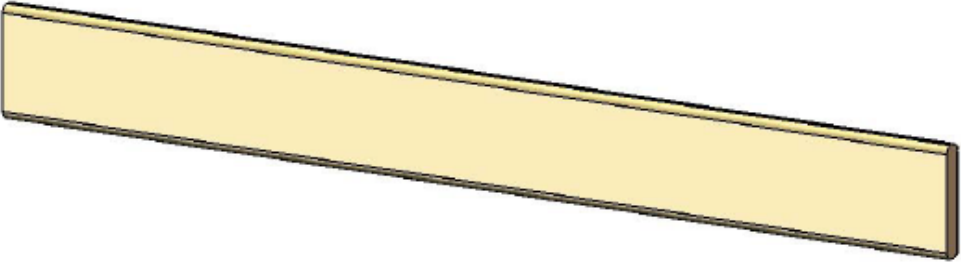
Picture	Description	Qty.
	2 x 4 x 100" Rope Ladder Support	1
	2 x 6 x 16" Sun	2
	2 x 6 x 47-1/2" Bottom Panel/ Sandbox Board	4
	2 x 6 x 70" Front Face Board	1
	2 x 6 x 70" Bottom Panel/ Sandbox Board	2
	2 x 6 x 100" Rope Ladder Runner	1

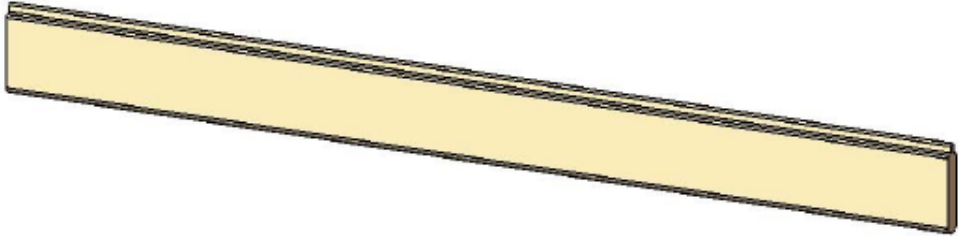
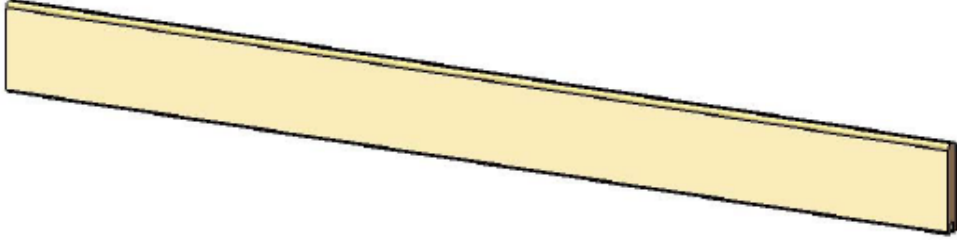
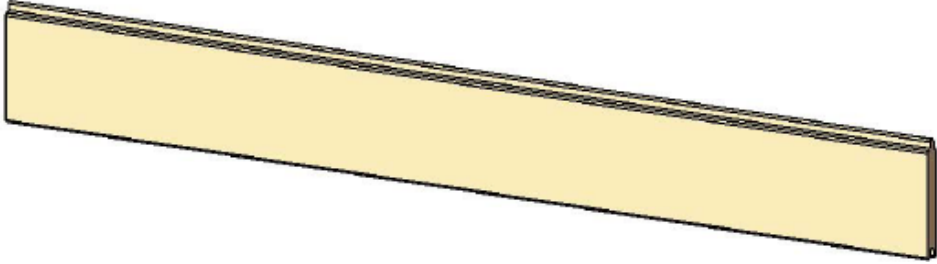
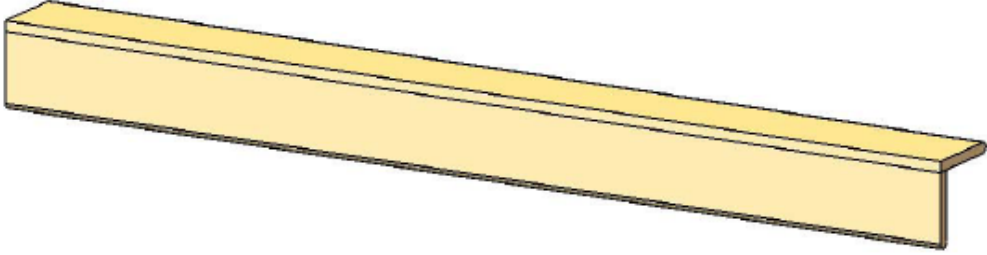

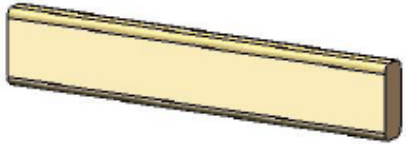

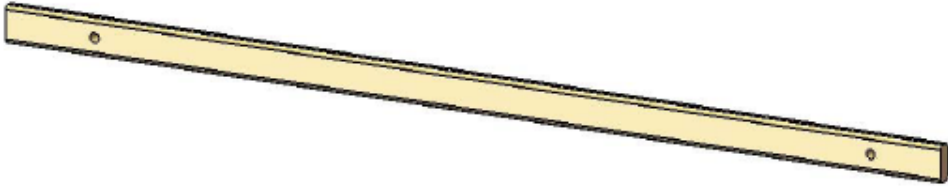
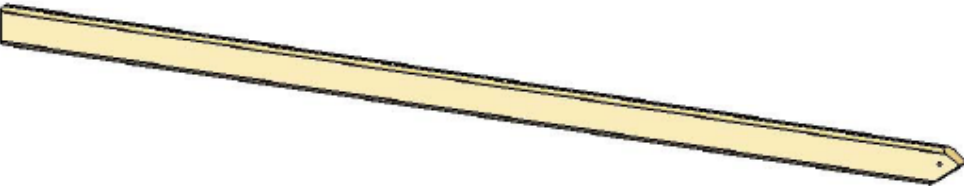
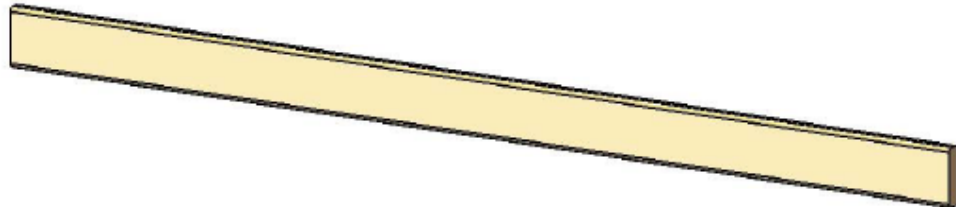
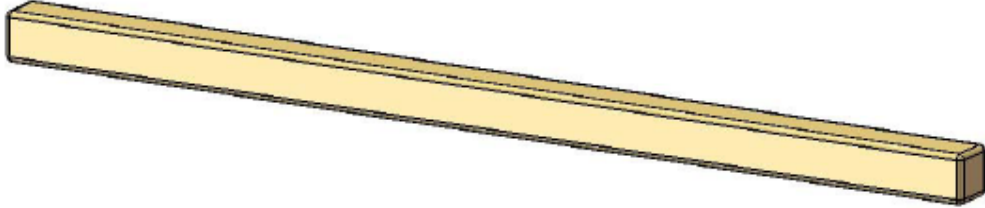
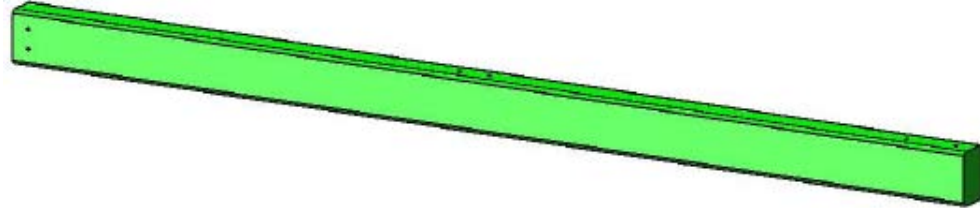
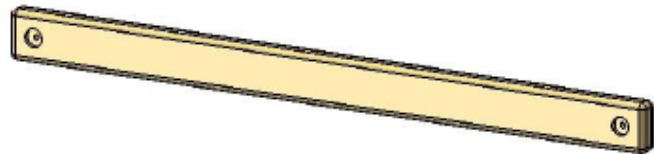
Picture	Description	Qty.
	4 x 4 x 47-1/2" Swing Beam Support	1
	5/4 x 1-1/2 x 10" Small Ray	12
	5/4 x 1-1/2 x 16" Large Ray	2
	5/4 x 2-5/8 x 28-1/2" Panel Slat	27
	5/4 x 2-5/8 x 42" Sun Support	2
	5/4 x 4 x 40-1/2" Deck Spacer	2

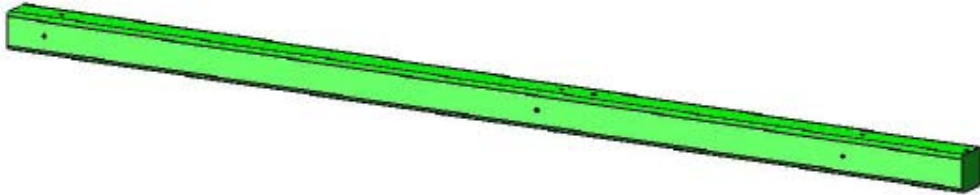
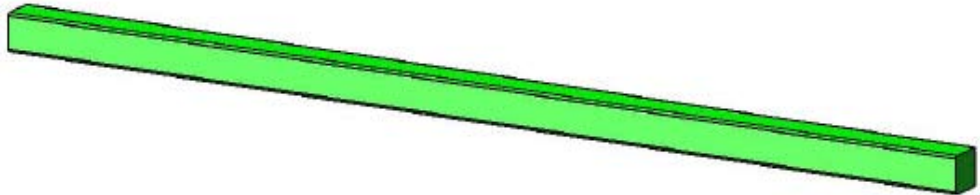
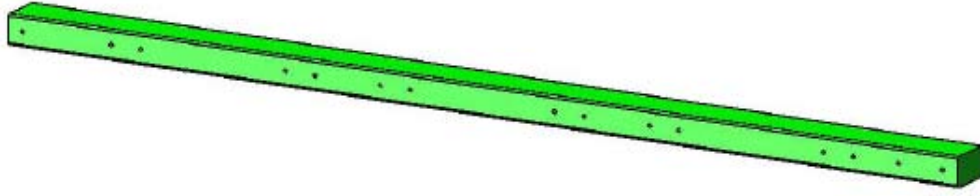

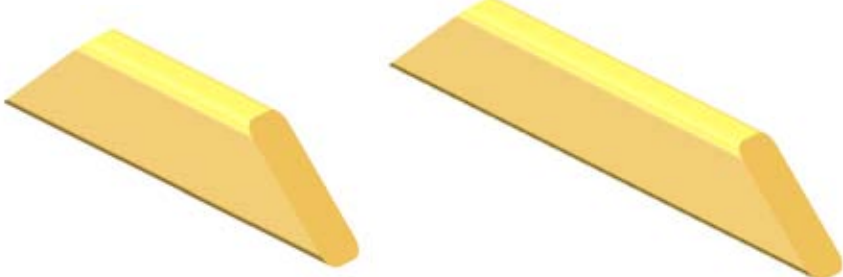
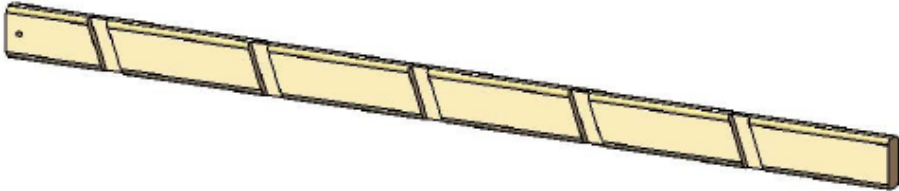

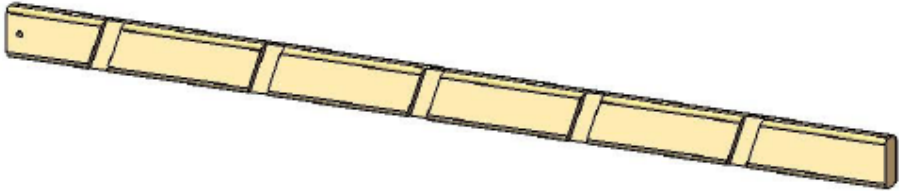
Picture	Description	Qty.
	5/4 x 3 x 23-7/8" Rock Wall Cap	1
	5/4 x 6 x 23-7/8" Bottom Rock Wall Board	1
	5/4 x 6 x 23-7/8" Rock Wall Board	11
	5/4 x 6 x 47-3/8" Deck Board	11
	5/4 x 10" Roof Peak Support	2
	5/4 x 6 x 51" Picnic Table Seat and Top	3





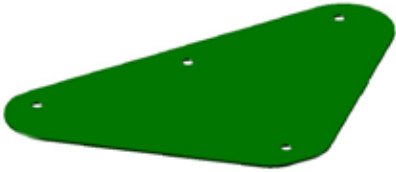

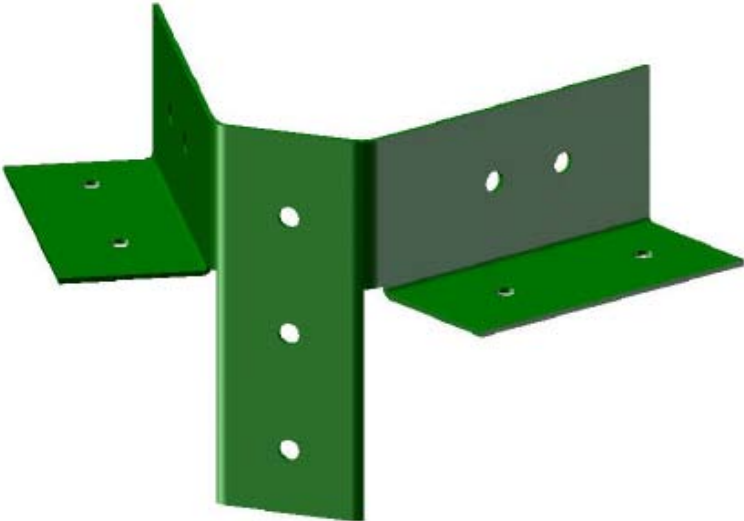
Picture	Description	Qty.
	1 x 4 x 47-1/2" Tongue Only Roof Finisher	2
	1 x 4 x 47-1/2" Groove Only Roof Starter	2
	1 x 6 x 47-1/2" Tongue and Groove Roof Board	18
	47-1/2" Roof Peak	1
	2 x 2 x 16" Ramp Floor Support	7
	2 x 4 x 18-3/4" Ramp Support	3





Picture	Description	Qty.
	2 x 4 x 94" Ramp Middle Floor Board	1
	2 x 4 x 96" Ramp Side	2
	2 x 6 x 94" Ramp Floor Board	2
	4 x 4 x 72" Tire Swing Leg	2
	4 x 6 x 108" Plastic Coated Tire Swing Beam	1
	2 x 4 x 47-1/2" Tire Swing Cross Member	1

Picture	Description	Qty.
	4 x 4 x 96" Plastic Coated Corner Post	4
	4 x 4 x 108" Plastic Coated Swing Leg	2
	4 x 6 x 120" Plastic Coated Swing Beam	1
 <p data-bbox="776 1108 1052 1226">Note: These items will not be used for your playset.</p>	2 x 4 x 17 Ladder Step 5/4 x 3 x 18-1/2" Ladder Back	5 1
	2 x 4 x 13" Angle Support 2 x 4 x 18" Angle Support	4 4
	2 x 4 x 66" Left Ladder Side Note: This item will not be used for your playset.	1

Picture	Description	Qty.
	<p>2 x 4 x 66" Right Ladder Side</p> <p>Note: This item will not be used for your playset</p>	<p>1</p>
	<p>10' Extreme Wave Slide</p>	<p>1</p>
	<p>Rope Ladder Assembly</p>	<p>1</p>
	<p>Swings w/Chains</p> <p>Trapeze Bar w/ Chains</p>	<p>2</p> <p>1</p>

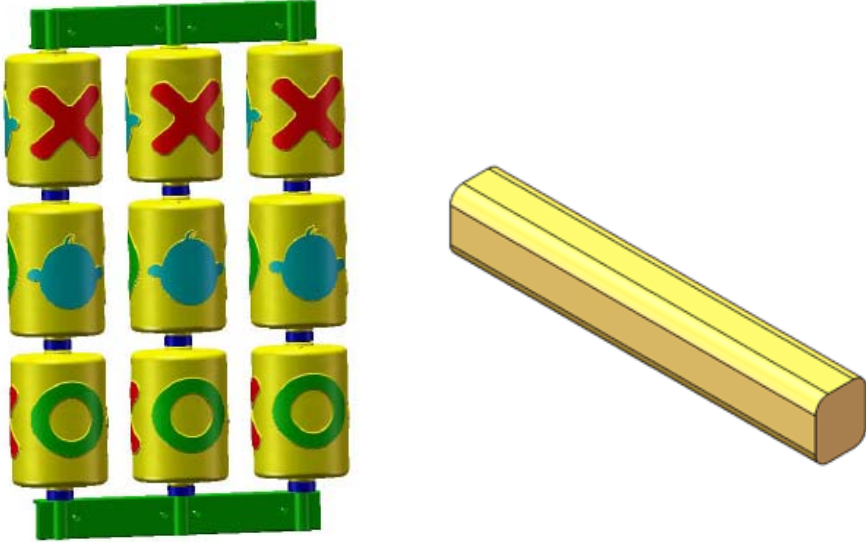
Picture	Description	Qty.
	Swing Plate	1
	Climbing Rocks	10
	A Frame Swing Leg Bracket	2
	Iron Ductile Swing Hangers	6
	Telescope	1

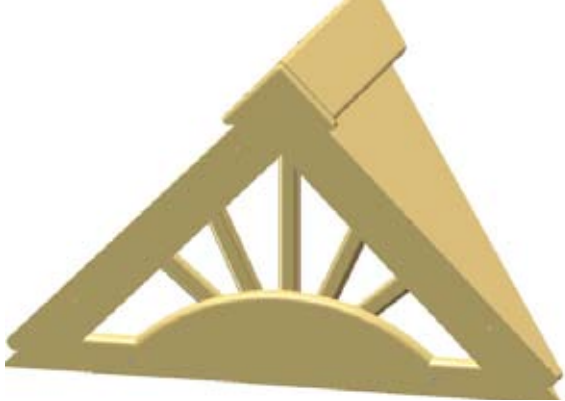
Picture	Description	Qty.
	10' Rope	2
	Plastic Flag Kit	2
	90° Green Bracket	4
	Spring Clamp	9
	Tire Swing Swivel	1
	Tire Swing w/ Chains	1

Picture	Description	Qty.
	<p>Tic-Tac-Toe Assembly</p> <p>1-3/8 x 1-5/8 x 10-1/2" Tic-Tac-Toe Board</p>	<p>1</p> <p>2</p>
	<p>Safety Handles (pair)</p>	<p>1</p>
	<p>Unassembled Dormer</p>	<p>2</p>
	<p>Unassembled Chimney</p>	<p>1</p>

Step 1: Attaching T-Nuts to the Corner Posts

- 1: This step is critical to building the fort properly. If any mistakes are made here, you will need to dis-assemble and then re-assemble to make your corrections.
- 2: Make sure holes are free of any obstructions. Use a bolt to clean out any debris.
- 3: Lay out each of the 4 x 4 x 96" Corner Posts in the area you intend on building the fort.
- 4: Use the diagram below to correctly identify and orient the necessary direction the posts should face.
- 5: Use a hammer to seat the t-nuts after inserting them into the holes shown in the diagram below.
- 6: The barrel of the t-nut should go in the hole first. Hammer the t-nut until it is flush/ almost flush to the Corner Posts

Note: Letters A, B, C, D are used for reference. Your posts are NOT pre-labeled.

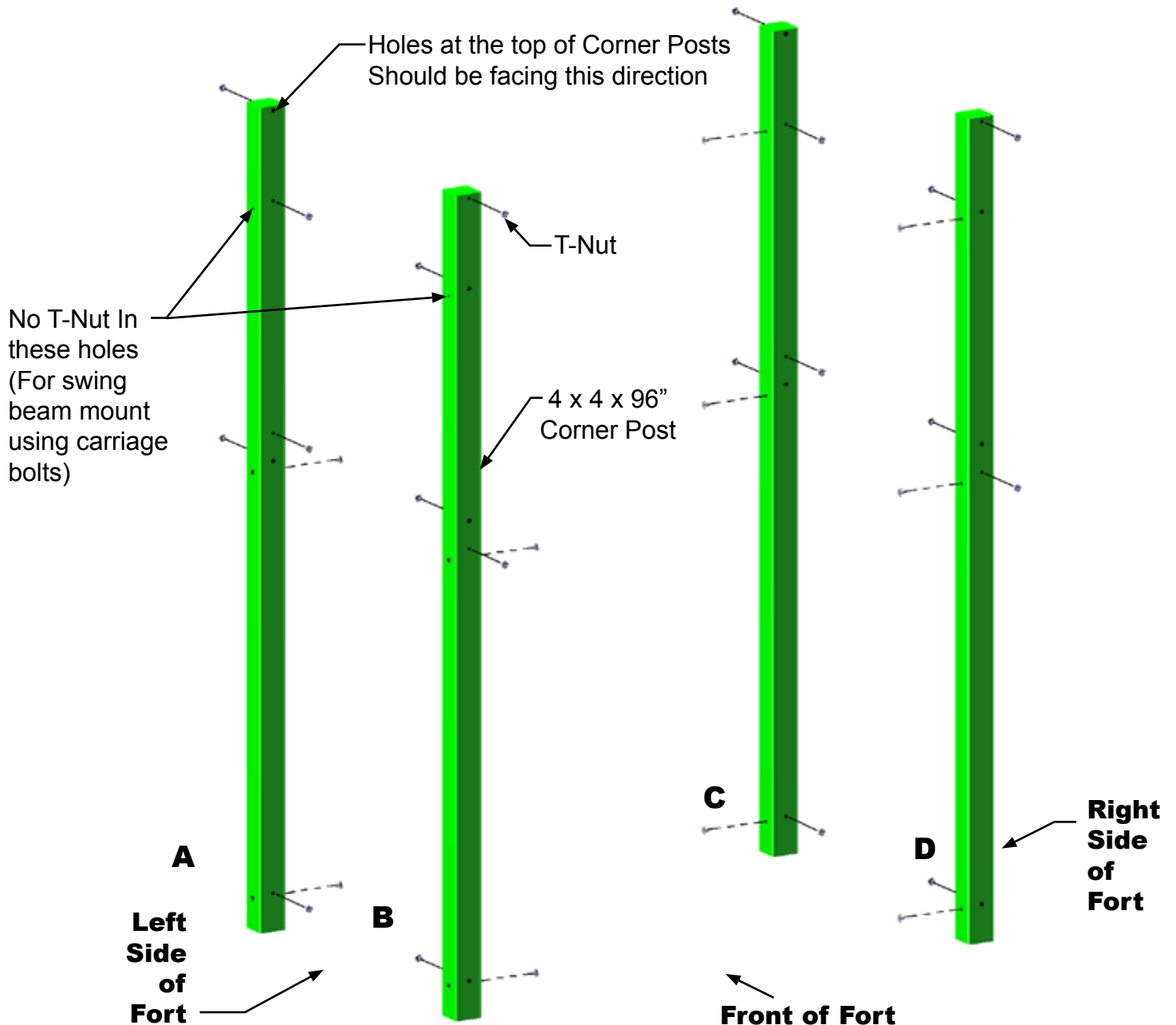

Step 2: Assembling the Right Side Frame

- 1: Lay the 2 x 6 x 47-1/2" Sandbox Board on top of the right side Corner Posts at the bottom of the Corner Posts. The offset holes in the Sandbox Board must face downward.
- 2: Use 5/16 x 4-1/2" hex bolts and 5/16" washers to attach the top holes of the Sandbox Board to the t-nuts installed on the Corner Posts. The bottom holes will be used later.
- 3: Lay the 2 x 6 x 47-1/2" Bottom Panel Board on top of the right side Corner Posts in the middle of the Corner Posts. The offset holes in the Bottom Panel Board must face downward.
- 4: Use 5/16 x 4-1/2" hex bolts and 5/16" washers to attach the bottom holes of the Bottom Panel Board to the t-nuts installed on the Corner Posts. The top holes will be used later.
- 5: Lay the 2 x 4 x 47-1/2" Top Panel Board on top of the right side Corner Posts. The offset holes in the Top Panel Board must face downward.
- 6: Use 5/16 x 4-1/2" hex bolts and 5/16" washers to attach the top holes of the Top Panel Board to the t-nuts installed on the Corner Posts.
- 7: Use a 7/8" paddle bit to drill a hole in the center of the Top Panel Board. This is the only time you will need this drill bit in the assembly. You may put it away after drilling the hole.
- 8: Do not install lag screws at this time.

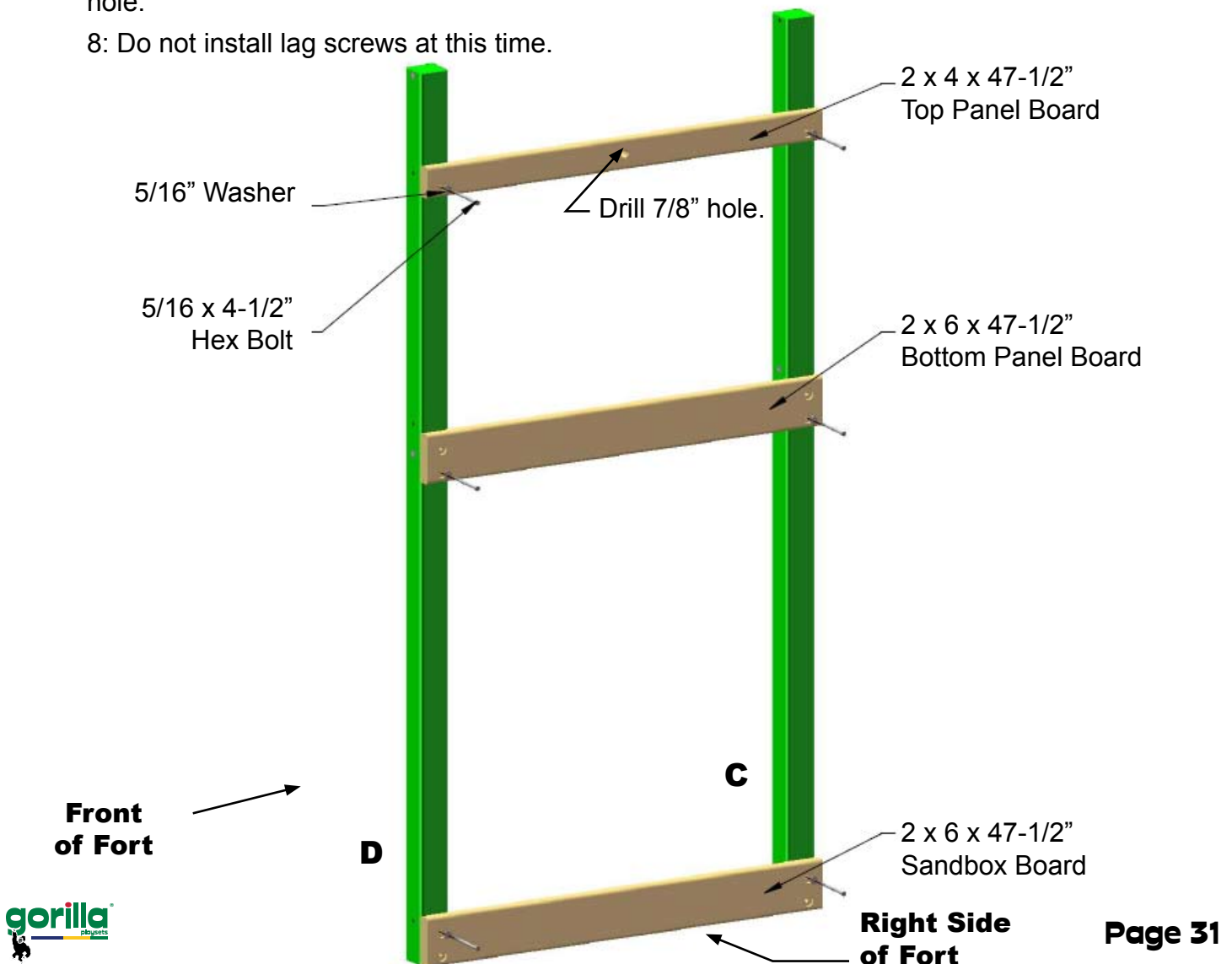

Step 3: Assembling the Left Side Frame

- 1: Lay the 2 x 6 x 47-1/2" Sandbox Board on top of the left side Corner Posts at the bottom of the Corner Posts. The offset holes in the Sandbox Board must face downward.
- 2: Use 5/16 x 4-1/2" hex bolts and 5/16" washers to attach the top holes of the Sandbox Board to the t-nuts installed on the Corner Posts. The bottom holes will be used later.
- 3: Lay the 2 x 6 x 47-1/2" Bottom Panel Board on top of the left side Corner Posts in the middle of the Corner Posts. The offset holes in the Bottom Panel Board must face downward.
- 4: Use 5/16 x 4-1/2" hex bolts and 5/16" washers to attach the bottom holes of the Bottom Panel Board to the t-nuts installed on the Corner Posts. The top holes will be used later.
- 5: Lay the 4 x 4 x 47-1/2" Swing Beam Support on top of the left side Corner Posts. The three countersunk holes in the middle of the Swing Beam Support must face downward.
- 6: Find two torque washers. Place a 7" carriage bolt inside the torque washer, making sure that the teeth are facing in the same direction as the threads of the carriage bolt. Place the torque washer/carriage bolt assembly into the holes of the Corner Post so that the head of the carriage bolt faces what will be the inside of the fort. Use a hammer to set the torque washer into the Corner Post.
- 7: Attach the Swing Beam Support as shown in Detail 1.
- 8: You may need to use vise grips to hold carriage bolts in place when installing.

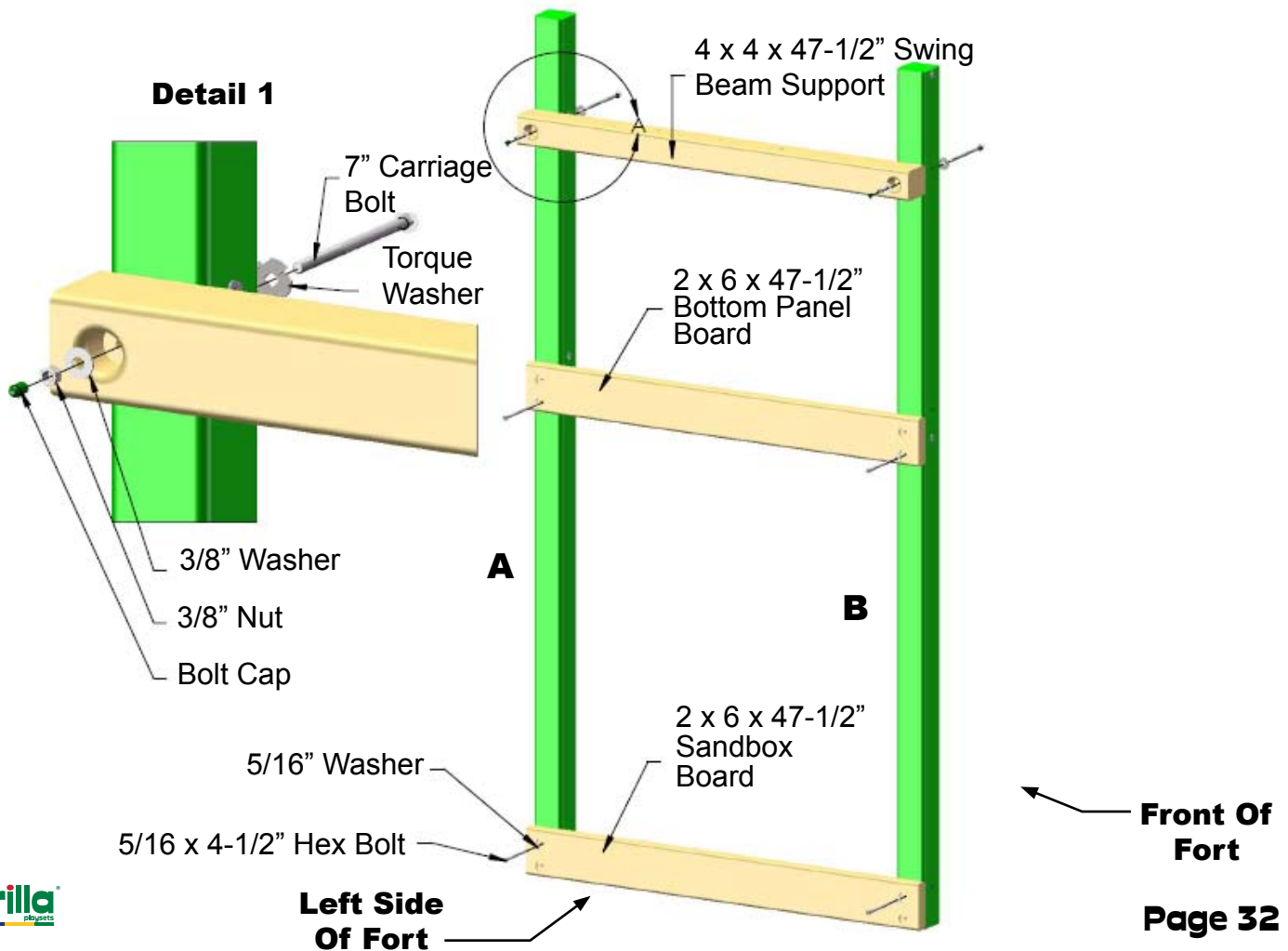

Step 4: Deck Supports

You will need an extra person for this step.

1: With help, stand up the left and right side frame assemblies.

2: Fasten the 2 x 4 x 70" Deck Supports to the holes at 54-3/4" with 5/16 x 4-1/2" hex bolts and 5/16" washers from the inside of the fort

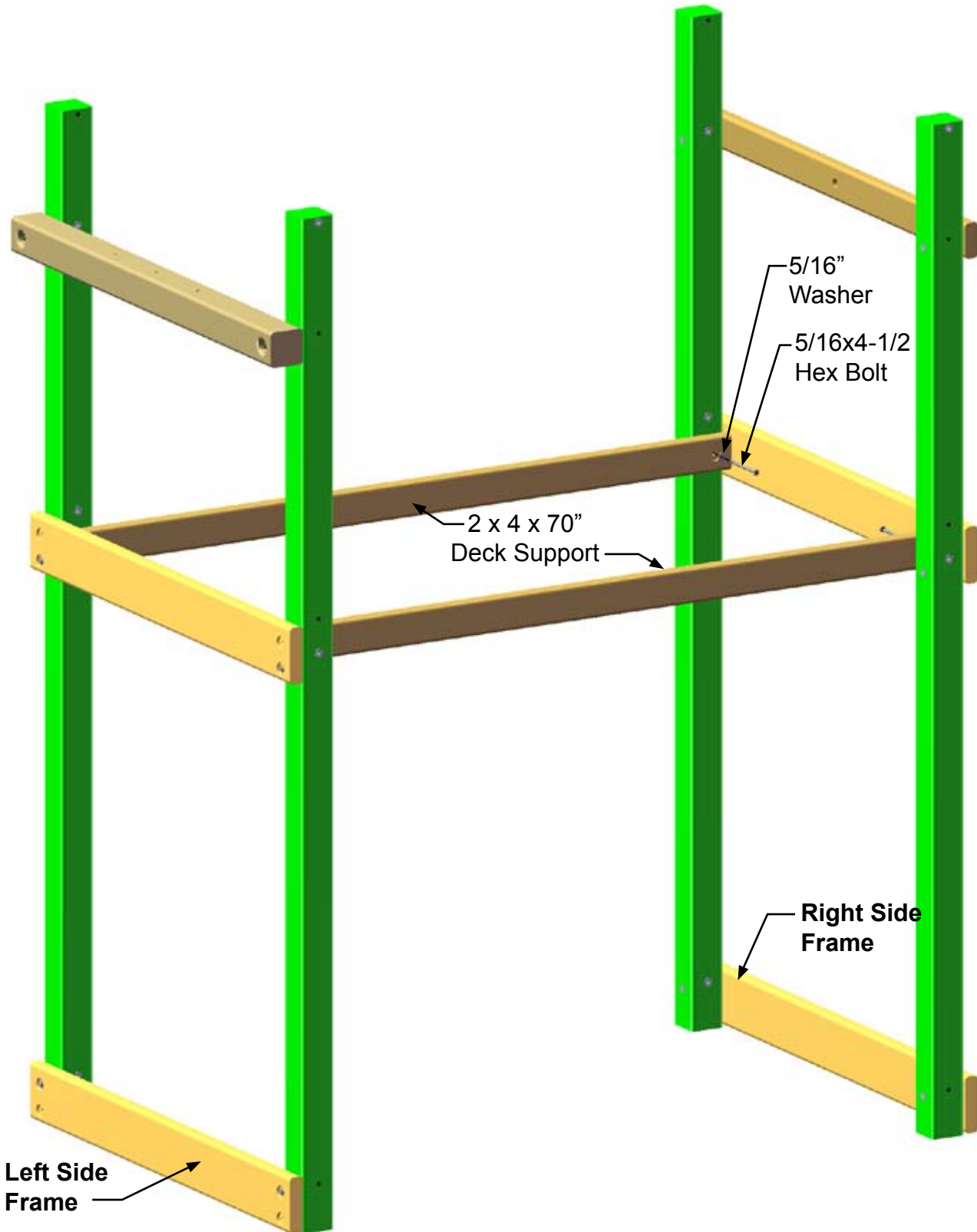

Step 5: Front frame assembly

- 1: Place the 2 x 6 x 100" Rope Ladder Runner on the front of the Corner Posts at the bottom. The offset holes in the Rope Ladder Runner should face up.
- 2: Use 5/16 x 4-1/2" hex bolts and 5/16" washers to attach the top holes of the Rope Ladder Runner to the t-nuts installed on the Corner Posts. The bottom holes will be used later.
- 3: Place the 2 x 6 x 70" Front Face Board with notches on the front of the Corner Posts. The offset holes in the Front Face Board should face up.
- 4: Use 5/16 x 4-1/2" hex bolts and 5/16" washers to attach the top holes of the Front Face Board to the t-nuts installed on the Corner Posts. The bottom holes will be used later.
- 5: Place the 2 x 4 x 100" Rope Ladder Support on the front of the Corner Posts. The offset holes in the Rope Ladder Support should face up.
- 6: Use 5/16 x 4-1/2" hex bolts and 5/16" washers to attach the top holes of the Rope Ladder Support to the t-nuts installed on the Corner Posts.

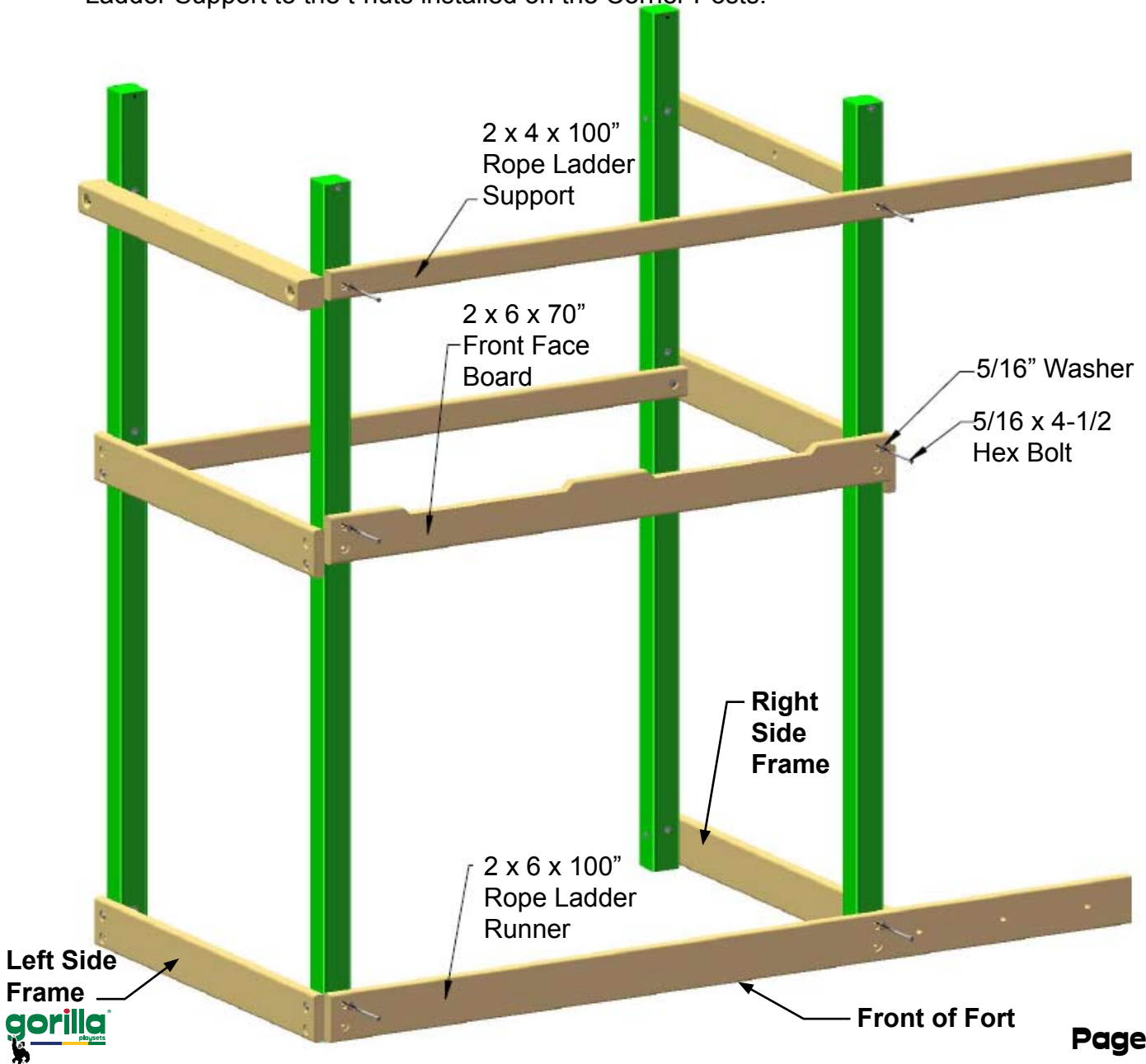

Step 6: Rear frame assembly

- 1: Place the 2 x 6 x 70" Sandbox Board on the rear of the Corner Posts. The offset holes in the Sandbox Board must face up.
- 2: Use 5/16 x 4-1/2" hex bolts and 5/16" washers to attach the top holes of the Sandbox Board to the t-nuts installed on the Corner Posts. The bottom holes will be used later.
- 3: Place the 2 x 6 x 70" Bottom Panel Board on the front of the Corner Posts. The offset holes in the Bottom Panel Board must face up.
- 4: Use 5/16 x 4-1/2" hex bolts and 5/16" washers to attach the top holes of the Bottom Panel Board to the t-nuts installed on the Corner Posts. The bottom holes will be used later.
- 5: Place the 2 x 4 x 70" Rear Top Panel Board on the front of the Corner Posts. The offset holes in the Top Panel Board must face up.
- 6: Use 5/16 x 4-1/2" hex bolts and 5/16" washers to attach the top holes of the Rear Top Panel Board to the t-nuts installed on the Corner Posts.

7: Place the frame in its final position and follow the procedures at the front of the manual to level and square the structure. Once the frame is level, square, and set into position; go back and insert the 5/16 x 3-1/2" lag screws and 5/16" washers in all of the remaining holes of the 2 x 6 parts. Note: there will not be any predrilled holes in the corner posts for the lag screws. Lag screws are self-tapping.

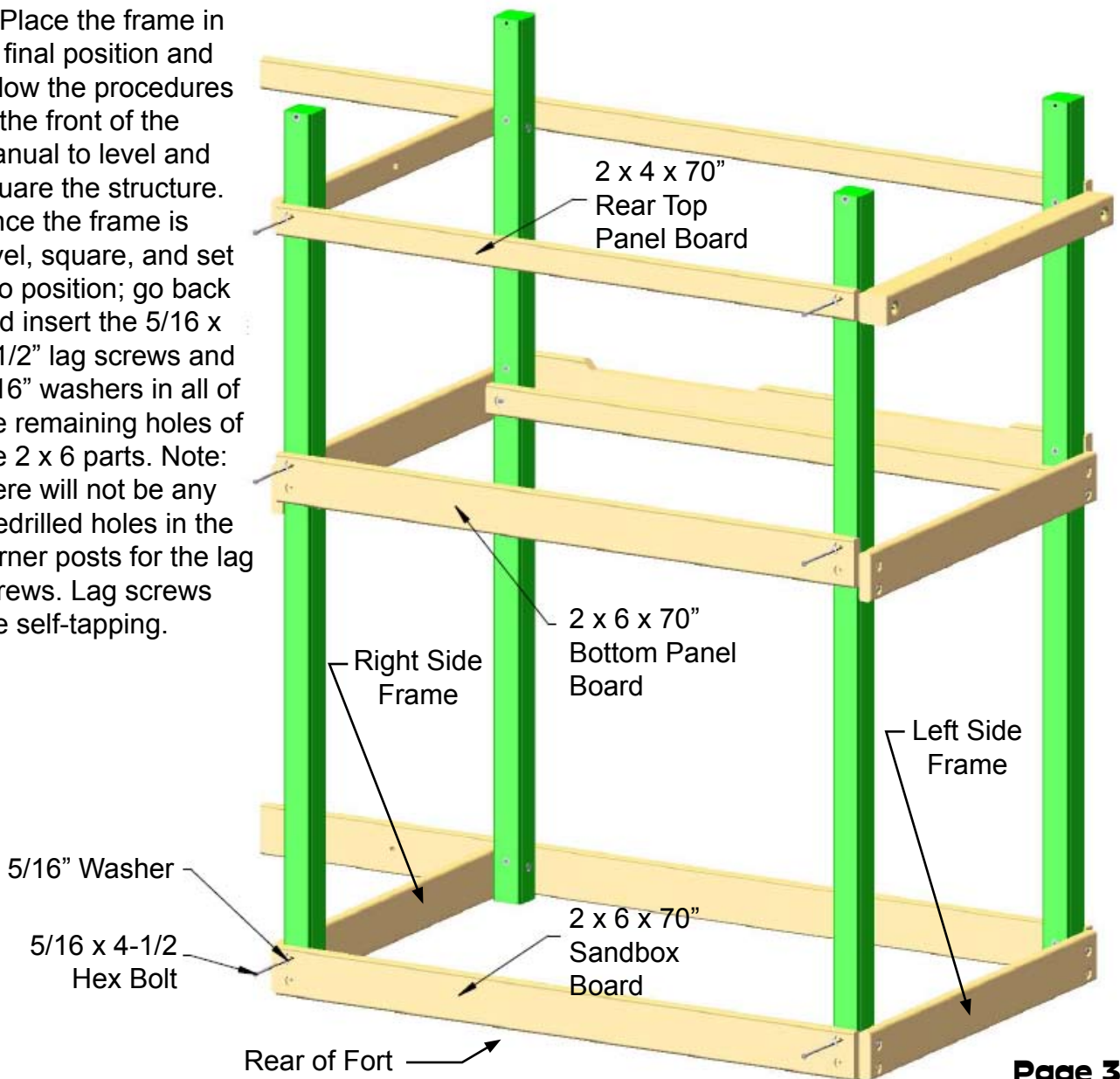

Step 7: Top & Bottom Panel Boards

1: Place the 2 x 4 x 47-1/2" Top Panel Board on top of the 2 x 6 panel board with offset holes up and fasten to the Corner Posts with 5/16 x 3-1/2" lag screws with 5/16" washers.

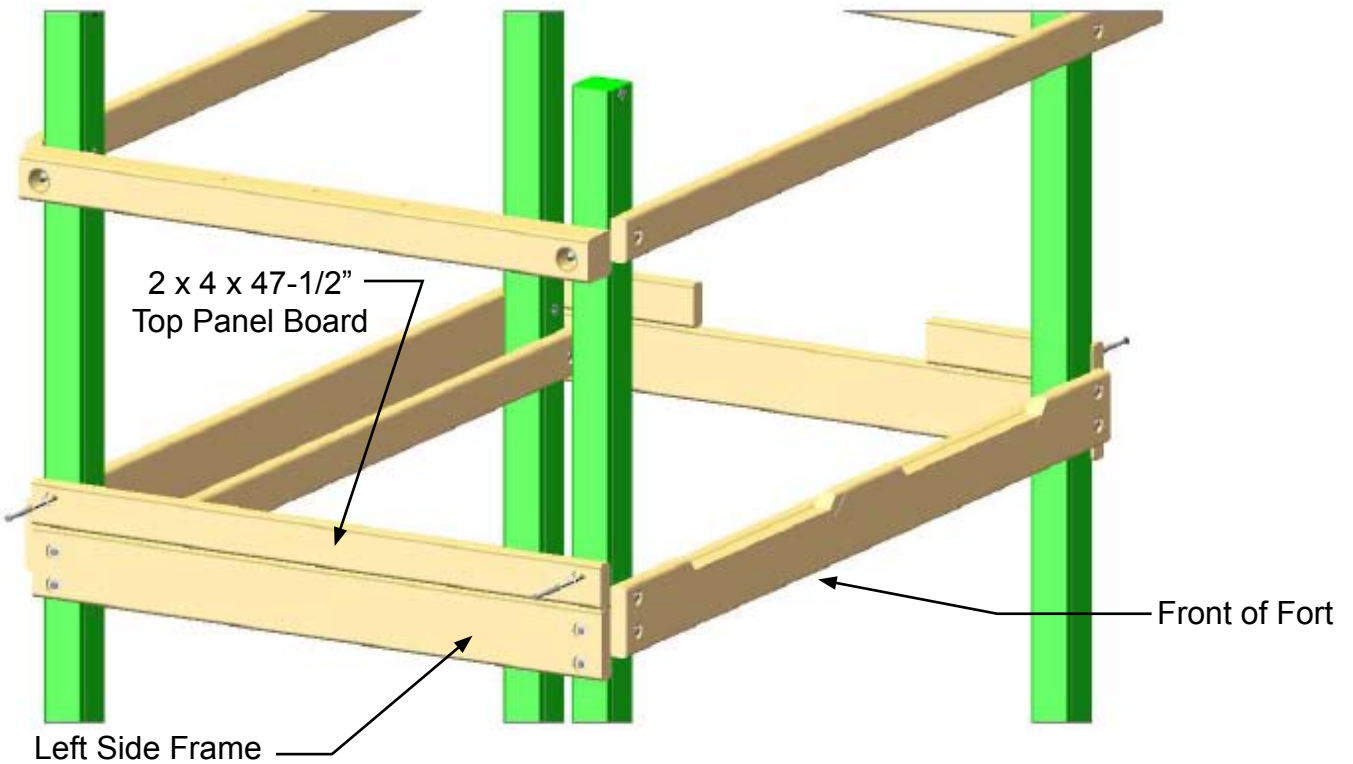

2: Place the 2 x 4 x 14" Bottom Panel Boards on top of the 2 x 6 panel board and fasten to the Corner Posts with 5/16 x 3-1/2" lag screws with 5/16" washers.

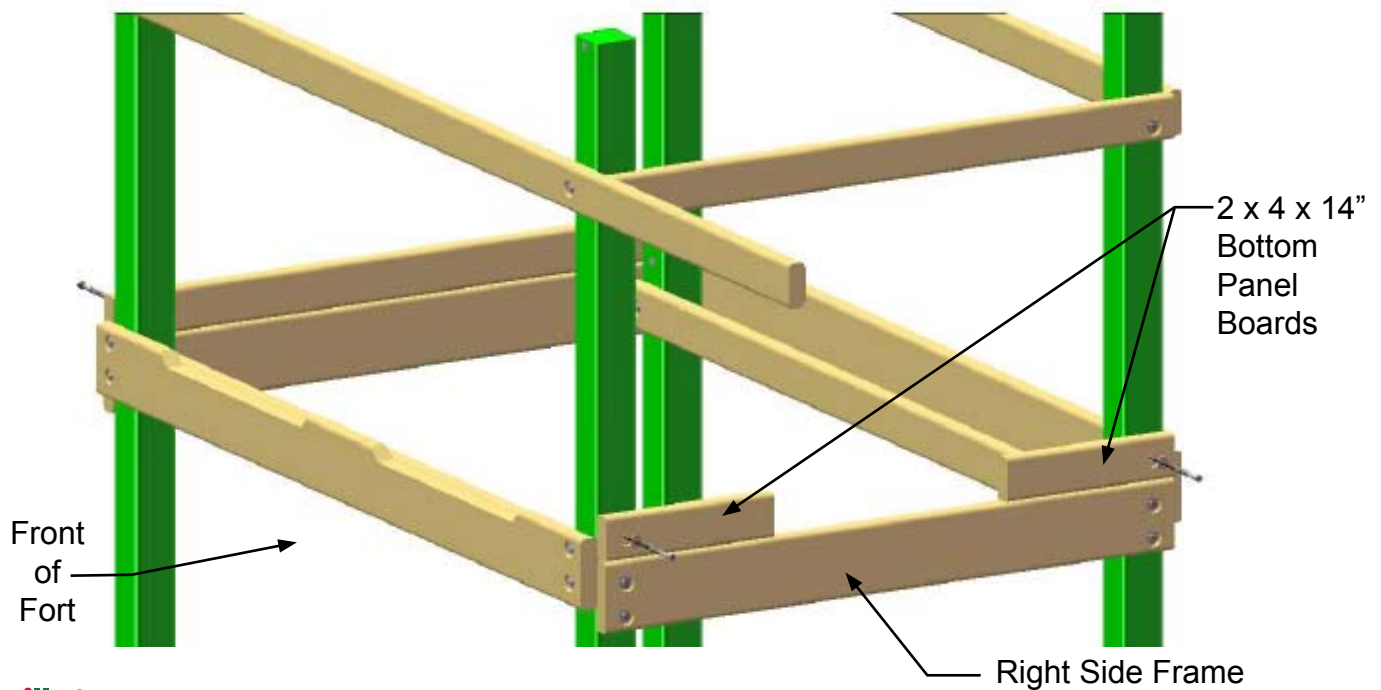

Step 8: Deck Spacers

The following step is recommended to prevent possible splits in the wood.

1: Pre-drill the ends of the Deck Spacers to prevent installation damage. Pre-drill both ends with a 1/8" drill bit at the dimensions shown below. The hole at 20-1/8" is the center of the board and only needs to be drilled once. This hole is to attach the Center Deck Support in Step 9.

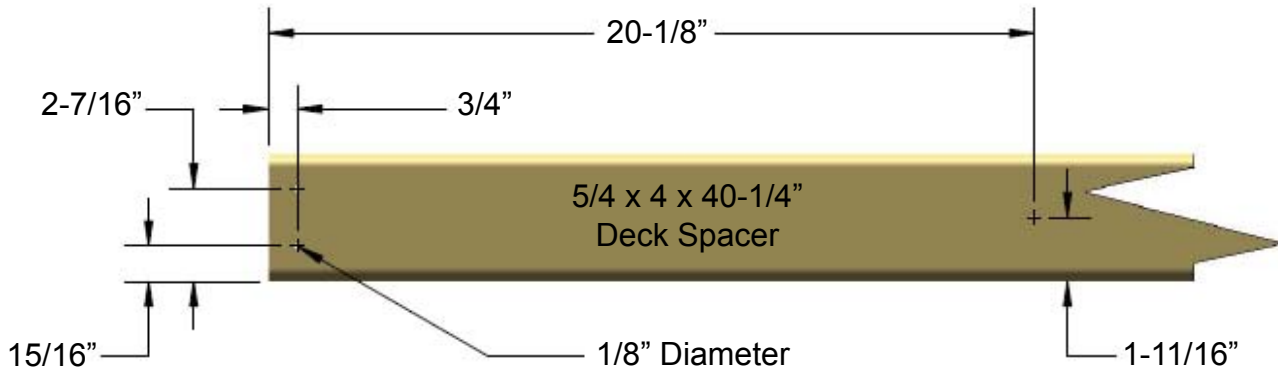

2: Start with the 5/4 x 4 x 40-1/4" Deck Spacer at one end of the fort. Center the board between the Corner Posts and attach it with 2" wood screws through the predrilled holes and into the Deck Support below. Note: the top of the screw head should be flush to the top of the Deck Spacer. Attach other Deck Spacer on other side of the fort.

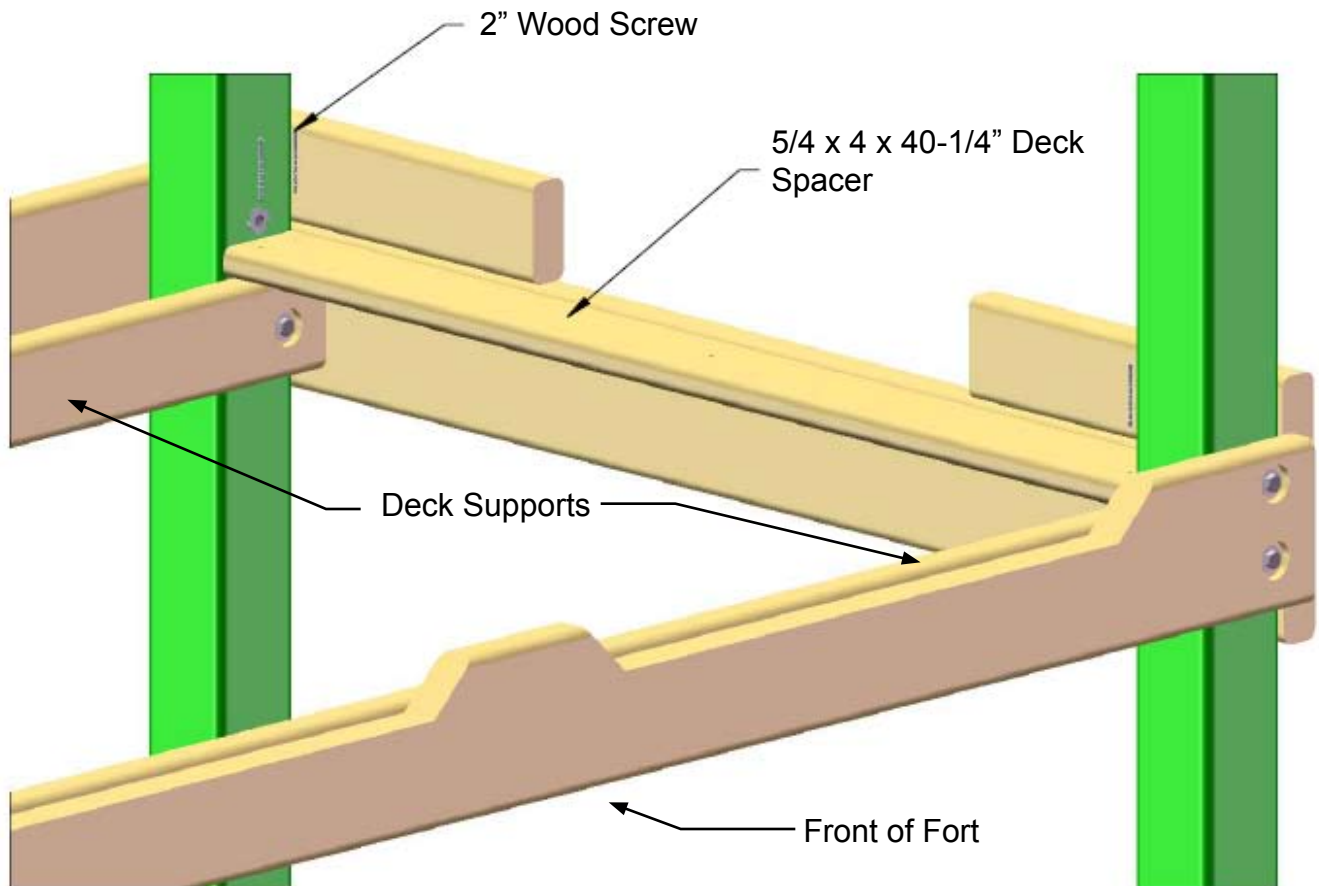

Step 9: Center Deck Support

- 1: Find the 2 x 4 x 70" Center Deck Support without holes.
- 2: Place the Center Deck Support underneath the Deck Spacers (use the hole on center of Deck spacer as a guide) and make a mark on the outside of the Bottom Panel Board(s) to represent a center line.
- 3: Use 2" wood screws to attach the Deck Spacers to the Center Deck Support.
- 4: Now use the center line you drew in substep 2 as your guide to put the 2-1/2" screws in place. Using two 2-1/2" wood screws, attach the 2 x 4 x 70" Center Deck Support through the outside of the Bottom Panel Board, and into the end of the Center Deck Support. Repeat this sub-step on the opposite side of the fort.

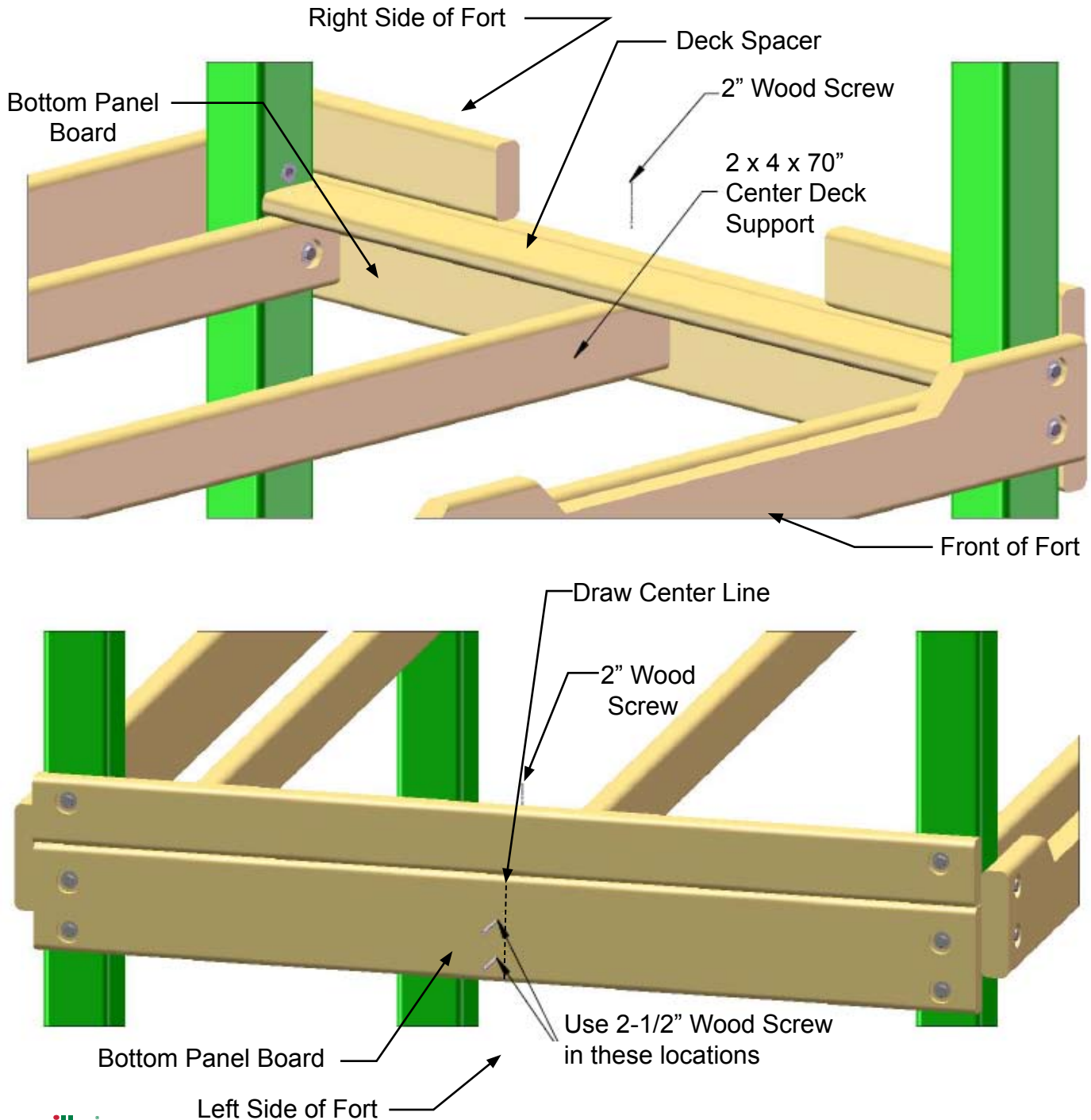

Step 10: Deck Boards

The following step is recommended to prevent possible splits in the wood.

1: Pre-drill the ends of the Deck Boards to prevent installation damage. Pre-drill both ends with a 1/8" drill bit at the dimensions shown below. The hole at 23-11/16" only needs to be drilled once.

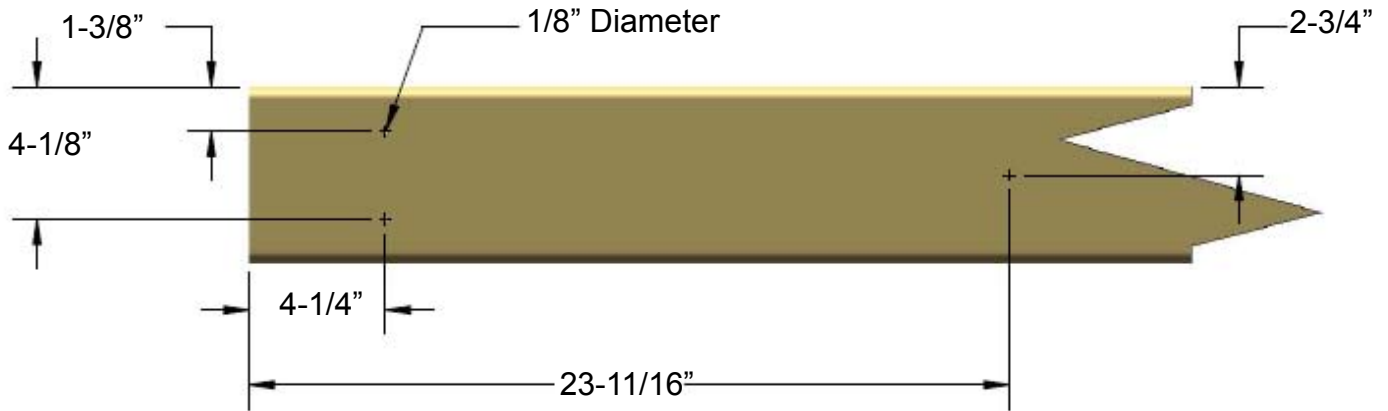

2: Start with a 5/4 x 6 x 47-3/8" Deck Board at one end of the fort. Center the board between the Front Face Board and the rear Bottom Panel Board and attach it with 2" wood screws through the predrilled holes and into the Deck Support below. Leave a uniform (approximately 1/4") space between the Deck Boards. Note: the top of each screw head should be flush to the top of the Deck Boards.

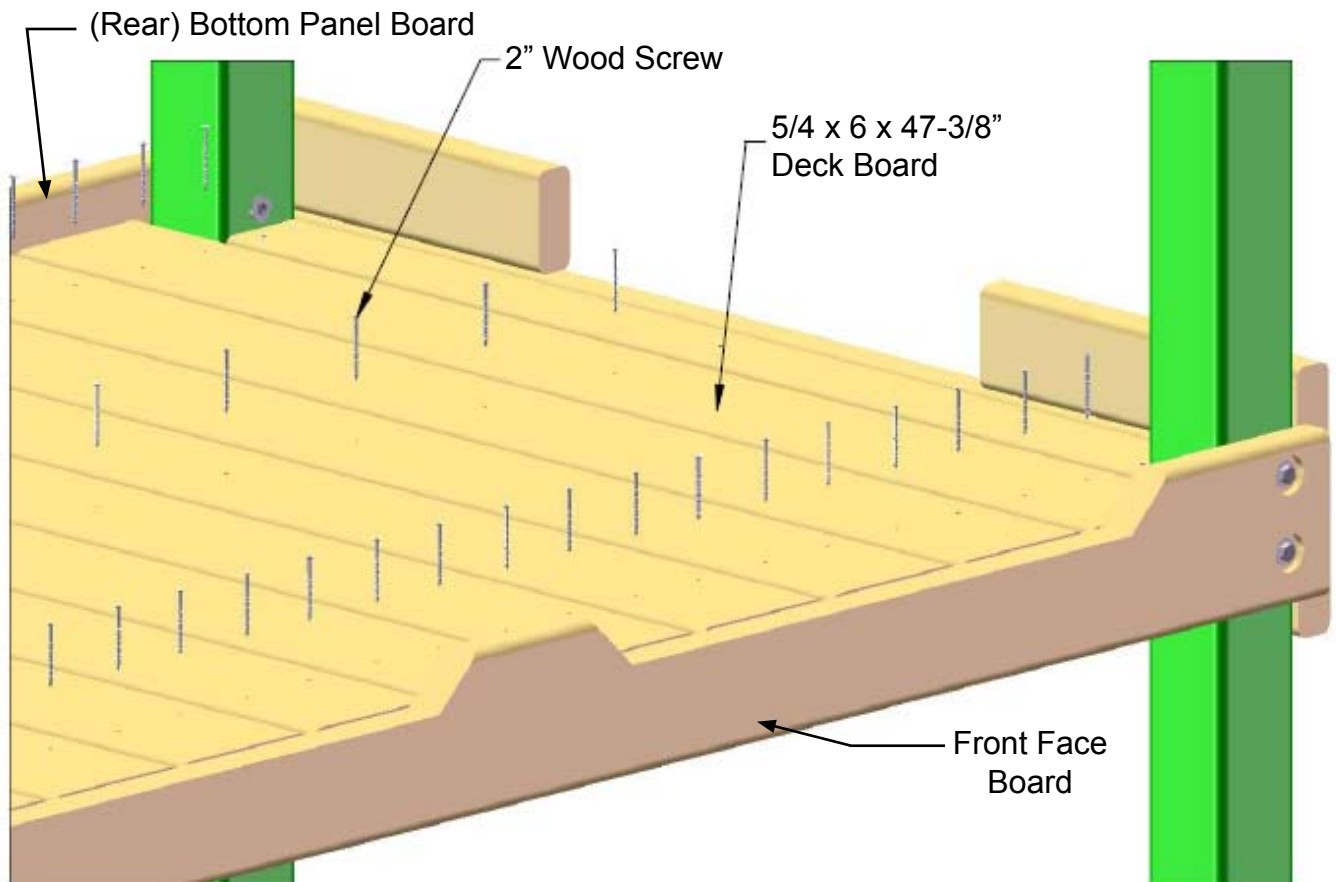

Step 11: Rock Wall

- 1: Find two 2 x 4 x 66" Rock Wall Sides.
- 2: Position the Rock Wall Sides so that the holes in the boards are both facing the same way.
- 3: Insert t-nuts into the inside of the Rock Wall Sides and set with a hammer.

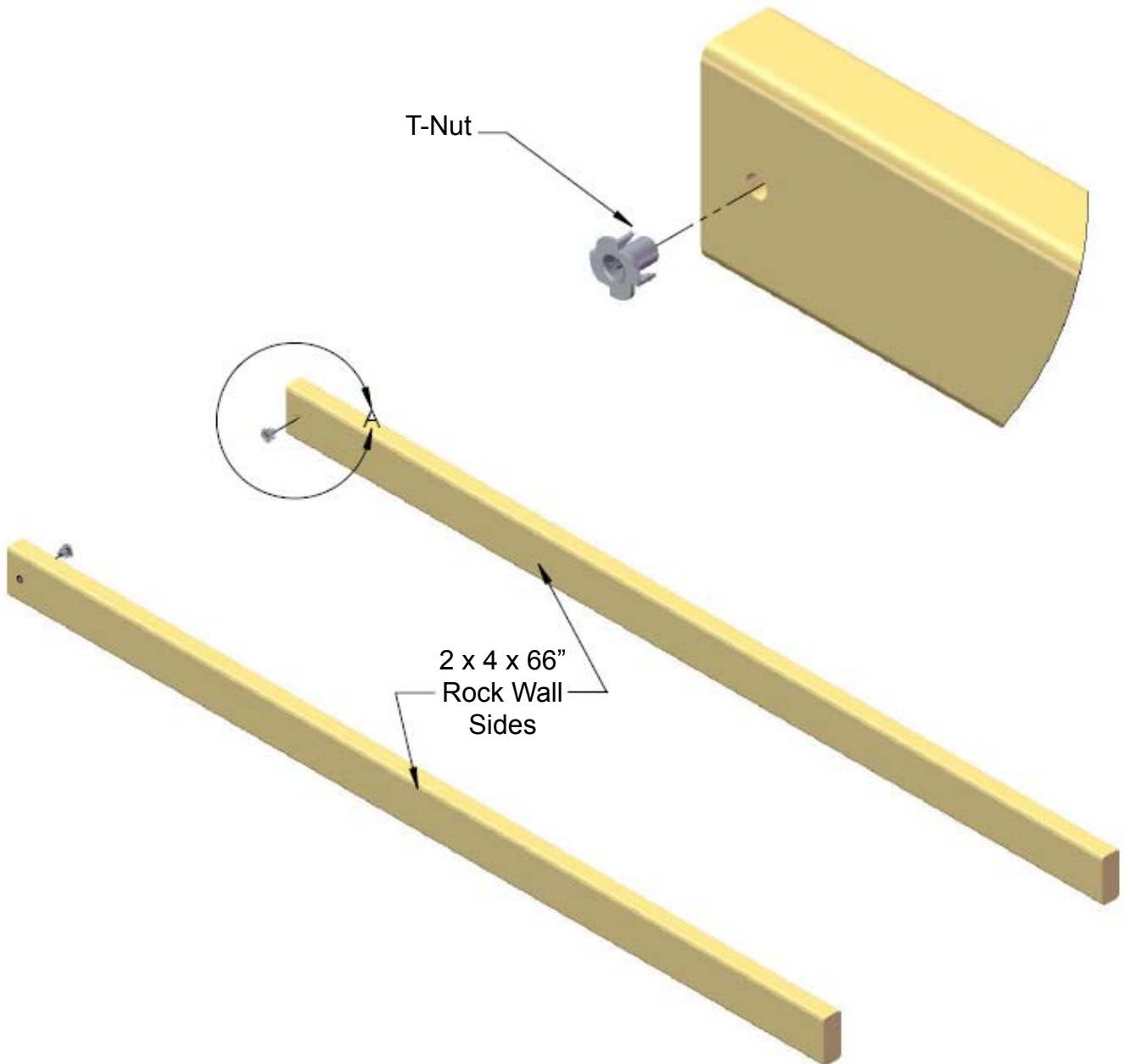

Step 12: Rock Wall

- 1: Find eleven 5/4 x 6 x 23-7/8" Rock Wall Boards, and one 5/4 x 6 x 23-7/8" Bottom Rock Wall Board (1 Hole).
- 2: Starting from the top, place one Rock Wall Board on top of the Rock Wall Sides, flush to the top of the Rock Wall Sides, and attach with two 2" wood screws in each side.
- 3: Continue down the Rock Wall with the remaining Rock Wall Boards, fastening each board with two 2" wood screws on each end.
- 4: The final board will be the Bottom Rock Wall Board with one hole. Attach with two 2" wood screws per side.
- 5: In some cases, there will be excess length on the Rock Wall Sides. This is due to milling variations, and is also used to help level the Rock Wall Sides on uneven ground.
- 6: Rock Wall Sides may not be even with the Bottom Rock Wall Board due to milling variations and wood shrinkage.

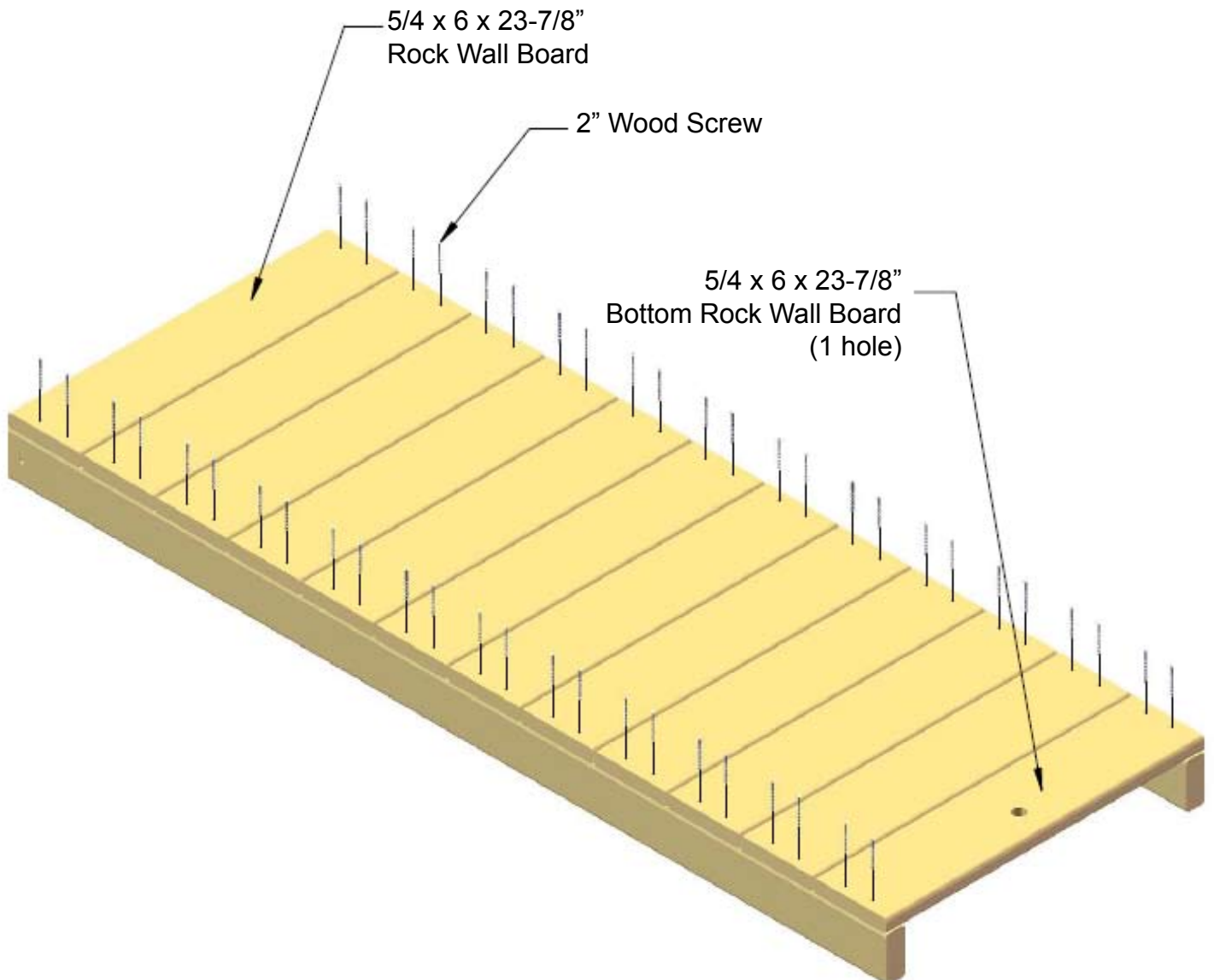

Step 13: Rock Wall

- 1: Fasten the 90° Green Brackets to the Rock Wall Sides with 5/16 x 1-1/2" hex bolts and 5/16" washers.
- 2: Do not fully tighten the hex bolts into the t-nuts at this time.

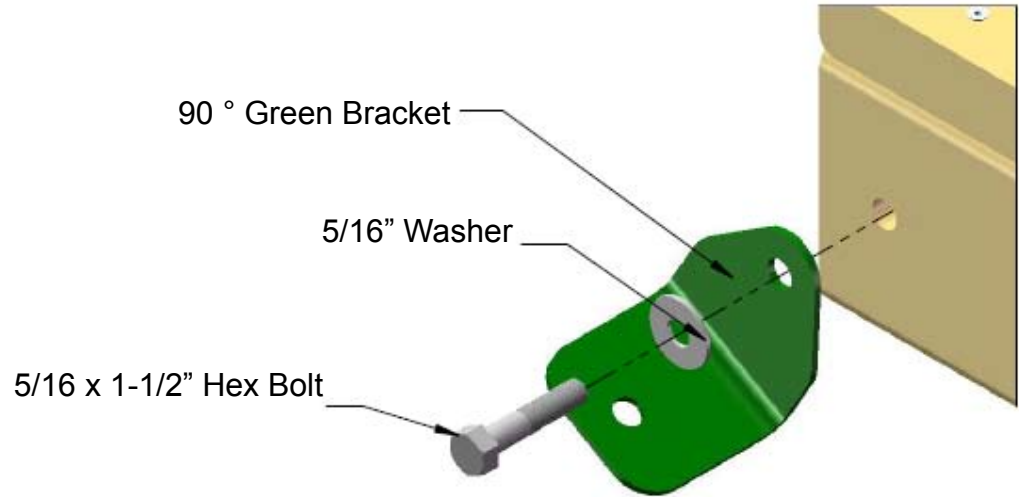

Detail A

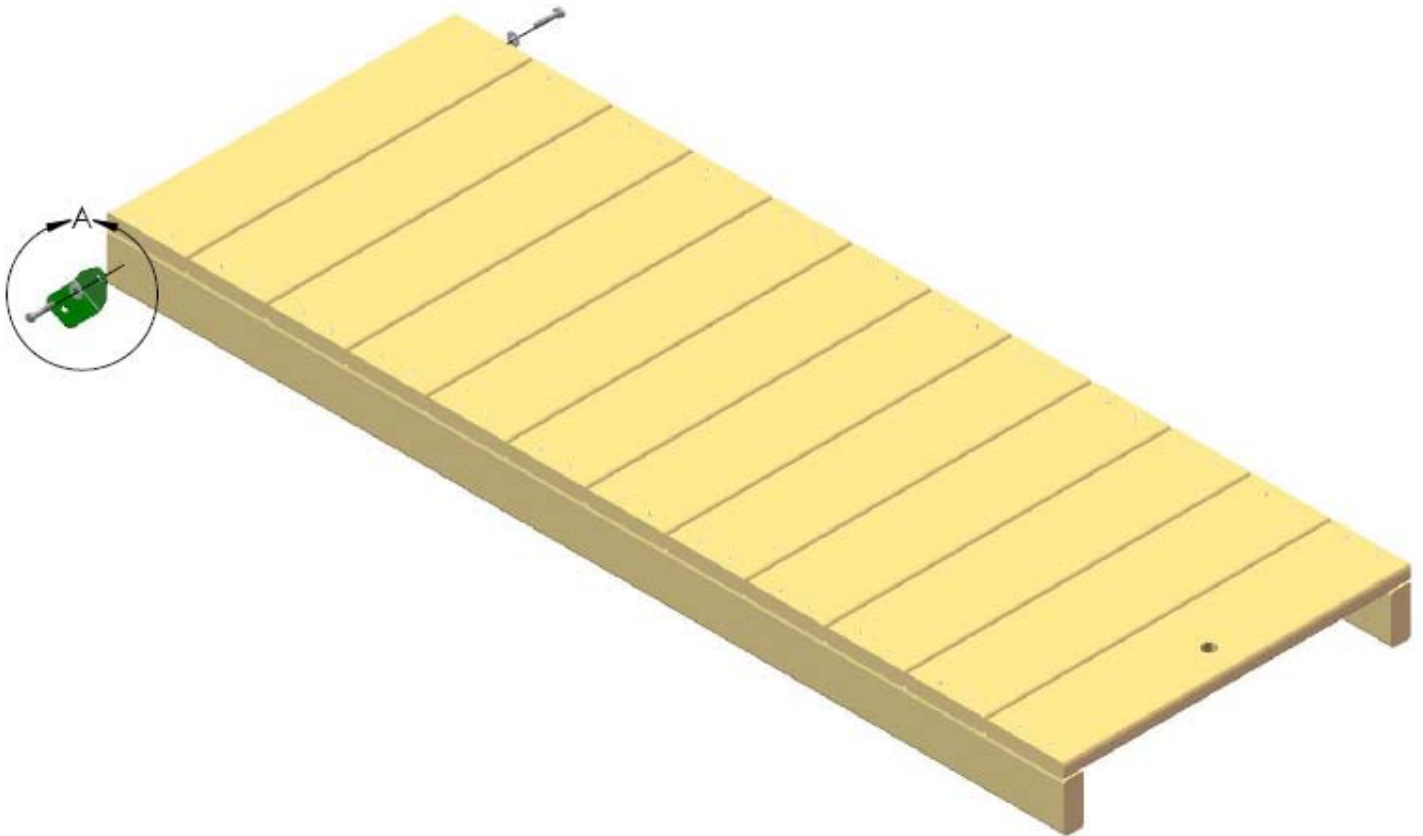

Step 14: Rock Wall

1: Find ten Climbing Rocks and thirty 1-1/4" pan head screws and washers.

2: Mount the Climbing Rocks in a staggered manner on the Rock Wall Boards. Three pan head screws with washers will secure each Climbing Rock to the wall.

Note: the image shown below is a generic arrangement of the Climbing Rocks on the Rock wall. Your actual configuration may be different that what you see below. Climbing Rocks can be arranged in any pattern as long as they will allow proper access to the fort. Be creative!

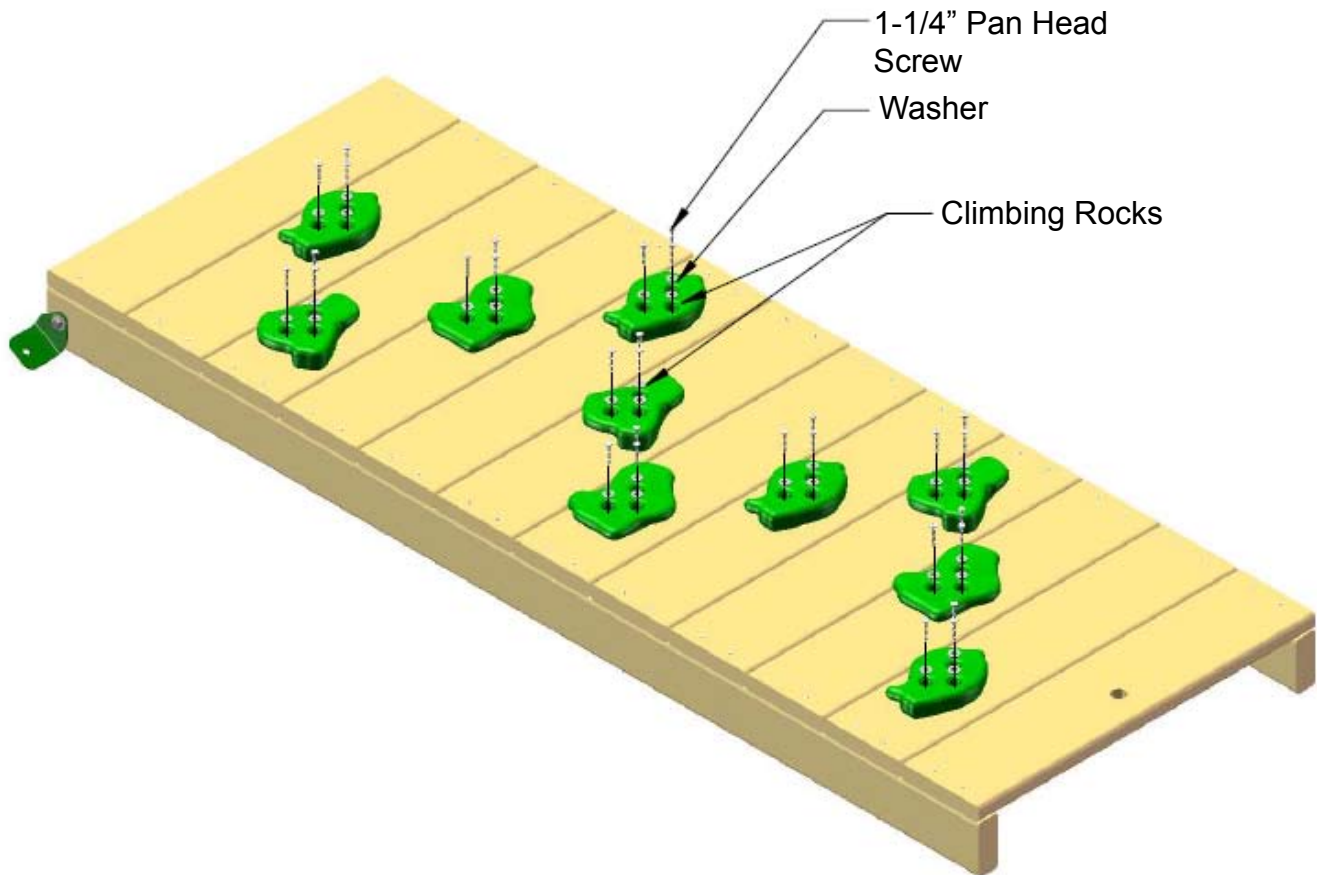

3: Place the 5/4 x 2-5/8 x 23-7/8" Rock Wall Top Cap on top of the Rock Wall Sides. Fasten the Rock Wall Top Cap to the Rock Wall Sides with 2" wood screws.



Step 15: Attaching the Rock Wall

- 1: Place the Rock Wall into position on the Right Side of the fort as shown below. Using the 90° Green Brackets as a template; drill a 3/8" hole through the Bottom Panel Board.
- 2: Go underneath the deck to insert a t-nut into the backside of the 3/8" holes in the Bottom Panel Board.
- 3: Attach the Rock Wall with 5/16 x 1-1/2" hex bolts and 5/16" washers.
- 4: When the brackets are secure, and the Rock Wall is in its final position; tighten the 5/16 x 1-1/2" hex bolts on the Rock Wall Sides.

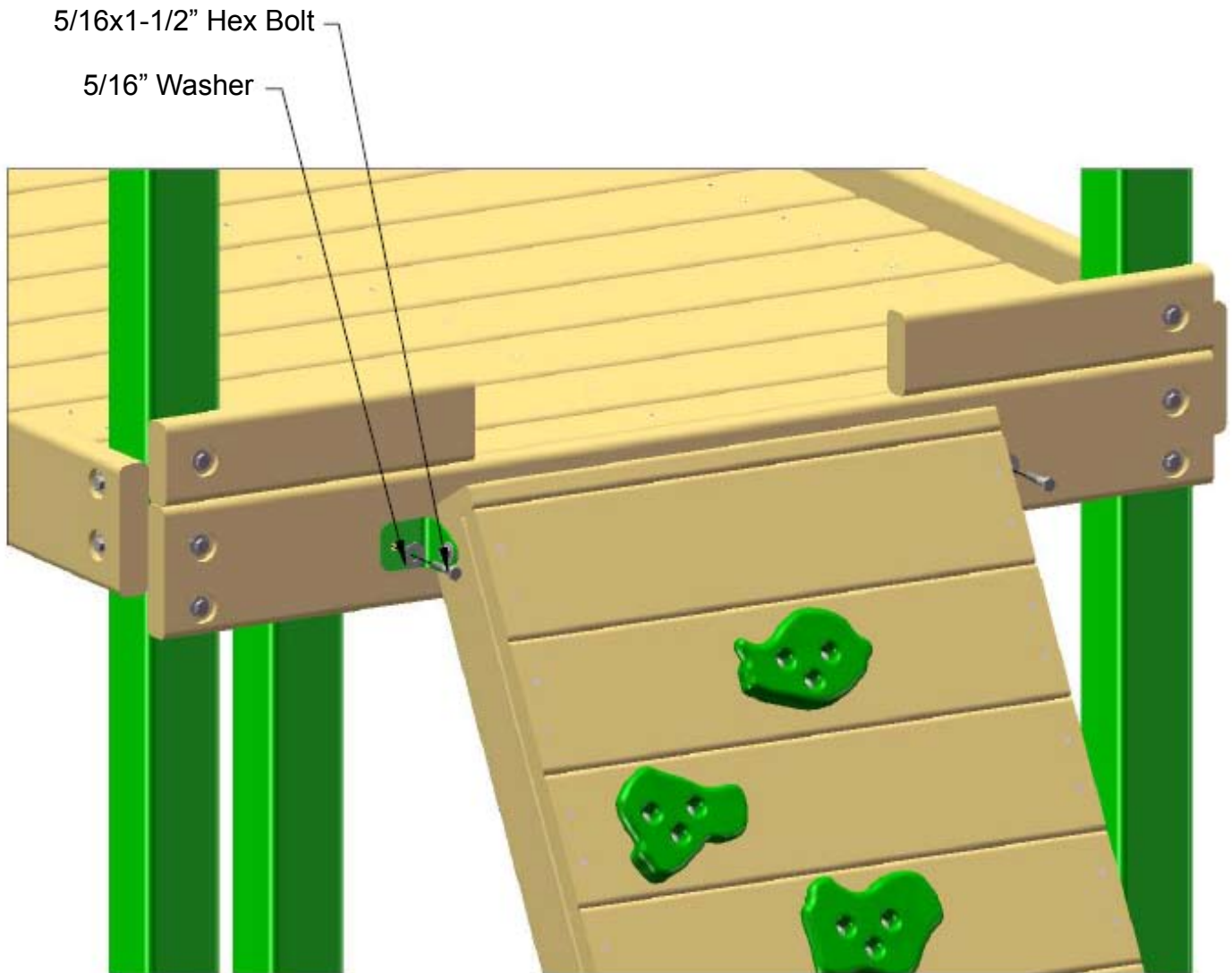

Right Side of Fort

Step 16: Climbing Ramp

- 1: Lay out the 2 x 4 x 96" Ramp Side Boards making sure the angled end faces align with one another. The short face on the angled end should face down.
- 2: **FIRST** place one 2 x 4 x 18-3/4" Ramp Support Board at the square end of the 2 x 4 x 96" Ramp Side Boards. Offset the board 1" from the end. Fasten the Ramp Support Board to the Ramp Side Boards with two 2-1/2" wood screws per side.
- 3: **SECOND** place one 2 x 4 x 18-3/4" Ramp Support Board at the angled end of the 2 x 4 x 96" Ramp Side Boards. Offset the board 1" from the edge. Fasten the Ramp Support Board to the Ramp Side Boards with two 2-1/2" wood screws per side.
- 4: Place the remaining 2 x 4 x 18-3/4" Ramp Support Board across the Ramp Side Boards in the middle, and fasten with two 2-1/2" wood screws per side.

NOTE: Climbing Ramp to be installed instead of ladder on this model. The Ladder parts are included in the package but are NOT used.

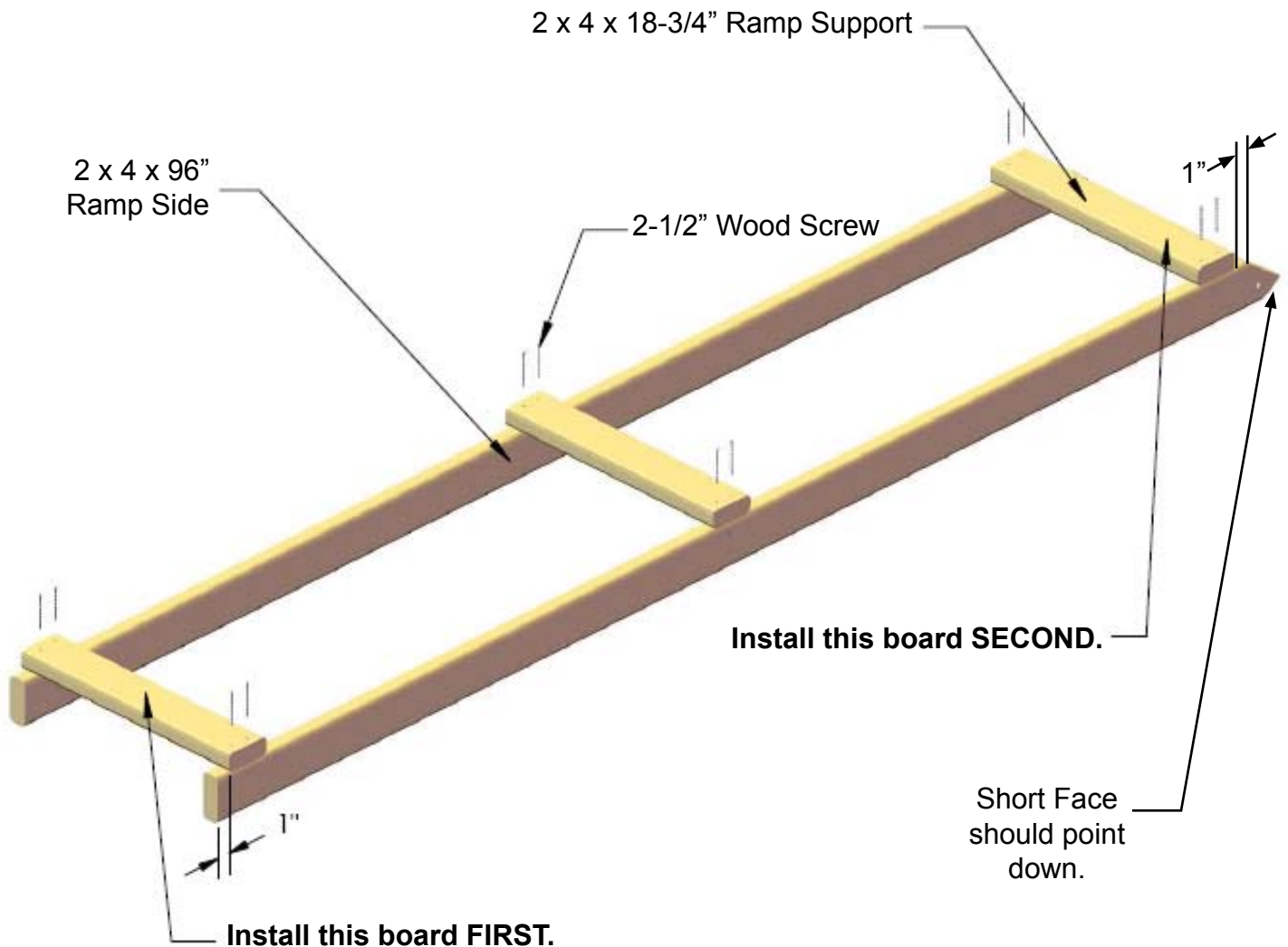

Step 17: Climbing Ramp

1: FLIP the Climbing Ramp Frame over. Place one 2 x 6 x 94" Floor Board against each of the Ramp Side Boards. Fasten the Floor Boards to the Ramp Support Boards with two 2-1/2" wood screws per support.

2: Place the 2 x 4 x 94" Floor Board on the center of the ramp. The hole at 7" should be towards the angled end of the ramp. Fasten the Floor Board to the Ramp Support Boards with two 2-1/2" wood screws per Support.

3: Place one 2-1/2" wood screw through the Ramp Side Boards, above each of the Ramp Supports into the Floor Boards.

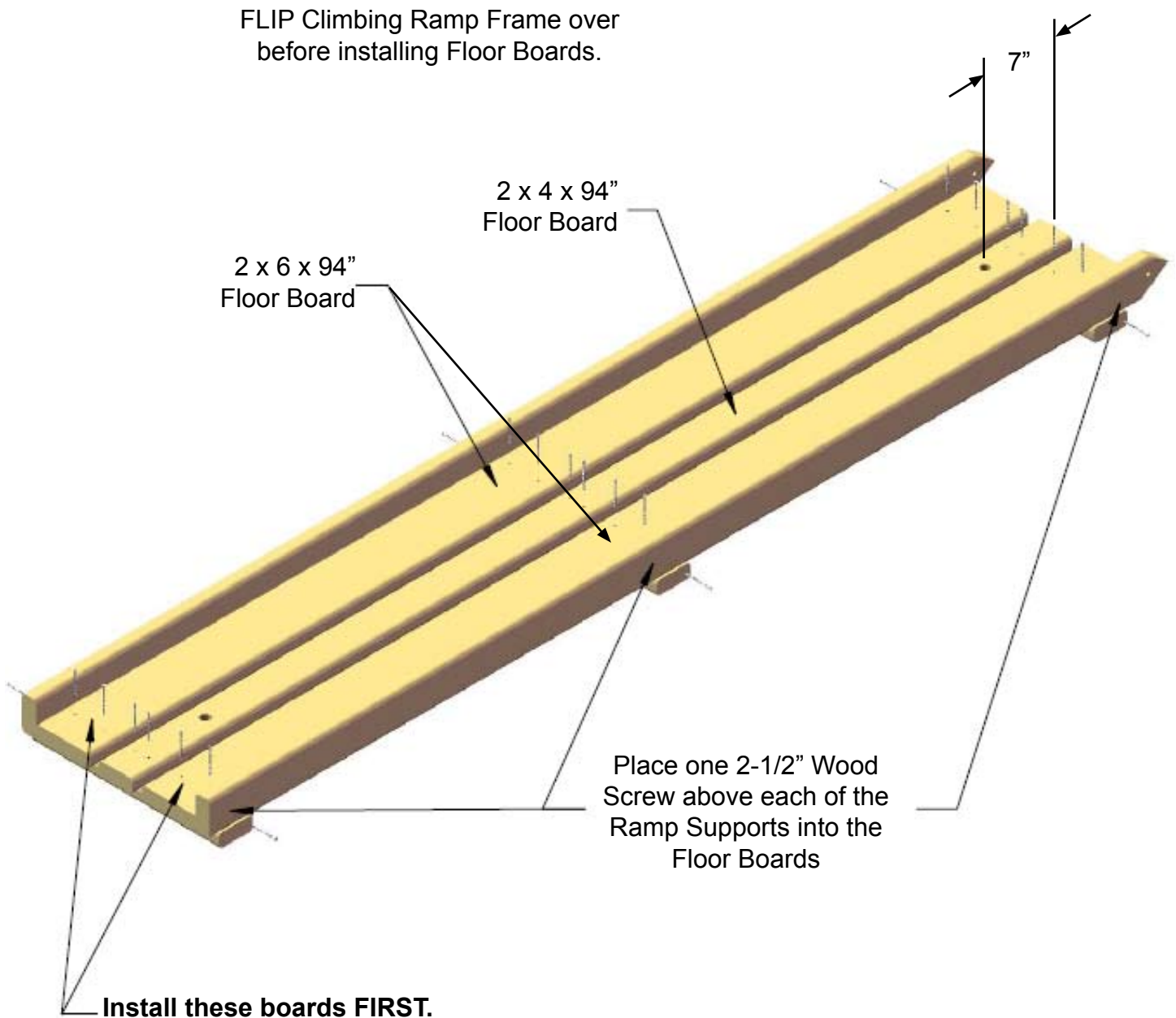

Step 18: Climbing Ramp

- 1: Attach the 2 x 2 x 16" Floor Support Boards to the Floor Boards with 2-1/2" wood screws. (See detail view below.)
- 2: Place t-nuts on the inside of the holes in the Ramp Side Boards. Set the t-nuts with a hammer flush/near flush with the Ramp Sides.
- 3: Fasten the 90° Green Brackets to the Ramp Sides with 5/16 x 1-1/2" hex bolts and 5/16" washers.

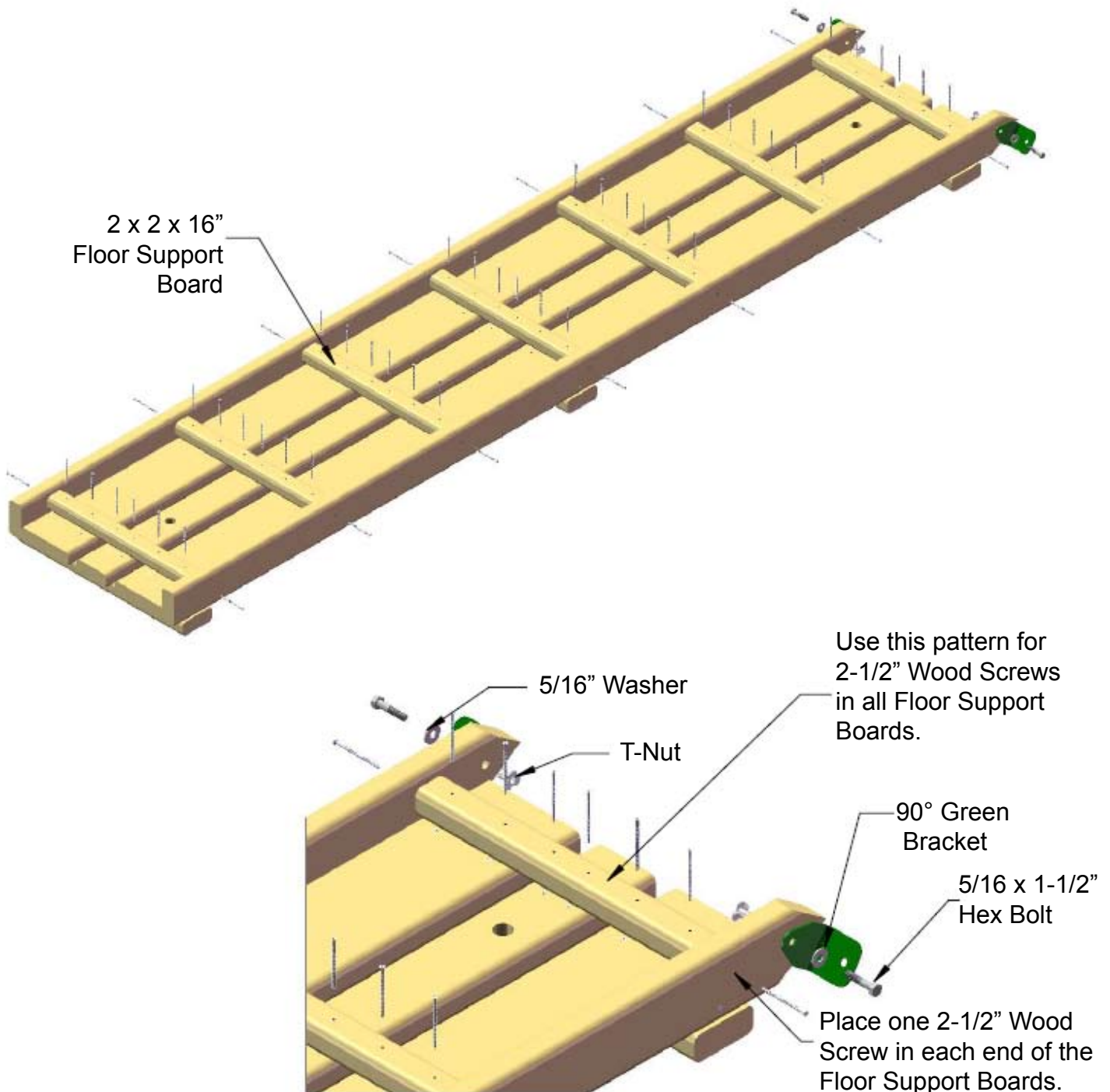

Step 19: Climbing Ramp to Fort

- 1: Place the Climbing Ramp into position on the fort as shown below. Using the 90° Green Brackets as a template drill a 3/8" hole through the Front Face Board.
- 2: Go underneath the deck to insert a t-nut into the backside of the 3/8" holes in the Front Face Board.
- 3: Attach the Climbing Ramp with 5/16 x 1-1/2" hex bolts and 5/16" washers.
- 4: When the 90° Green Brackets are secure, and the Climbing Ramp is in its final position; tighten the 5/16 x 1-1/2" hex bolts on the Ramp Sides.

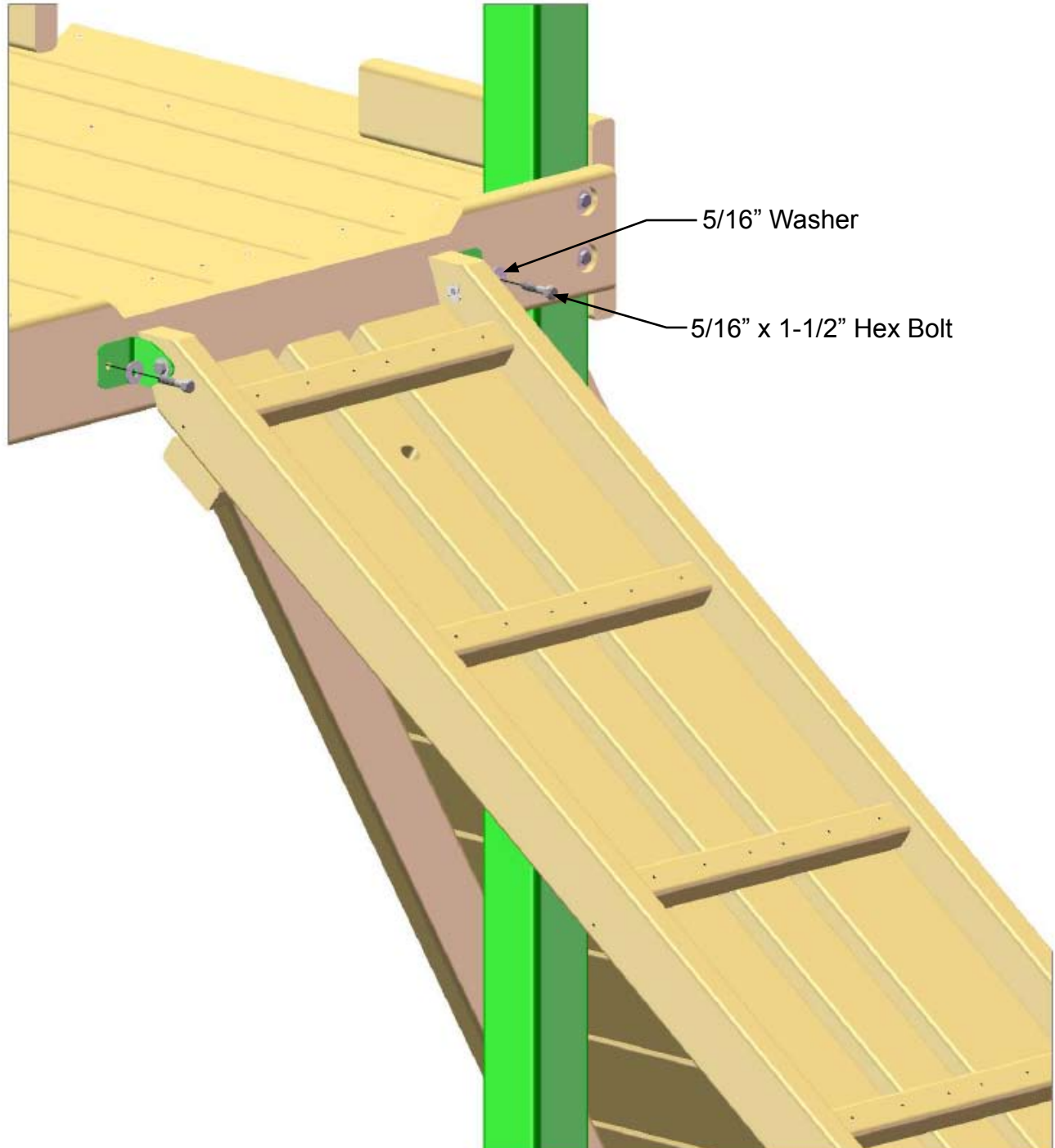

Step 20: Panel Slats

- 1: Find twenty-seven $5/4 \times 2-5/8 \times 28-1/2$ " Panel Slats.
 - 2: Pre-drill the Panel Slats 1" from each end on center with a $1/8$ " drill bit.
 - 3: Install the Panel Slats at equal spacing. See detail below for measurements.
 - 4: Attach the Panel Slats to the fort with 2" wood screws in the pre-drilled holes.
- Note: 2 Panel Slats will be left over after this step. This is normal.

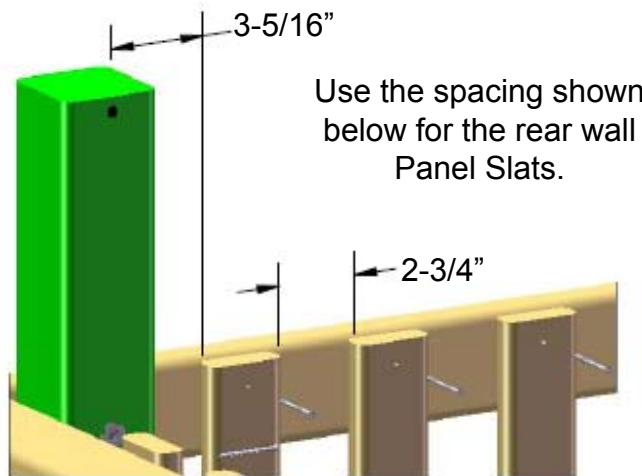
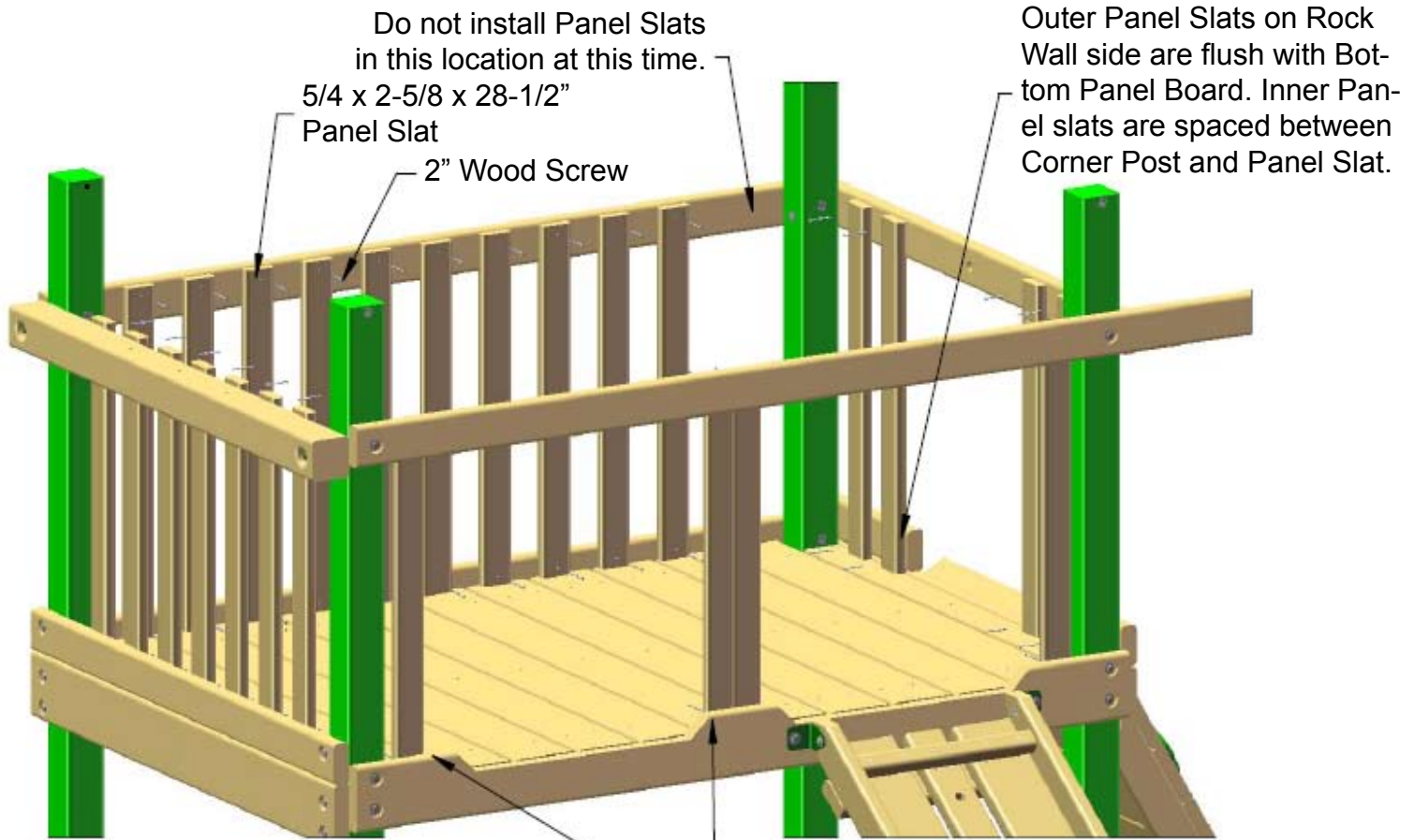

Rear Panel Slat Spacing

Front Panel Slats are installed flush to the notch on the Front Face Board.

Install Panel Slat at the center of the Swing Beam Support first and use the spacing shown below.

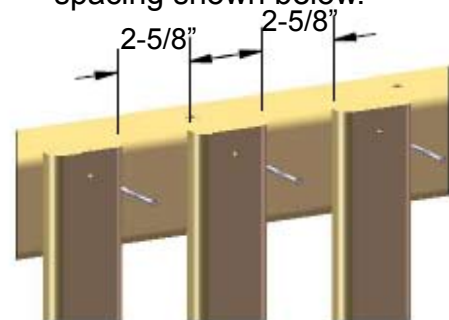

Swing Beam Side Panel Spacing

Step 21: Swing Beam Plate

- 1: Place the Swing Beam Plate on top of the Swing Beam Support, lining up the pilot holes.
- 2: Fasten the Swing Beam Plate to the Swing Beam Support using 3-1/2" carriage bolts and 3/8" lock nuts with 3/8" washers from underneath, in the counter-sunk holes of the Swing Beam Support. Use bolt caps to cover any exposed threads.
- 3: Leave the middle hole empty, it will be used later.

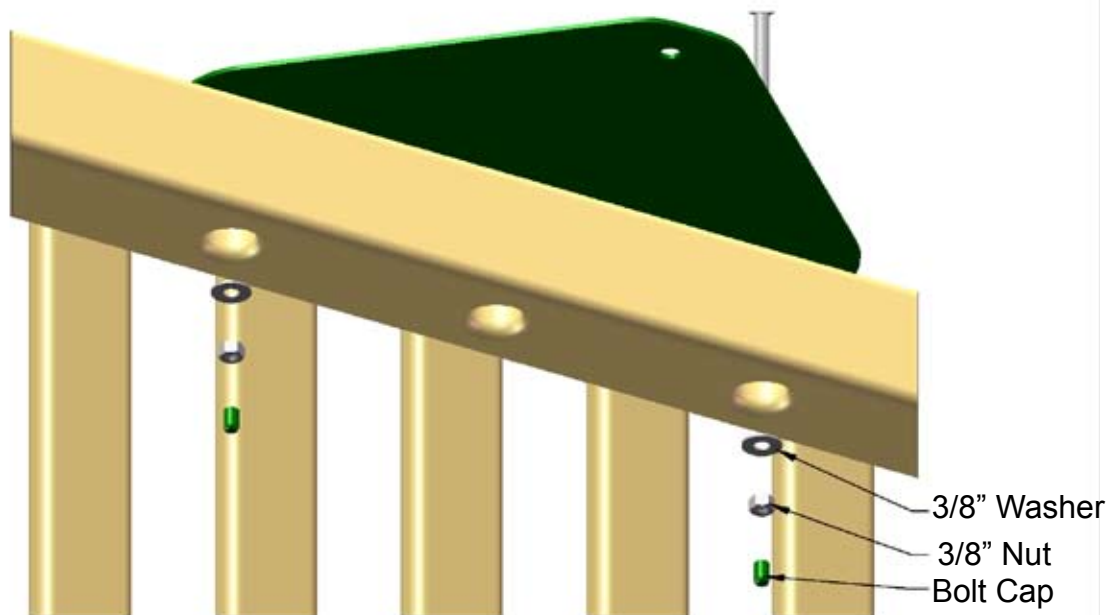
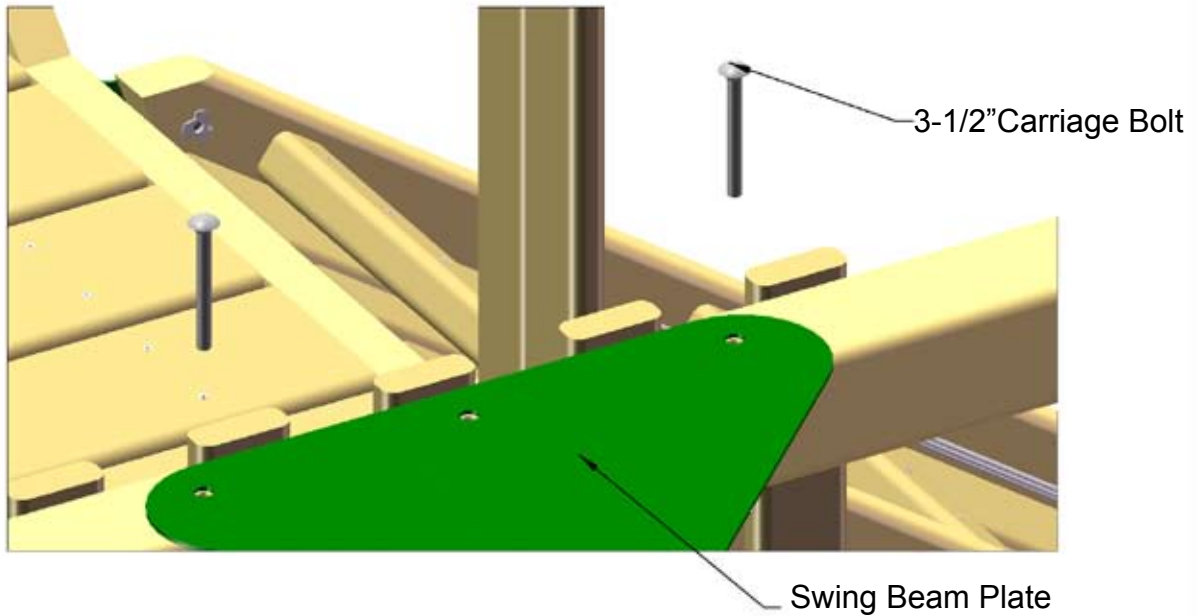

Step 22: Iron Ductiles

- 1: Line up the holes of the Iron Ductile Swing Hangers with the holes in the Swing Beam.
- 2: Fasten each Iron Ductile Swing Hanger to the swing beam using 7" carriage bolts with torque washers, and 3/8" washers with 3/8" lock nuts.
- 3: Place bolt caps over exposed threads.

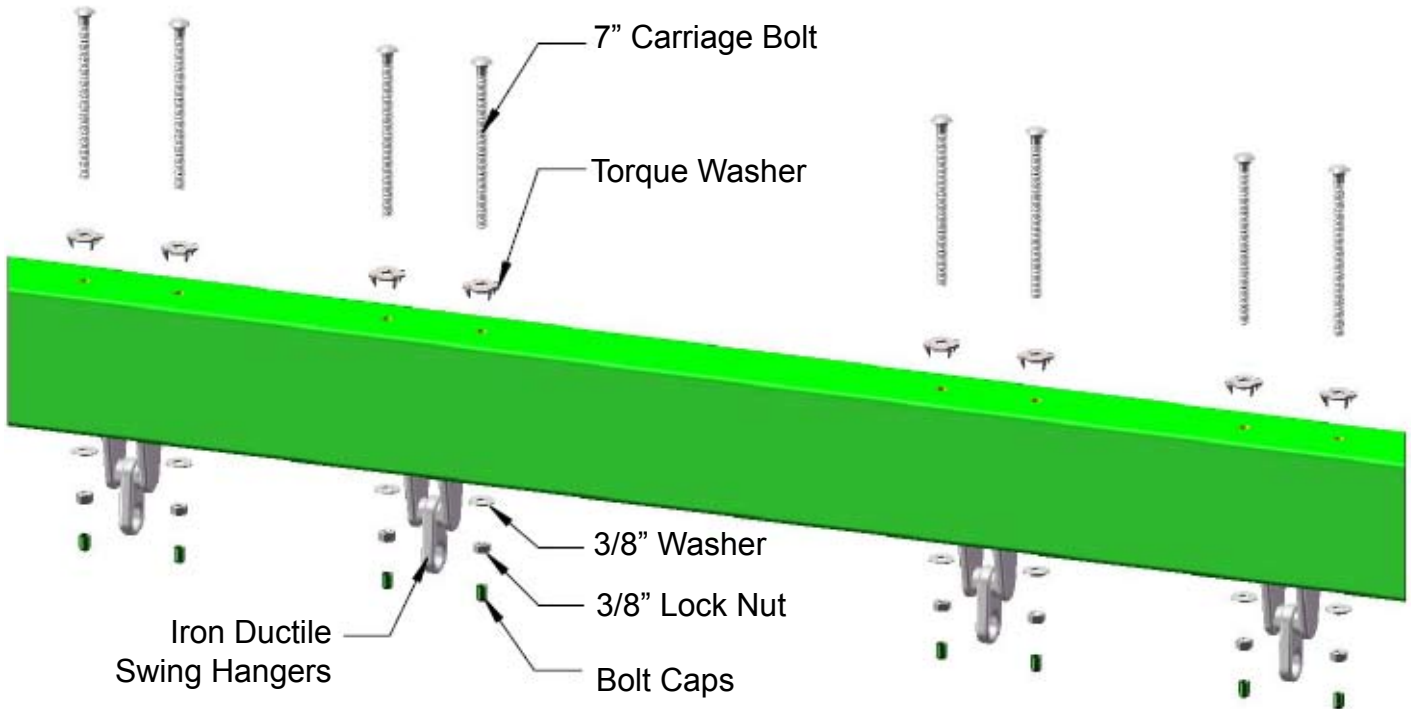

Step 23: Attach Swing Legs to Bracket

- 1: Place the 4 x 4 x 108" Swing Legs flush to the top of the Swing Leg Bracket.
- 2: Fasten the Swing Legs to the Swing Leg Bracket with 3/8 x 3-1/2" lag screws and 3/8" washers.

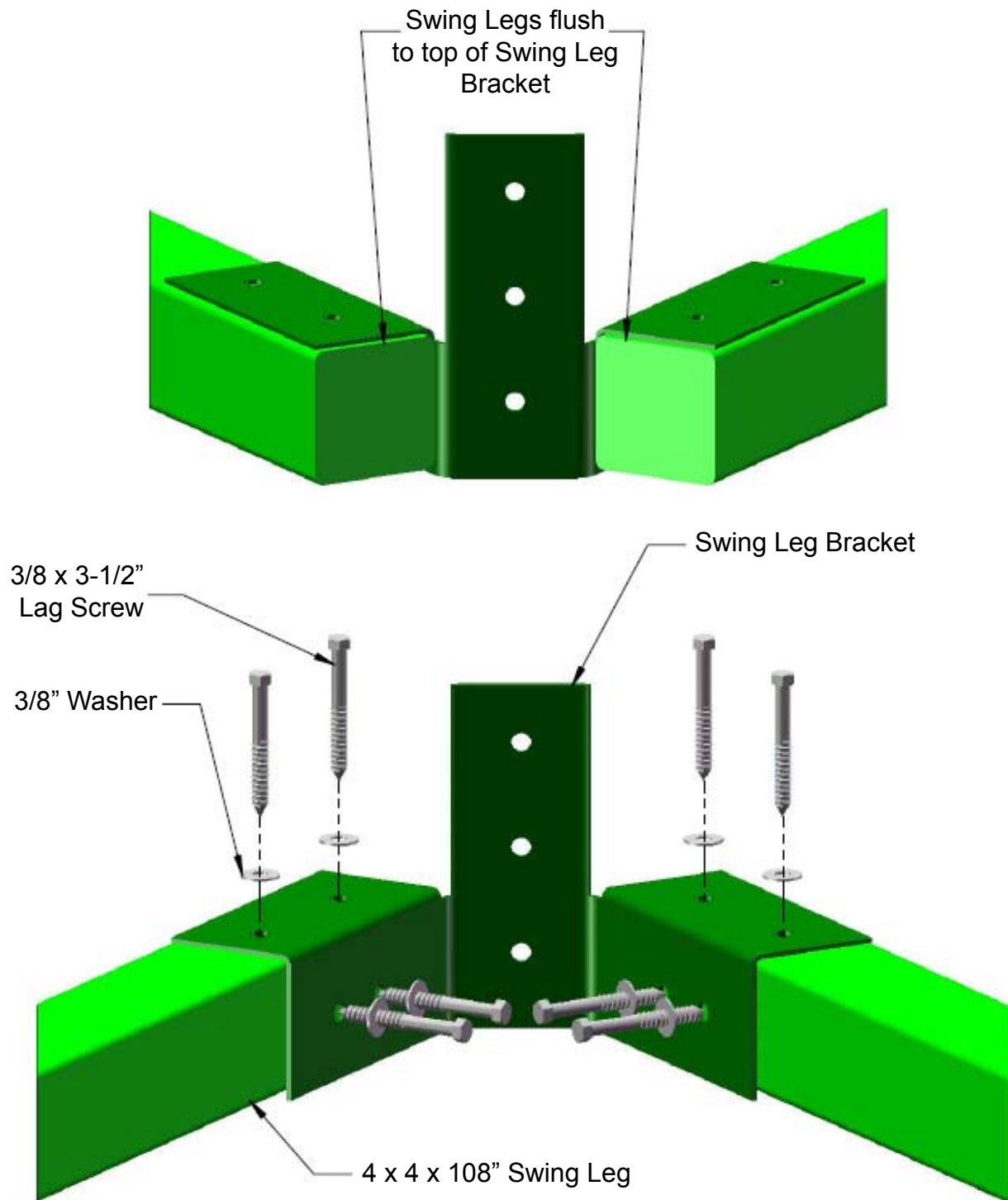

Step 24: Rest Swing Beam on Fort

*Two people are required for this step

1: Lay the Swing Beam across the fort and position the legs underneath the end of the beam.

2: Line up the pre-drilled holes and rest the Swing Beam on top of the Swing Beam Support Plate and Swing Legs. Make sure the Iron Ductiles are facing down.

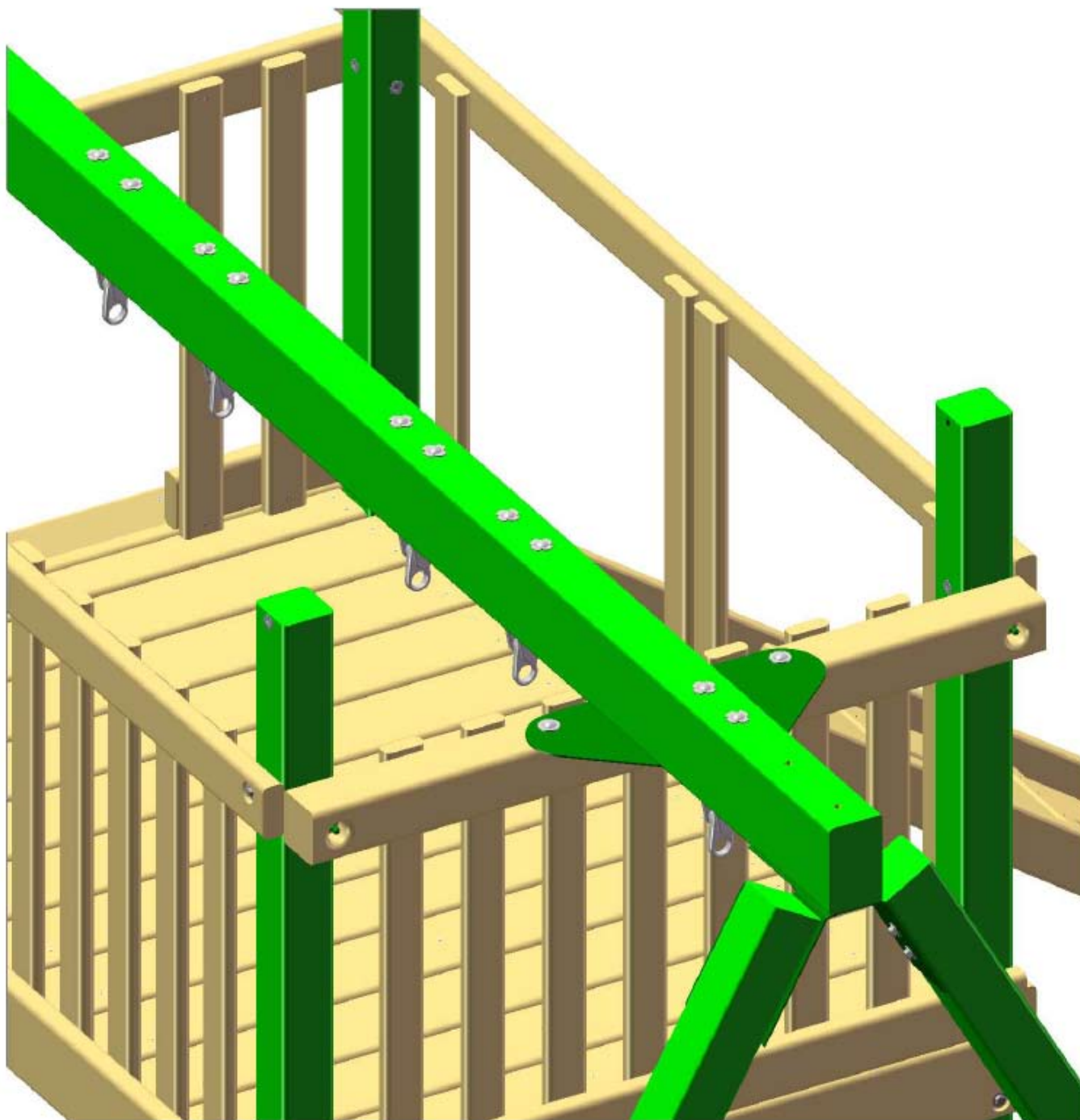

Step 25: Mount Swing Beam to Swing Beam Legs

- 1: Fasten the Swing Beam to the Swing Leg Bracket using 7" carriage bolts with torque washers on top of the Swing Beam, and 3/8" lock nuts with 3/8" washers from underneath.
- 2: Use a 3/8 x 3-1/2" lag screw with 3/8" washer for the hole in the center of the Swing Leg Bracket.
- 3: Place a bolt cap over any exposed threads.

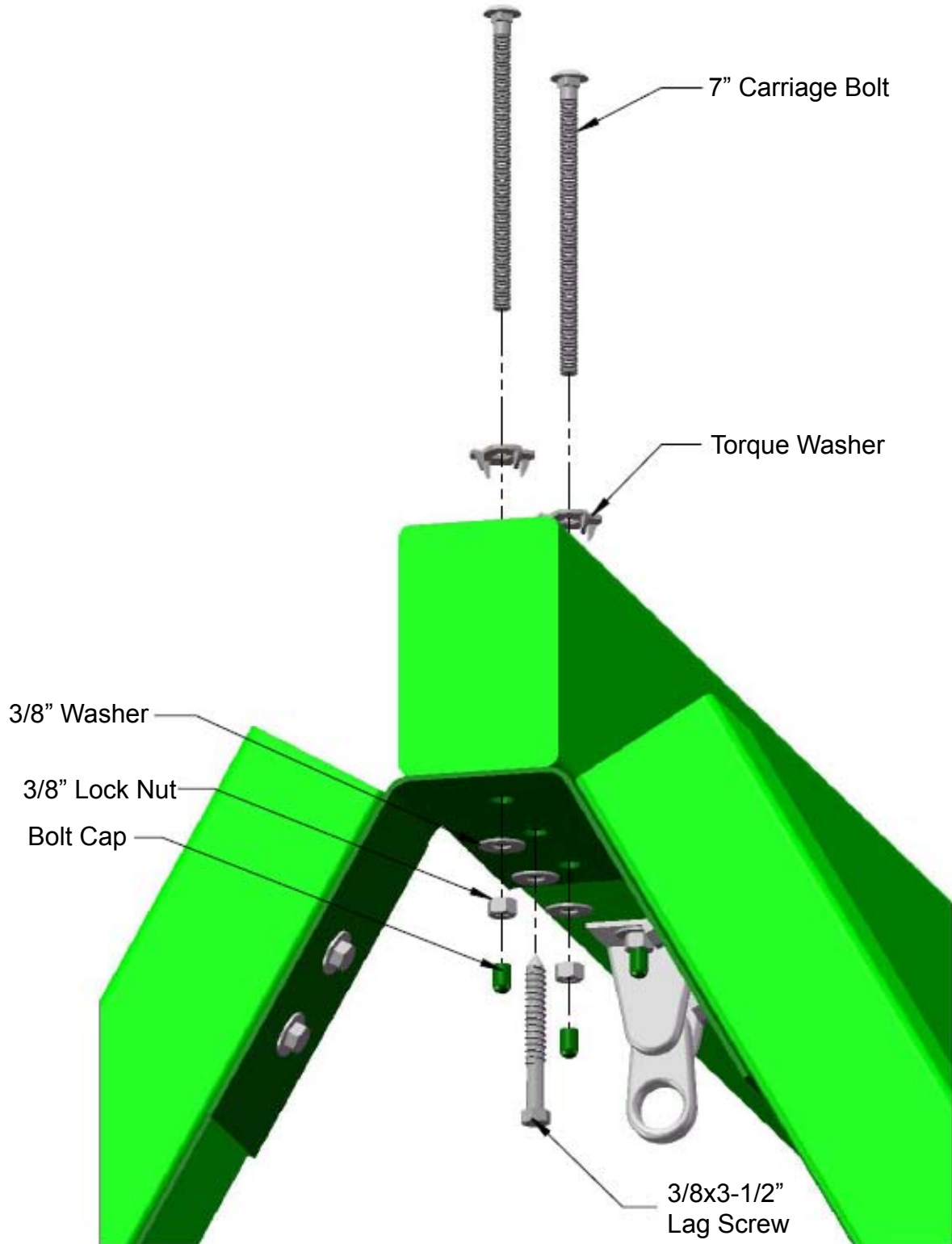

Step 26: Mount Swing Beam on Fort

In this step you will be mounting the Swing Beam to the fort. You will need your 9/16" socket wrench or impact wrench and pliers. An extra person is needed for this step

- 1: Raise the free end of the Swing Beam to fit on top of the Swing Beam Plate.
- 2: Line up the pilot hole at the end of the Swing Beam with the middle hole on the Swing Beam Plate.
- 3: Fasten the Swing Beam to the Swing Beam Plate and the Swing Beam Support using a 9" carriage bolt with a torque washer and a 3/8" lock nut with a 3/8" washer. Use a bolt cap to cover exposed threads.
- 4: Fasten the Swing Beam to the Swing Beam Plate from underneath with a 3/8 x 3-1/2" lag screw and 3/8" washer.

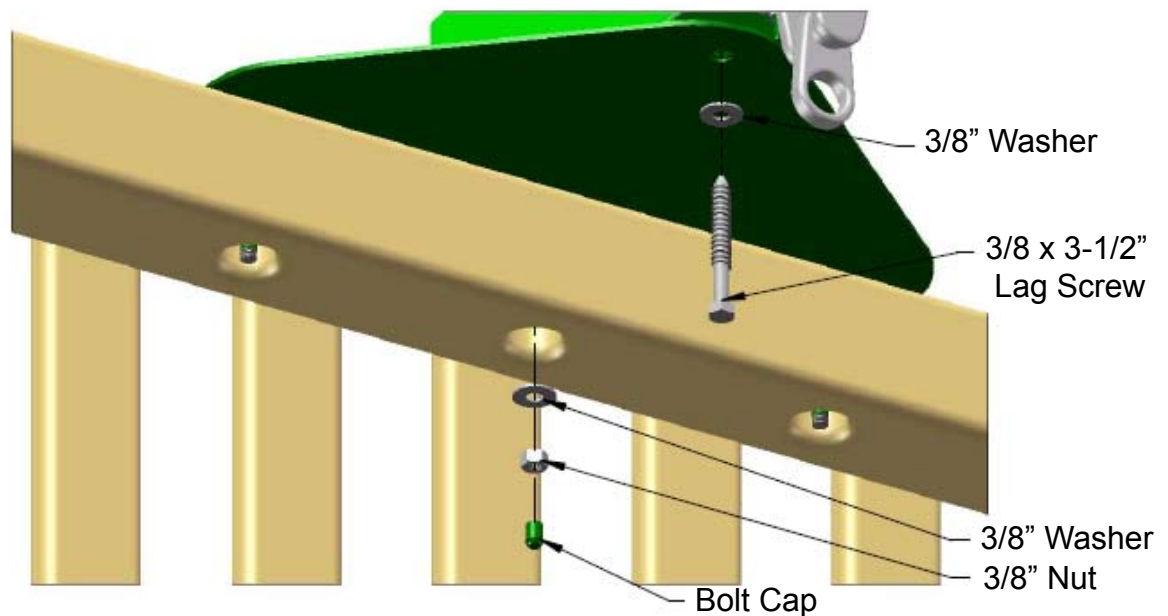
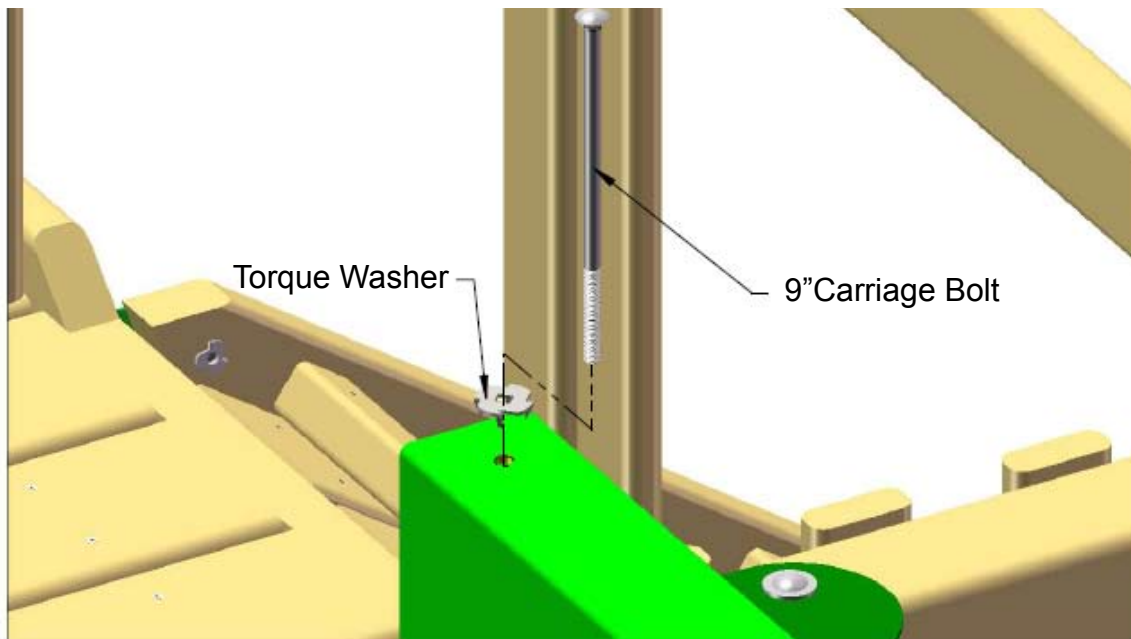

Step 27: Level Swing Beam

1: Place a level on top of the Swing Beam and adjust the Swing Legs in or out as needed to make the Swing Beam level.

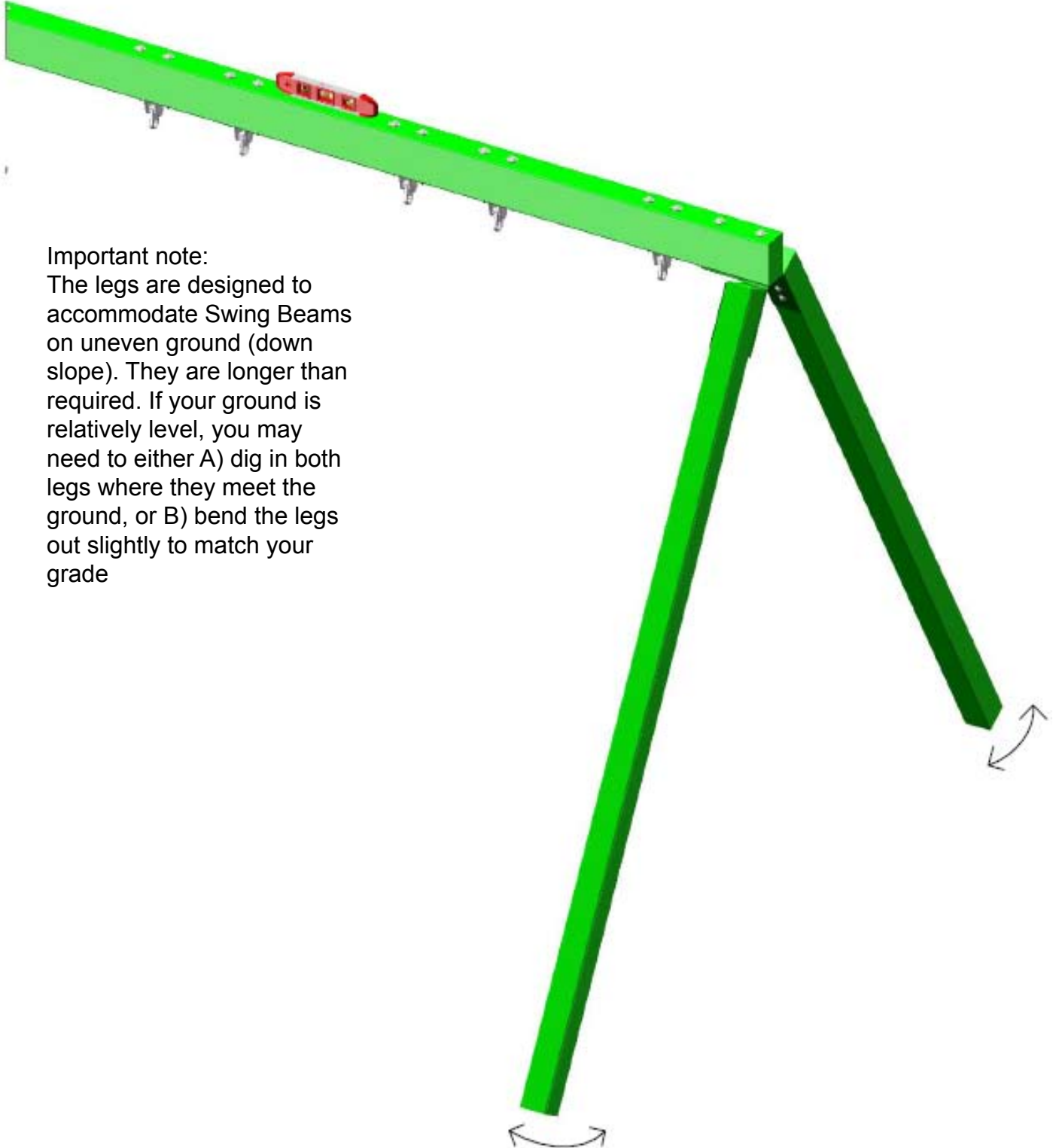

Important note:

The legs are designed to accommodate Swing Beams on uneven ground (down slope). They are longer than required. If your ground is relatively level, you may need to either A) dig in both legs where they meet the ground, or B) bend the legs out slightly to match your grade

Step 28: Swing Beam Cross-Member

- 1: Position the 2 x 4 x 58" Swing Beam Cross-Member against the Swing Legs.
- 2: Level the Swing Beam Cross-Member and mark the location of the securing holes inside the cross-member holes onto the Swing legs.
- 3: Use 3/8 x 3-1/2" lag screws with 3/8" washers to secure the Swing Beam Cross-Member to the Swing Legs.

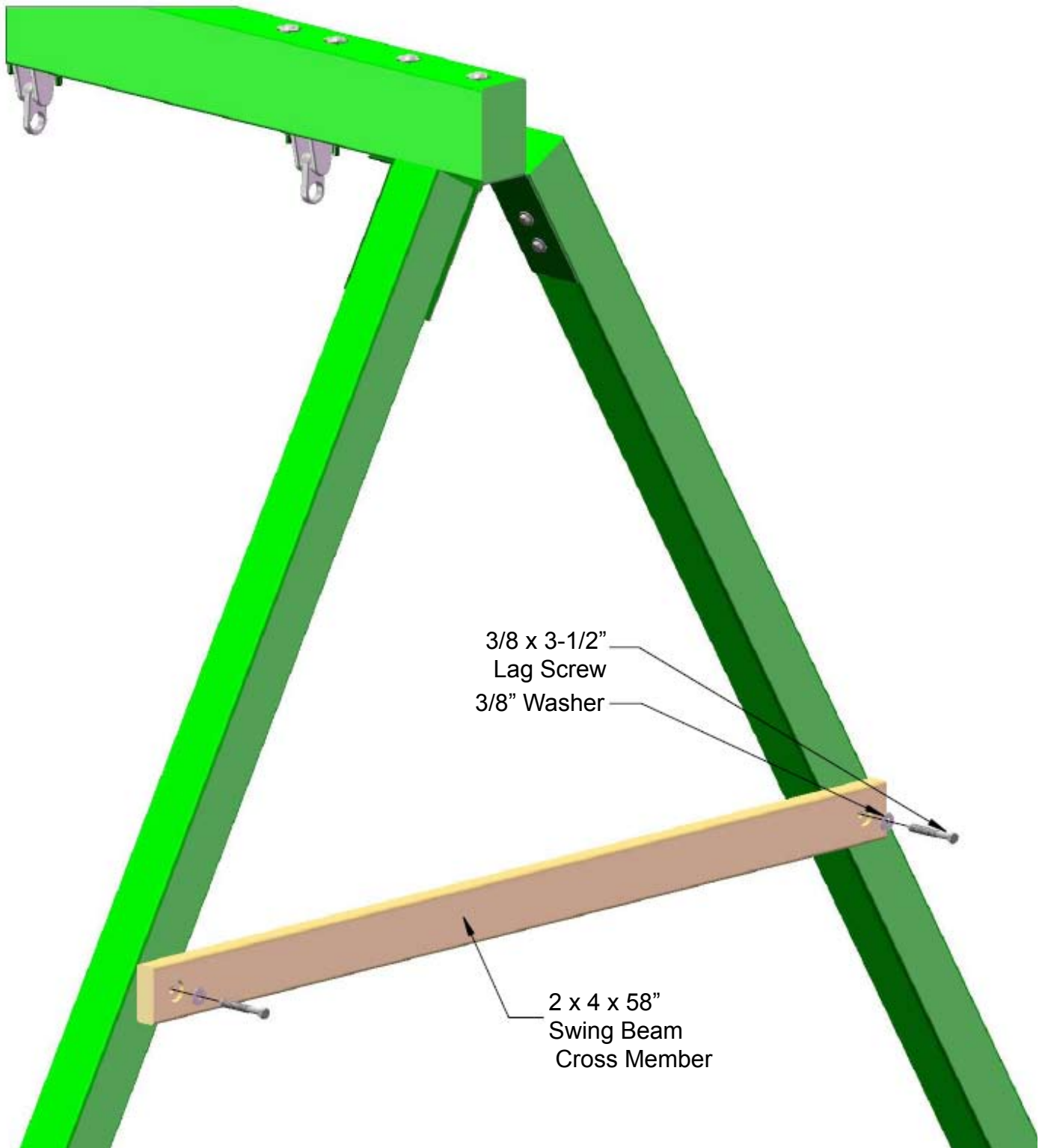

Step 29: Roof Supports

1: With offset holes down, attach the 2 x 4 x 51" Roof Supports to the fort with 5/16 x 4-1/2" hex bolts and 5/16" washers. The Roof Supports should meet in the middle to form a right angle.

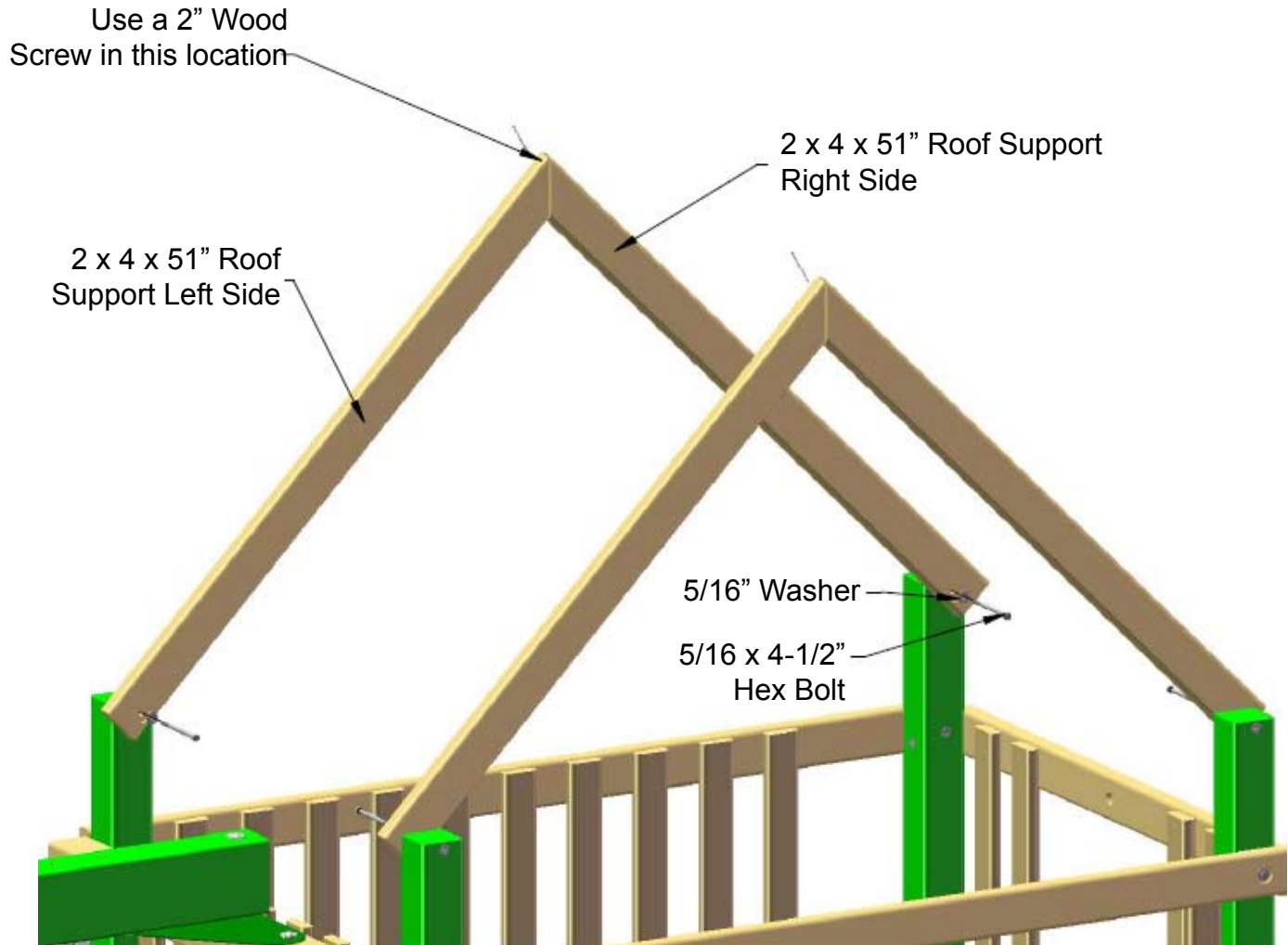

Step 30: Roof Peak Support

- 1: Pre-drill holes in the 5/4 x 10" Roof Peak Supports to the pattern shown below.
- 2: Place the 5/4 x 10" Roof Peak Support against the angled Roof Supports. Fasten the Roof Peak Support to the angled Roof Supports with 1-1/2" wood screws
- 3: Repeat for other side.

5/4 x 10" Roof Peak Support

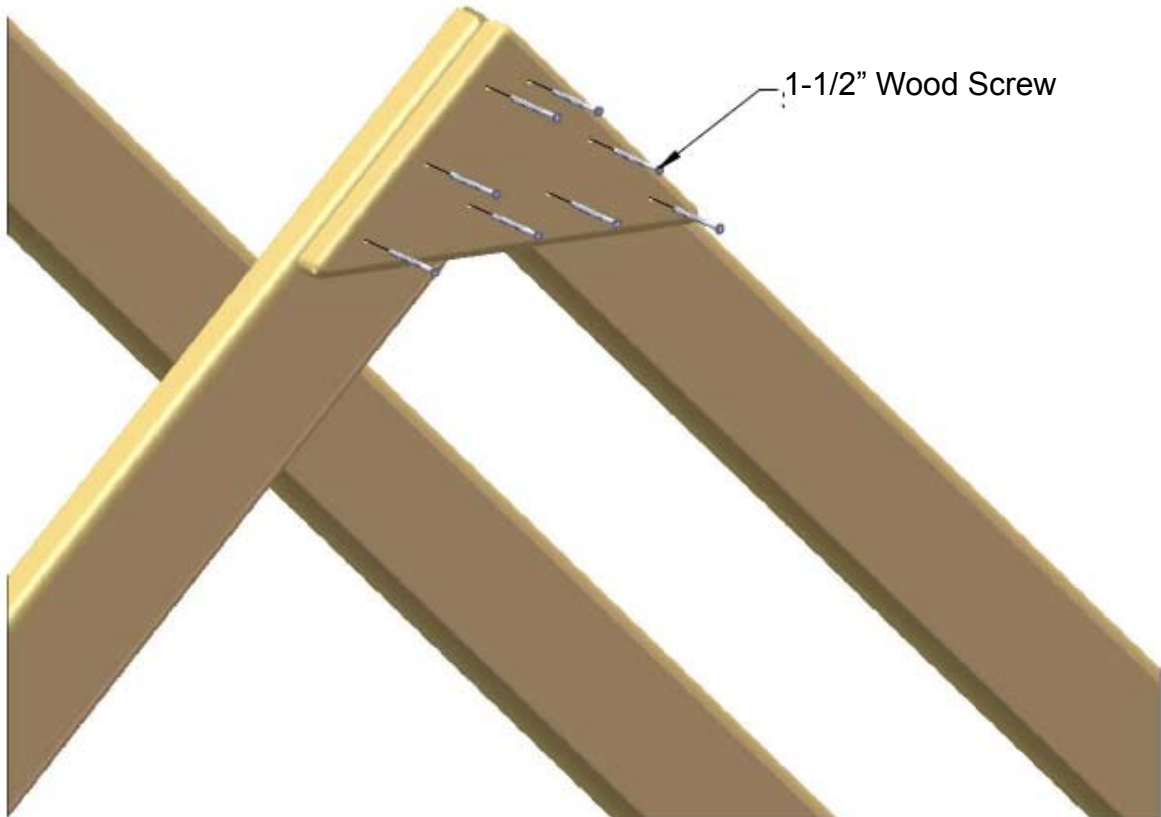
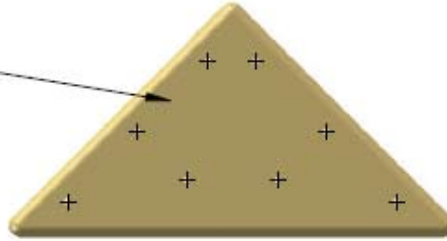

Step 31: Roof

- 1: Place the 1 x 4 x 47-1/2" Groove-Only Roof Starter Boards at the peak of the roof. The holes in the Roof Starter Boards should be centered on the Roof Supports, and the smooth sides of the Roof Starter Boards should be placed as close to each other as possible without the boards overlapping.
- 2: Fasten the Roof Starter Boards to the Roof Supports with 1-1/2" wood screws.

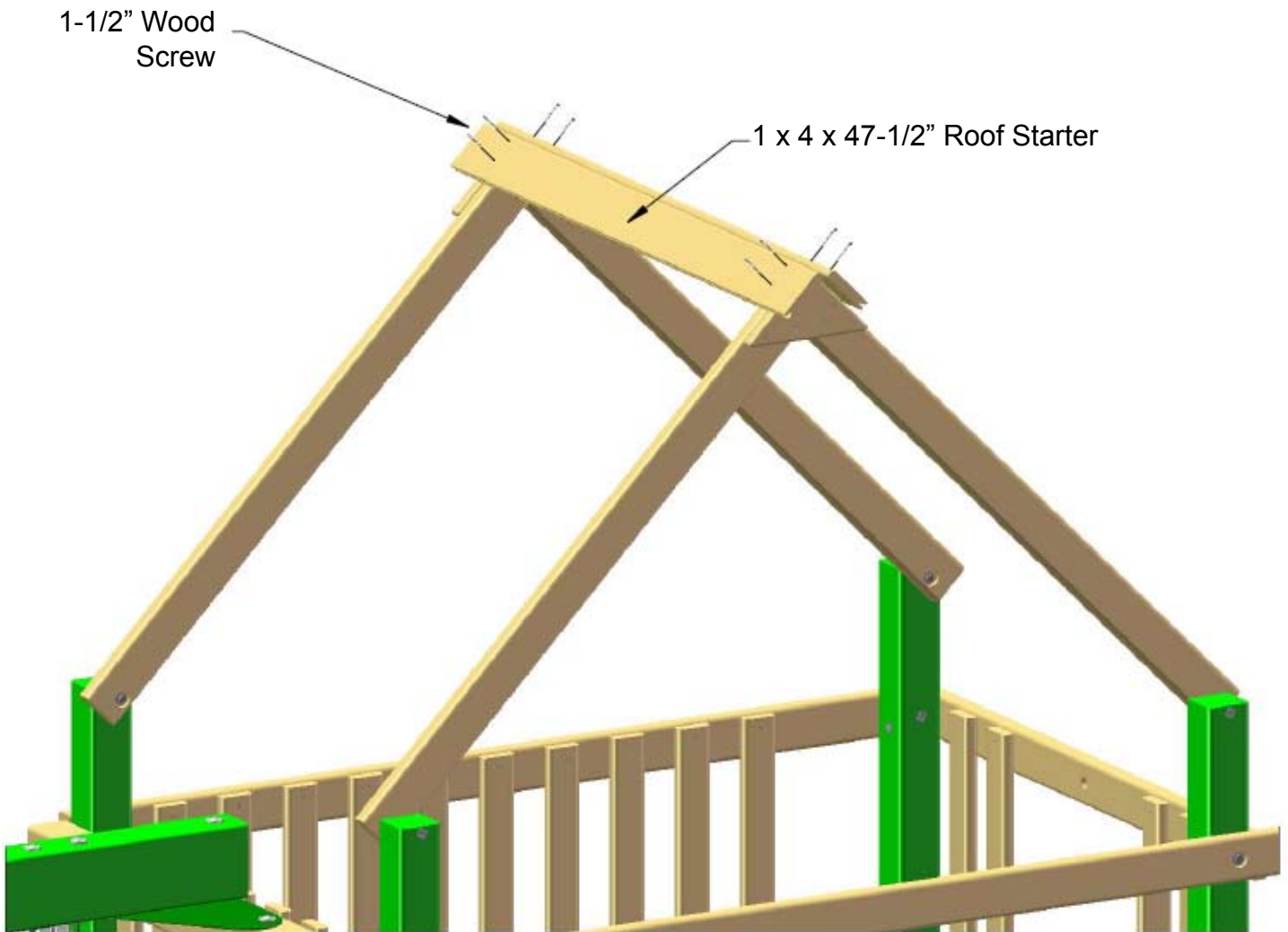

Step 32: Roof

- 1: Place the 47-1/2" Roof Peak on top of the Roof Starter Boards.
- 2: Fasten the Roof Peak to the Roof Starter Boards with 1-1/2" wood screws.

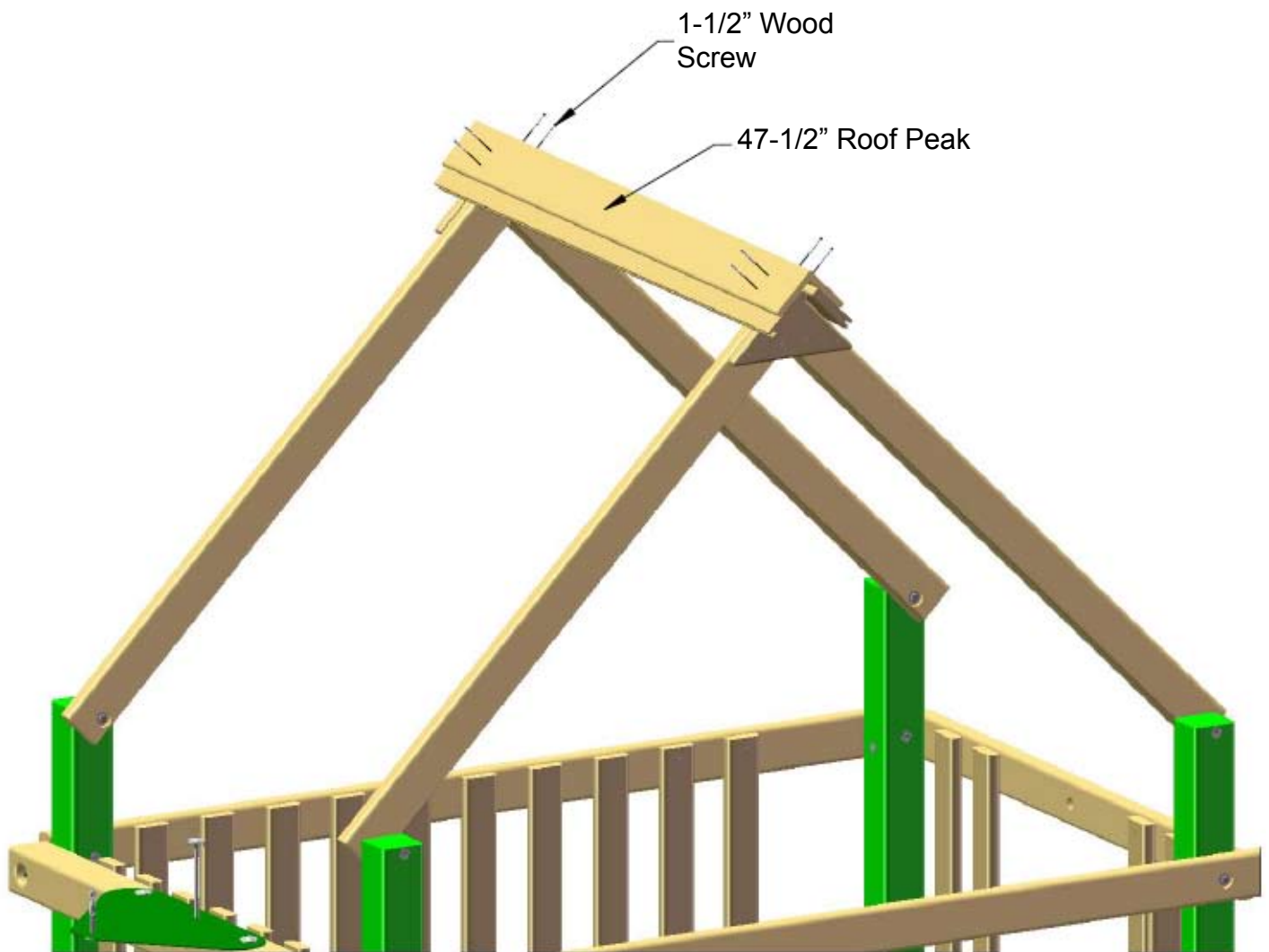

Step 33: Roof

- 1: Place the 1 x 6 x 47-1/2" Roof Boards on top of the Roof Supports, fitting the tongue end into the groove end of the Roof Starter boards. Each side of the roof gets nine Roof Boards.
- 2: Fasten the Roof Boards to the Roof Supports with 1-1/2" wood screws.
- 3: Place a 1 x 4 x 47-1/2" Roof Finisher on each end of the roof, and fasten with 1-1/2" wood screws.

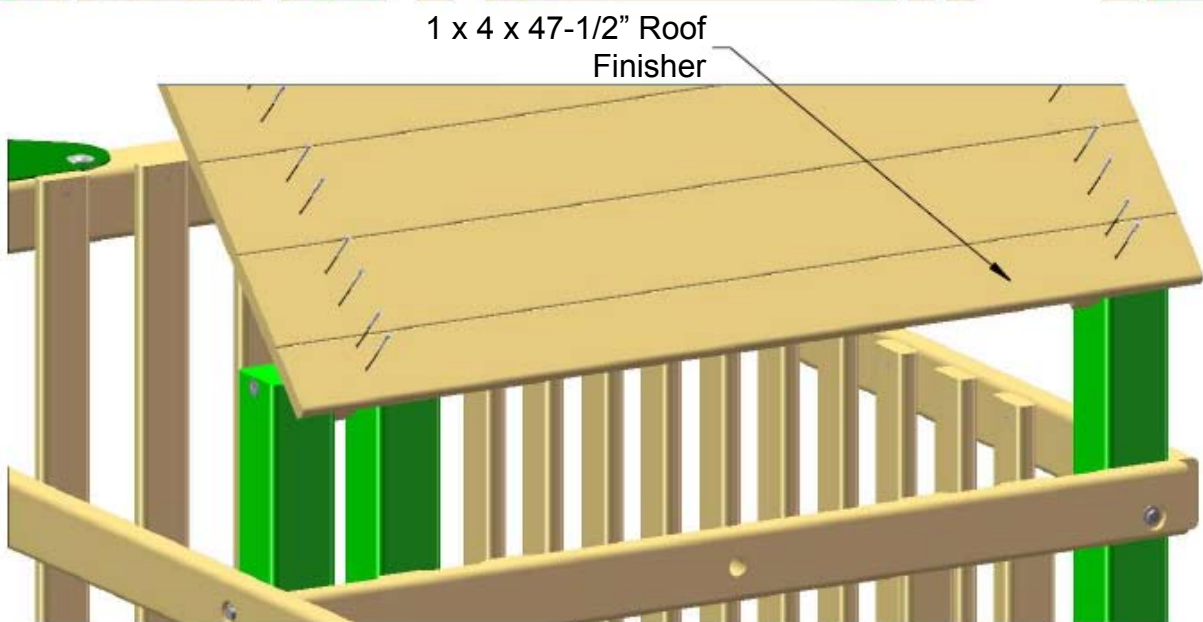
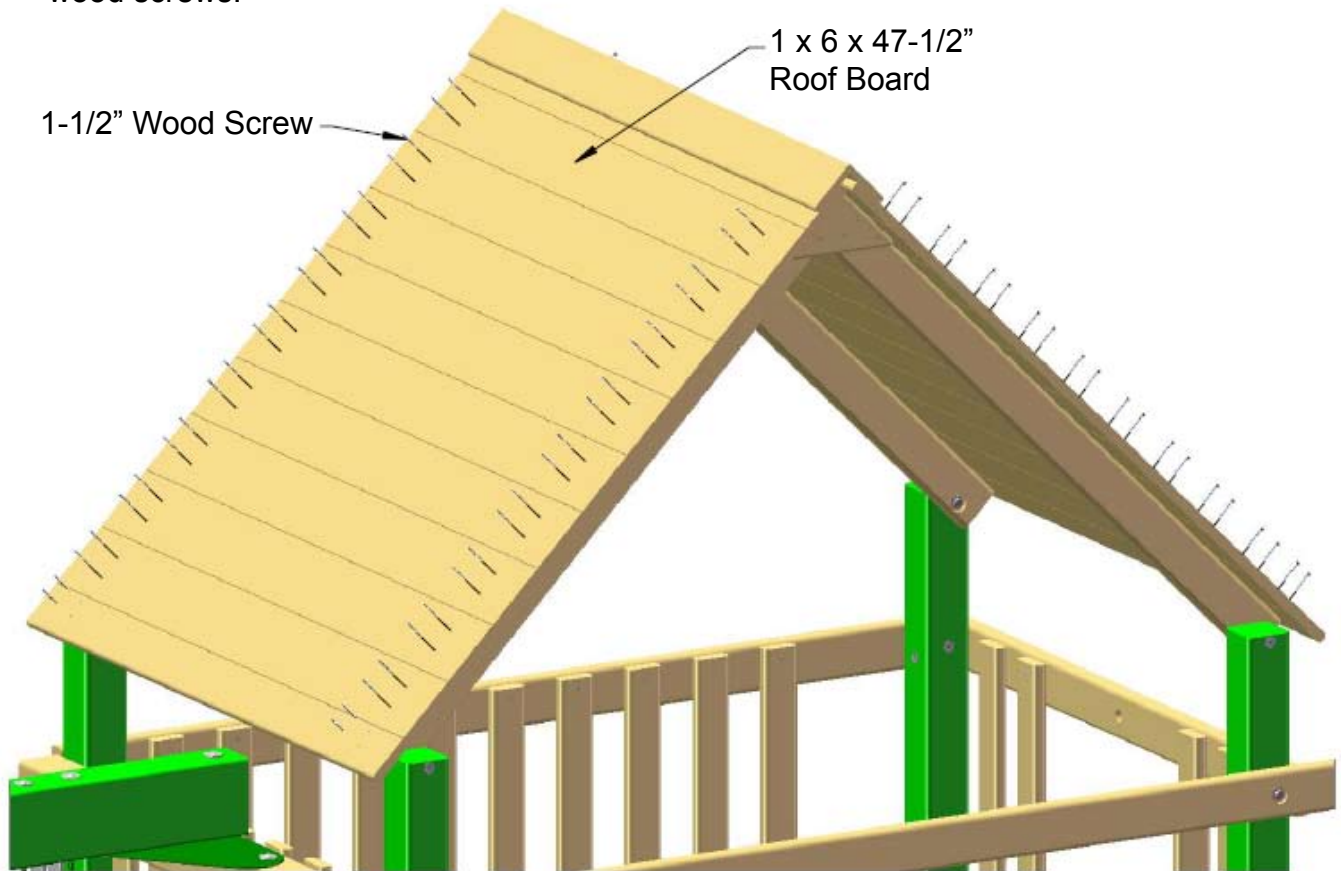

Step 34: Sunburst

1: Pre-drill holes in the 2 x 6 x 16" Sun to the pattern shown below.

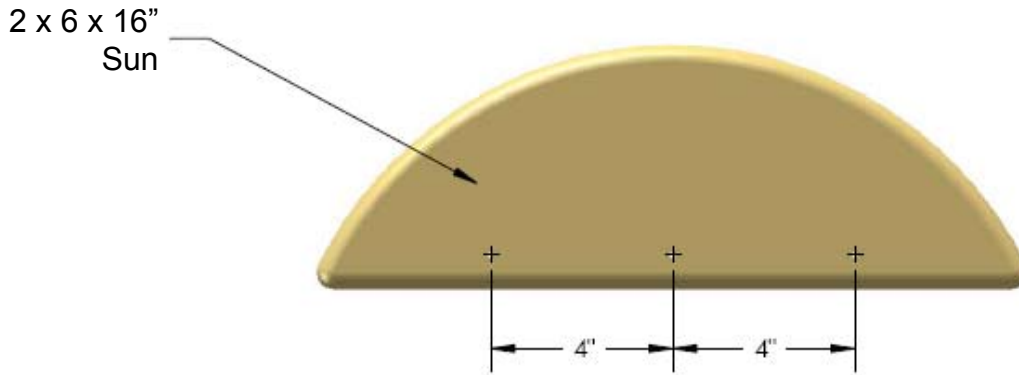

2: Place the 2 x 6 x 16" Sun centered against the 5/4 x 2-5/8 x 42" Sun Support. Fasten the Sun to the Sun Support with 2" wood screws.

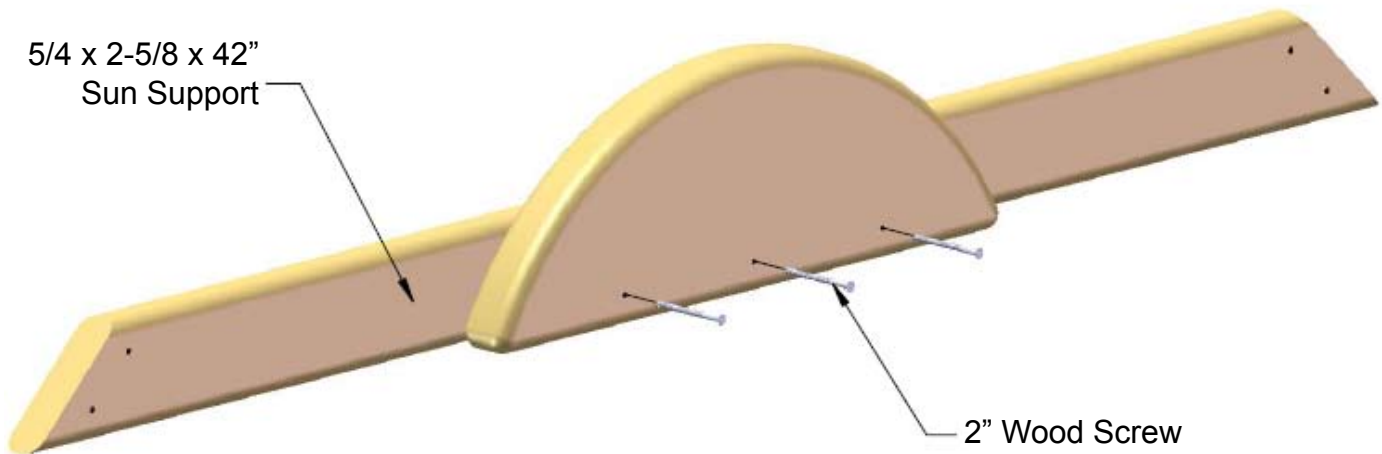

Step 35: Sunburst

- 1: Place the Sun Assembly made in the previous step against the angled Roof Supports, with the ends of the Sun Support flush to the sides of the angled Roof Supports. Make sure that the Sun Support board is level before proceeding to the next step.
- 2: Fasten the Sun Assembly to the fort with 2" wood screws from the outside into the Roof Supports.
- 3: Repeat this process for the rear of the fort.

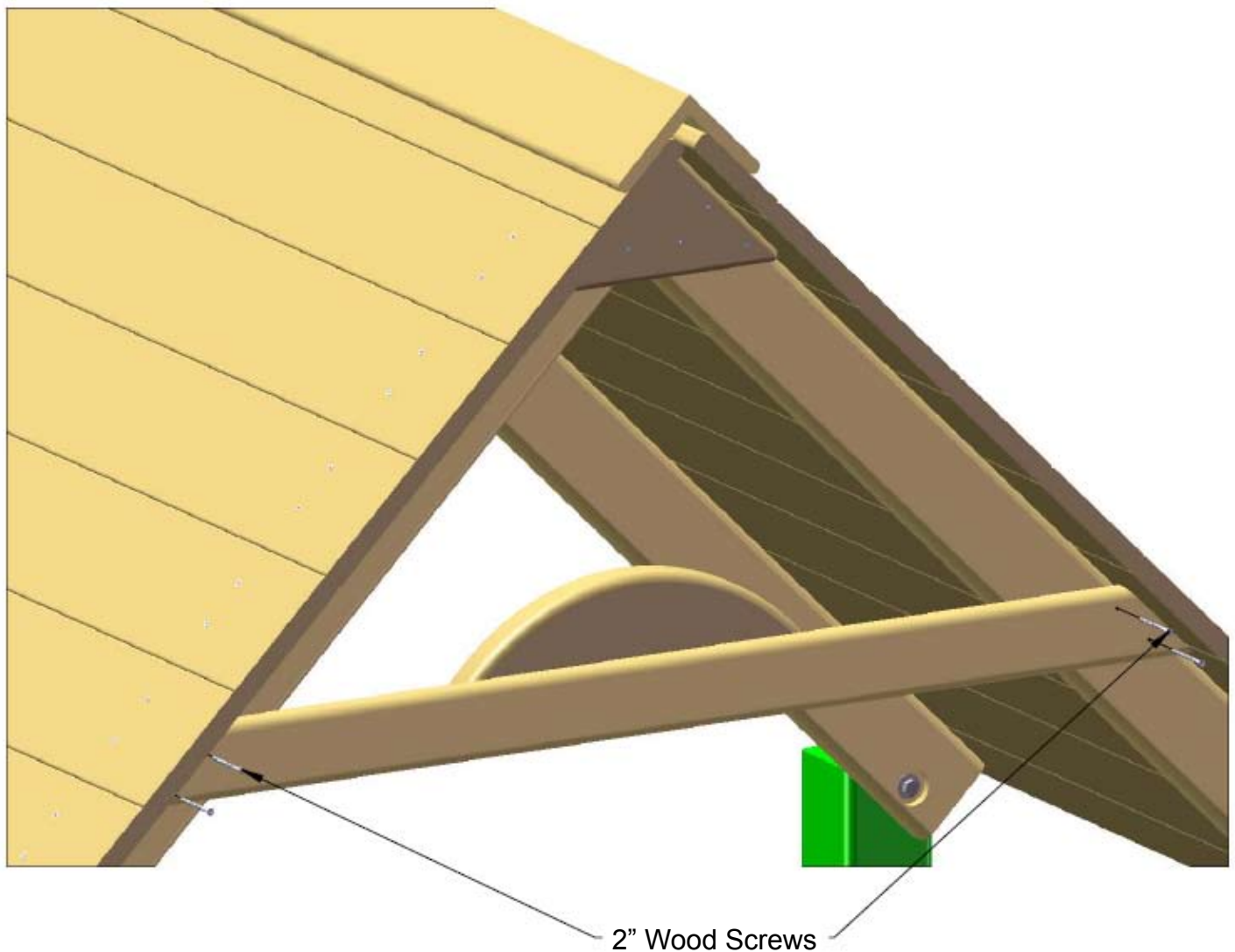

Step 36: Sunburst

- 1: Center the 5/4 x 2 x 16" Large Ray onto the Sun and the Roof Support Boards and fasten with two 1-1/2" screws.
- 2: Equally space the Small Rays about the Sun (three on each side of large ray) and mark the position of the Small Rays with a pencil.
- 3: Secure the Small Rays one at a time to the Sun and the Roof Support Boards and line them up with the mark drawn. Fasten the Small Rays with two 1-1/2" wood screws each. Repeat on other side of fort.

Note: Roof Boards removed from view for clarity

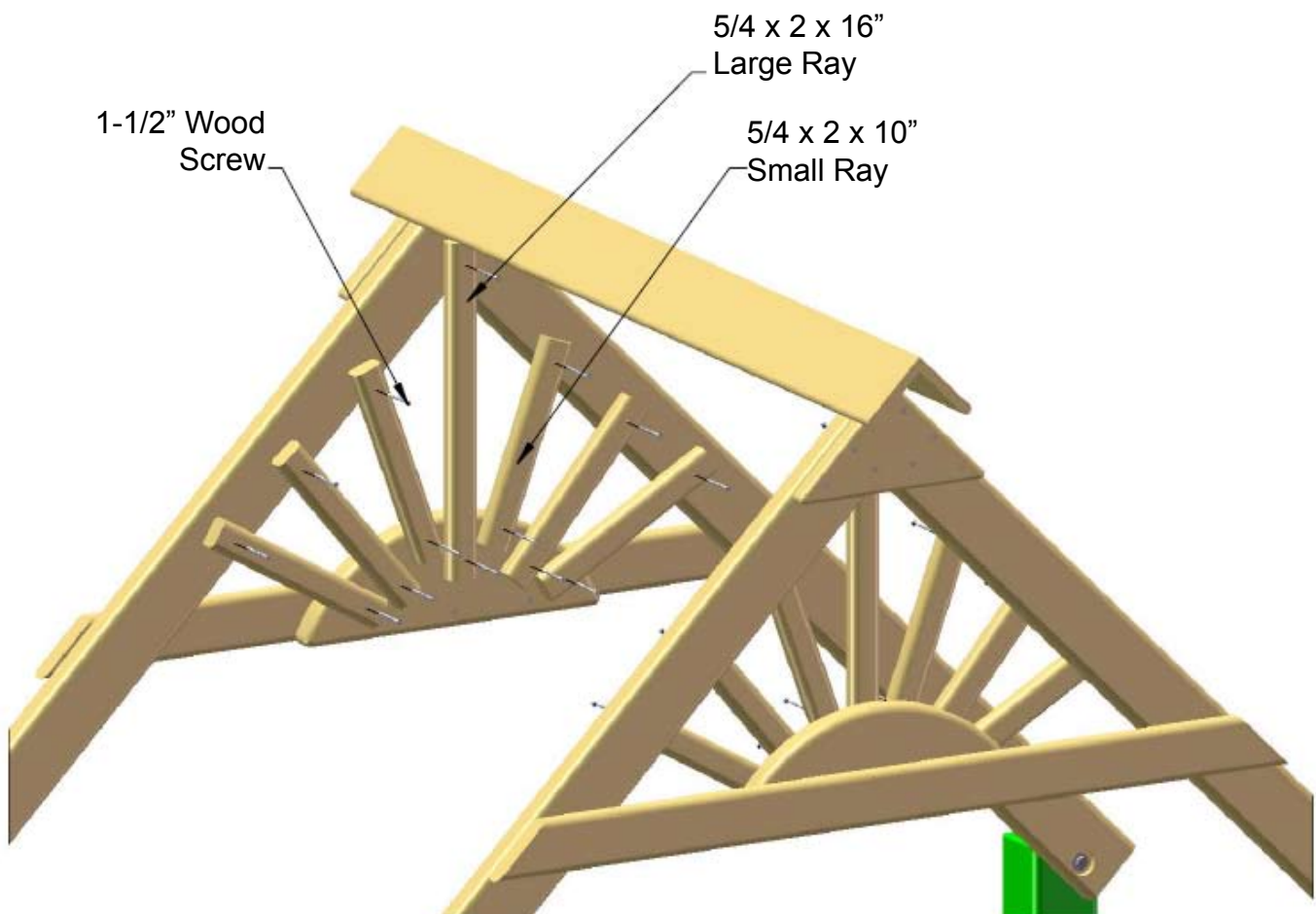

Step 37: Hanging the Swings

- 1: Start by attaching one Spring Clip to each Iron Ductile Swing Hanger on the Swing Beam.
- 2: Attach one chain per accessory to each Spring Clip.
- 3: Adjust height as needed

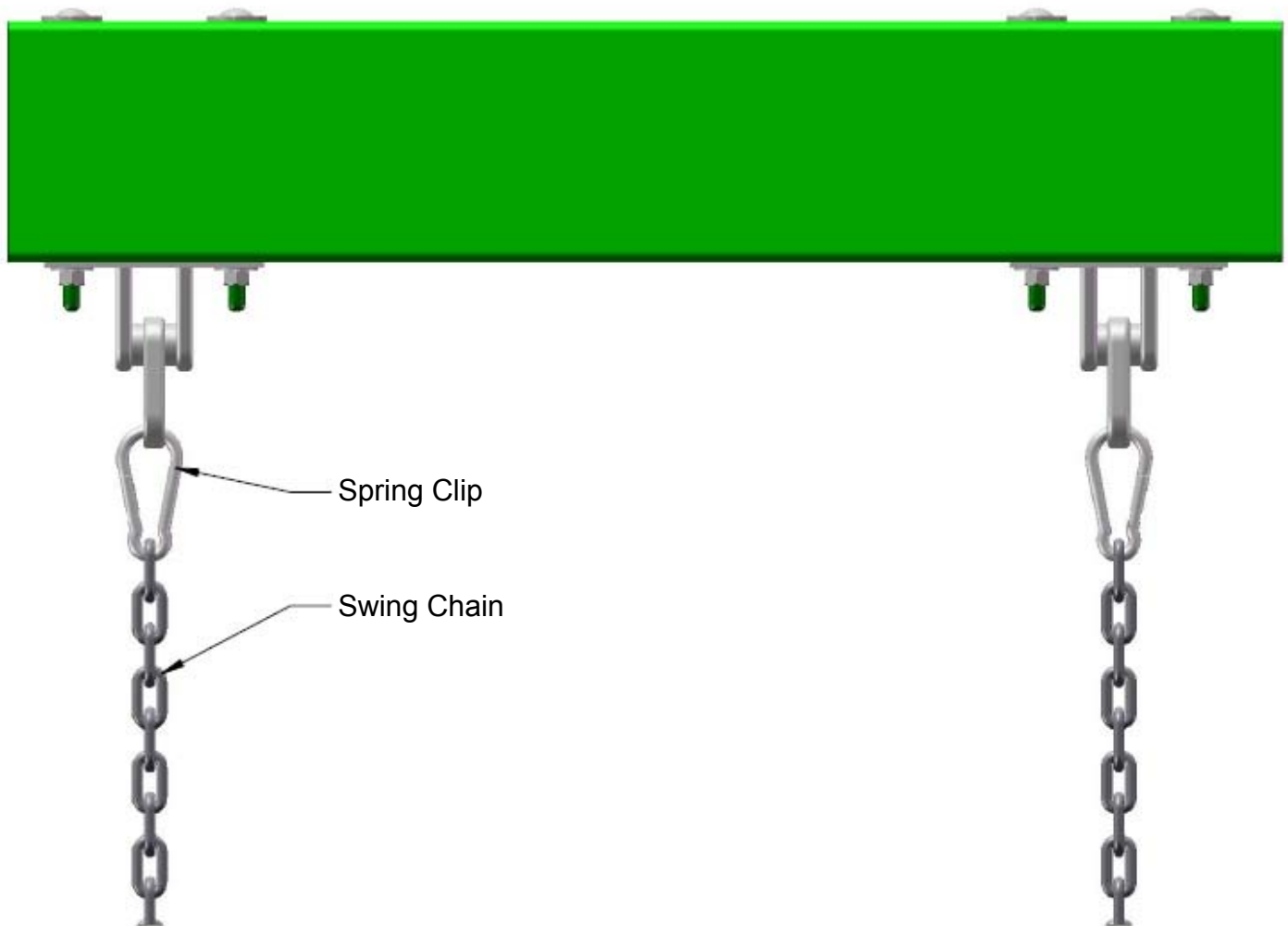

Step 38: Safety Board

1: Measure 24" from the bottom of the Corner Posts on the left side of the fort. Mark these positions on the outside of the Corner Posts. Attach the 2 x 4 x 47-1/2" Safety Board with holes offset up or down (your choice) to the Corner Posts with 5/16 x 3-1/2" lag screws and 5/16" washers.

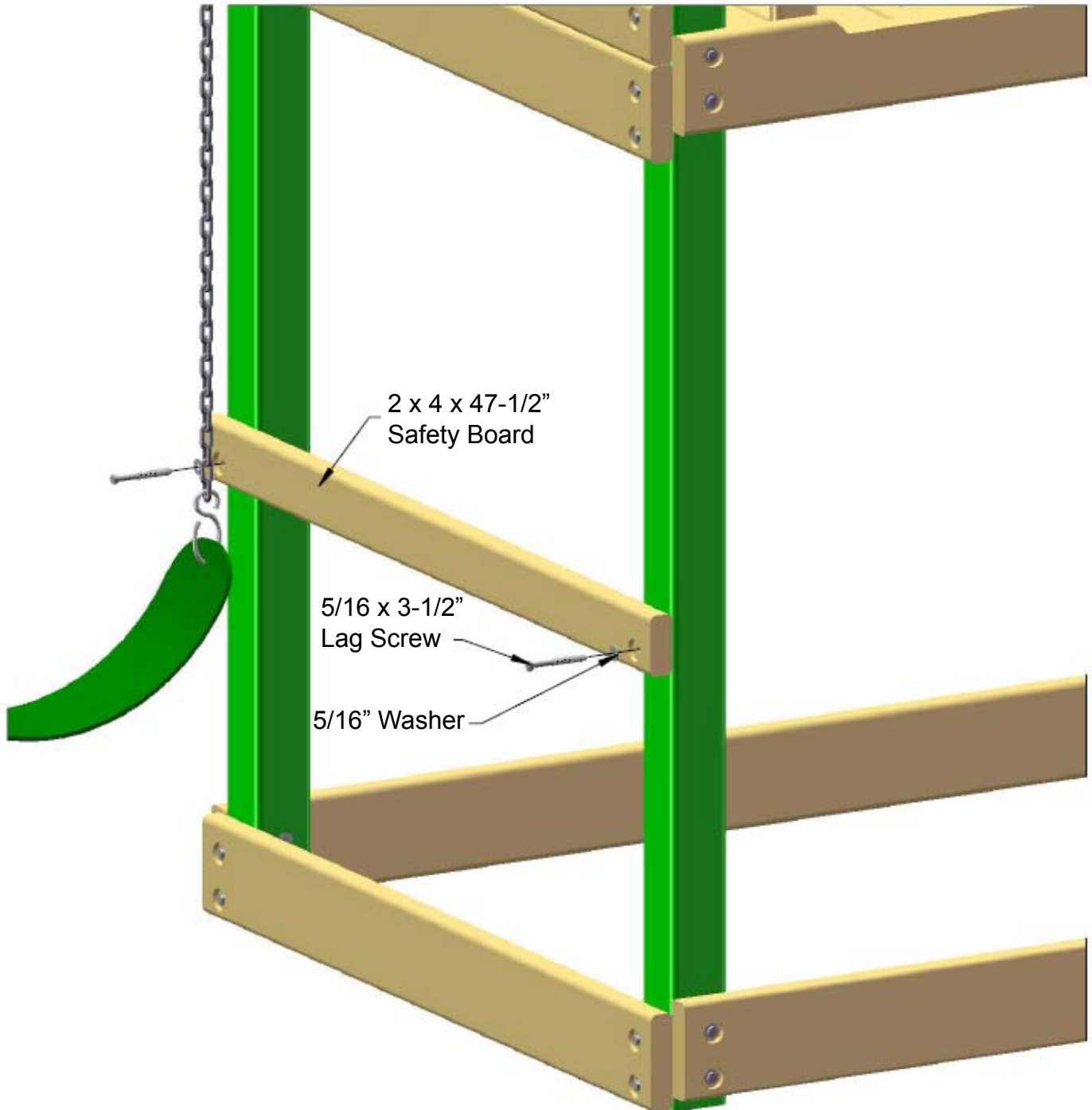

Step 39: Picnic Table

- 1: Place the 2 x 4 x 15" Picnic Table Support on top of the 2 x 4 x 30" Picnic Table Vertical Support and position the boards at a right angle.
- 2: Ensure that the Picnic Table Support and the Picnic Table Vertical Support are square and fasten the Picnic Table Support to the Picnic Table Vertical Support with three 2-1/2" wood screws in the pattern shown below. Make sure to assemble the Picnic Table Support and the Picnic Table Vertical Support to accommodate opposite sides of the picnic table. Make sure the assembly is square before proceeding to the next step.
- 3: Measure out 15" on the Sandbox Boards from the outside of the corner posts to ensure that the assembly is square.
- 4: Fasten the assembly created from the previous two steps to the Corner Post. Position the assembly so that the Picnic Table Support is on the outside of the Corner Post, and the Picnic Table Vertical Support is on the inside of the 2 x 6. Fasten the assembly to the unit with three 2" wood screws in the Picnic Table Support, and two 2-1/2" wood screws in the 2 x 6 at the bottom. (See pattern below)

Complete this step first. (See sub-steps 1 and 2.)

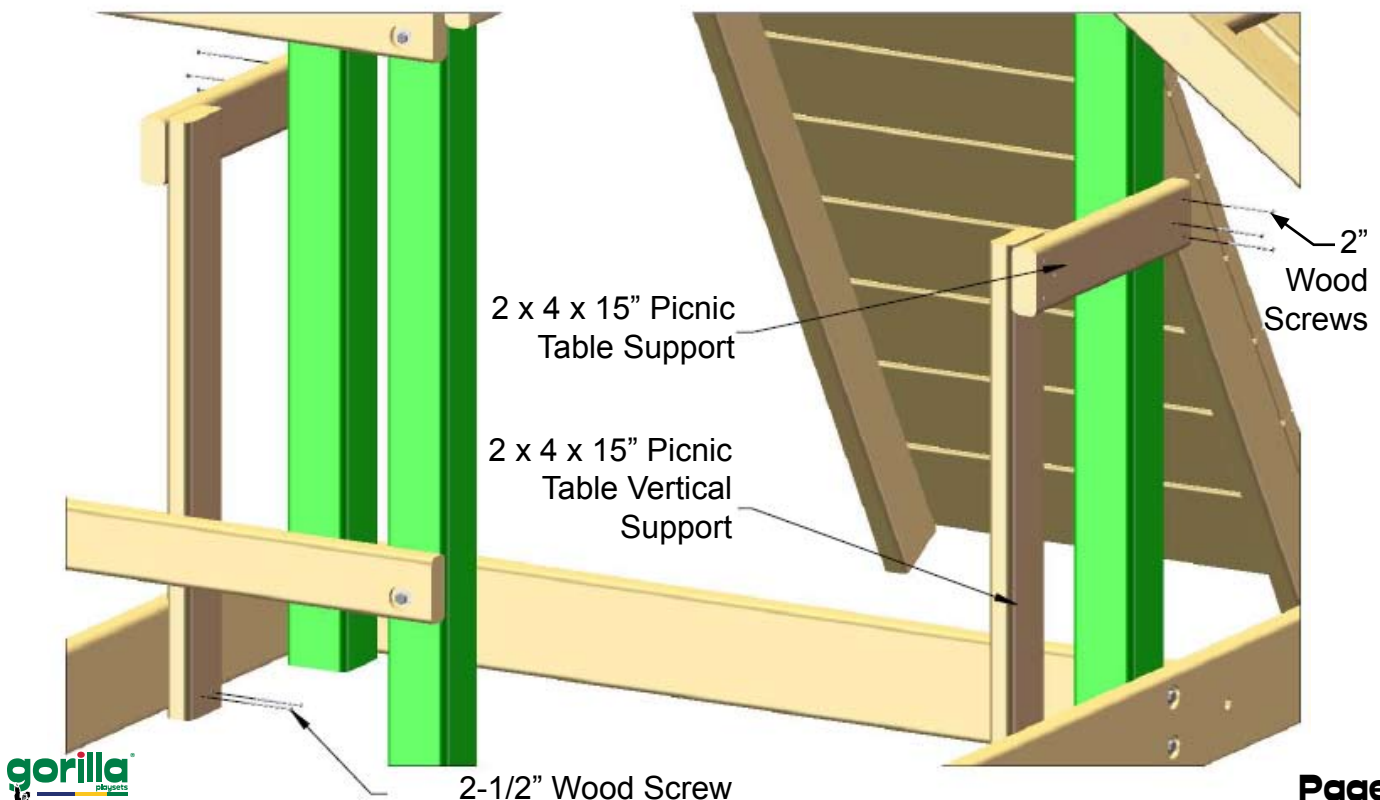
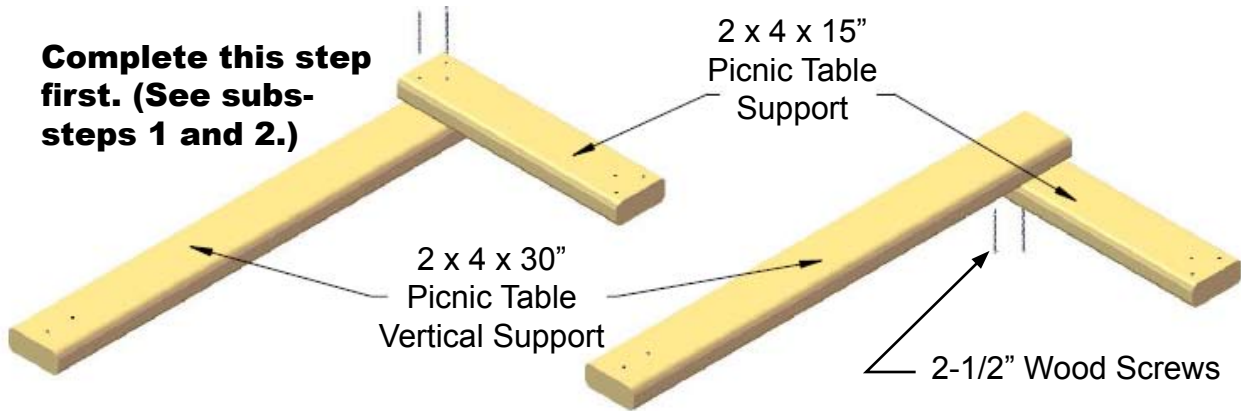

Step 40: Picnic Table

- 1: Measure 18" from the ground up and mark this point on the Corner Post.
- 2: Place the 2 x 4 x 23" Picnic Table Bench Support on the outside of the Corner Post so that the top is at 18" from the ground. Level the Bench Support, then attach it with three 2-1/2" wood screws to both the Corner Post and the Vertical Support.
- 3: Repeat these steps for the opposite side of the play set.

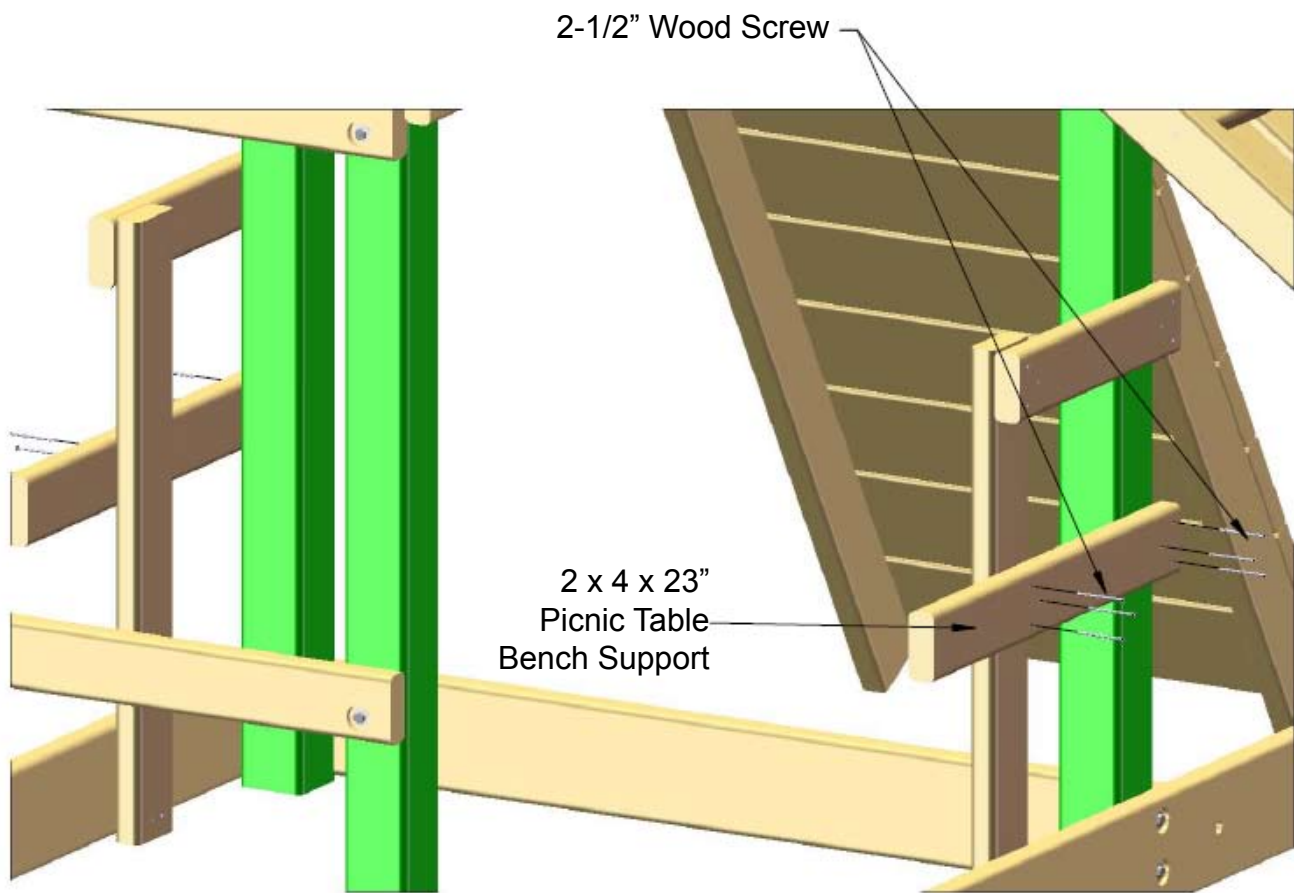

Step 41: Picnic Table

- 1: Attach the Picnic Table Seat to the Bench Supports with two 2" wood screws in each end.
- 2: Attach the Picnic Table Tops to the Table Supports with two 2" wood screws in each end.

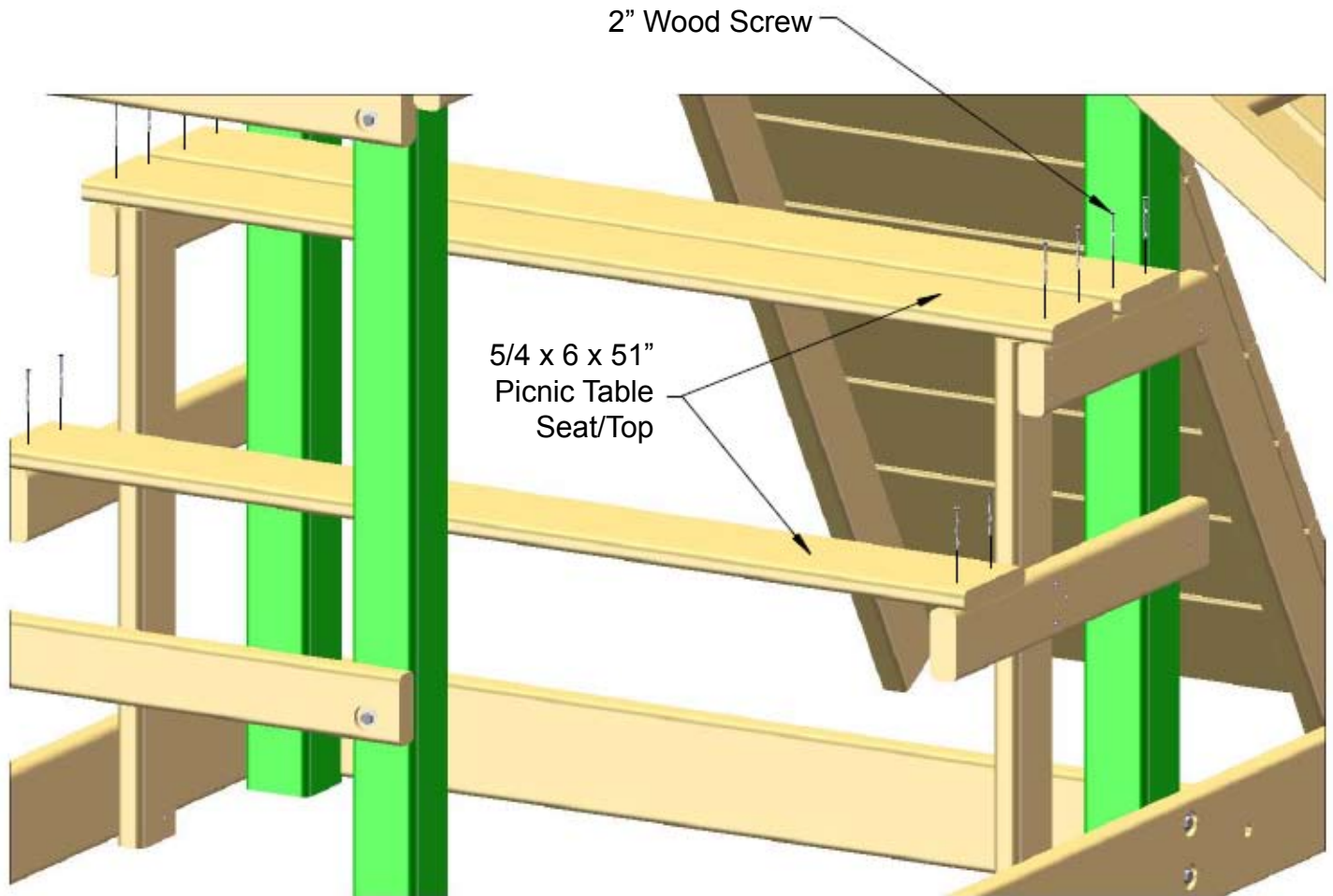

Step 42: Tire Swing

- 1: Place the 4 x 4 x 72" Tire Swing Legs flush to the top of the Swing Leg Bracket.
- 2: Fasten the Tire Swing Legs to the Swing Leg Bracket with 3/8 x 3-1/2" lag screws and 3/8" washers.

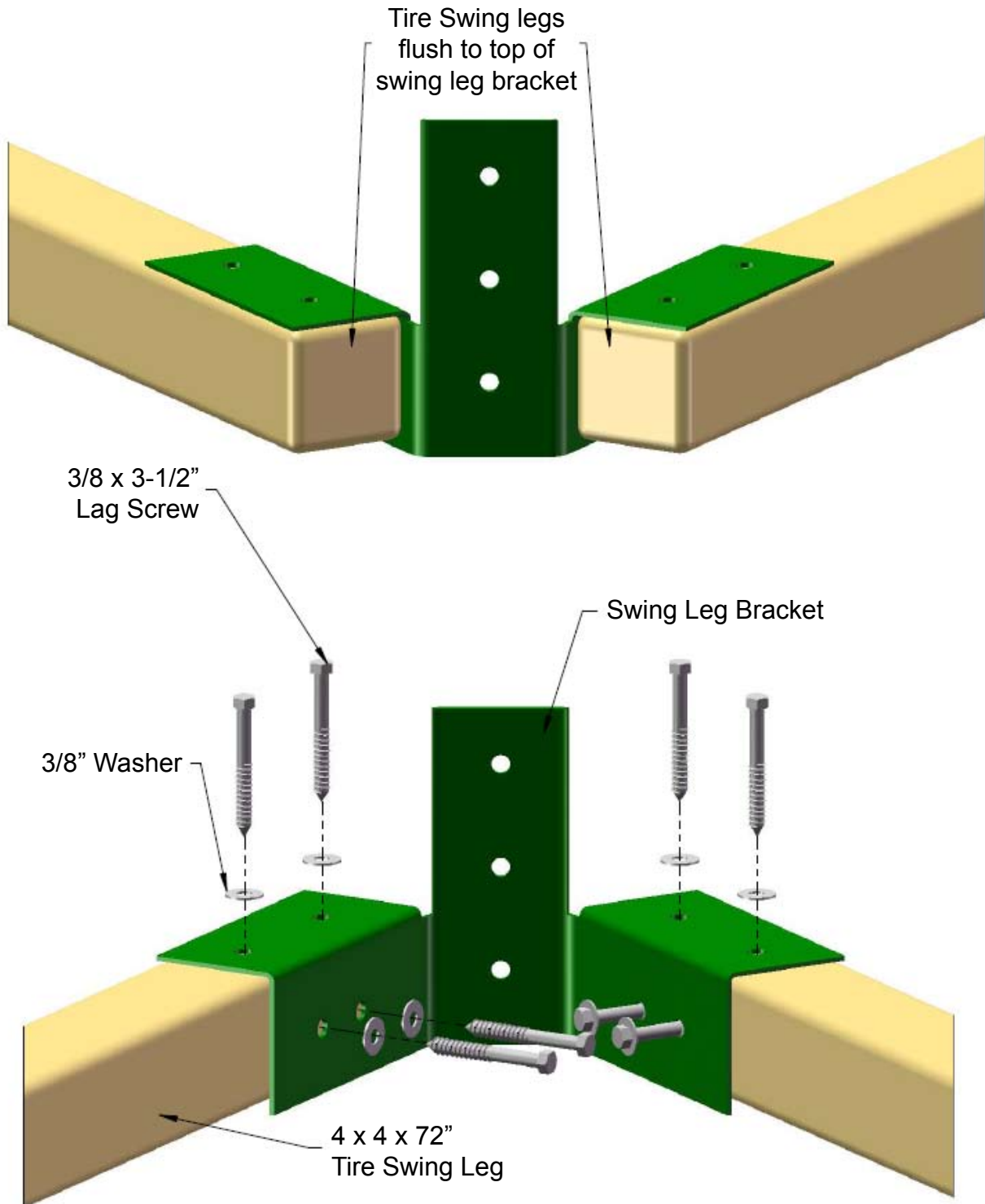

Step 43: Tire Swing

- 1: Line up the holes of the Tire Swivel with the holes in the Tire Swing Beam.
- 2: Fasten the Tire Swivel to the Tire Swing Beam using 7" carriage bolts with torque washers, and 3/8" washers with 3/8" lock nuts.
- 3: Place bolt caps over exposed threads.

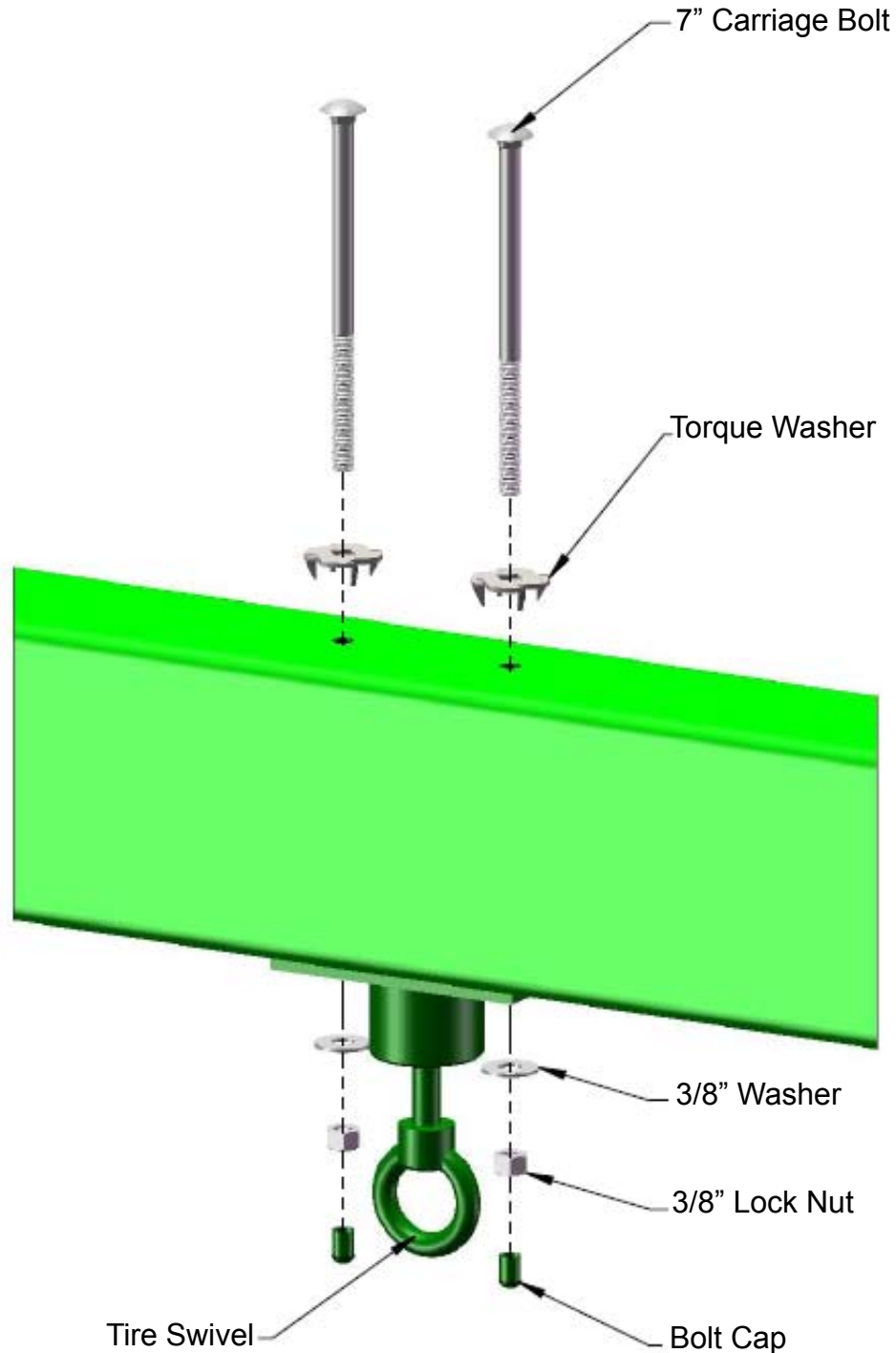

Step 44: Tire Swing

- 1: Fasten the Tire Swing Beam to the Swing Leg Bracket using 7" carriage bolts with torque washers on top of the Tire Swing Beam, and 3/8" lock nuts with 3/8" washers from underneath.
- 2: Use a 3-1/2" lag screw with 3/8" washer for the hole in the center of the Swing Leg Bracket.
- 3: Place a bolt cap over any exposed threads.

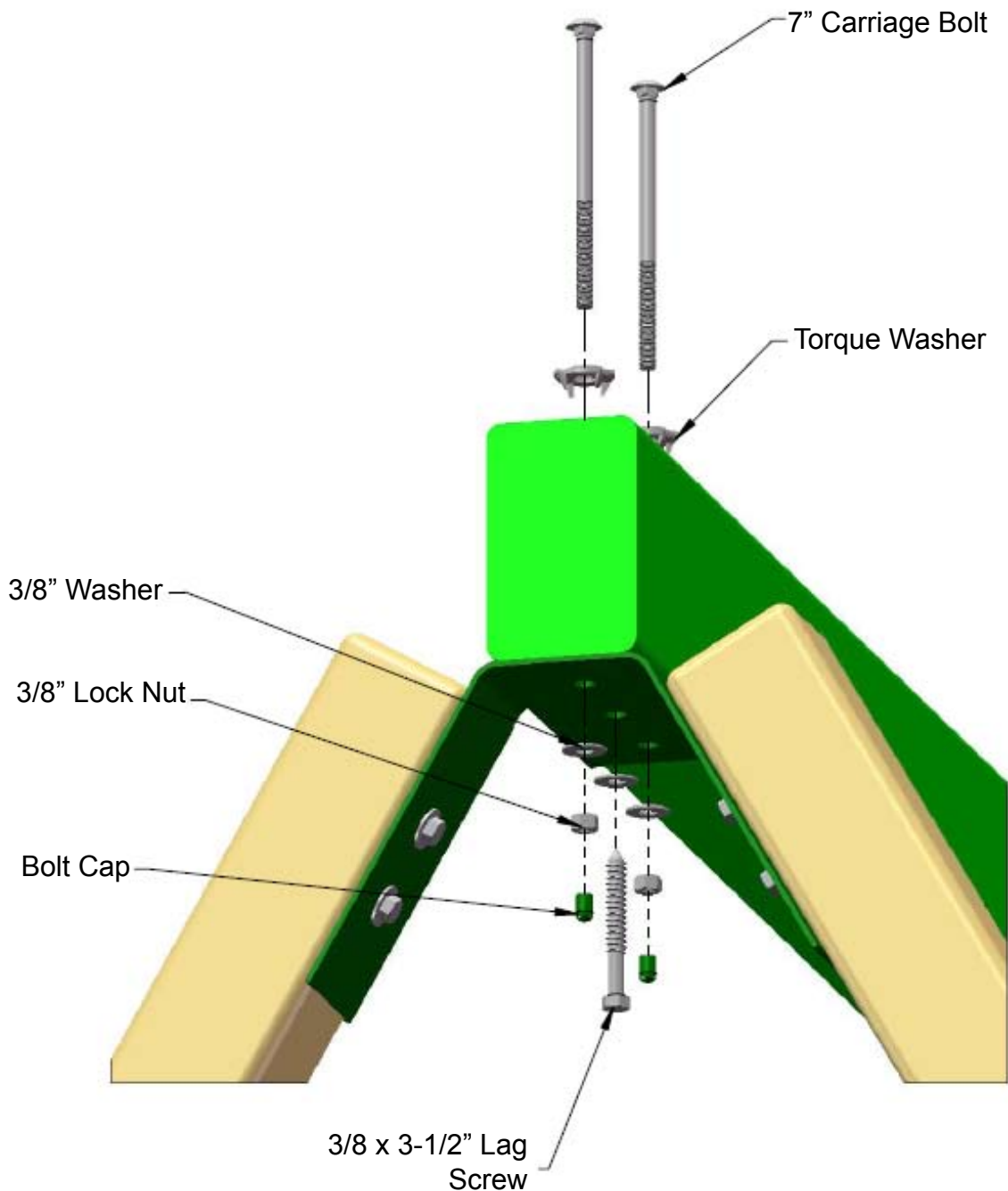

Step 45: Tire Swing

IMPORTANT: Note the Tire Swing Legs are designed to accommodate swing beams on uneven ground (down slope). They are longer than required. If your ground is relatively level, you may need to either A) dig in both legs where they meet the ground, or B) bend the legs out slightly to match your grade. (ALSO SEE STEP 47)

An extra person is needed for this step.

- 1: Sit the Swing Beam Legs upright.
- 2: Take the assembled Tire Swing Beam and Swing Legs and insert the Swing Beam into the gap between the back right Corner Post and the Panel Slat. Place a small level on top of the beam in order to level correctly.
- 3: With a 3/8" drill bit, use the pre-drilled holes in the end of the Tire Swing Beam as a template for the holes that will be drilled into the corner post.

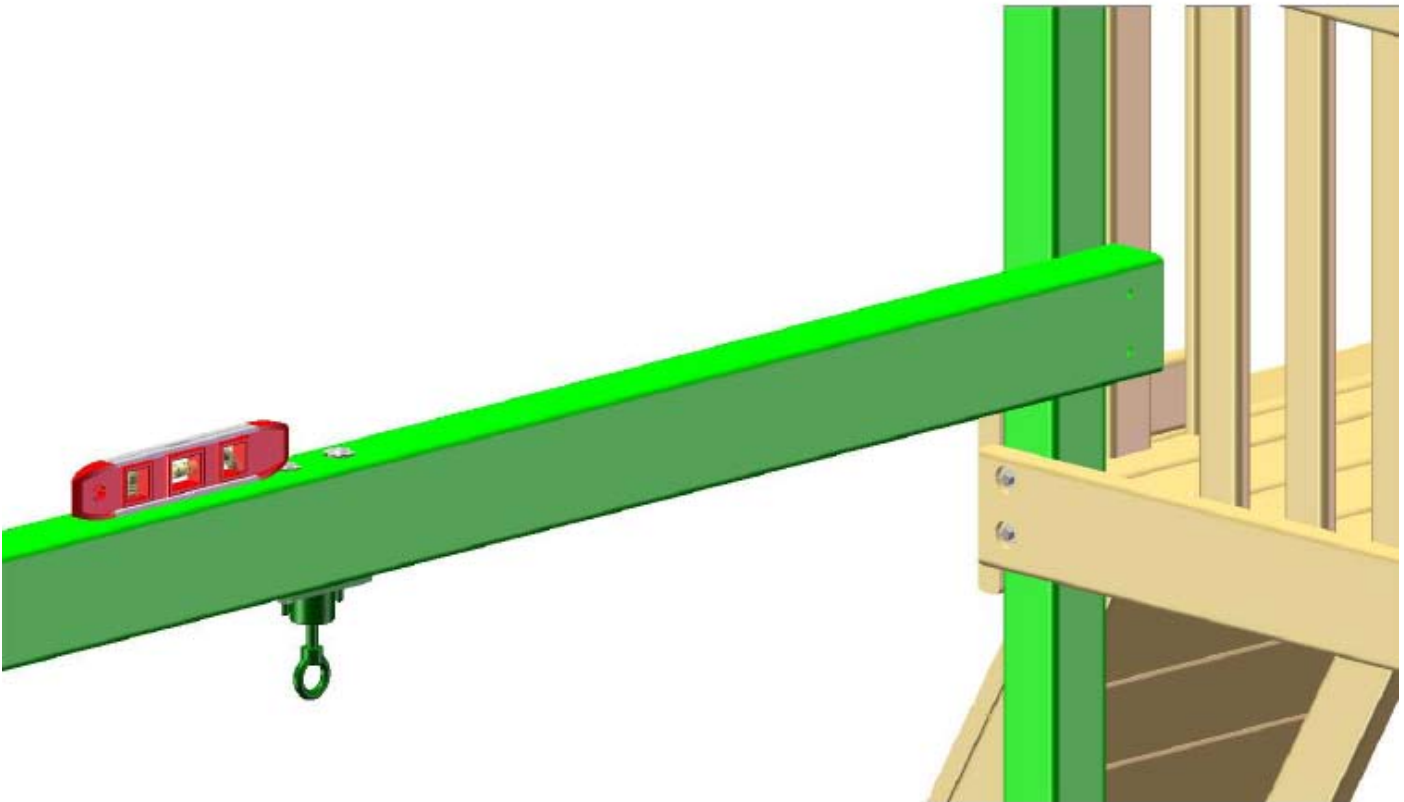

Step 46: Tire Swing

In this step you will be mounting the Tire Swing Beam to the fort.

An extra person is needed for this step

- 1: Install t-nuts in the previously drilled holes as shown below.
- 2: Line up the pilot holes at the end of the Tire Swing Beam with the previously drilled holes in the Corner Post.
- 3: Fasten the Tire Swing Beam to the Corner Post using 5/16 x 7-1/2" hex bolts with 5/16" and 1/2" washers through the Tire Swing Beam and Corner Post, into the t-nuts.
- 4: After the Tire Swing Beam has been secured, install the one 5/4 x 3 x 28-1/2" Panel Slat flush to the side of the tire swing beam with 2" wood screws. Install the final Panel Slat in the opening leaving a 3-3/8" space on either side of the slat.

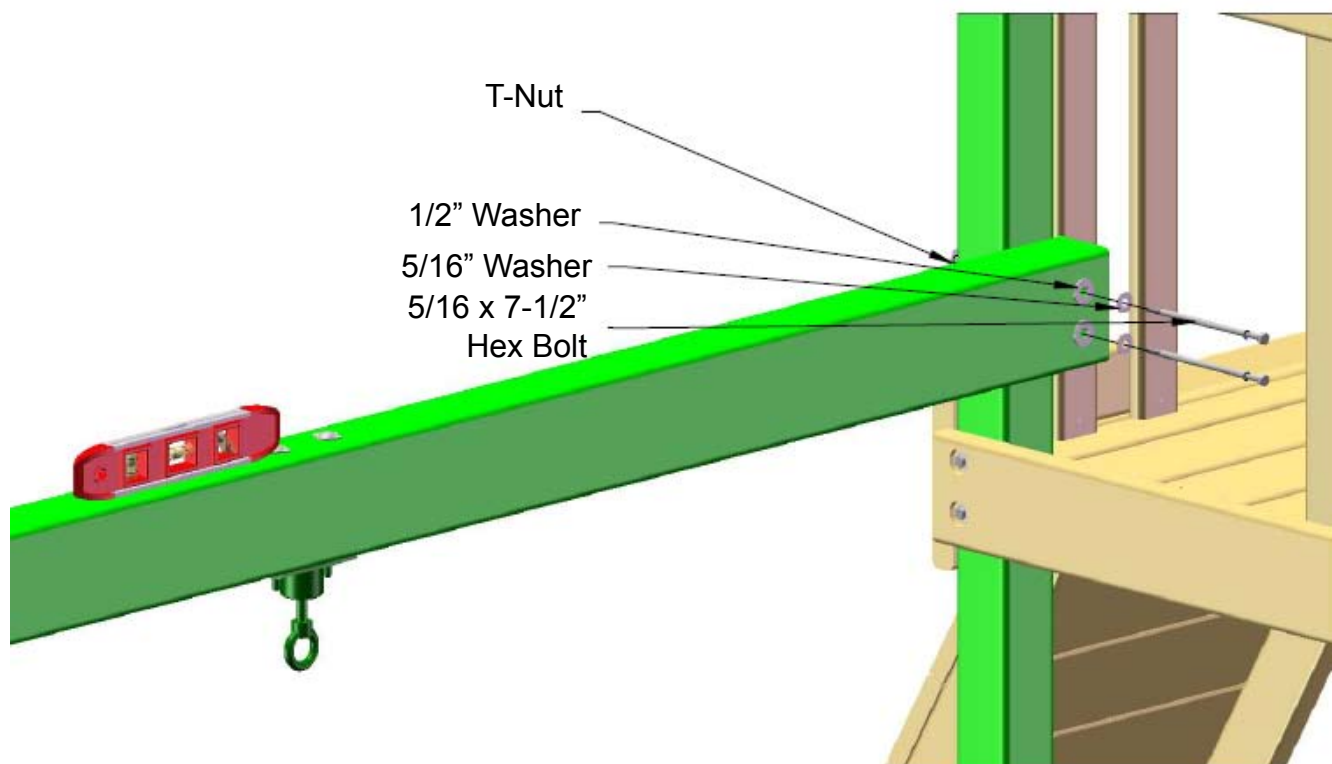

Panel slat removed from view for clarity

Step 47: Level Tire Swing Beam

1: Place a level on top of the Tire Swing Beam and adjust the Tire Swing Legs in or out as needed to make the Tire Swing Beam level.

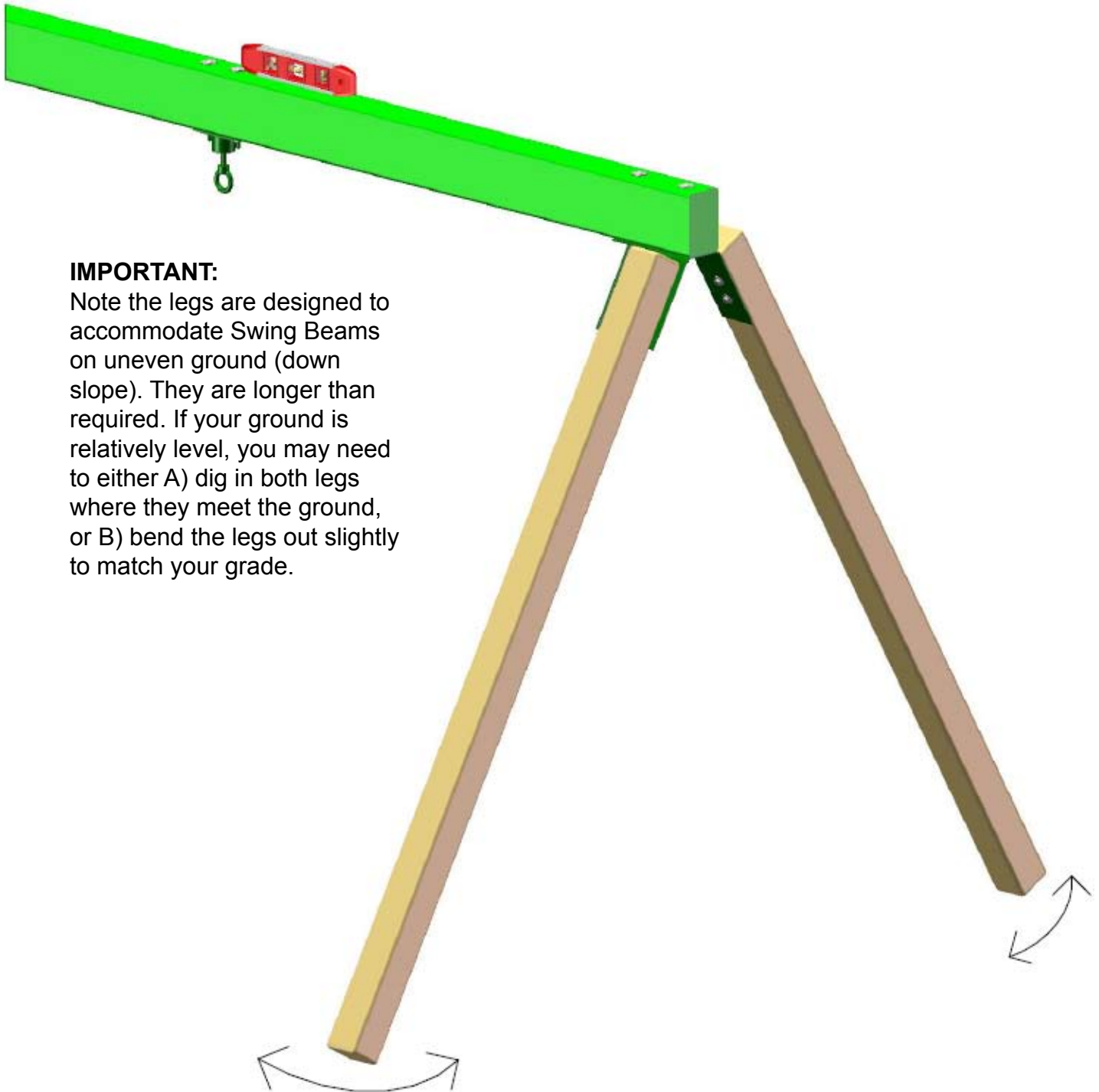

IMPORTANT:

Note the legs are designed to accommodate Swing Beams on uneven ground (down slope). They are longer than required. If your ground is relatively level, you may need to either A) dig in both legs where they meet the ground, or B) bend the legs out slightly to match your grade.

Step 48: Swing Leg Cross-Member

- 1: Position the 2 x 4 x 47-1/2" Tire Swing Cross-Member against the Swing Legs.
- 2: Level the Tire Swing Cross-Member and mark the location of the securing holes inside the cross-member holes onto the Swing Legs.
- 3: Use 3/8 x 3-1/2" lag screws with 3/8" washers to secure the Tire Swing Cross-Member to the Swing Legs.

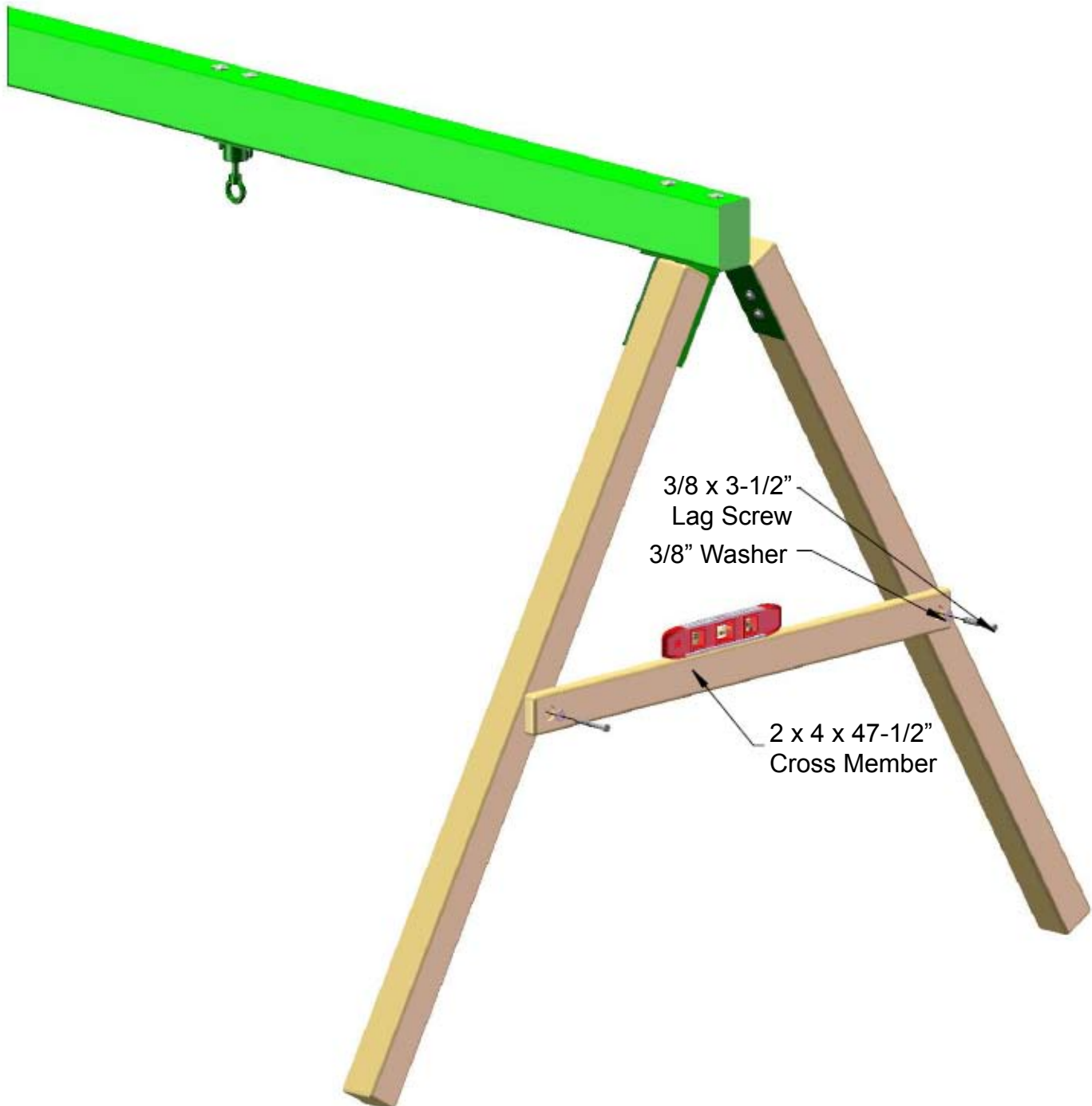

Step 49: Hanging the Tire Swing

- 1: Start by attaching the Spring Clip to the Tire Swivel on the Swing Beam.
- 2: Attach one chain at a time to the Spring Clip.
- 3: Adjust height as needed

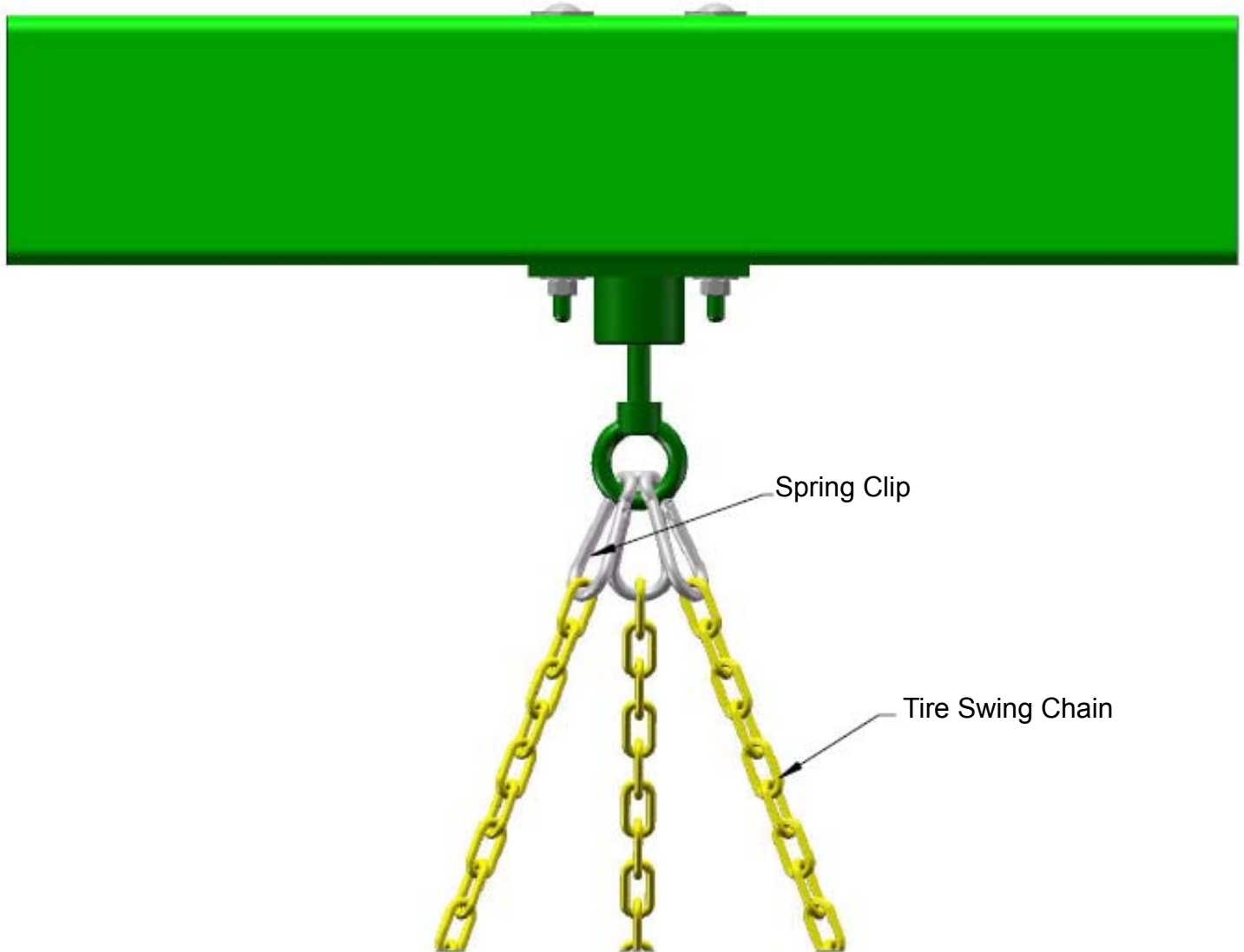

Step 50: Rope Ladder assembly

- 1: Drill three 1/8" pilot holes 2" deep into the bottom of the Rope Ladder Support (see dimensions below).
- 2: Place the eyebolt lag screws into the holes at the bottom of the Rope Ladder Support and tighten.

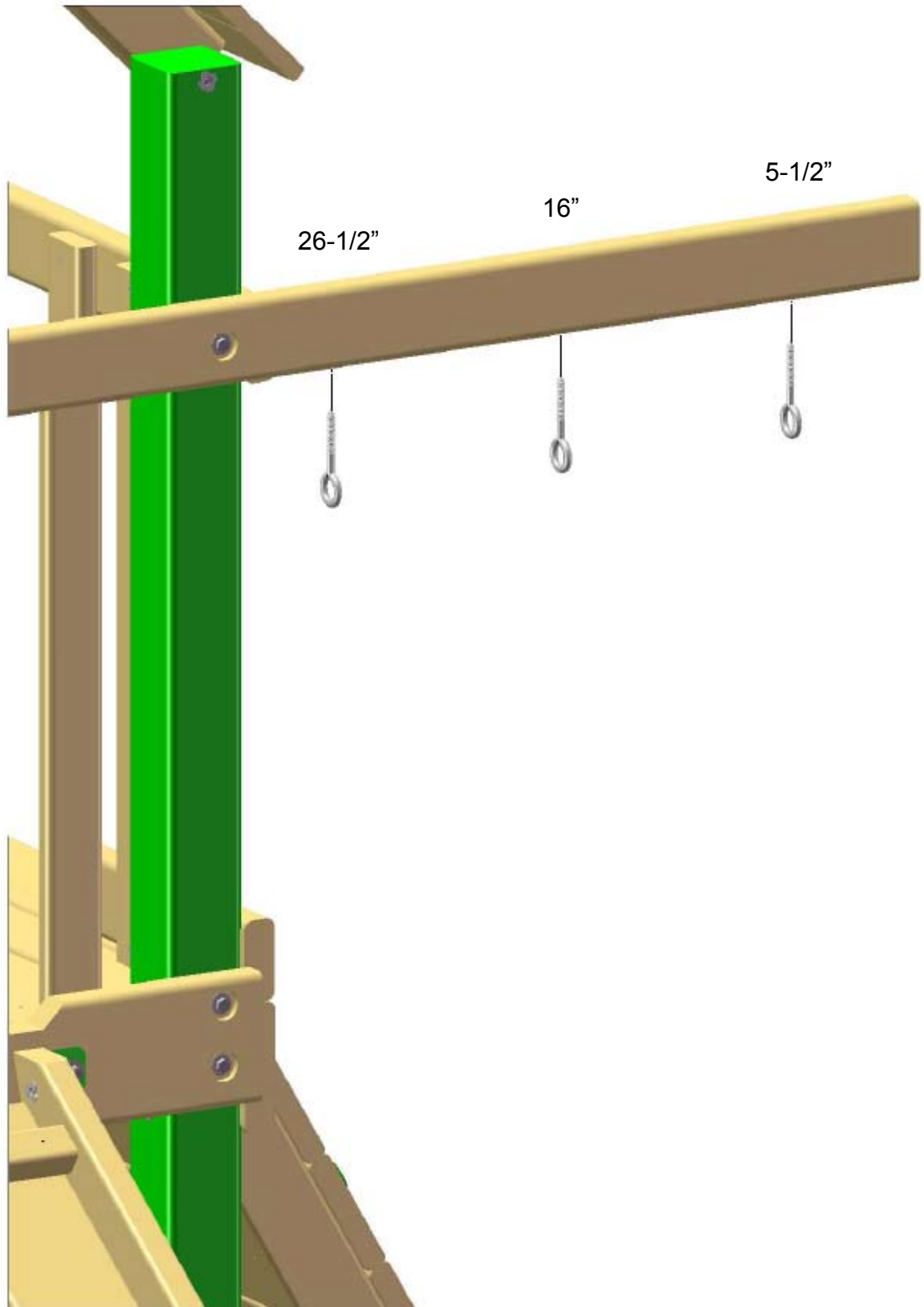

Step 51: Rope Ladder assembly

- 1: Place the hooks on the end of the Rope Ladder Assembly through the eye of the eyebolt lag.
- 2: Thread each rope at the bottom of the Rope Ladder Assembly through the holes in the Rope Ladder Runner and tie a secure knot.

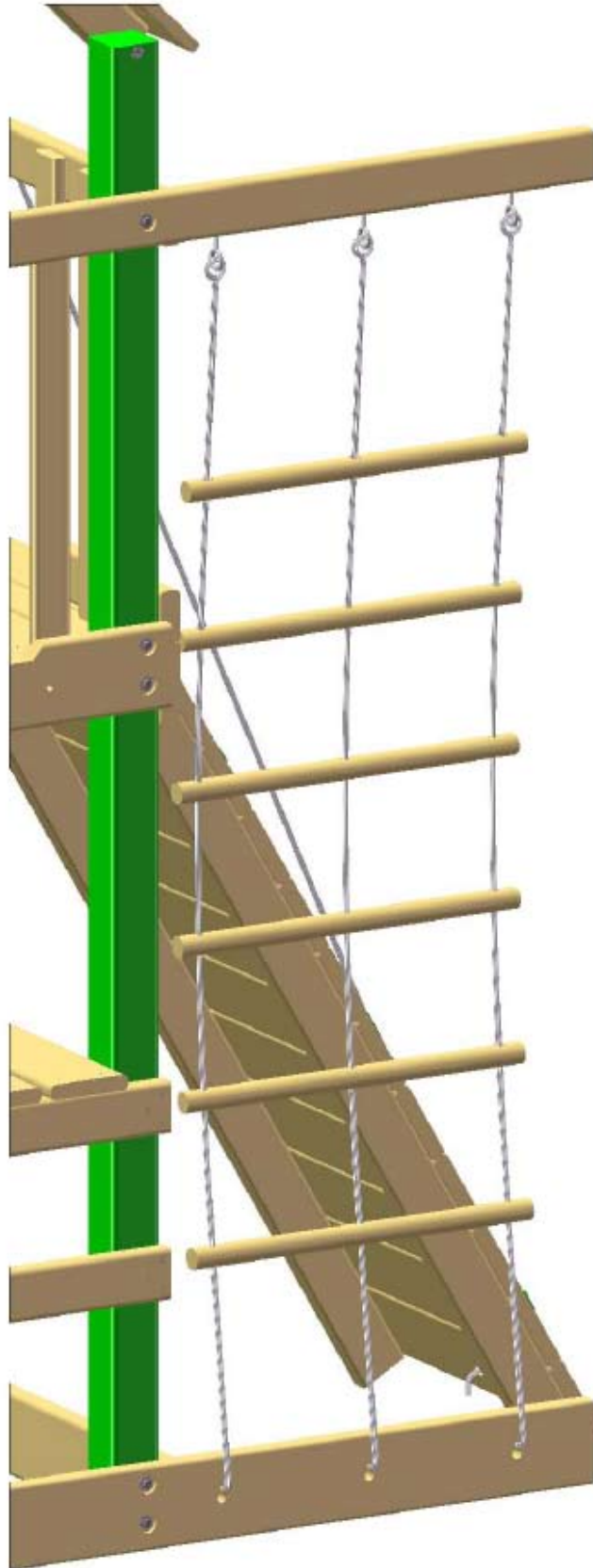

Step 52: Mounting the Slide

- 1: Position the Slide so that it rests flush on the Deck Boards in the front opening.
- 2: Fasten to the fort with 1-1/4" pan head screws. ****DO NOT OVER TIGHTEN****

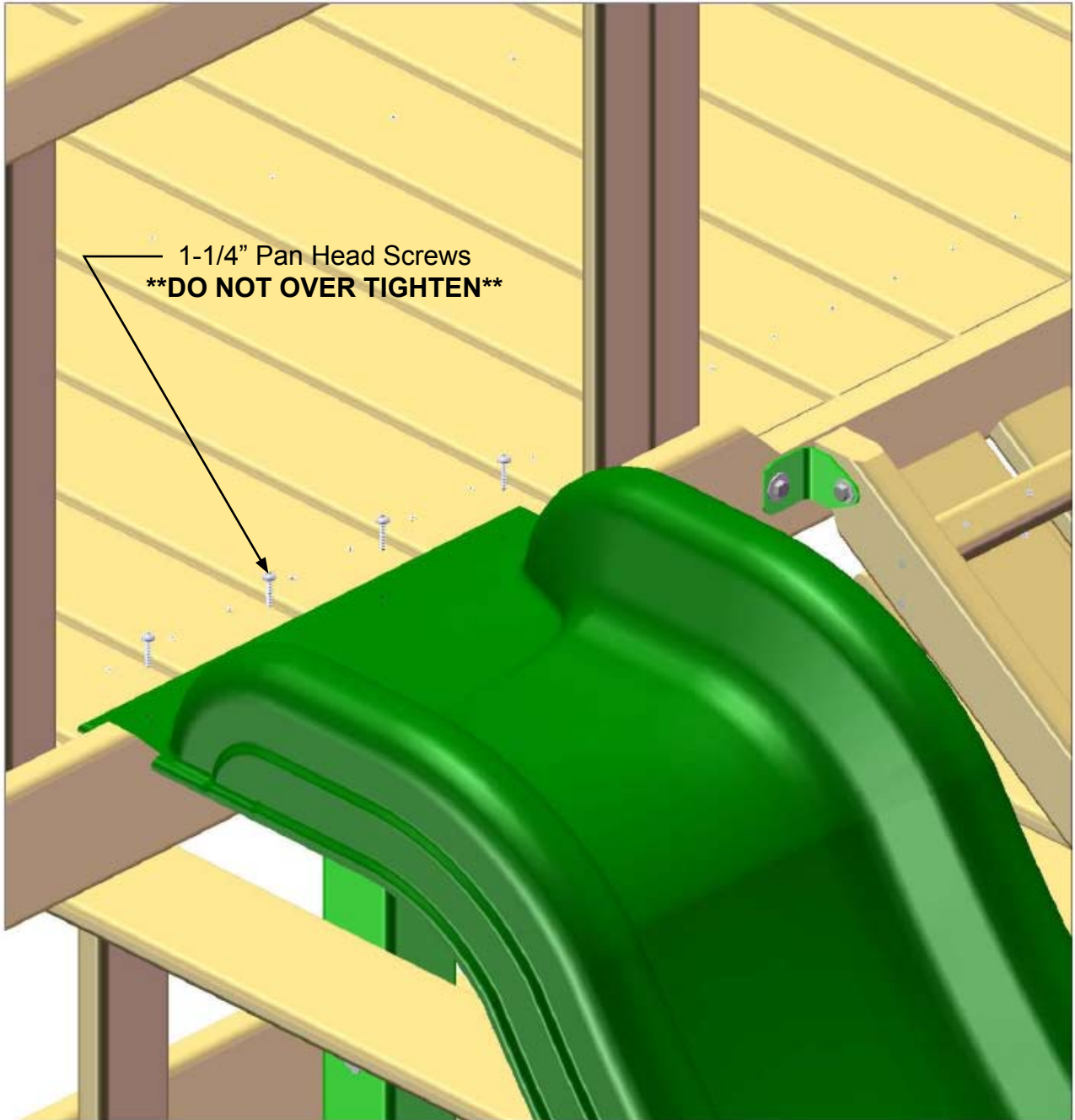

Step 53: Mounting the Telescope

- 1: With the 1-1/4" wood screws provided in the telescope bag, fasten one of the Telescope Brackets onto the Rope Ladder Support above the center Panel Slats.
- 2: Place the Telescope Stand and Telescope into the half circle cutout of the Telescope Bracket.
- 3: Fasten the remaining Telescope Bracket to the opposite side that the first Telescope Bracket was installed on with 1-1/4" wood screws.

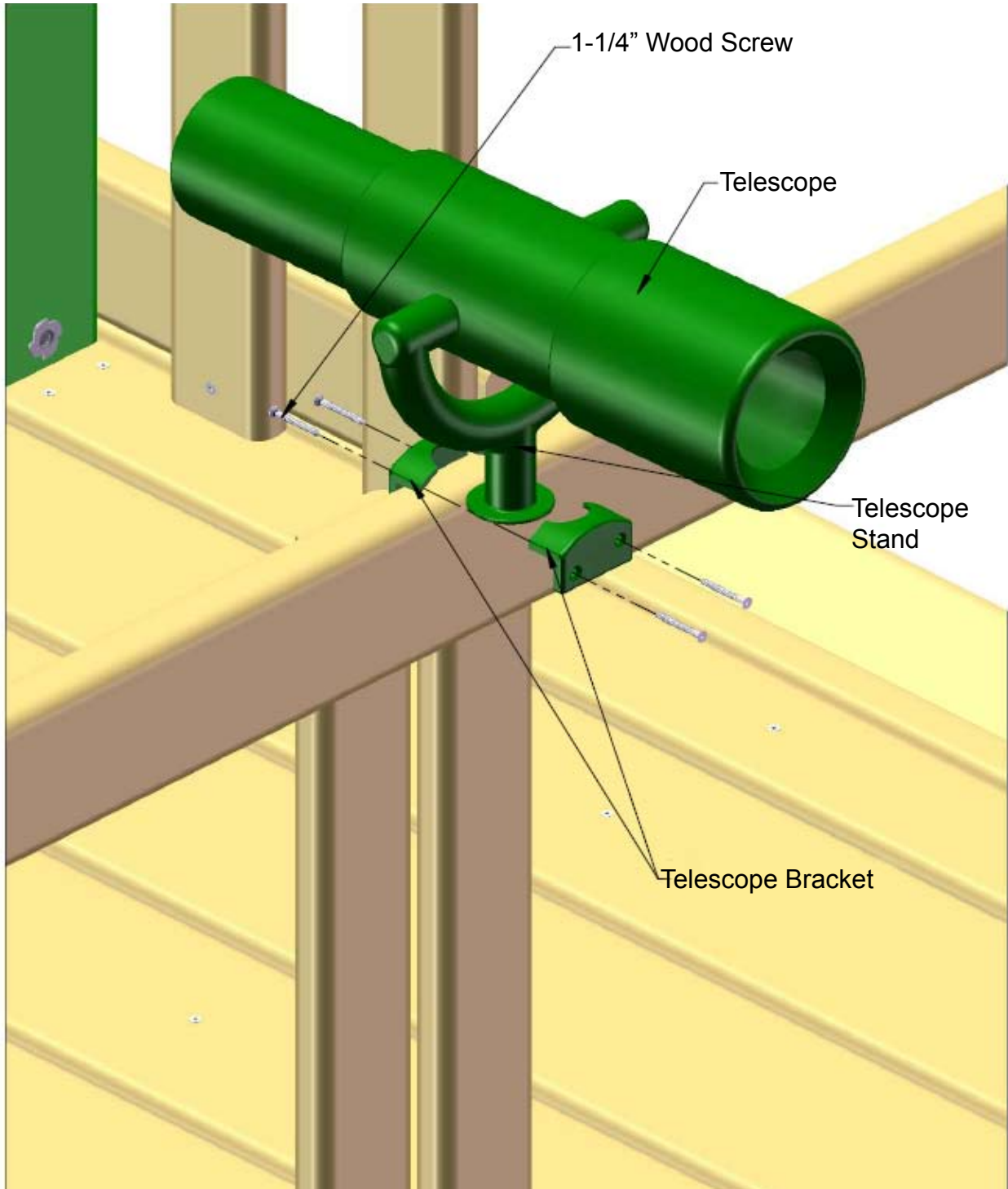

Step 54: Tic- Tac- Toe Panel

1: Assemble the Tic-Tac-Toe Panel according to the instructions in the box.

IGNORE Step 6 & Step 7 in the instructions.

2: Attach the 1-3/8" x 1-5/8" x 10-1/2" Tic-Tac-Toe Boards to the Green Plastic Brackets with the 1" Phillips head screws provided in the Tic-Tac-Toe box. **IMPORTANT:** Make sure the Tic-Tac-Toe Board is mounted to the Green Bracket observing the 1-5/8" dimension shown below).

3: Center the Tic-Tac-Toe Panel between the Panel Slats on the back wall with the bottom Tic-Tac-Toe board spaced 4" above the Deck Boards, and attach with 2" wood screws going through the Panel Slat and then into the Tic-Tac-Toe Board.

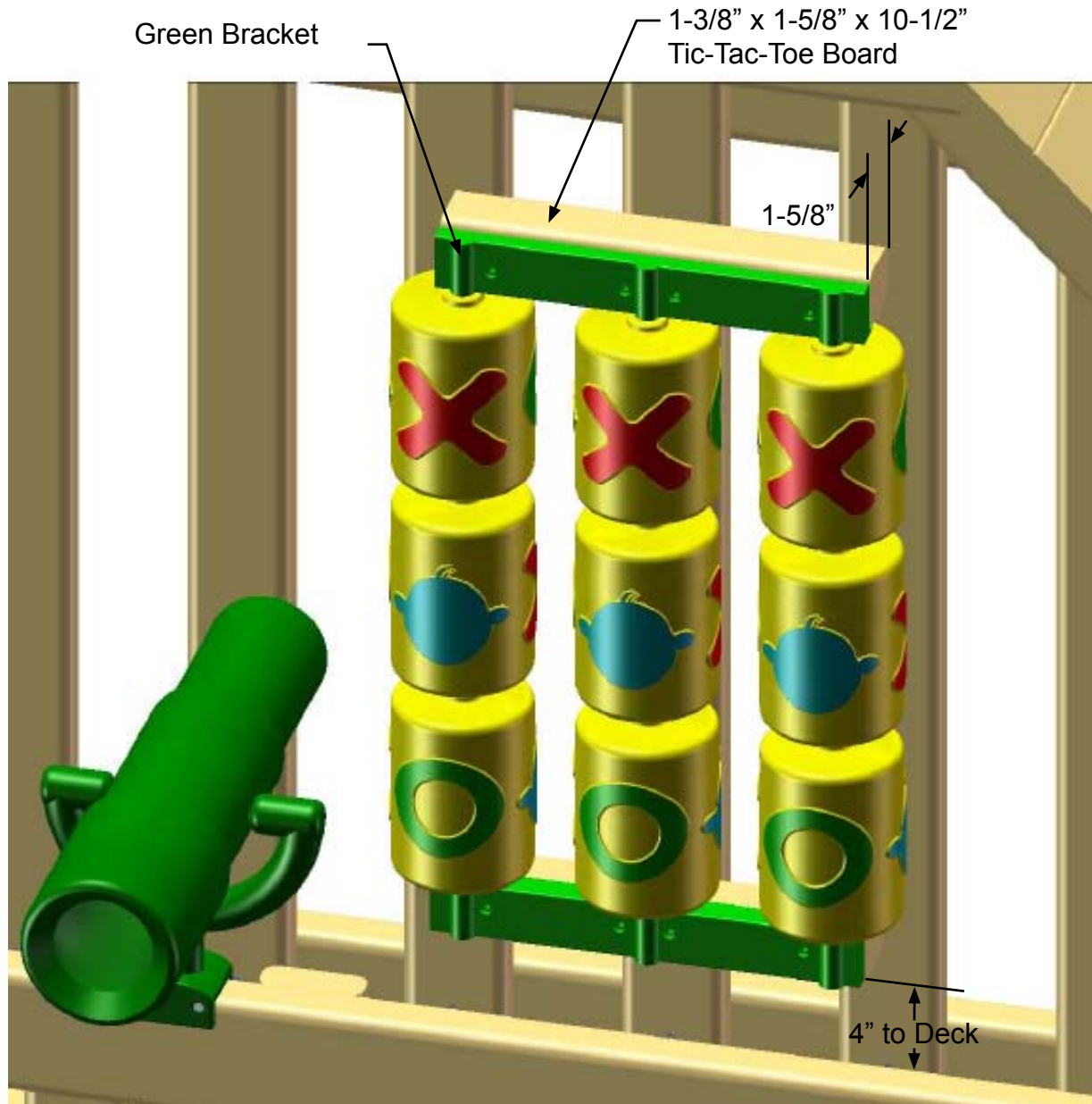

Step 55: Chimney and Dormers

1: Assemble and install the Chimney and Dormers with the directions provided in the box.

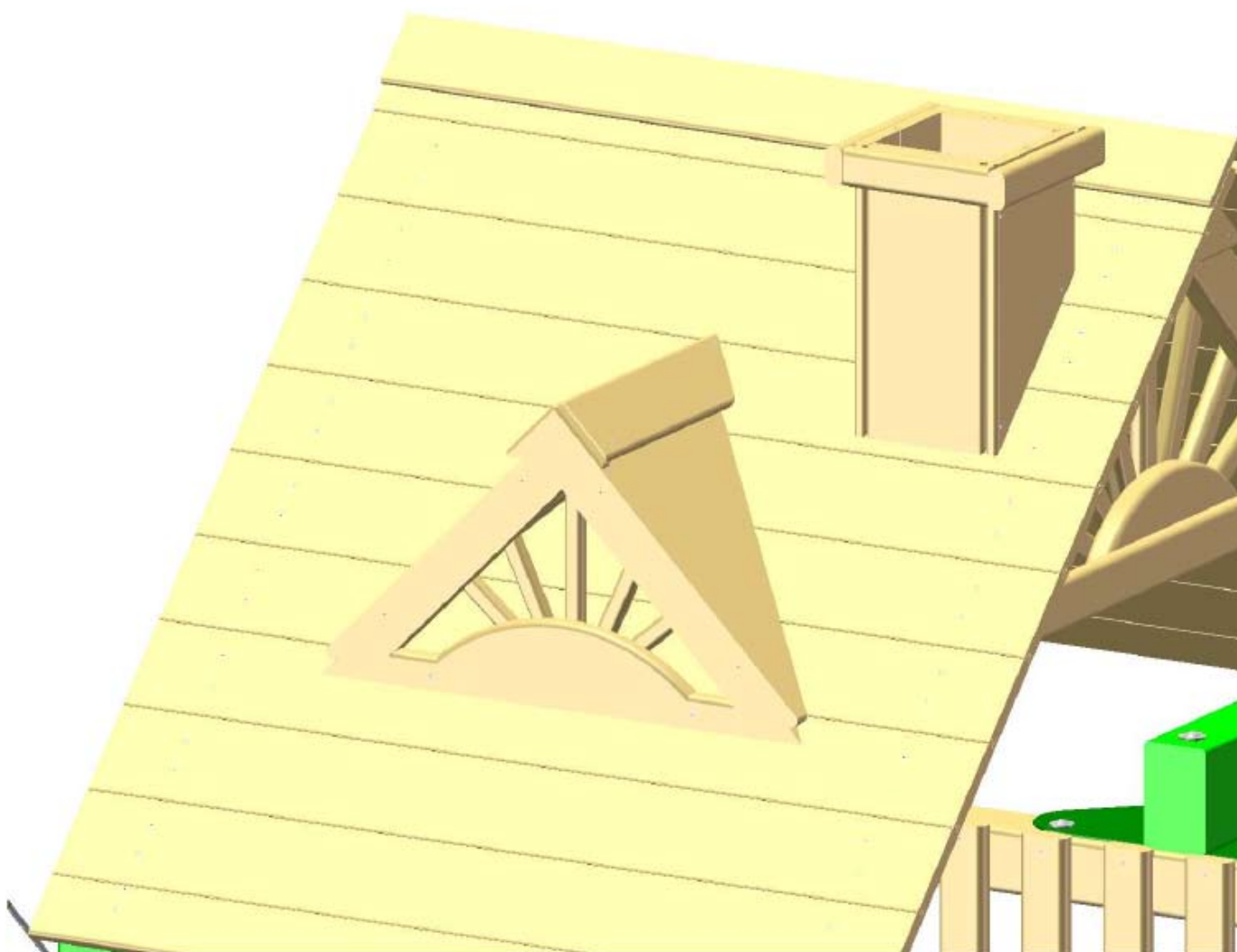

Step 56: Angle Supports

- 1: The four 2 x 4 x 13" Angle Supports are mounted under the deck on the front and back of the fort.
- 2: Use two 2-1/2" wood screws going through the Deck Support into the top of the Angle Support. Use one 2" and one 3" wood screw to fasten the other end of the Angle Support to the Corner Post.
- 3: Repeat the process for the other three Angle Supports on the front and back of the fort.

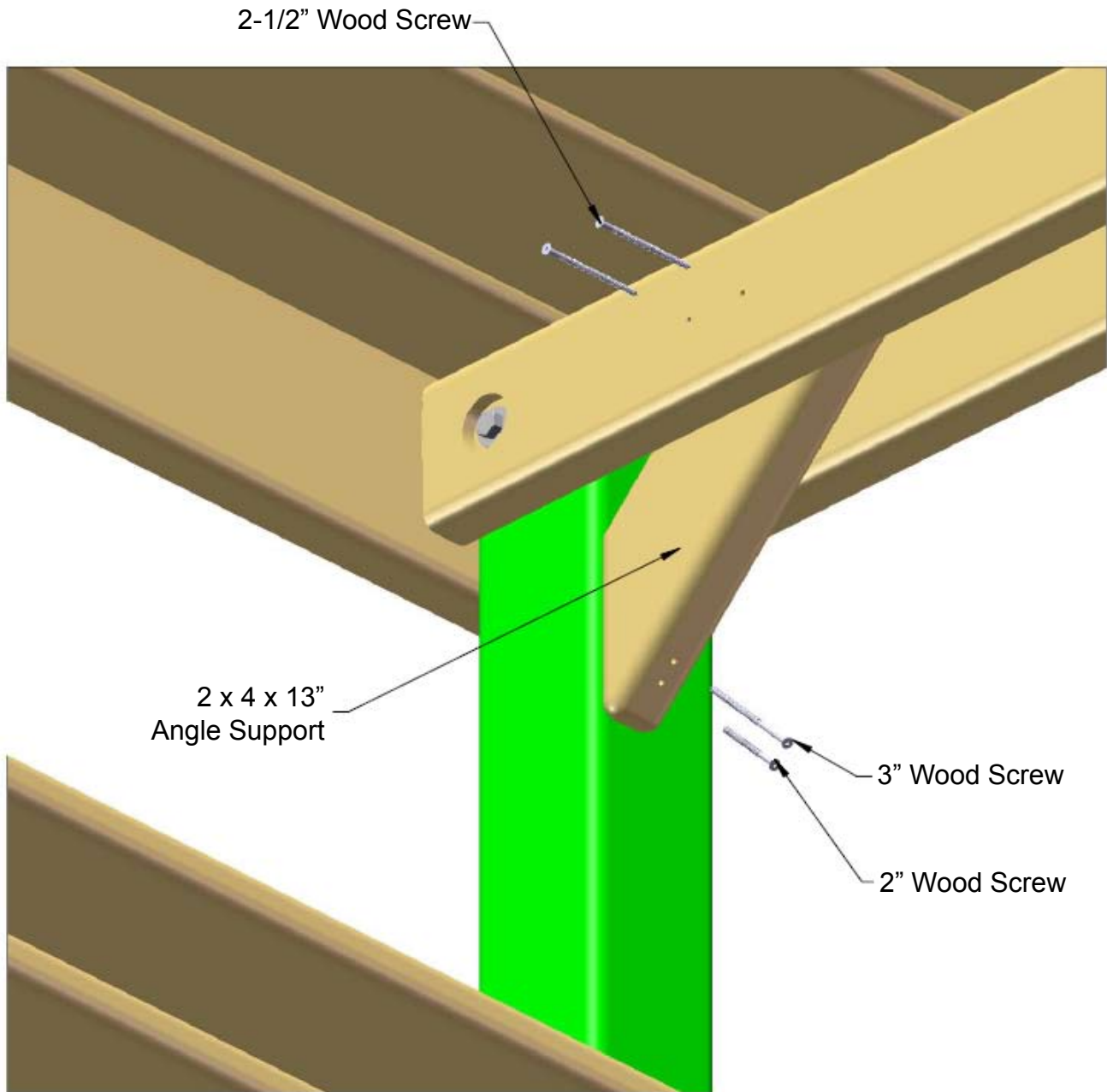

Step 57: Angle Supports

- 1: The four 2 x 4 x 18" Angle Supports are mounted under the deck on the left and right sides of the fort.
- 2: Use two 2-1/2" wood screws going through the top of the Angle Support into the Bottom Panel Board. Use one 2" and one 3" wood screw to fasten the Angle Supports to the Corner Posts.

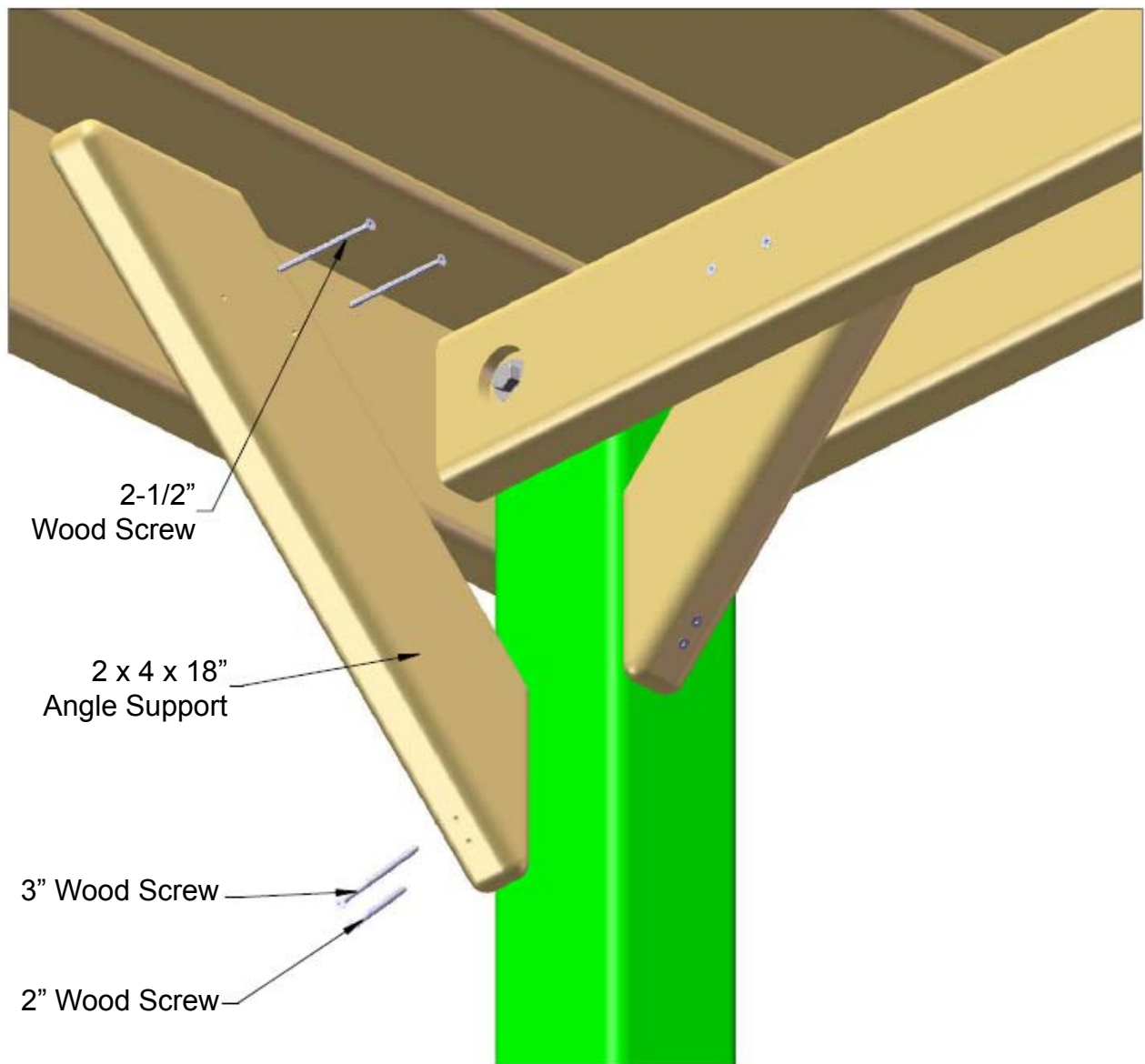

Step 58: Safety Handles

1: Place the Safety Handles on the unit as shown below and attach with the provided hardware.

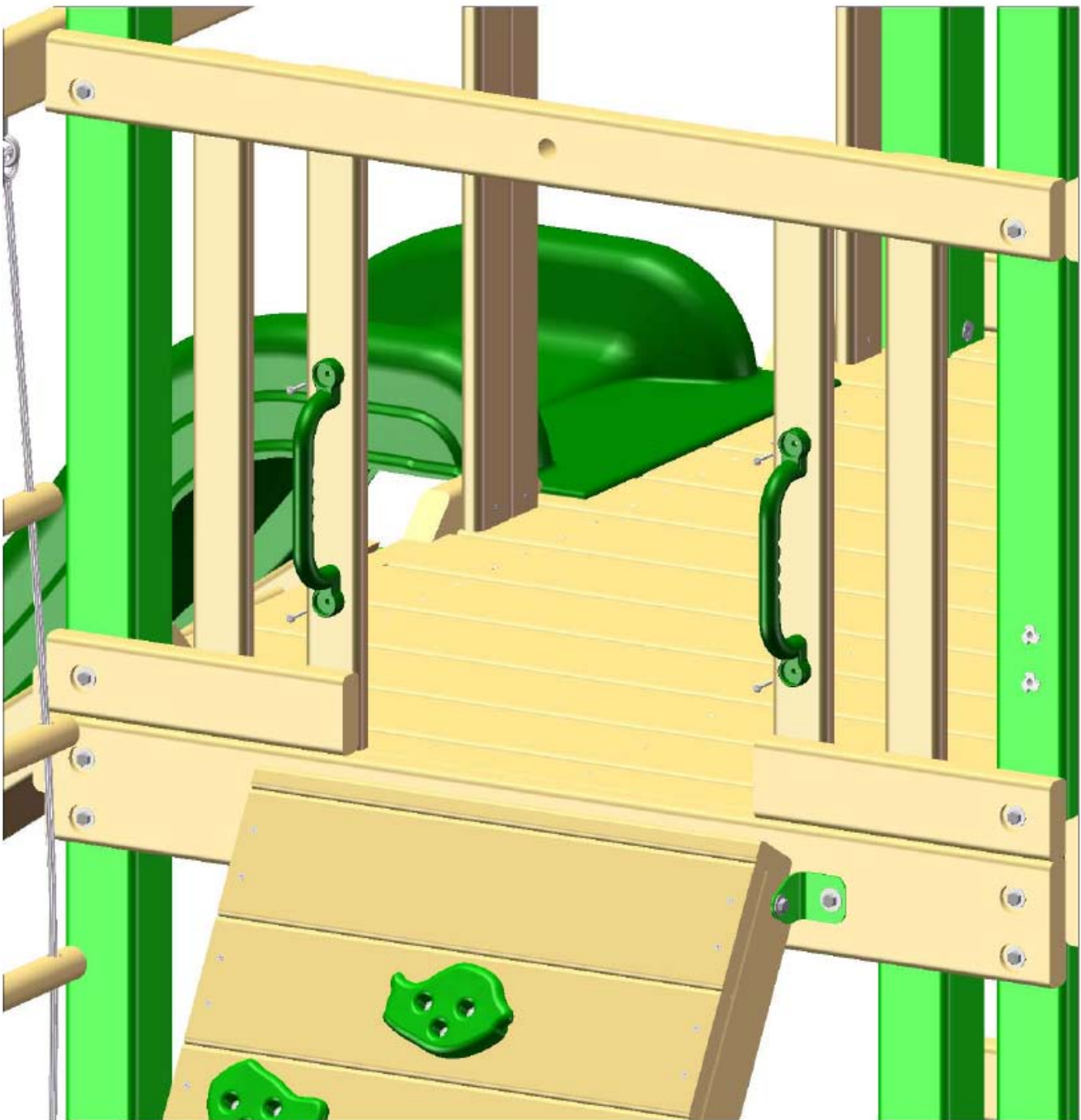

Step 59: Installing Climbing Ropes

1: Tie a knot at one end of the 10' Rope and thread it through the hole in the Top Panel Board above the Rock Wall. (This is the hole you drilled in Step 2.)

2: The untied end will go through the hole of the Bottom Rock Wall Board. If there is a large amount of excess Rope on the Rock Wall, you can tie two or three knots approximately 18 inches apart to aid your child in climbing.

Tie a secure knot at the end making sure that the Rope is tight. Once the knot is tied do a safety check; you should not be able to wrap the Rope around your hand.

Hint: to reduce the amount of slack in the Rope, lift the Rock Wall Assembly slightly when tying the knot behind the Bottom Rock Wall Board. When you lower the assembly, the Rope will tighten.

3: Tie a knot at one end of the other piece of 10' Rope and thread it through the bottom hole of the Climbing Ramp going from the bottom to the top.

4: The untied end will go through the hole at the top of the Climbing Ramp. If there is a large amount of excess Rope on the Climbing Ramp you can tie two knots approximately 2 feet apart on the Climbing Ramp. Tie a secure knot at the end making sure that the rope is tight. Once the knot is tied do a safety check; you should not be able to wrap the rope around your hand.



Step 60: Flag Kits

1: Place the Flag Kit in the desired location on the fort and attach with the hardware provided. The recommended location is on the corner posts at the front of the fort.

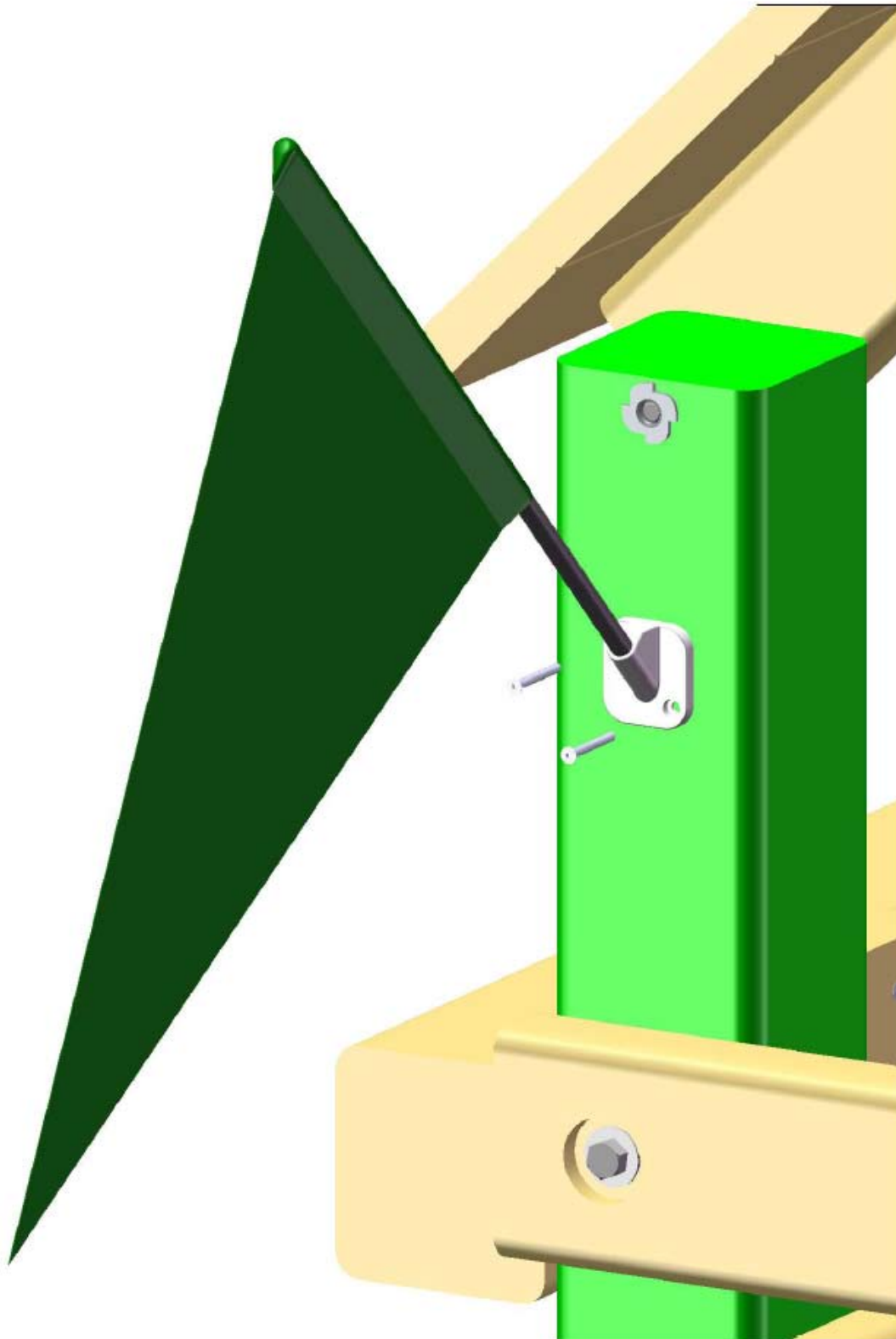

WARRANTY REGISTRATION CARD - Frontier

Go to www.gorillaplaysets.com/category-s/112.htm to fill out our online registration and save a stamp! If you do not have internet access, fill out this form and return it to us to complete your registration.

Name: _____

Address: _____

City, State, Zip: _____

Email: _____

Date of Purchase: _____

Place of Purchase: _____

City, State, Zip: _____

Please, check the boxes below.

Your age?

- 18-25 26-30 31-35 36-40 41-45 46-50 51-55 56-60
 61-65 66+

How old are your children?

- 2-3 4-5 6-7 8+

How would you rate the quality of our product?

- Excellent Above average Average Below average Poor

Would you recommend this product?

- Yes No

Comments:

Thank you for registering with Gorilla Playsets™! The information you provided will be kept confidential and will ONLY be used to better serve our customers. Remove this page from the manual and mail to the address below. Thank you from everyone here at Gorilla Playsets™!

Mail to:

Gorilla Playsets
190 Etowah Industrial Court
Canton, GA 30114
or fax: (678) 880-3329

