

# gorilla

playsets

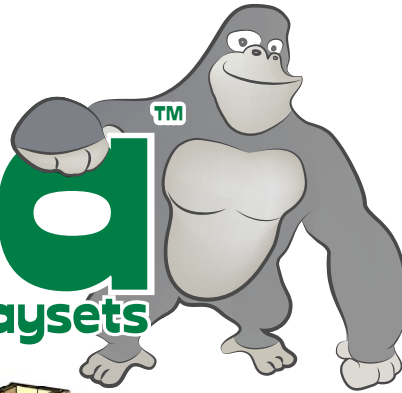

## The Five Star Space Saver

Timber Shield Post Option  
BOXES: 380

**Model: 383**

(BOXES: 380-1, 380-2, 383, 320  
& Slide Box)

Copyright © 2018 Gorilla Playsets  
All Rights Reserved



**51-0094-W**

190 Etowah Industrial Court  
Canton, GA 30114

**[www.gorillaplaysets.com](http://www.gorillaplaysets.com)**



Please inspect and inventory all parts immediately upon accepting delivery. Use the inventory pages in the manual to make sure you have received all necessary parts. The quickest method to get any parts that are missing or damaged is to use our “Quick Response Center” located at:

**[www.gorillaplaysets.com/support](http://www.gorillaplaysets.com/support)**

DO NOT RETURN THIS PRODUCT TO THE RETAILER OR CONTACT THE RETAILER DIRECTLY. THE RETAILER DOES NOT STOCK COMPONENTS.

**PLEASE RETAIN ALL INSTRUCTIONS FOR FUTURE REFERENCE. KEEP THEM IN A SAFE PLACE WHERE YOU CAN REFER TO THEM AS NEEDED. CHECK FOR REVISED INSTRUCTIONS AT:**

**[www.gorillaplaysets.com/manuals](http://www.gorillaplaysets.com/manuals)**

## GORILLA PLAYSETS WARRANTY – 2018

---

Gorilla Playsets® (“Gorilla”) warrants its play sets to be free from defects in workmanship and materials, under normal use and conditions, for 10 years for above ground structural wood components and for one year for all other components (e.g., swings, hardware, plastics, tarps, rope ladder, etc.).

Gorilla warrants all remaining products, including but not limited to its, Malibu Playhouse, Free Standing Swing Set, Free Standing Tire Swing, See-Saw, Children’s Picnic Table with Umbrella, Play-Zee-Bo™, Cedar Toy Chest, Interlocking Sandbox and spring riders to be free from defects in workmanship and materials, under normal use and conditions, for a period of 1 year.

**Cosmetic imperfections and natural tendencies of wood such as peeling, splintering, warping, seasonal checking or cracking, knots or knot holes, etc. are normal characteristics of all outdoor wooden play equipment and are not covered by this warranty. Checks or cracks in wood components that do not affect the intended function of the part, piece or overall swing set are not covered under this warranty.**

Wood rot or decay that develops because the product was installed in an area with poor drainage is not covered under this warranty. Lumber that has been damaged by wood boring bees, or conditions that develop as a result of faulty or improper installation of the product, are not covered by this warranty. Fading of stain, discoloration or mold on any wood part or accessory is not covered by this warranty. Cracks in plastic components, surface rust on hardware and chips on powder coated materials are not considered defects in material as long as they do not affect the functionality or structural integrity of the part or component.

It is the owner’s responsibility to maintain the swing set. **This includes but is not limited to staining and sealing the lumber as needed and regular inspection to be sure all hardware is tight.** Instructions for proper maintenance can be found on Gorilla’s website. Imperfections or conditions that develop because of a failure to properly maintain the swing set are not covered by this warranty.

Gorilla will, at its discretion, replace any above ground part within the stated warranty period that is defective in workmanship or materials. This decision is subject to verification of the defect, which, at Gorilla’s discretion, may be accomplished by submitting photographs or by delivery of the defective part to Gorilla Playsets • 190 Etowah Industrial Ct. • Canton, GA 30114 • 1-800-882-0272 Monday to Friday 9AM-5PM EST. Any warranty claim must include proof of purchase, including the date of purchase. **In addition, within the first 30 days from the date of purchase, Gorilla will replace any parts discovered to be missing from or damaged in the original packaging.**

This warranty is valid only if the product is used for the purpose for which it was designed and installed at a residential, single-family dwelling. This warranty is void if the product is used in a commercial, institutional or multi-family setting. **This warranty does not cover normal wear and tear or (a) products that have been damaged by acts of God and/or nature, negligence, misuse or accident; (b) products that have been modified or repaired by unauthorized persons; (c) the cost of labor; or (d) the cost of shipping any replacement product or part.**

GORILLA DISCLAIMS ALL OTHER REPRESENTATIONS AND WARRANTIES OF ANY KIND, EXPRESSED, IMPLIED, STATUTORY OR OTHERWISE, INCLUDING THE IMPLIED WARRANTIES OF MERCHANTABILITY AND FITNESS FOR A PARTICULAR PURPOSE. GORILLA WILL NOT BE LIABLE FOR ANY INCIDENTAL OR CONSEQUENTIAL DAMAGES. This warranty is non-transferable and does not extend to the owners of the product subsequent to the original purchaser. Some states do not allow limitations on implied warranties or exclusion of incidental or consequential damages, so these restrictions may not be applicable to you. This warranty gives you specific legal rights. You may also have other rights which vary from state to state.

# IMPORTANT SAFETY GUIDELINES

This product is recommended for use by children ages 3-11. This product is intended for residential use only and not intended for use in any public setting. A safety surface such as mulch or recycled tire should be used under the play set to prevent injury from falls. Also a 6 foot safety zone should be used around the entire play set.

As with any home project, good judgment and respect for power tools will greatly reduce the risk of injury. Gorilla recommends you follow all tool manufacturers' safety guidelines. Always wear eye protection and safety gloves to prevent injury. In several phases of construction two people may be required for lifting and securing of lumber. While the play set is being constructed, please keep children off the equipment until the project is complete. Bolts and screw heads should be checked regularly for tightness. The ground ladder, rope ladder, slide, swings and other areas where children spend a majority of their playtime should be checked more frequently.

Gorilla shall not be liable for incidental, indirect or consequential damages or injuries that result from building and/or playing on our play sets. Adult supervision is recommended anytime a play set is being used.

## WEIGHT LIMITS FOR GORILLA PLAYSETS

- FORT PLATFORMS: 800 LBS. TOTAL WEIGHT
- SWING BELT: 225 LBS.
- TANDEM SWINGS: 70 LBS. PER CHILD. UP TO 140 LBS. TOTAL WEIGHT.
- TRAPEZE: 125 LBS.
- FULL BUCKET SWING/ HALF BUCKET SWING: 50 LBS.
- HEAVY DUTY TODDLER BUCKET SWING: 85 LBS.
- INFANT SWING: 35 LBS.
- TIRE SWING: 125 LBS. TOTAL WEIGHT
- ROPE LADDER: 75 LBS.
- ROCK WALL: 150 LBS.
- CLIMBING RAMP: 150 LBS.
- MONKEY BARS: 175 LBS.
- ALL SLIDES: 150 LBS.

Gorilla recommends that the weight limits for all components must not be exceeded. Failure to adhere to these and other safety guidelines could result in damage to the play set and injury to the users.

# PRODUCT REGISTRATION

- THE FIVE STAR SPACE SAVER -

Gorilla Playsets™ manufactures the finest quality products that are designed for outstanding strength and durability. We back our products with unparalleled warranties. In the unlikely event that you need to contact us about covered repairs, we must have a valid Product Registration on file.

3 EASY WAYS TO REGISTER	
<b>OPTION 1</b>	Complete the online registration form at: <b><a href="http://www.gorillaplaysets.com/register">http://www.gorillaplaysets.com/register</a></b>
<b>OPTION 2</b>	Fax this completed form to: <b>(678) 880-3300</b>
<b>OPTION 3</b>	Mail this completed form to: <b>Gorilla Playsets</b> <b>190 Etowah Industrial Court</b> <b>Canton, GA 30114</b>

## Where did you buy this product?

Date of Purchase \_\_\_\_\_ Store \_\_\_\_\_ Store City \_\_\_\_\_ Store State \_\_\_\_\_

## Your registration information:

Name: \_\_\_\_\_ Email: \_\_\_\_\_

Address: \_\_\_\_\_

Street

City

State

Zip

Please select  18-30  41-50  
your age  31-40  51+

How old are  2-3  6-7  
your children?  4-5  8+

Number of   
children

How would  ★ ★ ★ ★ ★ Excellent  
you rate the  ★ ★ ★ ★ Above Average  
quality of this  ★ ★ ★ Average  
product?  ★ ★ Below Average  
 ★ Poor

Would you recommend this product to friends & family?  Yes  No

May we add you to our mailing list?  Yes  No

May we use your comments on websites or other marketing materials?  Yes  No

Comments: \_\_\_\_\_

\_\_\_\_\_  
\_\_\_\_\_  
\_\_\_\_\_

**THIS PAGE INTENTIONALLY LEFT BLANK**

## **IMPORTANT – PLEASE READ**

Congratulations! You have just purchase one of the finest residential wooden swing sets available today. As with any wooden product that spends its entire life outside, in varying elements, it is important to know what to expect with your new swing set so that your family can enjoy it for many years.

As your swing set acclimates to its new environment, natural characteristics of the wood can show in the form of checks, or “cracks” in the lumber. In almost all cases this is normal and it will not affect the structural integrity of your play set and is not covered under warranty.

## **KEEPING YOUR PLAYSET LIKE NEW**

### **MUST DO's**

**The following owner responsibilities are crucial to the safety, integrity and aesthetic appeal of your swing set and may affect the warranty if not adhered to.**

#### **WITHIN 60 DAYS**

- Check and tighten Hex Bolts/T-nuts, Carriage Bolts/Lock-nuts, and Lag Screws within the first 60 days and then twice annually – once before each season and then once during the season.

#### **WITHIN 90 DAYS**

- Apply a **sealant** or **semi-transparent stain with sealant** within the first 90 days of owning the swing set. Our own Stain/sealant is available online here: <http://www.gorillaplaysets.com/Playground-Sealant-p/10-0003.htm>

Oil based stain or water based stain may be used. Should you choose to use other stain we suggest asking the product covering specialists at any number of specialty paint stores or home improvement centers for a product that would work best for your local environment. \*\* TIP – while the set is new, take a small board from the store with you so they can color match the tint of the stain or sealant.

### **SEASONAL REMINDERS**

- If your area experiences regular snowfall, remove your fabric tarp/canopy to avoid stretching, sagging or tearing of the material. Store it inside, folded up, and it will be as good as new when winter is over.
- If your area experiences extremely cold temperatures, remove swing belts and other pliable features to prolong the lifespan of these play activities.

### **OTHER TIPS**

- Spray swing hangers with Pam, Mazola or olive oil to stop squeaking; do not use petroleum based products such as WD-40 or motor oil.
- To repel yellow jackets and wasps, use a cotton ball and dab interior wooden corners underneath the play set deck with a liquid dish soap. Avoid using insecticides.
- To speed up the slide wipe the center of slide with wax paper every 2 - 3 weeks.

For additional safety and maintenance guidelines, please visit our website.



# IMPORTANT DOCUMENTS

## CUSTOMER MUST READ AND RETAIN

Please go to the following links and read important **SAFETY** information prior to using your new play structure.

<http://www.gorillaplaysets.com/Swing-Set-Safety-s/85.htm>

<https://www.gorillaplaysets.com/Maintenance-s/129.htm>

<http://www.gorillaplaysets.com/manuals.html> (Click on your specific model)

<http://www.gorillaplaysets.com/Warranty-s/82.htm>

**NOTE:** Your children's safety is our #1 concern. Observing the following statements and warnings reduces the likelihood of serious injury. Please review these safety rules regularly with your children.

### **WARNING:**

***Children must NOT use this play set until it has been completely assembled and inspected by an adult to ensure it has been properly installed.***

Gorilla Playsets  
190 Etowah Industrial Court  
Canton, GA. 30114





Timber Shield Post Option  
BOXES: 380

**Model: 383**

(BOXES: 380-1, 380-2, 383, 320  
& SLIDE BOX)

REV: 6.14.2018

# TABLE OF CONTENTS

Safety Guidelines.....	Pages 3-6
Leveling Fort, General Information and Definitions.....	Pages 6-8
How to install T-nuts, Board Identification, Predrill Lag Screw Directions and Swing Beam Loading.....	Pages 9-13
Site Plan, Required Tool and Material List, Kit Contents.....	Pages 14-15
Hardware, Lumber and Accessory Checklists.....	Pages 16-31
Adding T-Nuts to Corner Posts and Framing Left/Right Sides.....	Steps 1-4
Framing Fort.....	Steps 5-7
Attaching Deck Spacers and Angle Supports.....	Steps 8-9
Lag Screws.....	Step 10
Inground Mounts.....	Steps 11-14
Deck Stringer, Rock Wall and Ladder.....	Steps 15-25
Deck Boards, Panel Boards and Panel Slats.....	Steps 16-28
Center Post and Swing Beam.....	Steps 29-31
Roof Assembly.....	Steps 32-37
Window Supports/Windows.....	Step 38
Safety Boards.....	Step 39
Slide.....	Step 40
Attaching Accessories.....	Steps 41-47
Appendix: Chimney and Dormer instructions.....	Page 80

**PLEASE READ OWNER'S MANUAL CAREFULLY  
BEFORE STARTING ASSEMBLY!**

## **Safety and Maintenance Tips for Your New Play Set:**

**NOTE: Your children's safety is our #1 concern. Observing the following statements and warnings reduces the likelihood of serious or fatal injury. Please review these safety rules regularly with your children.**

- This play set is designed for the use of 4 occupants who have a combined weight not exceeding 800 pounds on the elevated floor, 2 occupants who have a combined weight of 275 pounds on the swing area, for a total Unit capacity of 6 occupants who have a combined weight of 1075. (This weight does not include any picnic table area(s).)
- On-site adult supervision is required.
- Teach children not to walk close to, in front of, behind, or between moving swings or other moving playground equipment.
- Teach children to sit in and never stand on swings
- Teach children not to twist the chains and ropes and not to loop them over the swing beam, since this may reduce the strength of the chain or rope.
- Teach children not to jump from swings or other playground equipment in motion.
- Teach children not to push empty seats. The seat may hit them and cause serious injury.
- Teach children to sit in the center of the swings with their full weight on the seats.
- Teach children not to use the equipment in a manner other than intended.
- Teach children to always go down slides feet first. Never slide headfirst.
- Teach children to look before they slide to make sure no one is at the bottom.
- Teach children to never run up a slide, as this increases their chances of falling.
- The parents should have the children dress appropriately with well-fitting shoes. Loose clothing such as scarves and ponchos should not be worn. Always take off, tie up or tuck in cords and drawstrings on children's clothing. These things can get caught on playground equipment and strangle a child.
- Teach children not to climb when the equipment is wet.
- Teach children to never jump from a fort deck. They should always use the ladder, ramp or slide.
- Teach children to never crawl or walk across the top of monkey bars or swing beam.
- Teach children to never crawl on top of a fort roof or on the outside of a tube slide.
- Verify that any suspended climbing ropes, chains, or cables are secured at both ends and that they cannot be looped around an adult hand.
- Teach children not to attach items to the playground equipment that are not specifically designed for use with the equipment, such as, but not limited to, jump ropes, clothesline, pet leashes, cables and chain as they may cause a strangulation hazard.
- Teach children to never wrap their legs around swing chain.
- Teach children to never slide down the swing chain.
- Teach children to remove their bike or other sports helmet before playing on the playground equipment.
- Teach children to NEVER look at the sun or other bright light through any accessory such as but not limited to a telescope, periscope or binoculars.

**WARNING: Children must NOT use this play set until it has been completely assembled and inspected by an adult to insure it has been properly installed and anchored.**

# **Safety and Maintenance Tips for Your New Play Set: (continued)**

Playgrounds should be inspected on a regular basis. If any of the following conditions are noted, they should be removed, corrected, or repaired immediately to prevent injuries.

- Hardware that is loose, worn or that has protrusions or projections.
- Exposed equipment footings.
- Scattered debris, litter, rocks, or tree roots.
- Splinters, large cracks, and decayed wood components.
- Deterioration and corrosion on structural components, which connect to the ground.
- Missing or damaged equipment components, such as handholds, guardrails, swing seats.
- Check all nuts and bolts twice monthly during the usage season and tighten as required. (But not so tight that you crack the wood) We recommend you check the swing beam and hardware often due to wood expansion and contraction. It is particularly important that this procedure be followed at the beginning of each season.
- Remove plastic swing seats and take indoors or do not use when the temperature drops below 32°F. Reinstall swings and other swing equipment at the beginning of the usage season.
- Oil all metallic moving parts monthly during the usage period.
- Check all coverings for bolts and sharp edges twice monthly during usage season to be certain they are in place. Replace when necessary. It is especially important to do this at the beginning of each new season.
- Check swing seats, ropes, cables and chains monthly during usage season for evidence of deterioration. Replacement should be made of any swing seat that has developed cracks in the plastic seats. Ropes, cables and chains should be removed and replaced if excessive wear is found. Contact us for warranted replacement parts.
- Swing chains, rings, ropes, etcetera should always be fastened to a rotating swing hanger. NEVER attach a chain, ring, rope, etcetera to a stationary hanger such as but not limited to an eye bolt. Severe wear could occur leading to an injury.
- For rusted areas on metallic members such as monkey bars, hand supports brackets, etc.; sand and repaint, using a non lead-based paint meeting the requirements of Title 16 C.F.R. Part 1303. These requirements are available at: <http://www.cpsc.gov/>
- Inspect wood parts monthly. The grain of the wood sometimes will lift in the dry season causing splinters to appear. Light sanding may be necessary to maintain a safe playing environment. If you are treating your play set with stain regularly, it will help prevent severe checking/splitting and other weather damage.
- Once or twice a year, depending on your climate conditions, you must apply some type of protection (sealant) to the wood of your unit. Prior to the application of sealant, lightly sand any “rough” spots on your set. Please note this is a requirement of your warranty.
- Creating and maintaining the play set on a level location is very important. As your children play, your play set will slowly dig its way into the soil, and it is very important that it settles evenly. Make sure the play set is level and true once each year or at the beginning of each play season.
- Twice a month during the usage season rake the playground protective surfacing materials to prevent compaction and maintain appropriate depths. Replace the protective surfacing materials as required.
- Disposal Instructions: When the play set is no longer desired, it should be disassembled and disposed of in such away that no unreasonable hazards will exist at the time the play set is discarded.

# Play Set Surfacing Recommendations:

Below are some of the recommendations that the U.S. Consumer Product Safety Commission (CPSC) offers from its Handbook for Public Playground Safety. The guide can be downloaded in full at [www.cpsc.gov/PageFiles/122149/325.pdf](http://www.cpsc.gov/PageFiles/122149/325.pdf)

**1. Protective Surfacing** - Since almost 60% of all injuries are caused by falls to the ground, protective surfacing under and around all playground equipment is the most critical safety factor on playgrounds.

Certain manufactured synthetic surfaces also are acceptable; however, test data on shock absorbing performance should be requested from the manufacturer.

Asphalt and concrete are unacceptable. They do not have any shock absorbing properties. Similarly, grass and turf should not be used. Their ability to absorb shock during a fall can be reduced considerably through wear and environmental conditions.

Certain loose-fill surfacing materials are acceptable. Surfacing materials are acceptable, such as the types and depths shown in the table.

## Fall Heights and Materials

Type Of Material	6 in. depth	9 in. depth	12 in. depth
Double-Shredded bark mulch	6' Fall Height	10' Fall Height	11' Fall Height
Wood Chips	6' Fall Height	7' Fall Height	12' Fall Height
Fine Sand	5' Fall Height	5' Fall Height	9' Fall Height
Shredded Tires*	10-12' Fall Height	N/A	N/A
Fine Gravel	6' Fall Height	7' Fall Height	10' Fall Height

\*This data is from tests conducted by independent testing laboratories on a 6-inch depth of uncompressed shredded tire samples produced by four manufacturers. The tests reported critical heights, which varied from 10 feet to greater than 12 feet. It is recommended that persons seeking to install shredded tires as a protective surface request test data from the supplier showing the critical height of the material when it was tested in accordance with ASTM F1292.

*It should be recognized that all injuries due to falls cannot be prevented no matter what surfacing material is used.*

**2. Fall Zones** - A fall zone, covered with a protective surfacing material, is essential under and around equipment where a child might fall. This area should be free of other equipment and obstacles onto which a child might fall. Stationary climbing equipment and slides should have a fall zone extending a Minimum of 6' in all directions from the perimeter of the equipment.

Swings should have a fall zone extending a minimum of 6' from the outer edge of the support structure on each side. The fall zone in front and back of the swing should extend out a minimum distance of twice the height of the swing as measured from the ground to the top of the swing support structure.

## LEVELING YOUR FORT DURING ASSEMBLY

- Complete the steps which will be the basic frame of the fort. {i.e. four corner posts with base (sand box boards) and deck supports}
- Position in the most level area chosen for the play set, keeping in mind the location and size of the swing beam, ladder, slides, etc. that extend off the fort.
- Once the frame is in the final position, check for vertical and horizontal levelness to determine which side(s) will need to be dug into the ground to level the play set.
- With a shovel, score the ground around the outside edges of the sandbox boards on the 'high' side of the fort. This is the area that will be dug in. Make sure to score deep enough; the scored lines will be your digging template.
- Push the frame off and away from the scored area, far enough to dig and remove dirt to reach the appropriate depth.
- Dig a channel along the scored line(s) for the base of the fort (corner post and sandbox boards) to rest into. Dig the channel(s) to the same level depth. The bottom of the channel(s) should be level to each other so your frame doesn't teeter or rock because the channel(s) are uneven.
- Once you have removed enough grass and dirt, slide/push the frame into the channel(s). Place a level on the vertical and horizontal boards of the frame to determine if enough soil, or too much, was removed.
- Repeat this process until the basic frame is plumb and level and in its final position before completing the rest of the assembly.
- Measure to make sure fort is square.

**Important: if you require a channel depth of more than 6", then we recommend you have your play set area professionally graded before completing assembly.**

*Example Play area:*

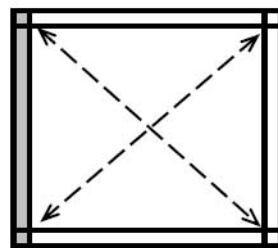

The diagonal measurements should be the same from corner post to corner post. If not, adjust corner posts so that the distance is equal.

■ = Area to be scored and channeled for levelness

# General Info to Review Before Installation

- Depending on your experience, assembly of the playset can take as little as 6 hours up to 24 hours, depending on size, after inventory of parts; therefore, we recommend you set aside a full two days for assembly.
- Identify all of the parts for your play set. Empty each box and lay out boards so you can see each part. Your instruction book will have detailed drawings that will make it easy for you to recognize individual parts. Keep all hardware and metal parts separate from wooden pieces.
- After everything is laid out, check carefully to ensure all parts are present. Make sure there are no broken boards.
- Find an area to sort your hardware. It is best to open the hardware on a solid surface so that you do not lose any pieces in the grass. This will save time and familiarize you with all the different pieces in the hardware bag.
- Important note: Wood has some natural defects such as knots, surface cracks, etc... We reject parts that are structurally defective. We use a high quality lumber in our structures; however, you should inspect each part for splinters or rough spots and sand them smooth to prevent injury.
- After familiarizing yourself with all of the components, read all instructions thoroughly. Reading instructions after you have studied the parts will help you understand the installation process, and help to eliminate unnecessary mistakes.
- Pay close attention to the diameter and length of each bolt and screw.
- Never tighten hardware completely at first. It helps to have some adjustment for bolt alignment while you are attaching parts together. After everything is square, tighten each joint.
- After the main unit is assembled it is critical that the floor is level and square. If the main frame is not level, the walls and floor will be out of square.
- After you complete installation, make sure every bolt, screw, and nut is tight, and every board is secure. Wood will expand and contract with the seasons.
- Place the set on level ground, not less than 6 feet from any structure or obstruction such as a fence, garage, house, overhanging branches, laundry lines, or electrical wires.

**This page is a list of definitions and explanations used throughout our instructions to aid you in the assembly of your play set.**

**Offset Holes-** Throughout the installation procedures we will refer to parts with offset holes. This refers to the orientation of the holes on the board. An offset hole is one that is closer to one side than it is the other or in other words, it is not centered on the board. In the procedures you will be instructed to attach the boards with the holes offset up or with the holes offset down. This refers to which side of the board the hole/holes should be closer to. Offset holes up= hole/holes will be closer to the top of the board. Offset holes down= hole/holes will be closer to the bottom of the board. Note: some parts do not have offset holes, but instead the holes are on center. Therefore there will not be any reference on how to offset these parts.

**EXAMPLE OF OFFSET HOLES UP**

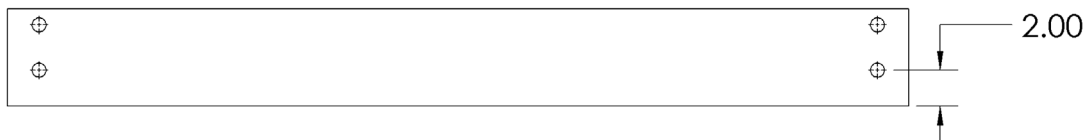

**EXAMPLE OF OFFSET HOLES DOWN**



**Counter-sunk holes** - Many of the parts that will be used have counter-sunk holes. A counter-sunk hole is one that surrounds one side of a through hole, but does not extend through the wood it's self. When using a counter-sunk hole the bolt will be inserted through the through hole and either the head of the bolt and washer or nut and washer will occupy the counter sunk hole.

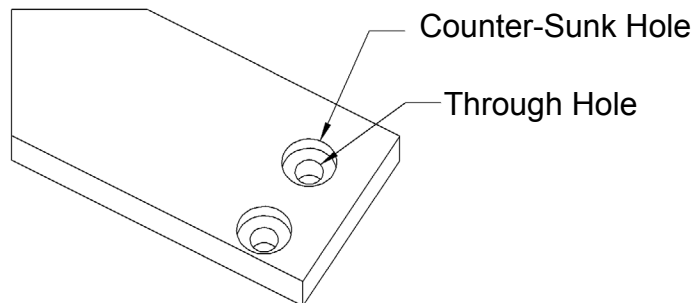

**Lag Screws-** Lag screws are used in the construction of our play sets to enhance the structural integrity of the unit. There will not be predrilled holes in the post for lag screw installation. Lag screws are self-tapping, though if you are using a manual socket wrench it may be advantageous to pre-drill a hole first. Instructions for this are provided on a separate page in the front of the manual. Be sure to tighten the lags completely when driving them in by hand. Power tools such as a heavy duty impact driver or large power drill should have enough torque to drive in the lag screws, but make sure not to over tighten as this can cause the threads to “strip out” in the post.



## Common Installation Practice Installing T-nuts

When installing T-nuts into the wood, use a smooth faced hammer to set the face of the T-nut flush into the wood.

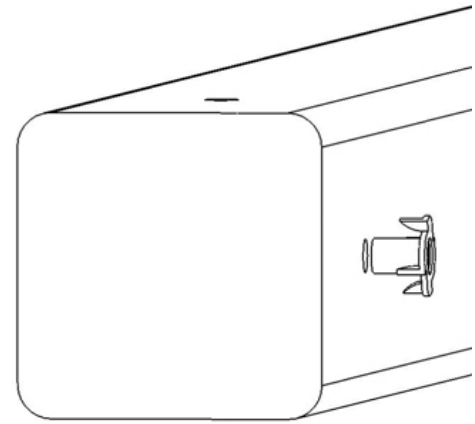
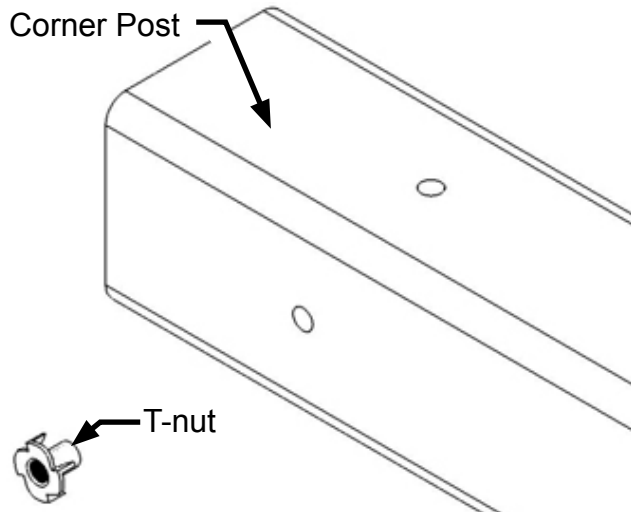

Insert the barrel of the T-nut into the predrilled hole. Using a smooth faced hammer, drive the T-nut until the face of the T-nut is flush to the wood.

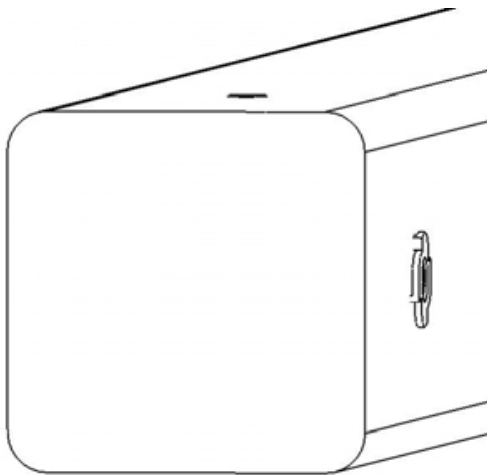

This picture shows the T-nut inserted and installed flush to the wood.

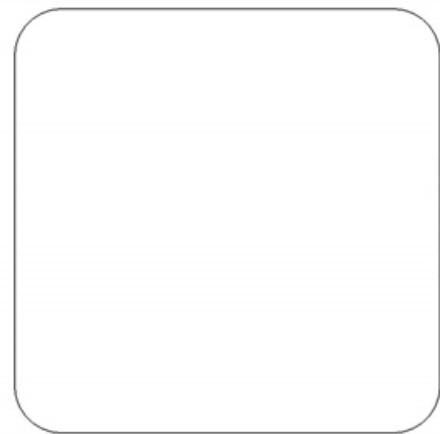

This picture shows an end view of the T-nut installed flush to the wood.

**WARNING: DO NOT EMBED THE TOP OF THE T-NUT INTO THE FACE OF THE WOOD**



Cross Section end view, you are looking at an X-ray view of the post and T-nut. The barrel of the T-nut is in the corner post the line is the face of the wood.

# HOW A T-NUT WORKS

THE FIRST STEP IN OUR ASSEMBLY INSTRUCTIONS IS TO INSERT T-NUTS INTO THE CORNER POSTS. A T-NUT IS A FASTENER WHICH IS THREADED ON THE INSIDE AND IT FUNCTIONS JUST LIKE A STANDARD HEX NUT. YOU INSERT THE T-NUTS INTO THE PREDRILLED HOLES IN THE CORNER POSTS.

THE T-NUT HAS A BARREL SHAPED END WHICH GOES INTO THE HOLE IN THE CORNER POST. THE T-NUT ALSO HAS AN FLANGE SHAPED END WITH TEETH. THE TEETH PENETRATE INTO THE CORNER POST WOOD TO PREVENT THE T-NUT FROM SPINNING WHEN YOU TIGHTEN THE HEX HEAD BOLT.

SHOWN BELOW YOU WILL SEE THE T-NUT IS HAMMERED INTO THE CORNER POST ON THE BACK SIDE. THE BOARD IS BEING ATTACHED ON THE FRONT SIDE OF THE CORNER POST.

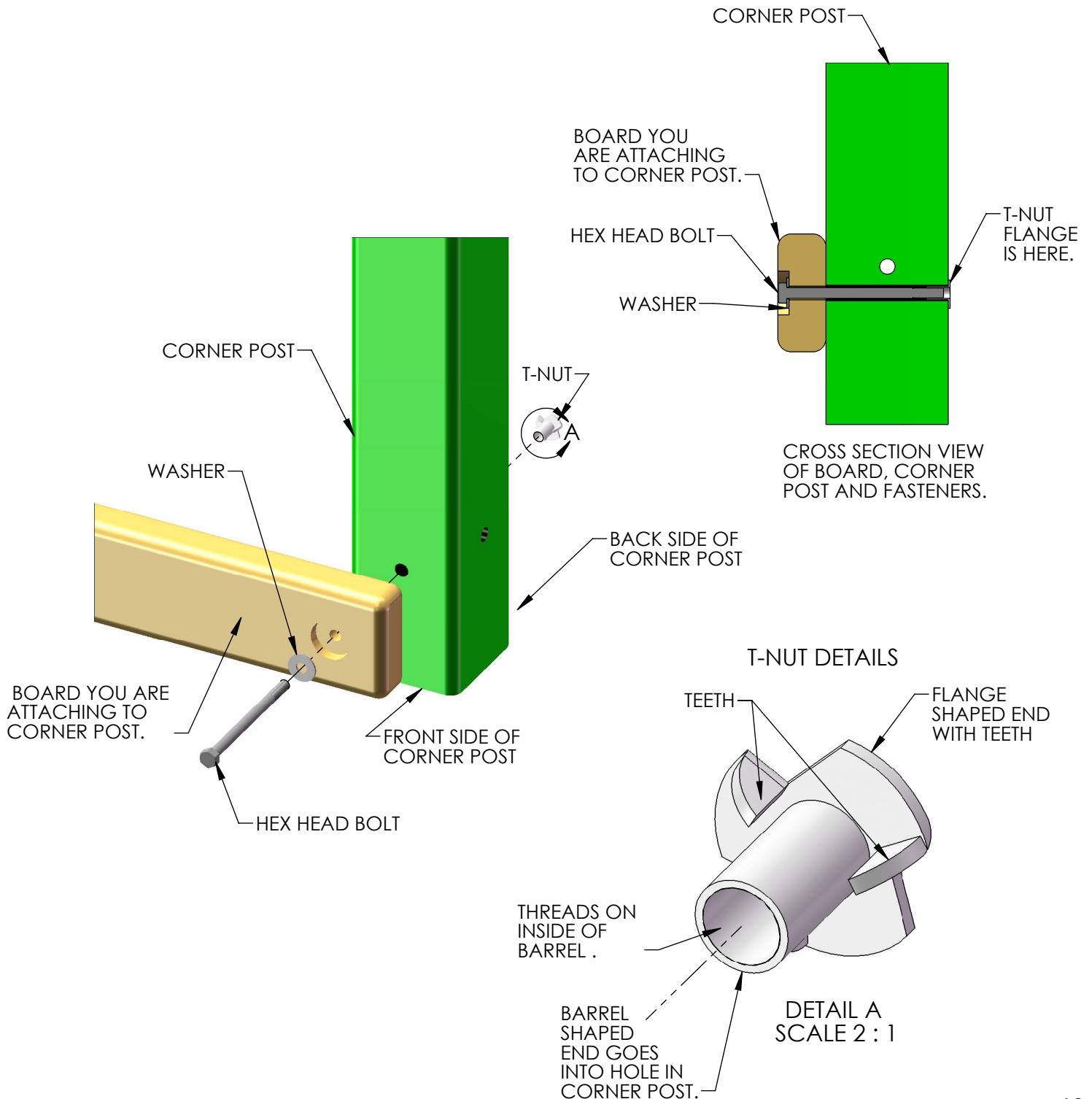

# BOARD IDENTIFICATION

1. On the end of each board there should be a small white tag that is stapled or stuck into place. Remove the staples and/or tag after the board is installed.
2. This white identification tag displays the thickness, width, length and an abbreviated description of the part.

Example: a tag reads "2-4-3600-BPB"

- The 2 is the thickness of the board. "Nominal Lumber" at a home center will measure 1-1/2" for the thickness. We "remill" that lumber to 1-3/8" thick.
- The 4 is the width of the board. "Nominal Lumber" at a home center will measure 3-1/2" for the width. We "remill" that lumber to 3-3/8" wide.  
Note: sometimes the width will be smaller than 3-3/8" because:  
A) We need the width of the part to fit into a certain area of the play set.  
B) We need the designation to be simple.
- The 3600 is the length of the board. It means the board is 36 inches long. If the code were 3625 then the board is 36-1/4" in length.
- The "BPB" abbreviation stands for "Bottom Panel Board". The wood part bill of materials in the instructions has a description which will match the abbreviation closely.
- In the event that there is no tag on a wood part measure the part then:  
A) Use the measurements and compare them to the wood list at the front of the instructions to identify it.  
B) Look at the holes on the wood part and compare them to the pictures in the wood list.  
C) Look to see if the holes are centered or if they are offset up or offset down.  
This should help you identify any parts that have missing tags. In the event that you cannot identify a board please email us for assistance.



# PRE-DRILL LAG SCREW DIRECTIONS

Pre-drilling holes for lag screws will make it easier to drive the screws in by hand. "Jobber" length drill bits are available in sizes that are longer than standard drill bits and those are ideal for the job. When using the drill bit you will have to "spot" drill the post and then remove the board you are attaching to finish drilling the hole.

Pay attention to the *DIAMETER* of the lag screw you are installing. Your playset may come with two different diameter lag screws. Each diameter will require a different size drill bit. When installing lag screws **DO NOT OVERTIGHTEN.**

LAG SCREW DIAMETER	DRILL BIT SIZE
5/16" DIAMETER	9/64"
3/8" DIAMETER	11/64"

### Example: 3/8" diameter x 3-1/2" lag screw

This would be like the 2 x 4 board installation shown below. Place the board into position. Spot Drill through the holes in the 2 x 4 board into the corner posts with an 11/64" drill bit. Remove the 2 x 4 board. Continue to drill the holes to a total depth of 2-5/16" as shown at the right. Install the 2 x 4 board.

### Example 5/16" diameter x 3-1/2" lag screw

This would be like the 2 x 4 board installation shown below. Place the board into position. Spot Drill through the holes in the 2 x 4 board into the corner posts with an 9/64" drill bit. Remove the 2 x 4 board. Continue to drill the holes to a total depth of 2-5/16" as shown at the right. Install the 2 x 4 board.

### Example 3/8" diameter x 5" lag screw

This would be like the 4 x 4 board installation shown below. Place the board into position. Spot drill through the holes in the 4 x 4 board into the corner posts with an 11/64" drill bit. Remove the 4 x 4 board. Continue to drill the holes to a total depth of 2-13/16" as shown at the right. Install the 4 x 4 board.

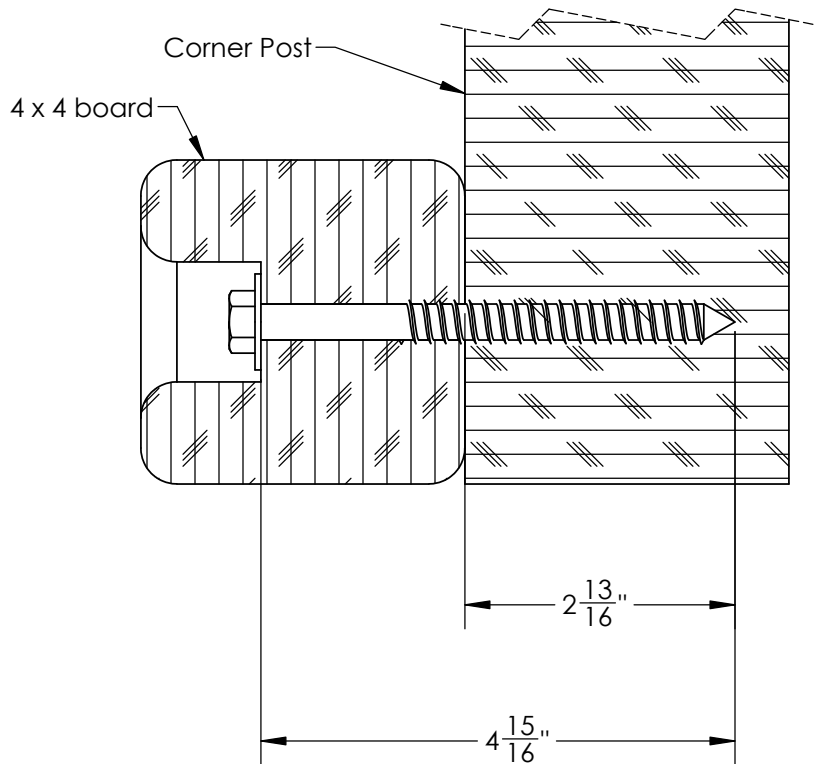
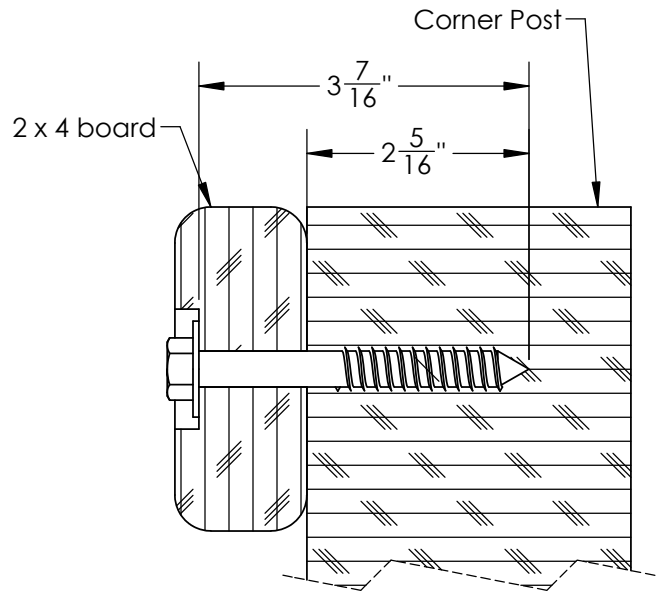

# SWING BEAM LOADING

## Weight Limits for Accessories:

The weight limit for a Swing Belt is 225 lbs. (Although 150 lbs is the maximum recommended swinging weight capacity for the swing position.)

The weight limit for a Trapeze Bar is 125 lbs.

## Maximum allowable swinging weight for a two position swing:

- 1) The maximum allowable swinging weight at each Swing Belt position is 150 lbs.
- 2) The maximum allowable swinging weight at each Trapeze position is 125 lbs.
- 3) The **MAXIMUM SWING BEAM LOAD** is 275 lbs.

## **MAXIMUM SWING BEAM LOAD IS 275 LBS.**

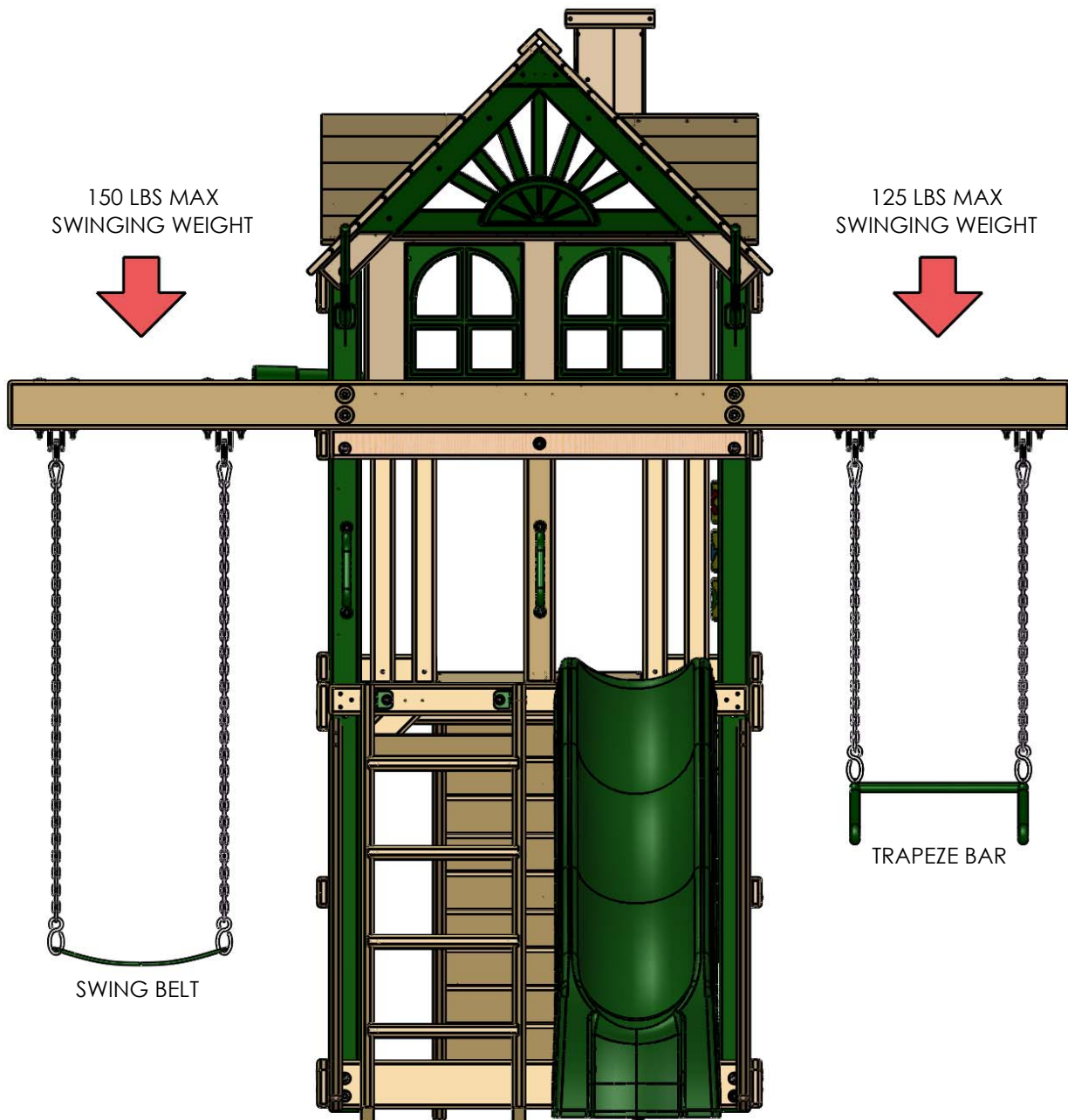

**Please familiarize yourself with the manual, parts/components and general construction process of your new playset before getting started.**

**SITE PLAN:**

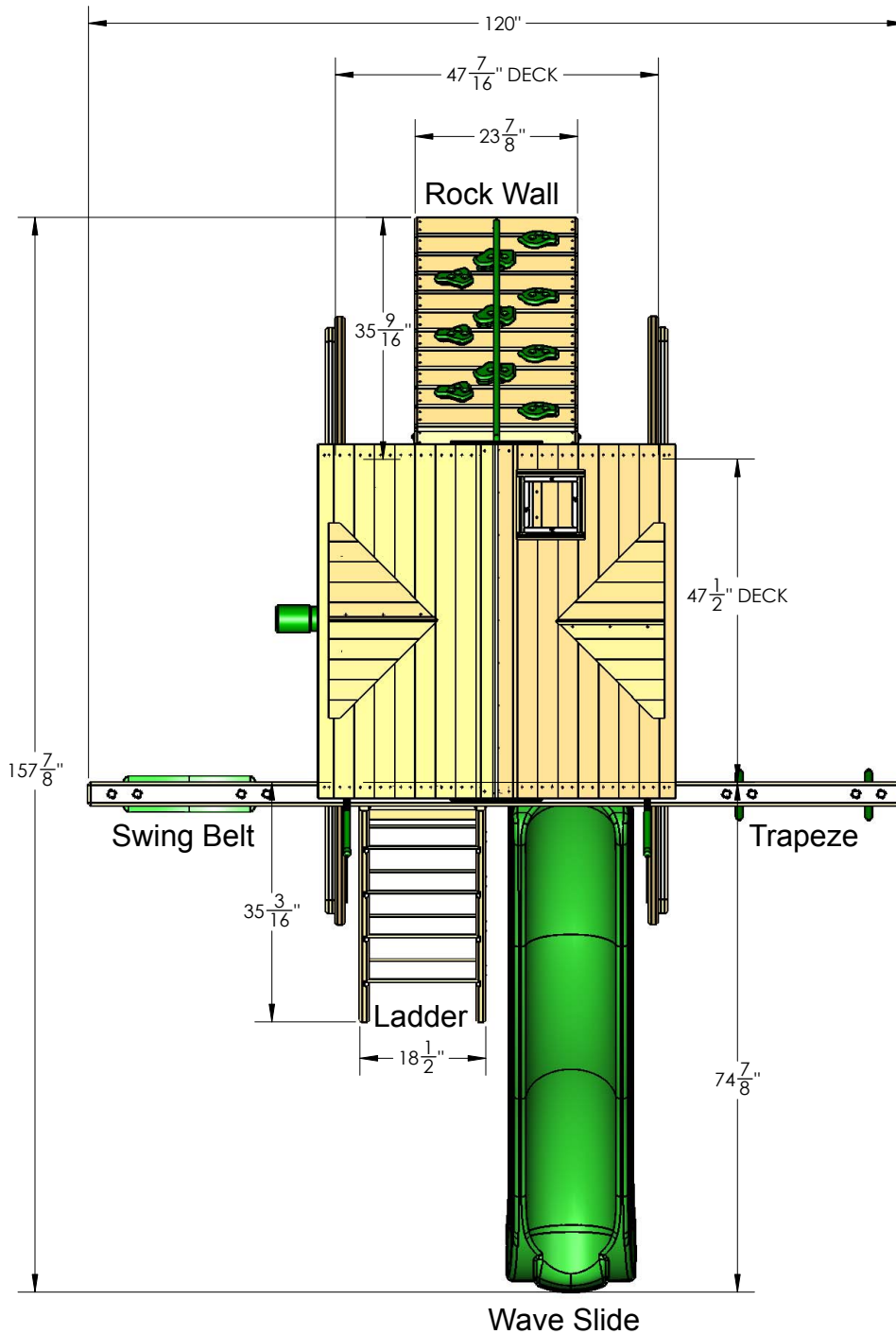

Playset height: 10' - 4-1/2"

Swing Beam height: 6' - 10-1/2"

Approximate assembly time: 8-10 hours

**(6) foot unobstructed safety perimeter around playset recommended**

## **REQUIRED TOOL & MATERIALS LIST:**

- \_\_\_ Standard or Cordless Drill w/ Phillips Bit (#2 square bit provided)
- \_\_\_ Drill Bits 1/8", 3/8", 9/64", 11/64".
- \_\_\_ 1/2" Wrench and Socket
- \_\_\_ 1/2" Deep Well Socket
- \_\_\_ 9/16" Deep Well Socket
- \_\_\_ 9/16" Wrench and Socket
- \_\_\_ Level
- \_\_\_ Tape Measure
- \_\_\_ Extension Cord (if using standard drill)
- \_\_\_ Hammer
- \_\_\_ Pencil
- \_\_\_ Locking Pliers (Vise Grips)
- \_\_\_ Shovel
- \_\_\_ Post Hole Digger
- \_\_\_ Concrete 60# bags - 6 bags

## **KIT CONTENTS**

### **Swings, Slides, Accessories:**

- \_\_\_ (Qty ) Description
- \_\_\_ (1) Swingbelt w/ Chains
- \_\_\_ (1) Trapeze Swing
- \_\_\_ (1) 8ft. Wave Slide
- \_\_\_ (1) Trapeze Swing
- \_\_\_ (1) Telescope
- \_\_\_ (1) Safety Handles (pair)
- \_\_\_ (10') Rock Wall Rope
- \_\_\_ (1) Chalk Board
- \_\_\_ (2) Plastic Sunburst 07-0028-G
- \_\_\_ (2) Plastic Dormer Window 07-0029-G
- \_\_\_ (1) Flag Kit (pair)
- \_\_\_ (2) Plastic Dormer Sunburst
- \_\_\_ (10) Rock Wall Grips (assorted colors)
- \_\_\_ (1) Tic Tac Toe

### **Fort Hardware:**

*see following pages*

### **Swing Beam Hardware:**

*see following pages*

### **Wood Components:**

*see following pages*

11-0083  
 380 Hardware  
 PAGE 1 OF 2  
 REV: A 10/20/2016 S.O.

#14 X 1-1/4"  
 PAN HEAD  
 SCREW  
 QTY: 3



#8 X 1-1/4"  
 WOOD SCREW  
 QTY: 15



#8 X 1-1/2"  
 WOOD SCREW  
 QTY: 106



#8 X 2"  
 WOOD SCREW  
 QTY: 191



#8 X 2-1/2"  
 WOOD SCREW  
 QTY: 40



#8 X 3"  
 WOOD SCREW  
 QTY: 10



5/16 X 4-1/2"  
 HEX BOLT  
 QTY: 32

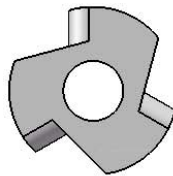

5/16" TEE NUT  
 QTY: 43

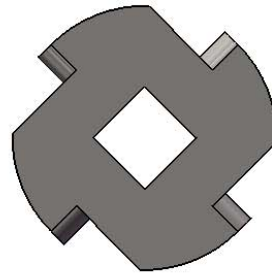

TORQUE WASHER  
 QTY: 17



3/8" LOCK NUT  
 QTY: 19



5/16" X 2-1/2"  
 HEX BOLT  
 QTY: 3



5/16 X 1-1/2"  
 HEX BOLT  
 QTY: 8

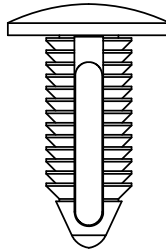

3/8"  $\phi$  X 1-1/8"  
 BLACK PLASTIC  
 PLUG  
 QTY: 4

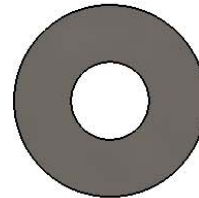

3/8" WASHER  
 QTY: 31

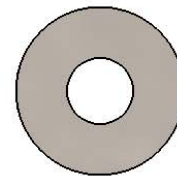

5/16" WASHER  
 QTY: 68

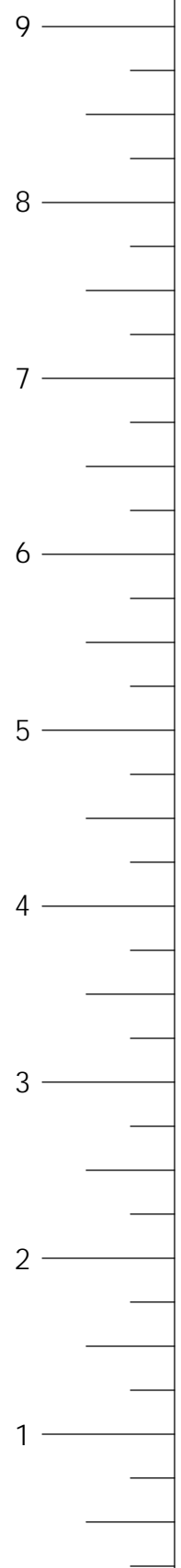

USE THE RULER TO THE RIGHT TO MEASURE YOUR BOLTS AND SCREWS. PICTURE VIEWS SHOWN ABOVE ARE 1:1 SCALE AND CAN BE USED TO MATCH BOLT AND SCREW SIZES.



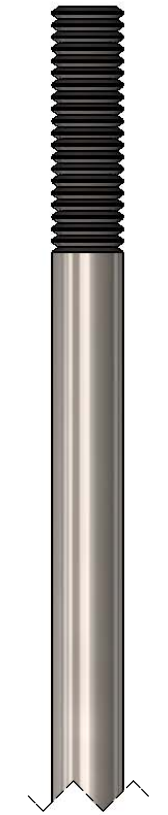

3/8 x 9"  
 CARRIAGE BOLT  
 QTY: 1

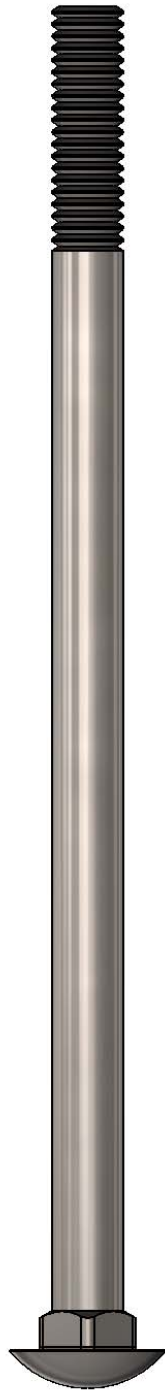

3/8 x 7"  
 CARRIAGE BOLT  
 QTY: 12

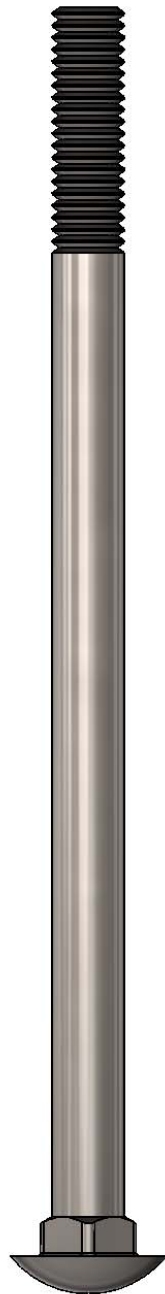

3/8 x 6-1/2"  
 CARRIAGE BOLT  
 QTY: 4

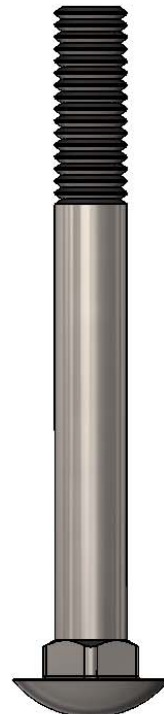

3/8 x 3-1/2"  
 CARRIAGE BOLT  
 QTY: 2

5/16" X 3-1/2"  
 HEX LAG  
 SCREW  
 QTY: 22

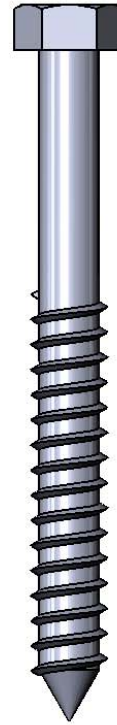

3/8 X 3-1/2"  
 HEX LAG  
 SCREW  
 QTY: 12

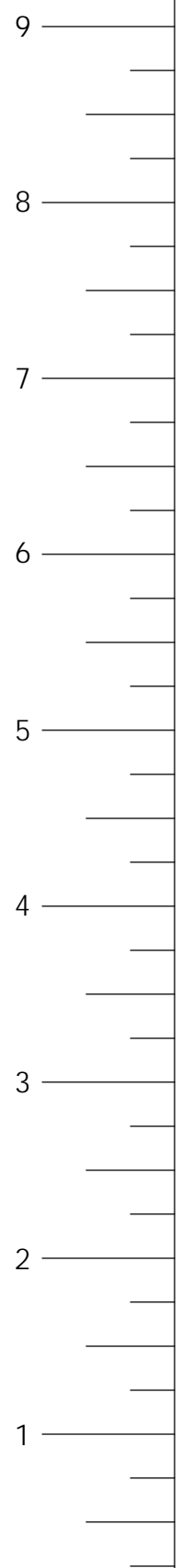
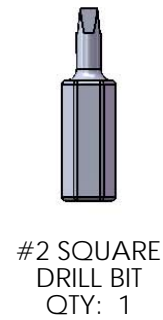
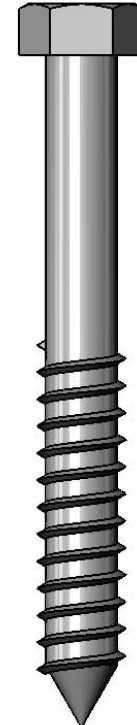

USE THE RULER TO THE RIGHT TO MEASURE YOUR BOLTS AND SCREWS. PICTURE VIEWS SHOWN ABOVE ARE 1:1 SCALE AND CAN BE USED TO MATCH BOLT AND SCREW SIZES.

11-0094  
383 Hardware  
5/3/2018 JH

#8 X 2-1/2"  
WOOD SCREW  
QTY: 2



#8 X 3"  
WOOD SCREW  
QTY: 2

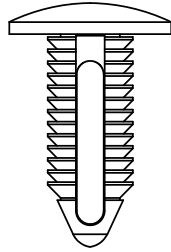

BLACK PLUG  
Ø 3/8" X 1-1/8"  
QTY: 4

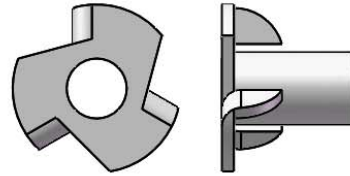

5/16" T-NUT  
QTY: 10

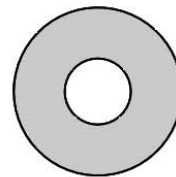

5/16" WASHER  
QTY: 16

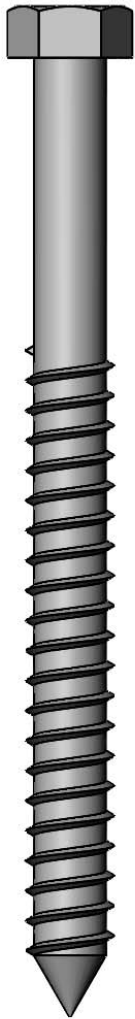

3/8" X 5"  
LAG SCREW  
QTY: 2

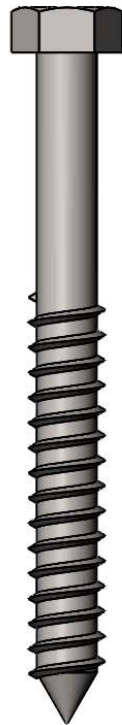

5/16" X 3-1/2"  
LAG SCREW  
QTY: 6

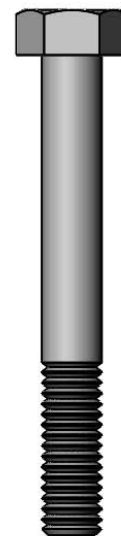

5/16" X 2-1/2"  
HEX BOLT  
QTY: 10

9  
8  
7  
6  
5  
4  
3  
2  
1



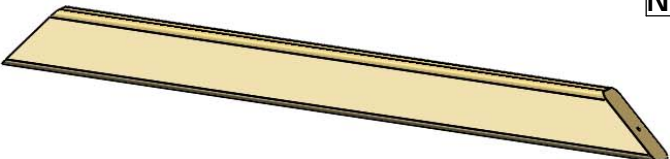
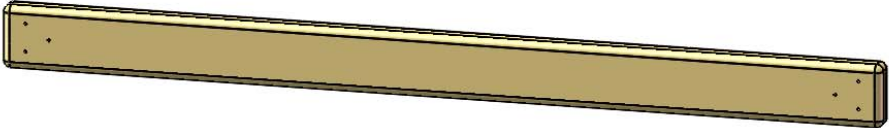
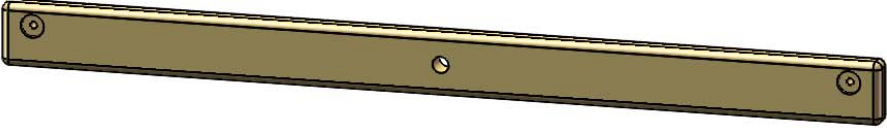
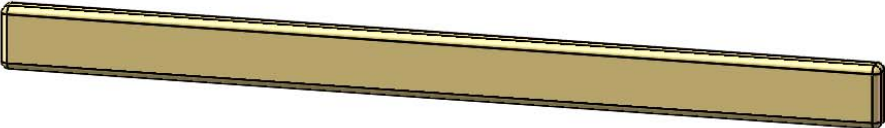
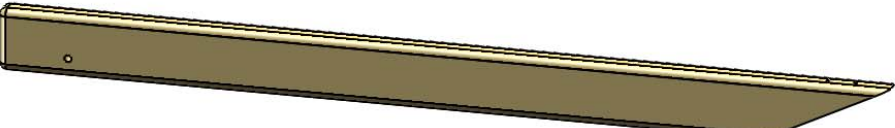
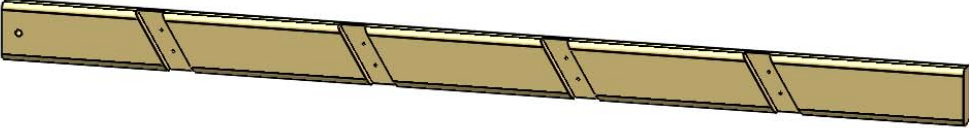

USE THE RULER TO THE RIGHT TO MEASURE YOUR BOLTS AND SCREWS. PICTURE VIEWS SHOWN ABOVE ARE 1:1 SCALE AND CAN BE USED TO MATCH BOLT AND SCREW SIZES.

380	PICTURE	DESCRIPTION	QTY.
		2 X 4 X 12" BOTTOM PANEL BOARD RIGHT <b>2-4-1200-BPBR</b>	1
		2 X 4 X 12" BOTTOM PANEL BOARD LEFT <b>2-4-1200-BPBL</b>	1
		2 X 4 X 13" ANGLE SUPPORT <b>2-4-1300-AS</b>	8
		2 X 4 X 17" LADDER STEP <b>2-4-1700-LS</b>	4
	<p style="text-align: right;"><b>NOT USED</b></p>	2 X 4 X 28-5/8" CENTER POST <b>2-4-2863-CP</b>	1
		2 X 4 X 35-1/2" ROOF SUPPORT LEFT <b>2-4-3550-RSL</b>	2
		2 X 4 X 35-1/2" ROOF SUPPORT RIGHT <b>2-4-3550-RSR</b>	2

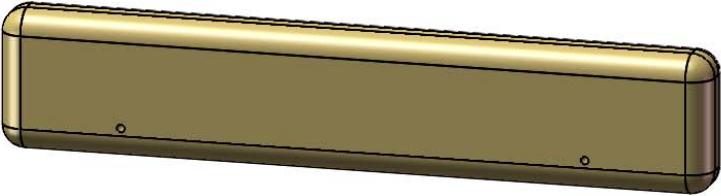
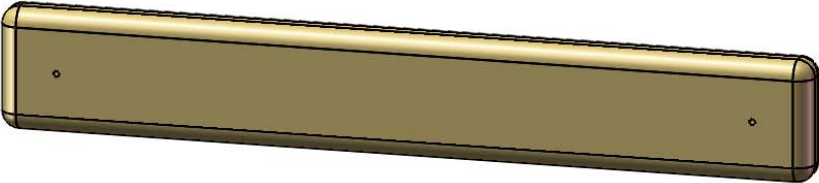
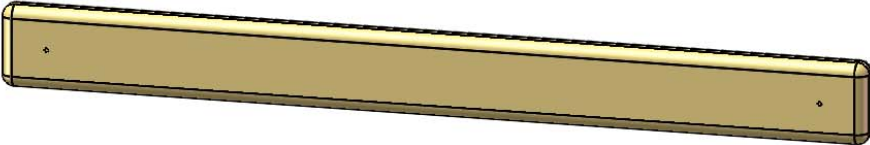
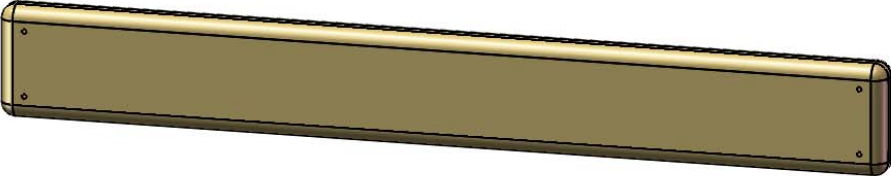
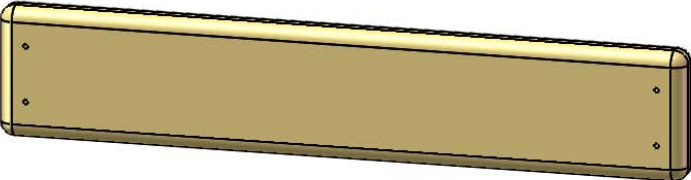
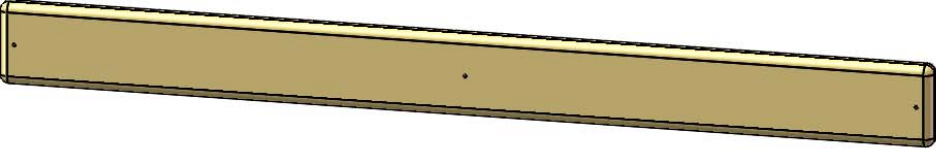
PICTURE	DESCRIPTION	QTY.
	2 X 4 X 39-1/2" SUNBURST FILLER BOARD <b>2-4-3950-SFB</b>	1
	2 X 4 X 47-3/8" FACE BOARD <b>2-4-4738-FB</b>	2
	2 X 4 X 47-3/8" PANEL AND DECK SUPPORT <b>2-4-4738-PDS</b>	9
	2 X 4 X 47-3/8" ROCKWALL SIDE TOP PANEL BOARD <b>2-4-4738-RWSTPB</b>	1
	2 X 4 X 47-3/8" STRINGER <b>2-4-4738-S</b>	1
	2 X 4 X 48" FORT SUPPORT <b>2-4-4800-FS</b>	2
	2 X 4 X 57" LADDER LEFT SIDE <b>2-4-5700-LLS</b>	1

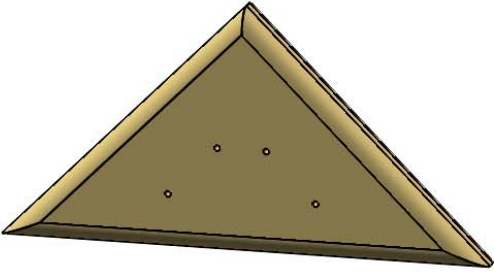
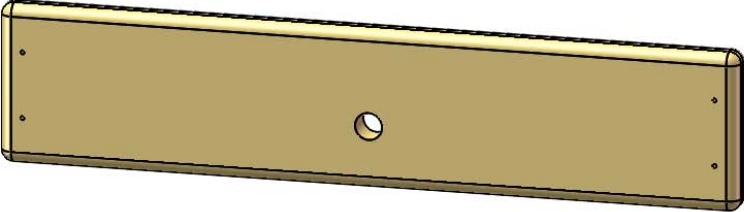
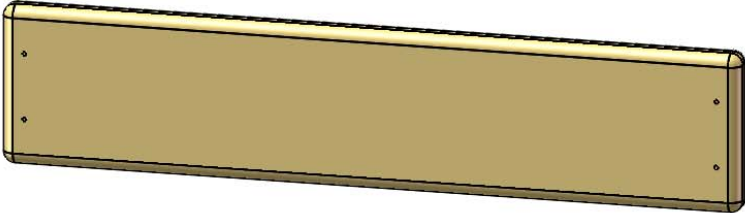
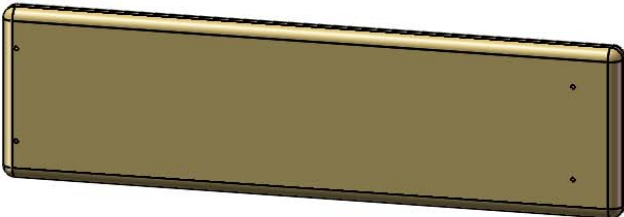
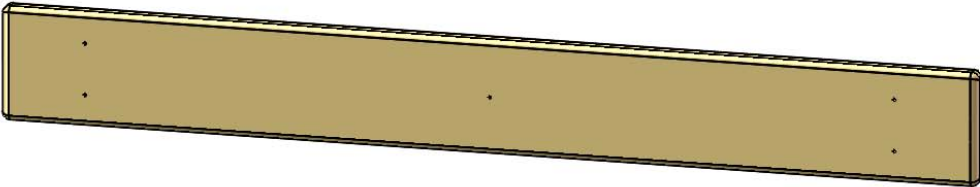
PICTURE	DESCRIPTION	QTY.
	2 X 4 X 57" LADDER RIGHT SIDE <b>2-4-5700-LRS</b>	1
	2 X 4 X 57" ROCK WALL SIDE <b>2-4-5700-RWS</b>	2
<div style="text-align: right; border: 1px solid black; padding: 2px; display: inline-block;"><b>NOT USED</b></div> 	2 X 4 X 58" SWING LEG CROSS MEMBER <b>2-4-5800-CM</b>	1
	2 X 6 X 47-3/8" ARCHED SIDE TOP BOARD <b>2-6-4738-ASTB</b>	2
<div style="text-align: right; border: 1px solid black; padding: 2px; display: inline-block;"><b>NOT USED</b></div> 	2 X 6 X 47-3/8" FRONT ARCH BOARD <b>2-6-4738-FAB</b>	1
	2 X 6 X 47-3/8" END SANDBOX BOARD <b>2-6-4738-ESB</b>	3
	2 X 6 X 86" OUTRIGGER <b>2-6-8600-OR</b>	1

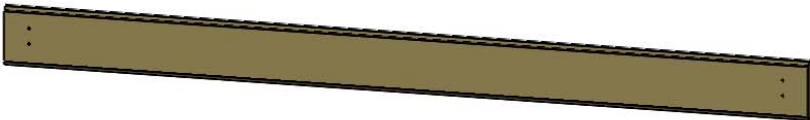
PICTURE	DESCRIPTION	QTY.
<p style="text-align: right;"><b>NOT USED</b></p> 	<p>4 X 4 X 47-3/8" SWING BEAM MOUNT <b>4-4-4738-SBM</b></p>	<p style="text-align: center;">1</p>
	<p>5/4 X 2-1/4 X 11-1/2" HORIZONTAL WINDOW SUPPORT <b>125-225-1150-HWS</b></p>	<p style="text-align: center;">4</p>
	<p>5/4 X 2-5/8 X 17-1/2" TIC TAC TOE MOUNT <b>125-3-1750-TTM</b></p>	<p style="text-align: center;">2</p>
<p style="text-align: center;"><b>1 WILL BE LEFT OVER</b></p> 	<p>5/4 X 2-5/8 X 28" PANEL SLAT <b>125-3-2800-PS</b></p>	<p style="text-align: center;">18</p>
	<p>5/4 X 3 X 23-7/8" ROCK WALL TOP CAP <b>125-3-2388-RWTC</b></p>	<p style="text-align: center;">1</p>
	<p>5/4 X 3-1/2 X 18-1/2" LADDER BACK <b>125-4-1850-LB</b></p>	<p style="text-align: center;">1</p>
	<p>5/4 X 3-1/2 X 40-1/4" DECK SPACER <b>125-4-4025-DS</b></p>	<p style="text-align: center;">2</p>

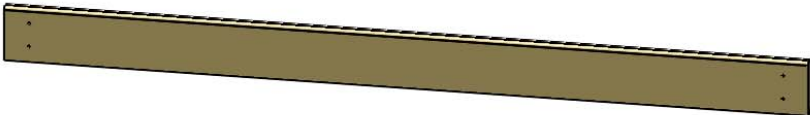
PICTURE		DESCRIPTION	QTY.
		5/4 X 5 X 10" ROOF PEAK SUPPORT <b>125-6-1000-RPS</b>	2
		5/4 X 5-1/8 X 23-7/8" BOTTOM ROCK WALL BOARD <b>125-5-2388-BRWB</b>	1
		5/4 X 5-1/8 X 23-7/8" ROCK WALL BOARD <b>125-5-2388-BRWB</b>	10
		5/4 X 5-1/2 X 20" VERTICAL WINDOW SUPPORT <b>125-6-2000-VWS</b>	3
		5/4 X 5-1/2 X 47-3/8" DECK BOARD <b>125-6-4738-DB</b>	7
		1 X 3.783 X 52" ROOF FINISHER <b>1-5-5200-RF</b>	2
		1 X 3-1/2 X 52" ROOF STARTER <b>1-5-5200-RS</b>	2

PICTURE		DESCRIPTION	QTY.
		1 X 6 X 52" ROOF PEAK 1-6-5200-RP	1
		1 X 4-1/2 X 52" ROOF BOARD 1-5-5200-RB	14
		4 X 4 X 96" CORNER POST LEFT 4-4-9600-CPL	2
		4 X 4 X 96" CORNER POST RIGHT 4-4-9600-CPR	2

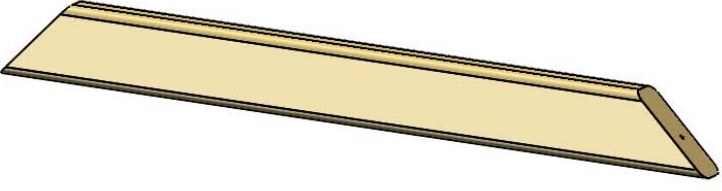
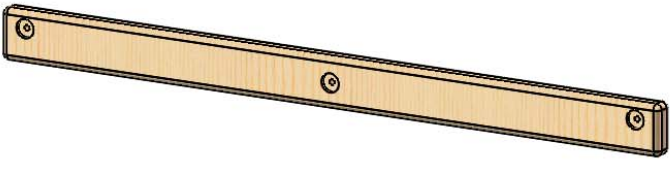
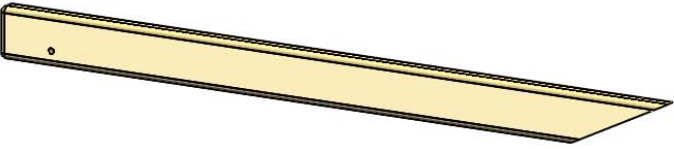
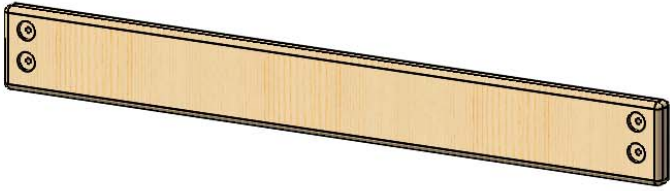
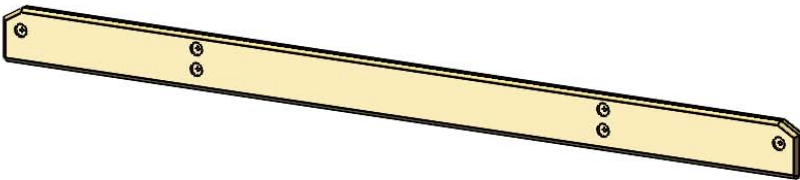
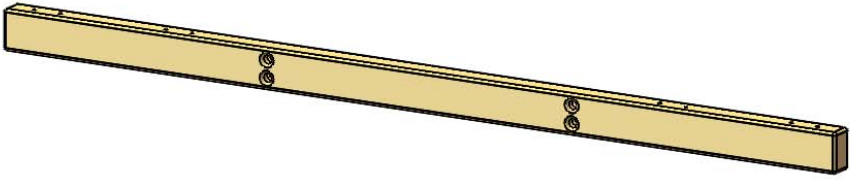

383	PICTURE	DESCRIPTION	QTY.
		2 X 4 X 28-5/8" CENTER POST <b>2-4-2863-CP</b>	1
		2 X 4 X 34" SUNBURST FILLER BOARD <b>2-4-3400-SFB</b>	1
		2 X 4 X 47-3/8" FRONT PANEL SUPPORT <b>2-4-4738-FPS</b>	1
		2 X 4 X 48" FORT SUPPORT <b>2-4-4800-FS</b>	2
		2 X 6 X 47-3/8" BOTTOM PANEL AND SANDBOX BOARD <b>2-6-4738-BPSB</b>	1
		2 X 6 X 86" OUTRIGGER <b>2-6-8600-OR</b>	1
		4 X 6 X 120" SPACE SAVER SWING BEAM <b>4-6-12000-SSB</b>	1

P.T. PINE U.S.	PICTURE	DESCRIPTION	QTY.
		2 X 4 X 31" INGROUND MOUNTS <b>2-4-3100-IGSF</b>	4
			26

PICTURE

DESCRIPTION

QTY.

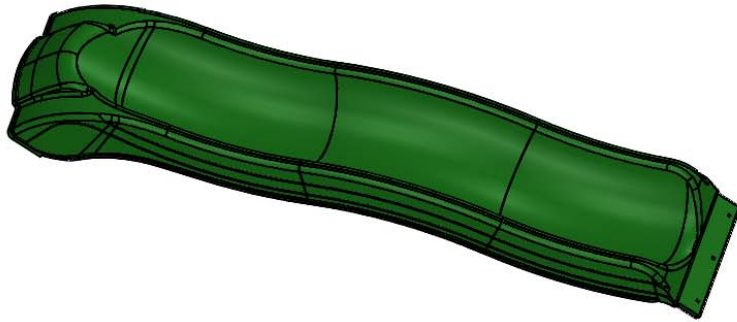

8'  
WAVE  
SLIDE  
03-0016-G

1

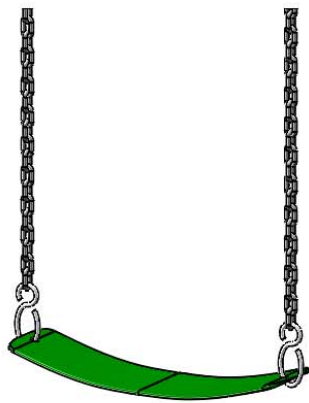

SWING  
W/CHAINS  
04-0002

1



TRAPEZE  
BAR  
W/CHAINS  
04-0006

1

PICTURE

DESCRIPTION

QTY.

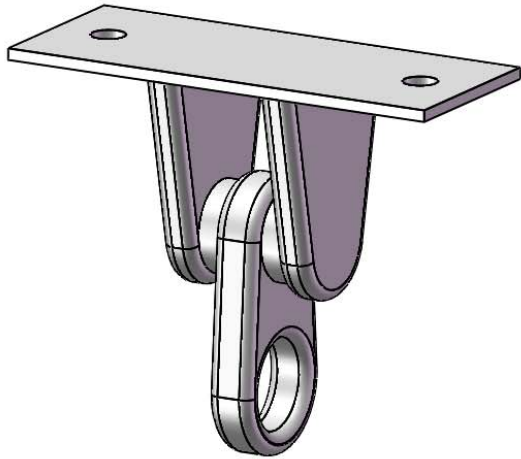

IRON  
DUCTILE  
SWING  
HANGERS  
11-4012

4

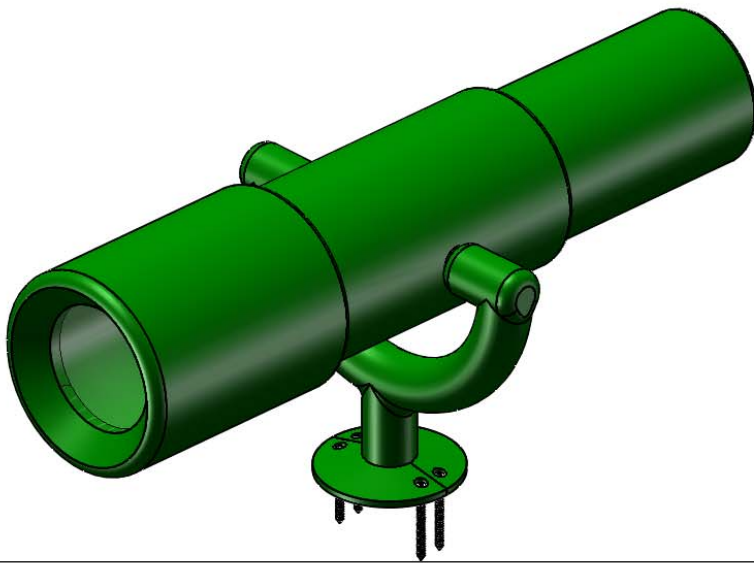

TELESCOPE  
07-0001

1

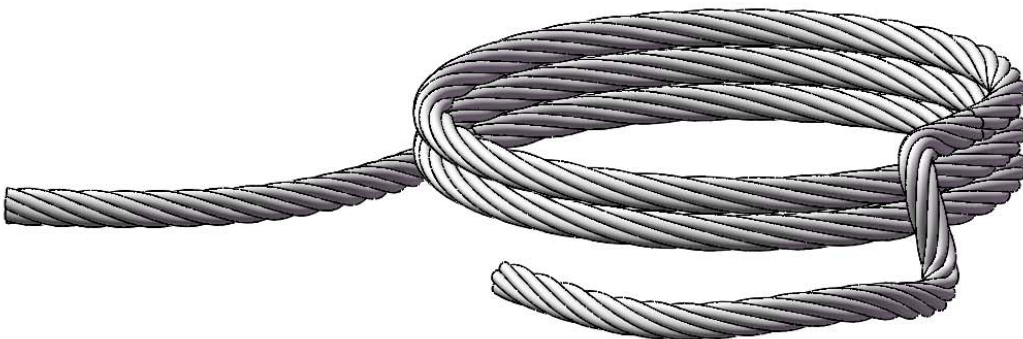

10'  
ROCK  
WALL  
ROPE

1

PICTURE

DESCRIPTION

QTY.

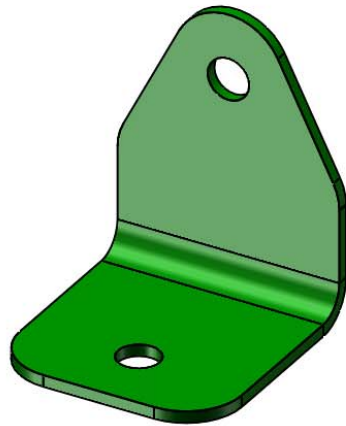

90° GREEN  
BRACKET  
11-5013

4

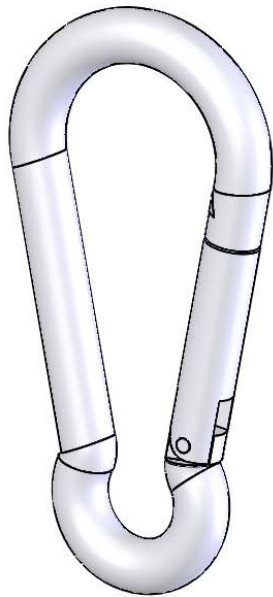



SPRING  
CLIP  
11-4003

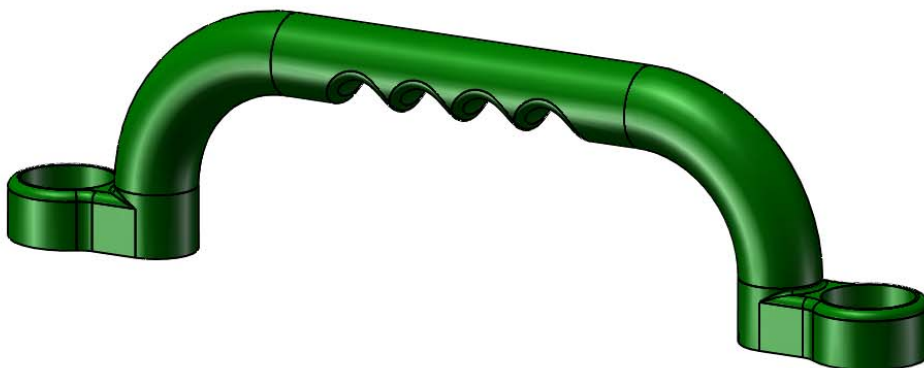

4

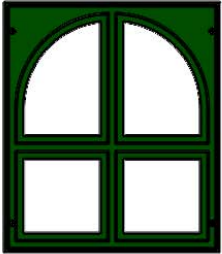
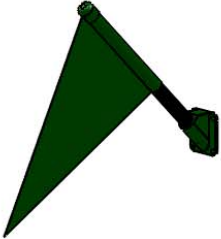
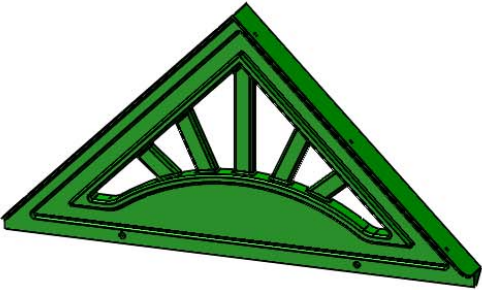

SAFETY  
HANDLES  
(PAIR)  
07-0005

1 pr

PICTURE	DESCRIPTION	QTY.
	<p>CHALK BOARD 07-0028-G</p>	<p>1</p>
	<p>PLASTIC SUNBURST 07-0028-G</p>	<p>2</p>
	<p>PLASTIC DORMER WINDOW 07-0029-G</p>	<p>2</p>
	<p>FLAG KIT 09-1014</p>	<p>1 pr</p>
	<p>PLASTIC DORMER SUNBURST 07-0031</p>	<p>2</p>

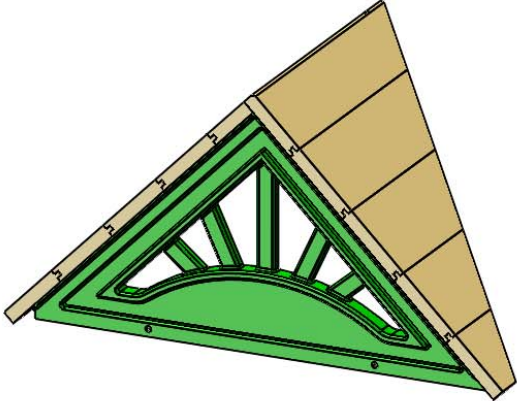
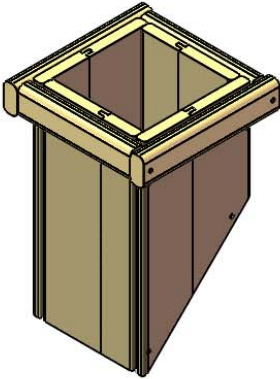
PICTURE	DESCRIPTION	QTY.
(NOT SHOWN)	MANUFACTURER LOGO PLATE	1
	CLIMBING ROCKS (07-0008 IS A PACK OF 5)	10 ROCKS
	TIC TAC TOE (UNASSEMBLED) <b>07-0010</b>	1
	UNASSEMBLED DORMER (320 BOX)	2
	UNASSEMBLED CHIMNEY (320 BOX)	1

# STEP 1: CORNER POST LAYOUT

1: This step is critical to building the fort properly. If any mistakes are made here, you will need to dis-assemble and then re-assemble to make your corrections.

2: Lay out each of the 4 x 4 x 96" Corner Posts in the area you intend on building the fort side of the playset.

3: Use the diagram below to correctly identify and orient the necessary direction the posts should face. Note: the Slide side is considered the front of the playset.

4 X 4 X 96"  
CORNER  
POST

Note:  
Corner Posts are  
**NOT** pre-labeled.  
The text shown  
below the posts are  
for reference during  
the construction  
process.

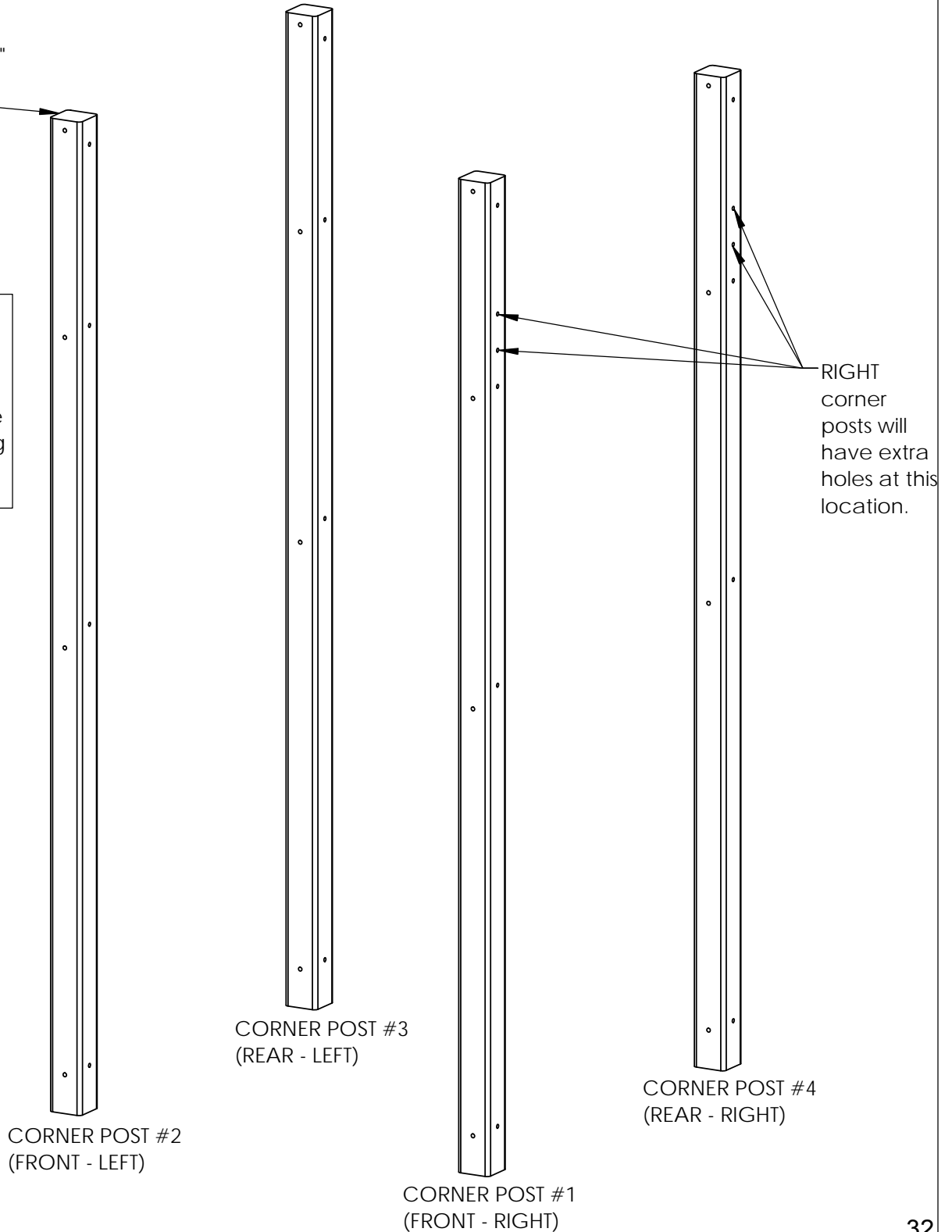



## STEP 2: INSERTING T-NUTS INTO THE CORNER POSTS

1: Use a hammer to seat the t-nuts after inserting them into the holes shown in the diagram below.

2: The barrel of the t-nut should go in the hole first. Hammer the t-nut until it is flush/almost flush to the corner posts. No t-nuts will be installed in the right Corner Posts where shown below.

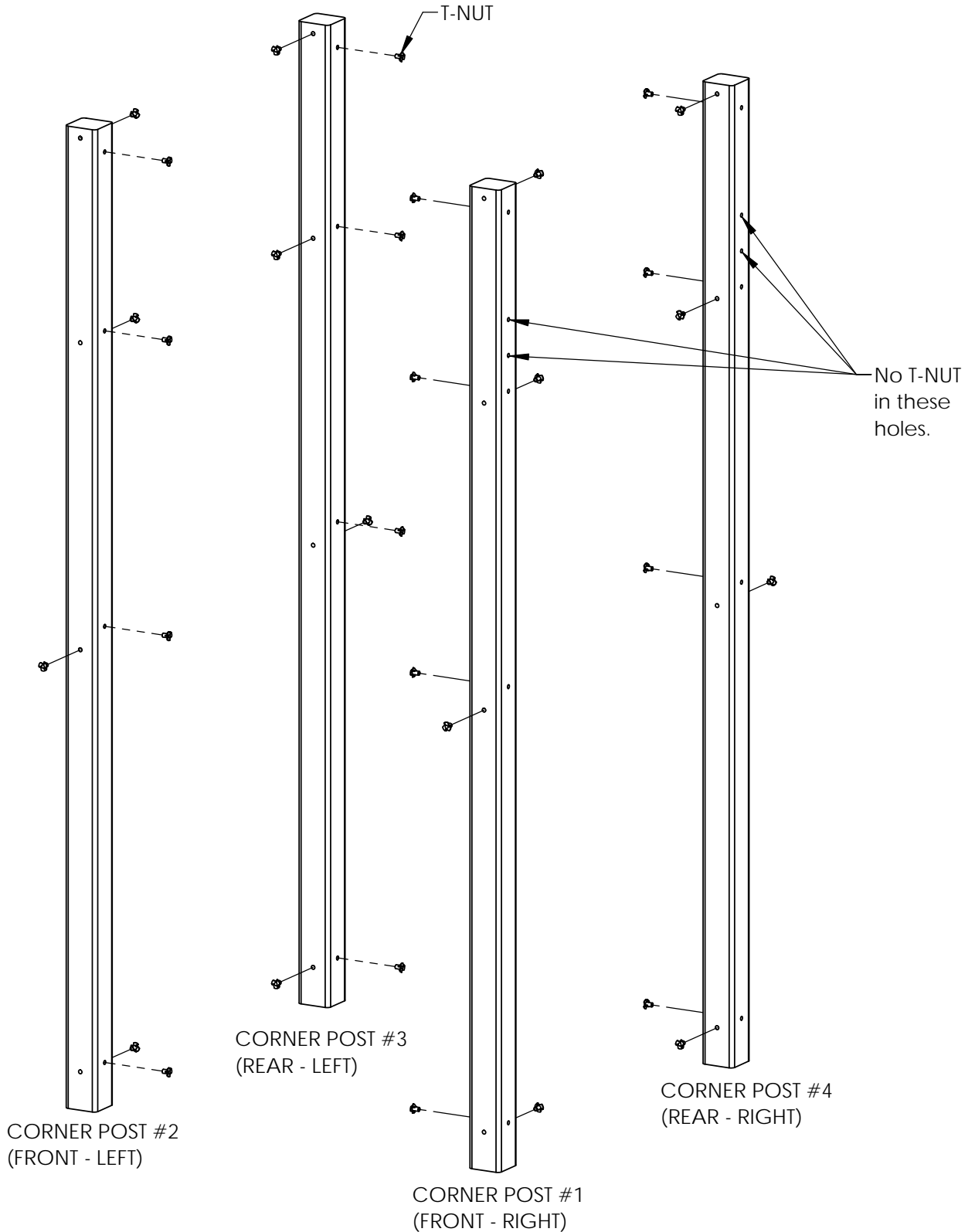

## STEP 3: RIGHT SIDE BOARDS

1: The 2 x 6 x 86" Outrigger attaches to the bottom of the right corner posts, offset holes up with two 5/16" x 4-1/2" hex bolts and two 5/16" washers.

2: The 2 x 6 x 47-3/8" Bottom Panel Board attaches in the middle of the right corner posts, offset holes up with two 5/16" x 4-1/2" hex bolts and two 5/16" washers.

3: The 2 x 4 x 47-3/8" Panel Support attaches above the Bottom Panel Board to the right corner posts, offset holes up with two 5/16" x 4-1/2" hex bolts and two 5/16" washers.

4: The 2 x 6 x 47-3/8" Arched Side Top Board attaches to the top of the right corner posts with two 5/16" x 4-1/2" hex bolts and two 5/16" washers.

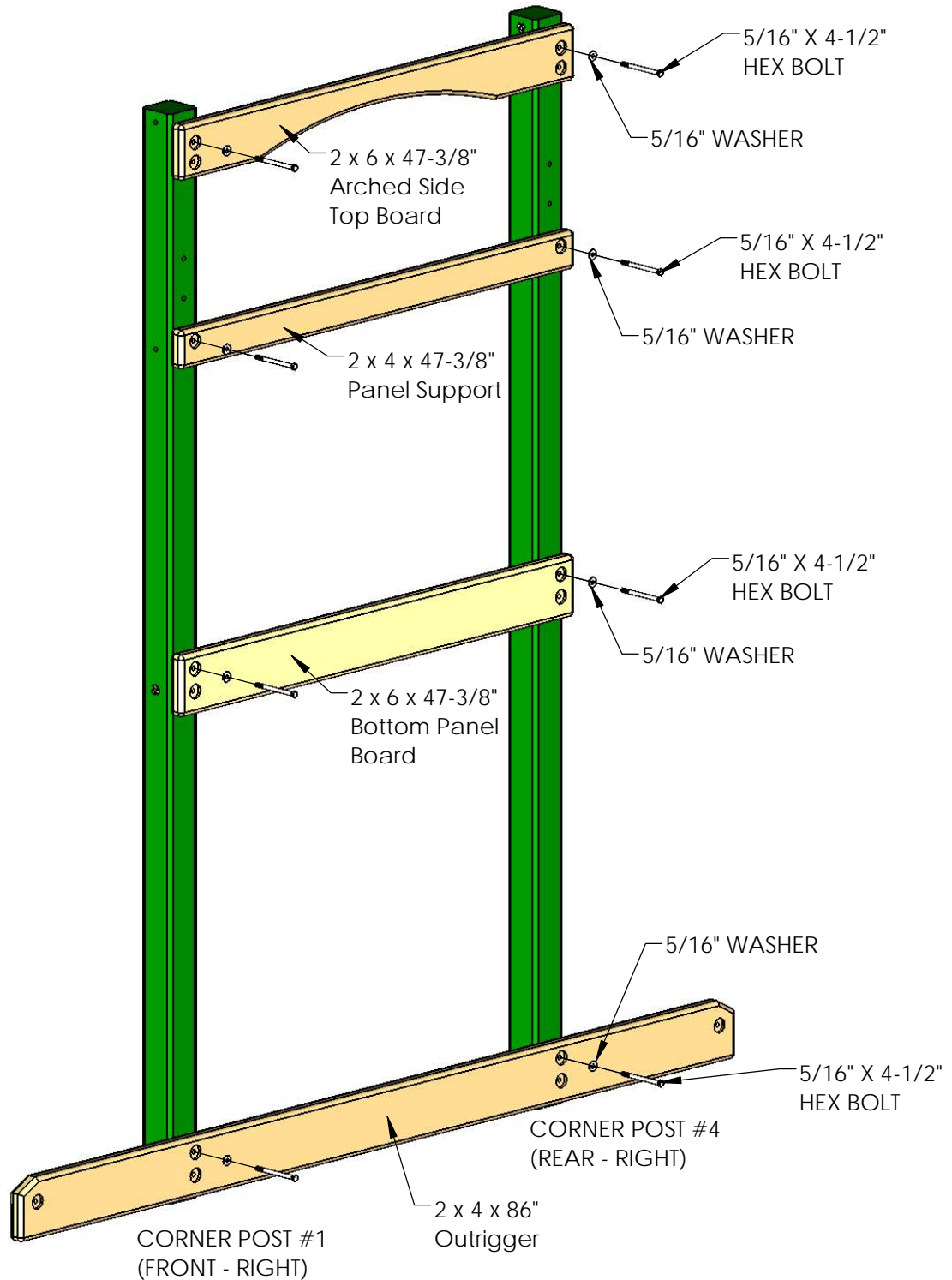

## STEP 4: LEFT SIDE BOARDS

1: The 2 x 6 x 86" Outrigger attaches to the bottom of the left corner posts, offset holes up with two 5/16" x 4-1/2" hex bolts and two 5/16" washers.

2: The 2 x 6 x 47-3/8" Bottom Panel Board attaches in the middle of the left corner posts, offset holes up with two 5/16" x 4-1/2" hex bolts and two 5/16" washers.

3: The 2 x 4 x 47-3/8" Panel Support attaches above the Bottom Panel Board to the left corner posts, offset holes up with two 5/16" x 4-1/2" hex bolts and two 5/16" washers.

4: The 2 x 6 x 47-3/8" Arched Side Top Board attaches to the top of the left corner posts with two 5/16" x 4-1/2" hex bolts and two 5/16" washers.

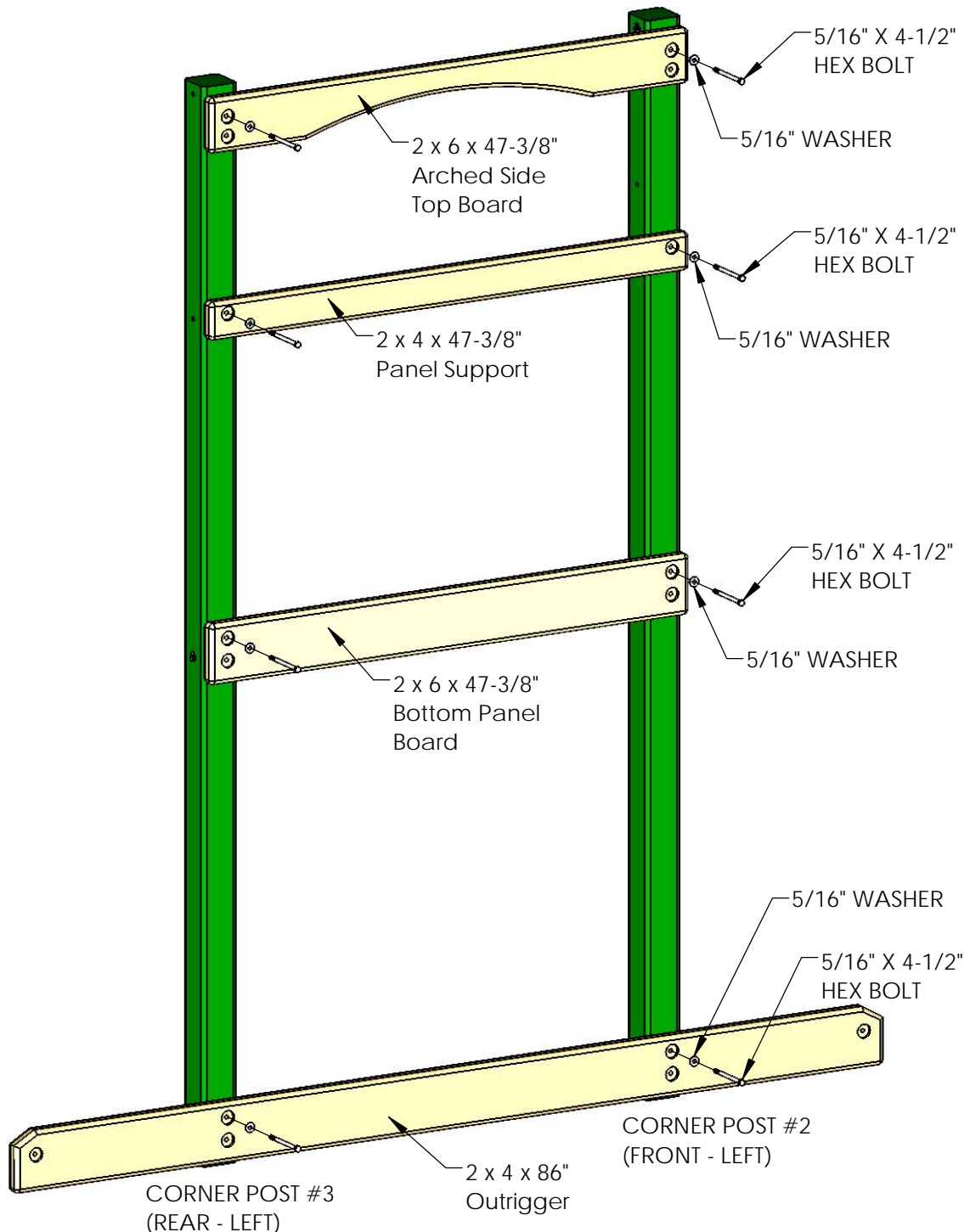

## STEP 5: DECK SUPPORTS AND SANDBOX BOARDS

Have an assistant help you hold up the left and right side assemblies as you perform this step.

1: Fasten the 2 x 4 x 47-3/8" Deck Supports, offset down to the corner posts with 5/16" x 4-1/2" hex bolts and 5/16" washers.

2: Fasten the 2 x 6 x 47-3/8" Sandbox Boards, offset down to the outside of the corner posts at the bottom with 5/16" x 4-1/2" hex bolts and 5/16" washers.

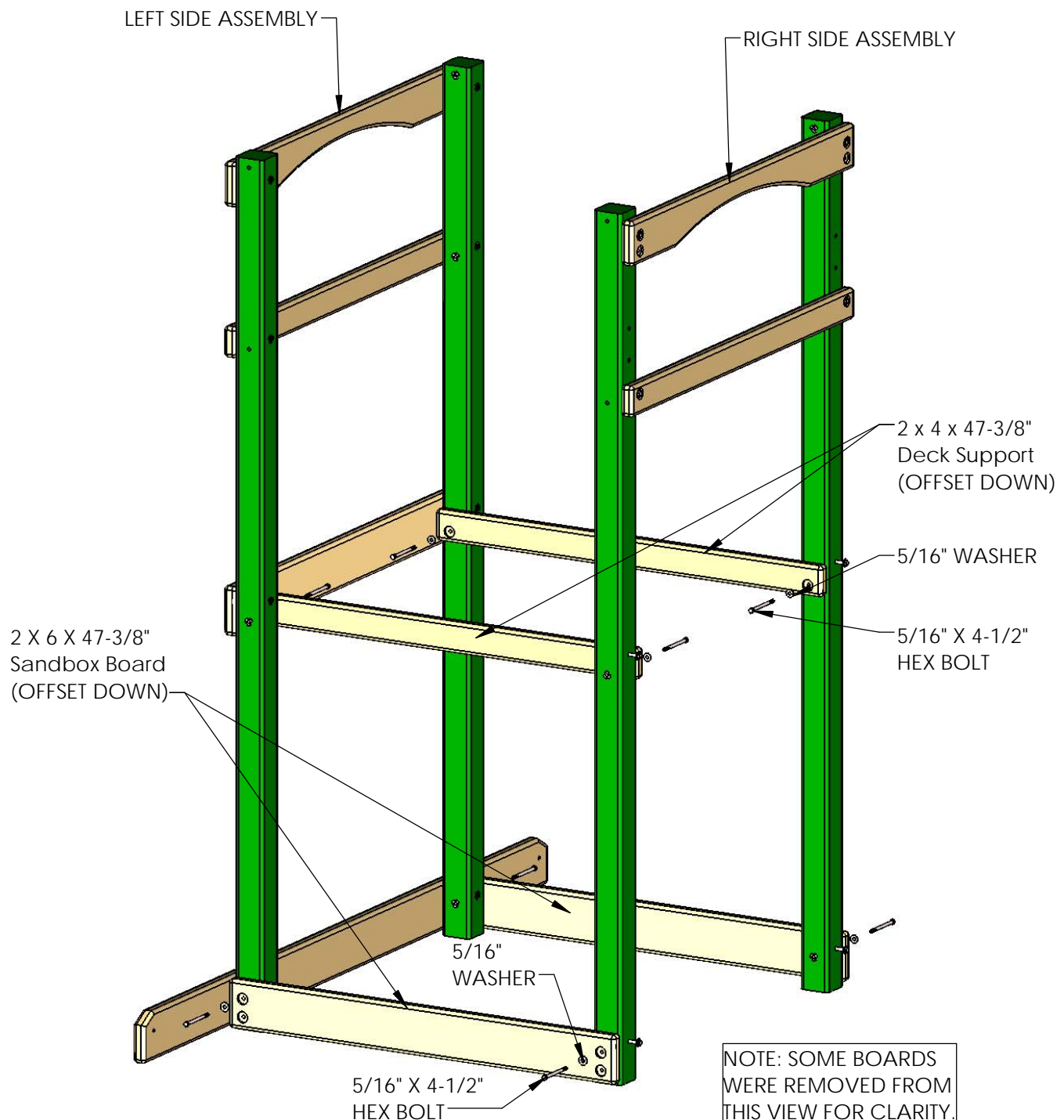

## STEP 6: PANEL SUPPORTS

1: Place the 2 x 4 x 47-3/8" Rock Wall Side Top Panel Board, offset down on the rear as shown. Fasten the board to the corner posts with 5/16" x 4-1/2" hex bolts and 5/16" washers.

2: Place the 2 x 4 x 47-3/8" Front Panel Support, offset down on the front as shown. Fasten the board to the corner posts with 5/16" x 4-1/2" hex bolts and 5/16" washers.

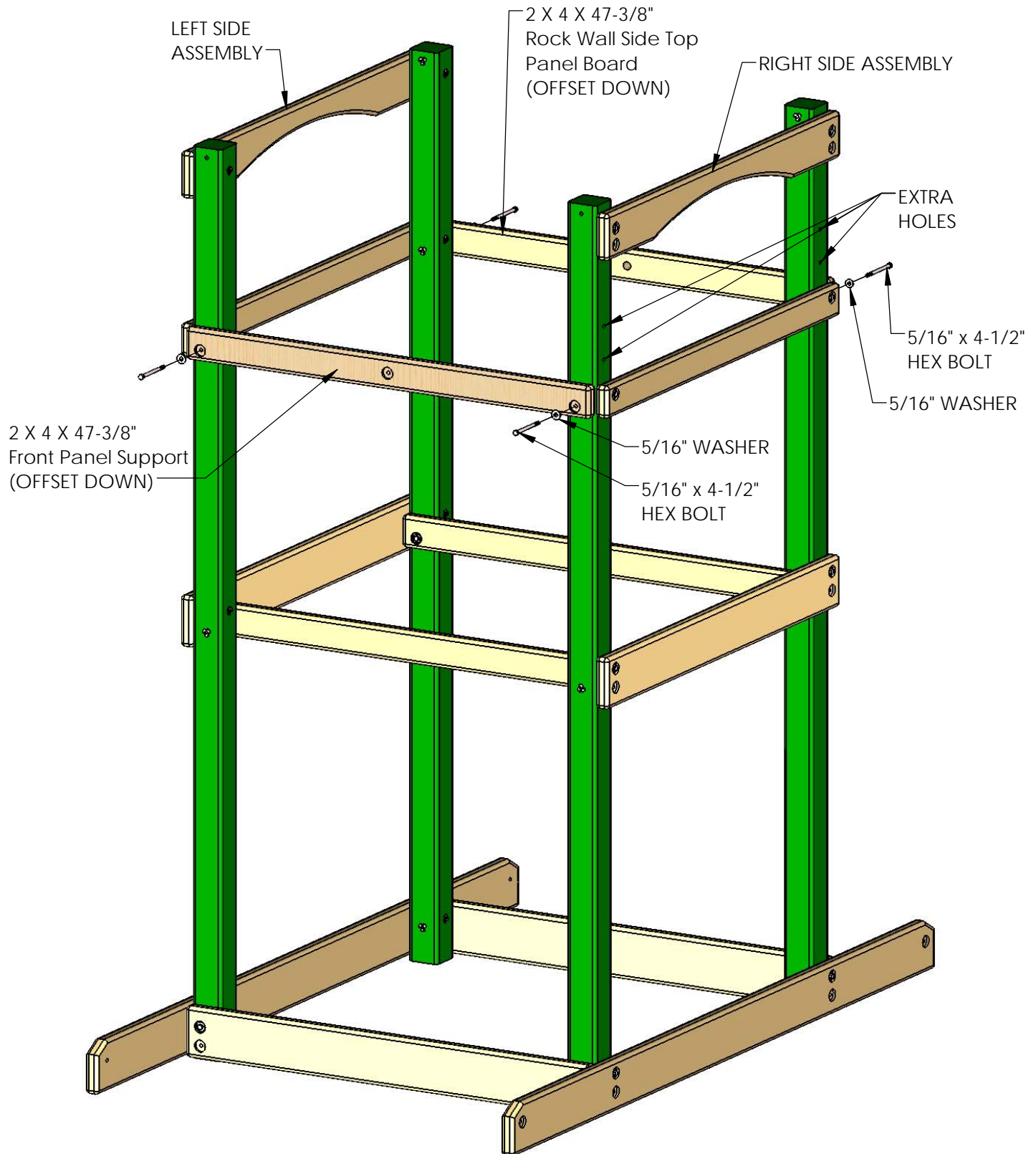

## STEP 7: FORT SUPPORTS

- 1: Place a 5/16" T-Nut into the hole in the Fort Supports as shown.
  - 2: From the inside of the Outrigger loosely attach each Fort Support with one 5/16" x 2-1/2" hex bolt and one 5/16" washer.
  - 3: Measure 2" and 3-1/2" down from the tip of each fort support and drill a 1/8" hole through the Fort Support along the center. (see Detail A)
- Use a carpenters square and level to ensure the fort is plumb and square before proceeding. The set should be in its final position when you do this. Refer to the leveling instructions at the beginning of the manual for reference.
- 4: Place each Fort Support againsts the corner post. The side of the Fort Support should be flush with the side of the corner post.
  - 5: Attach the angled end of each Fort Support with one 2-1/2" wood screw and one 3" wood screw. Tighten each 5/16" x 2-1/2" hex bolt.

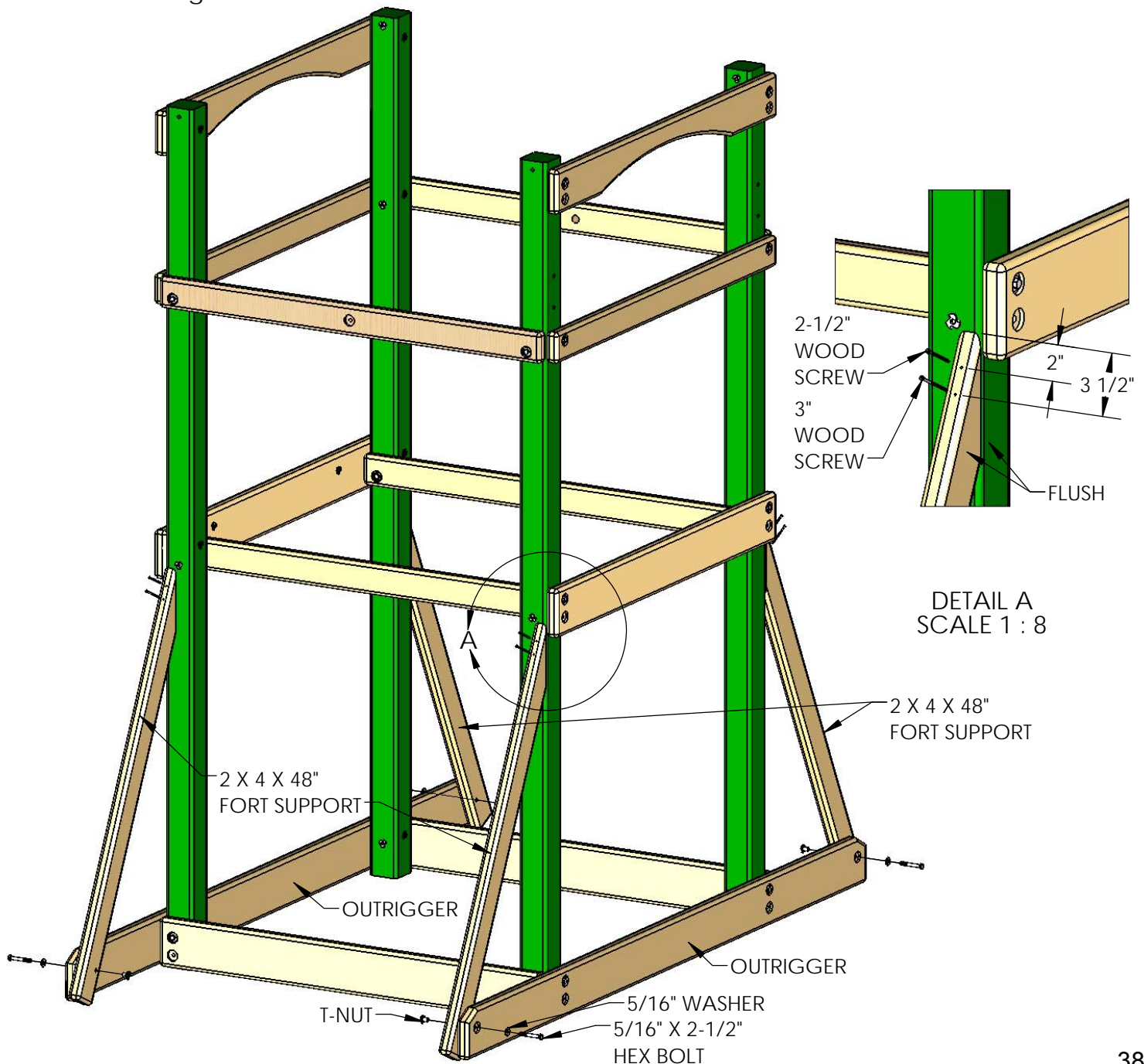

## STEP 8: DECK SPACERS

1: PLACE A 5/4 X 4 X 40-1/4" DECK SPACER BETWEEN THE LEFT AND RIGHT CORNER POSTS ON TOP OF THE DECK SUPPORTS AS SHOWN BELOW.

2: THE DECK SPACER SIDE SHOULD BE FLUSH WITH THE INSIDE OF THE BOTTOM PANEL BOARD.

3: ATTACH EACH DECK SPACER TO THE DECK SUPPORTS WITH TWO 2" WOOD SCREWS.

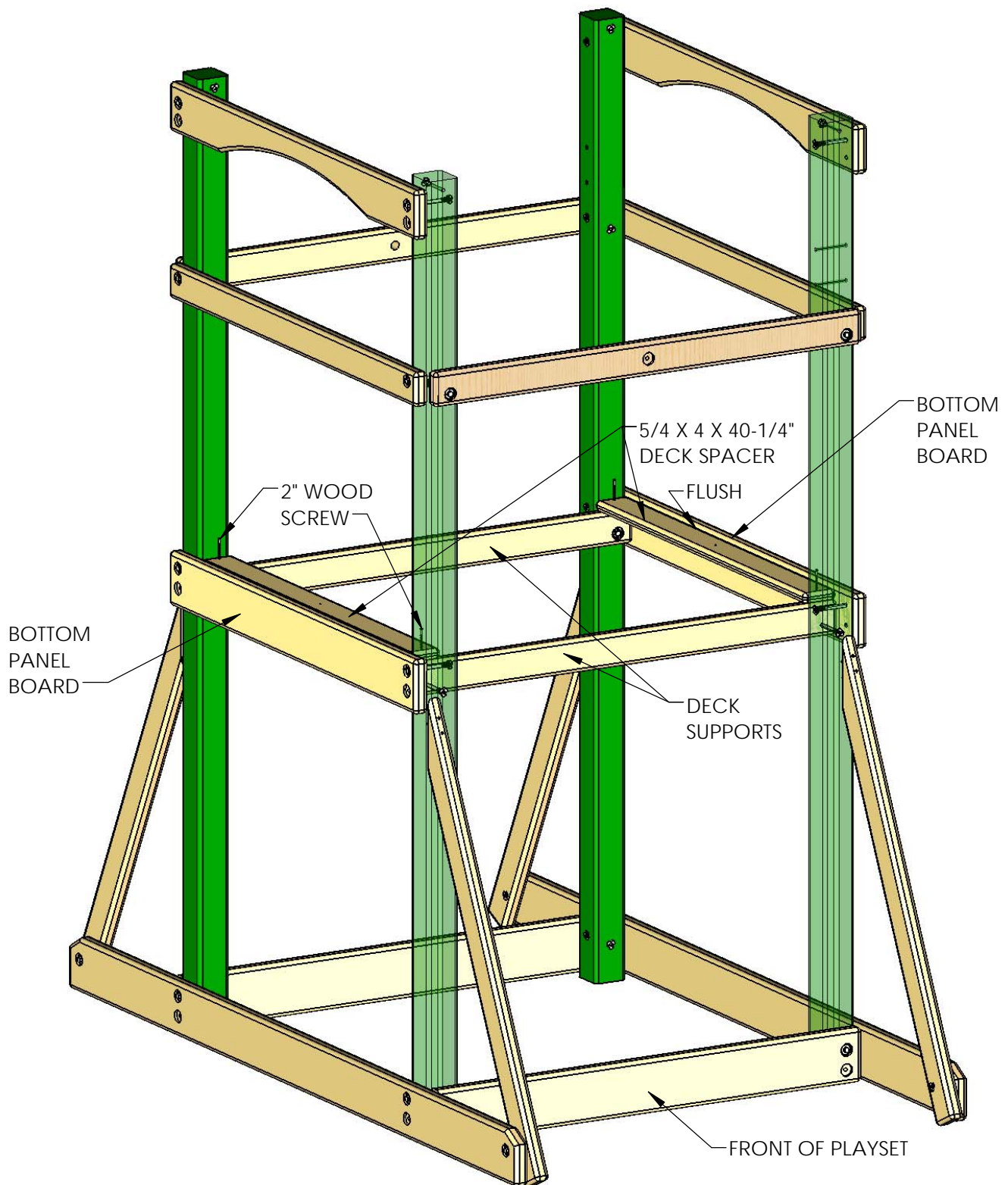

# STEP 9: ANGLE SUPPORTS

**\*IMPORTANT\*** - THE TOP OF EACH "Q" ANGLE SUPPORT MAY NOT EXTEND ABOVE THE TOP OF THE DECK SUPPORT OR IT WILL INTERFERE WITH THE DECK BOARDS INSTALLED LATER. (DETAIL A)  
 LAY A DECK BOARD ACROSS THE DECK SUPPORTS BEFORE INSTALLING THE "Q" ANGLE SUPPORTS

1: FOUR 2 X 4 X 13" ANGLE SUPPORTS ARE MOUNTED UNDERNEATH THE DECK ON THE FRONT AND REAR SIDES OF THE FORT. (THESE ARE CALLED OUT BY THE LETTER "Q")

2: ATTACH EACH ANGLE SUPPORT (Q) TO THE DECK SUPPORT WITH TWO 2-1/2" WOOD SCREWS AT THE TOP GOING THROUGH THE ANGLE SUPPORT (Q) FIRST AND THEN INTO THE DECK SUPPORT. ATTACH THE BOTTOM OF THE ANGLE SUPPORT (Q) TO THE CORNER POST WITH ONE 2" WOOD SCREW AND ONE 3" WOOD SCREW.

3: FOUR 2 X 4 X 13" ANGLE SUPPORTS ARE MOUNTED UNDERNEATH THE DECK SPACERS ON THE LEFT AND RIGHT OF THE FORT. THESE ARE CALLED OUT BY THE LETTER "X". (DETAIL B)

4: ATTACH EACH ANGLE SUPPORT (X) TO THE BOTTOM PANEL BOARD WITH TWO 2-1/2" WOOD SCREWS AT THE TOP GOING THROUGH THE ANGLE SUPPORT (X) INTO THE BOTTOM PANEL BOARD. ATTACH THE BOTTOM OF THE ANGLE SUPPORT (X) TO THE CORNER POST WITH ONE 2" WOOD SCREW AND ONE 3" WOOD SCREW.

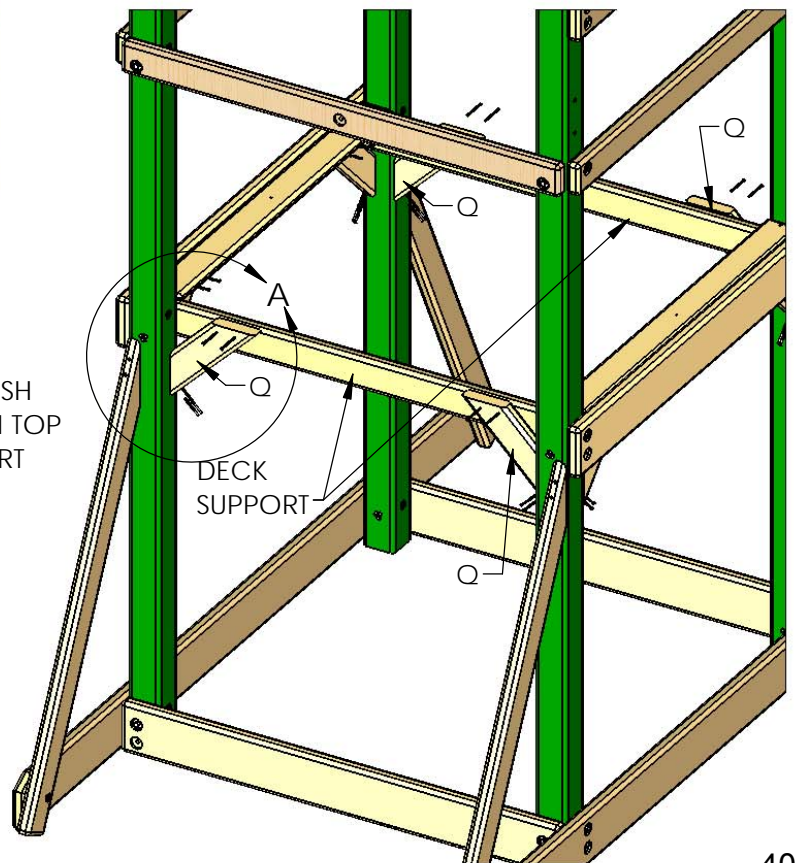
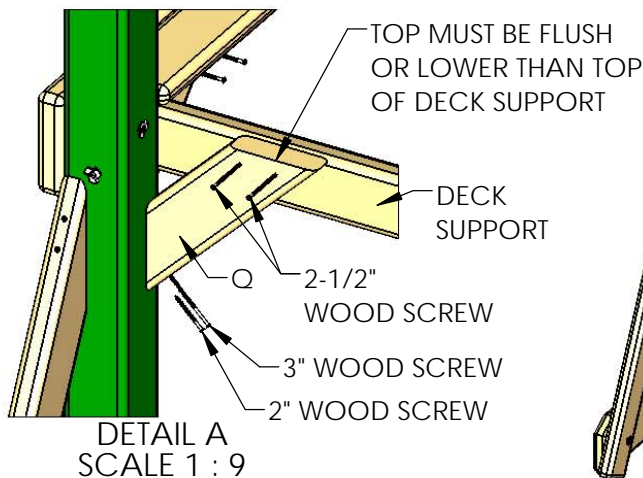
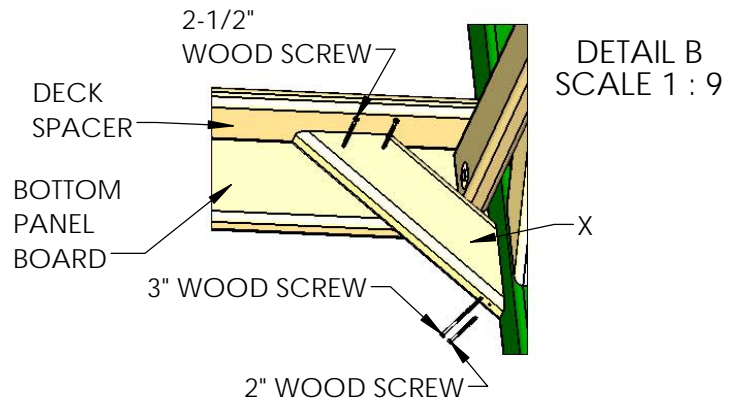
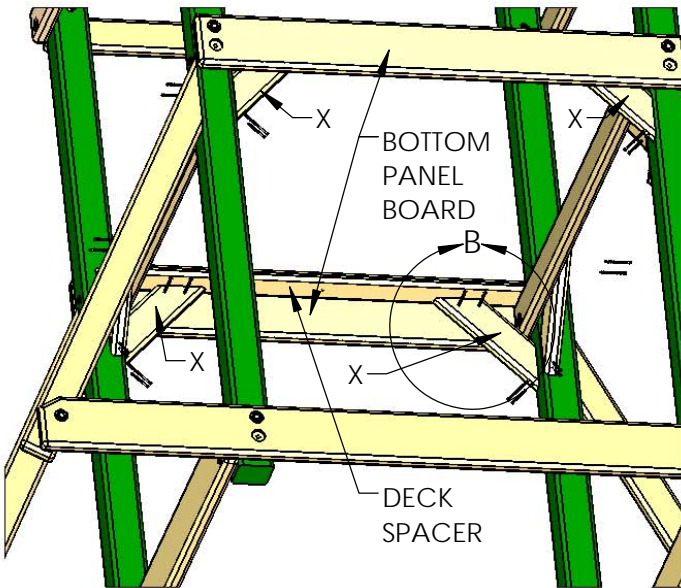



## STEP 10: LAG SCREWS

1: CHECK ONCE AGAIN TO ENSURE YOUR PLAY SET FRAME IS LEVEL SIDE TO SIDE AND FRONT TO BACK. CHECK THE DIAGONALS FOR SQUARE. ONCE YOU HAVE A LEVEL AND SQUARE PLAY SET FRAME YOU MAY INSTALL THE LAG SCREWS.

2: INSTALL ONE 5/16" X 3-1/2" LAG SCREW WITH 5/16" WASHER INTO THE EMPTY HOLES IN ALL OF THE 2 X 6 BOARDS.

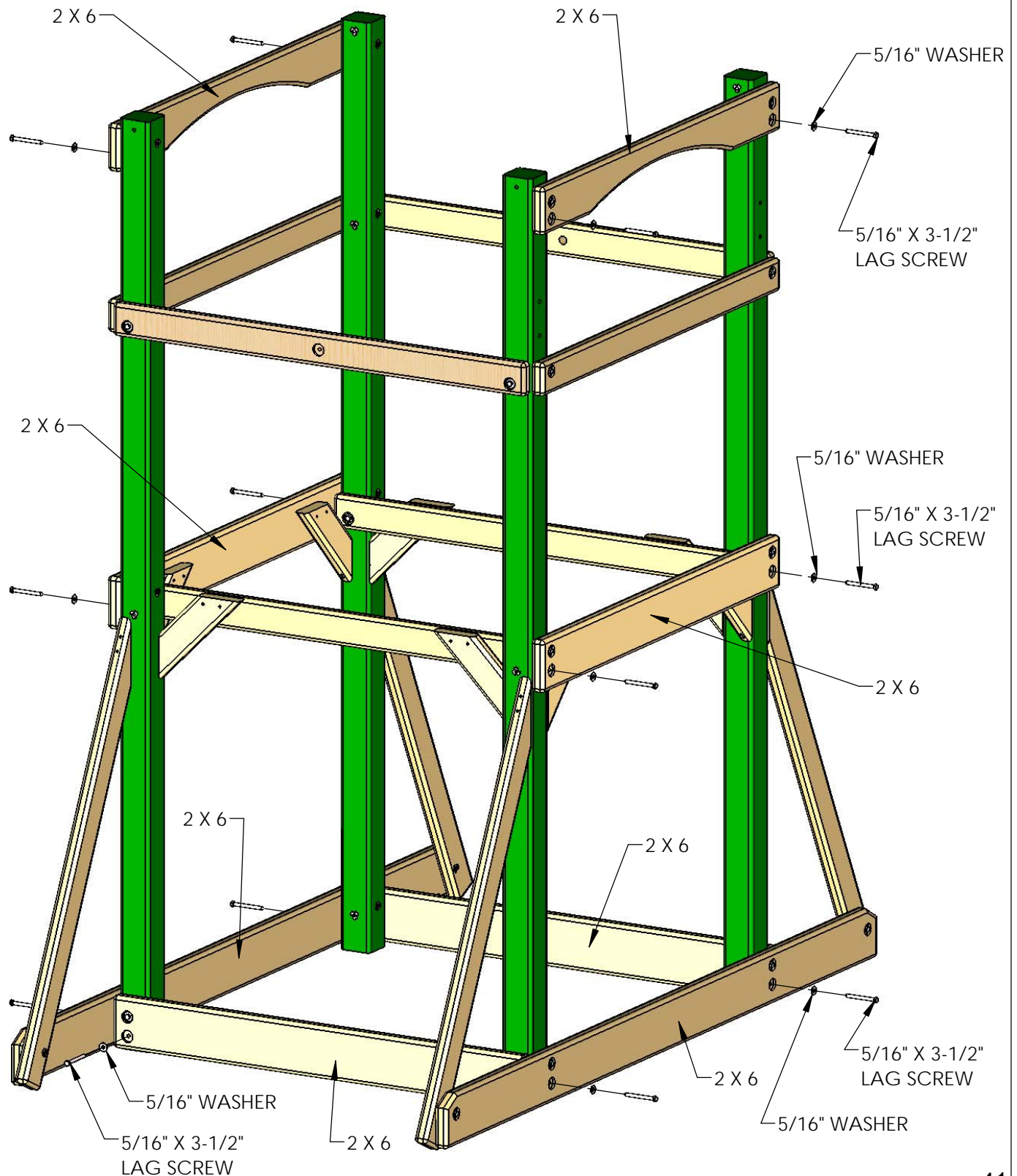

# STEP 11: INGROUND MOUNTS

IN THE NEXT STEPS YOU WILL BE DIGGING HOLES AND INSTALLING THE FOUR 2 X 4 X 31" INGROUND MOUNTS PRIOR TO MIXING CONCRETE. EACH MOUNT WILL REQUIRE A HOLE 26" DEEP OR SLIGHTLY MORE.

EACH MOUNT WILL BE LOCATED 4-1/2" FROM THE END OF THE OUTRIGGER. EACH MOUNT WILL BE ON THE INSIDE OF THE OUTRIGGER.

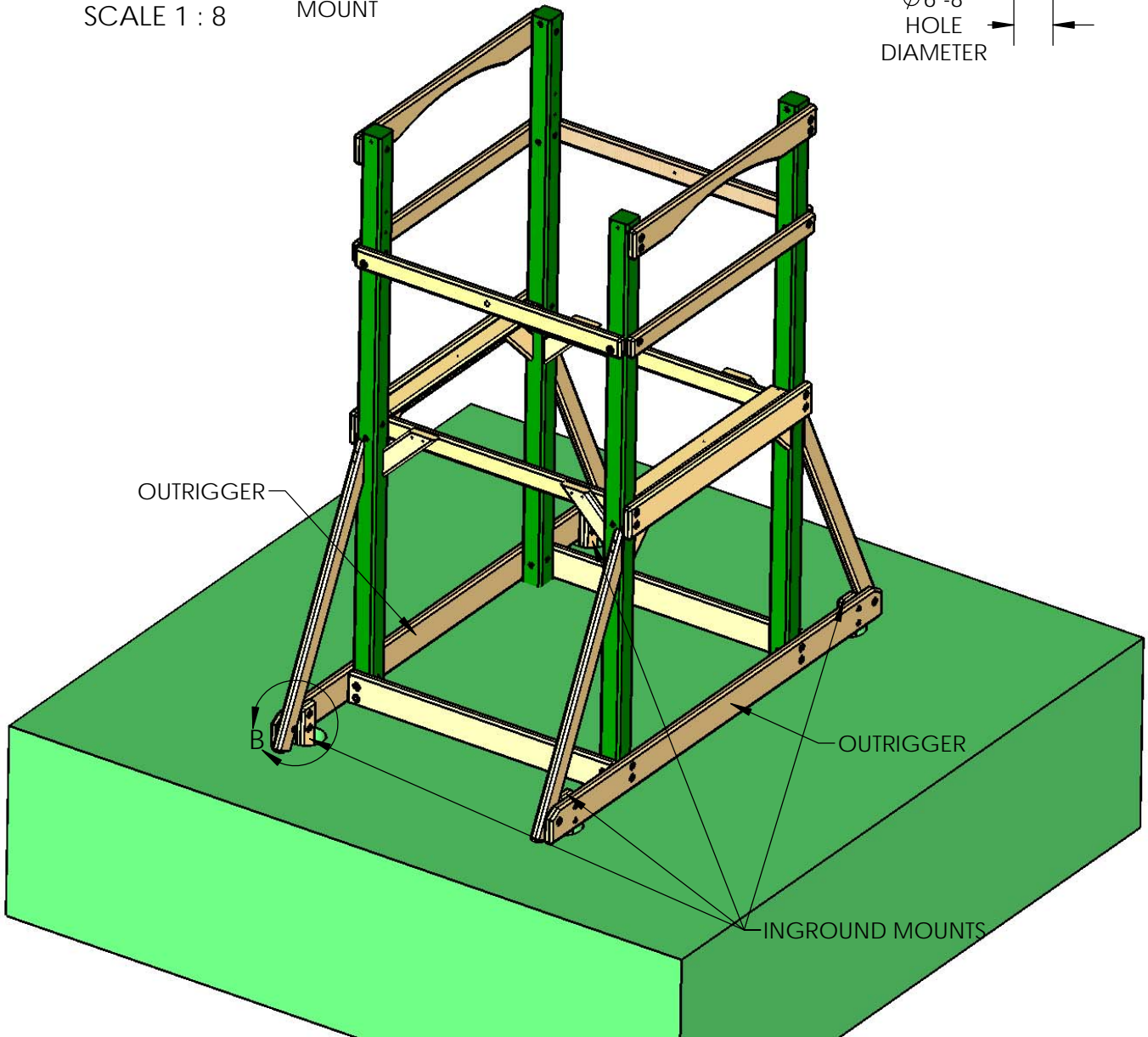
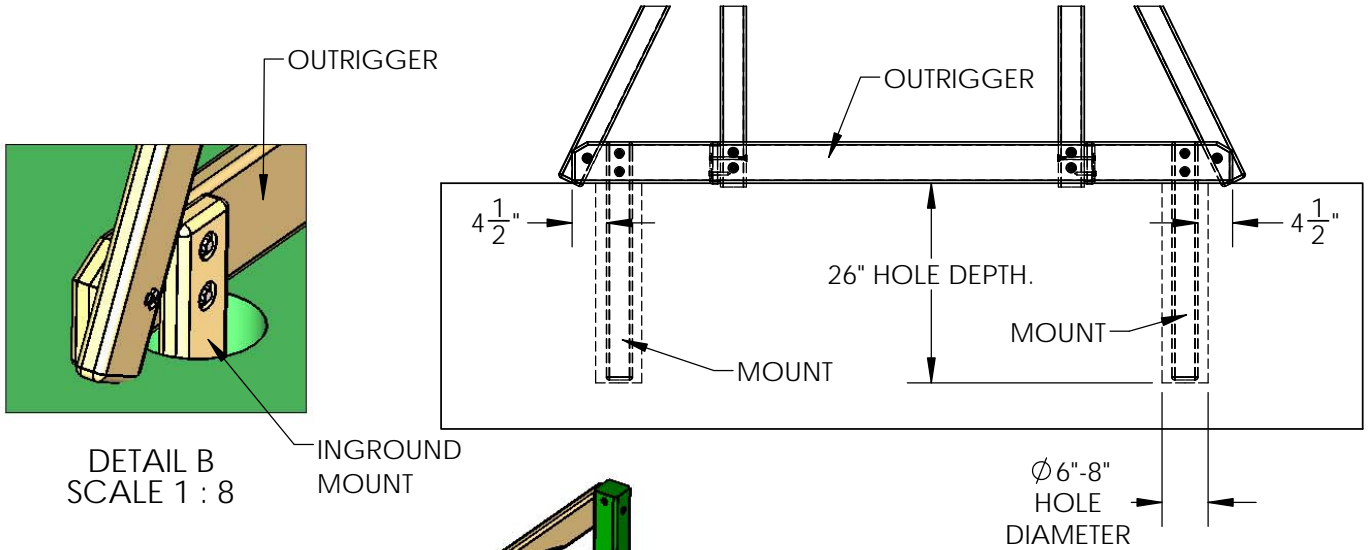

## STEP 12: INGROUND MOUNTS (CONTINUED)

1: MEASURE 4-1/2" FROM THE END OF EACH OUTRIGGER AND MARK THE GROUND BENEATH IT WHERE THE INGROUND MOUNT WILL BE LOCATED.

2: HAVE AN ASSISTANT HELP YOU LIFT AND LOCATE THE PLAYSET AWAY FROM THE DIGGING AREA.

3: DIG FOUR HOLES ABOUT 28" DEEP.

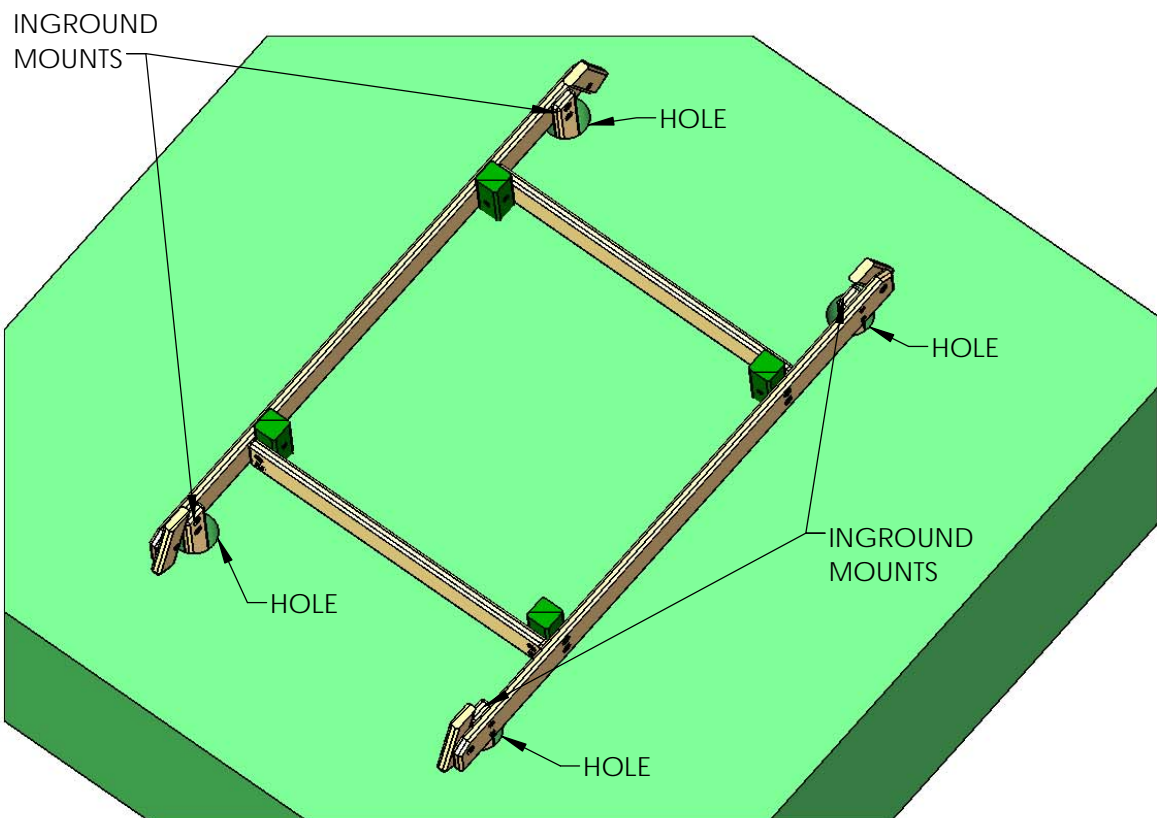
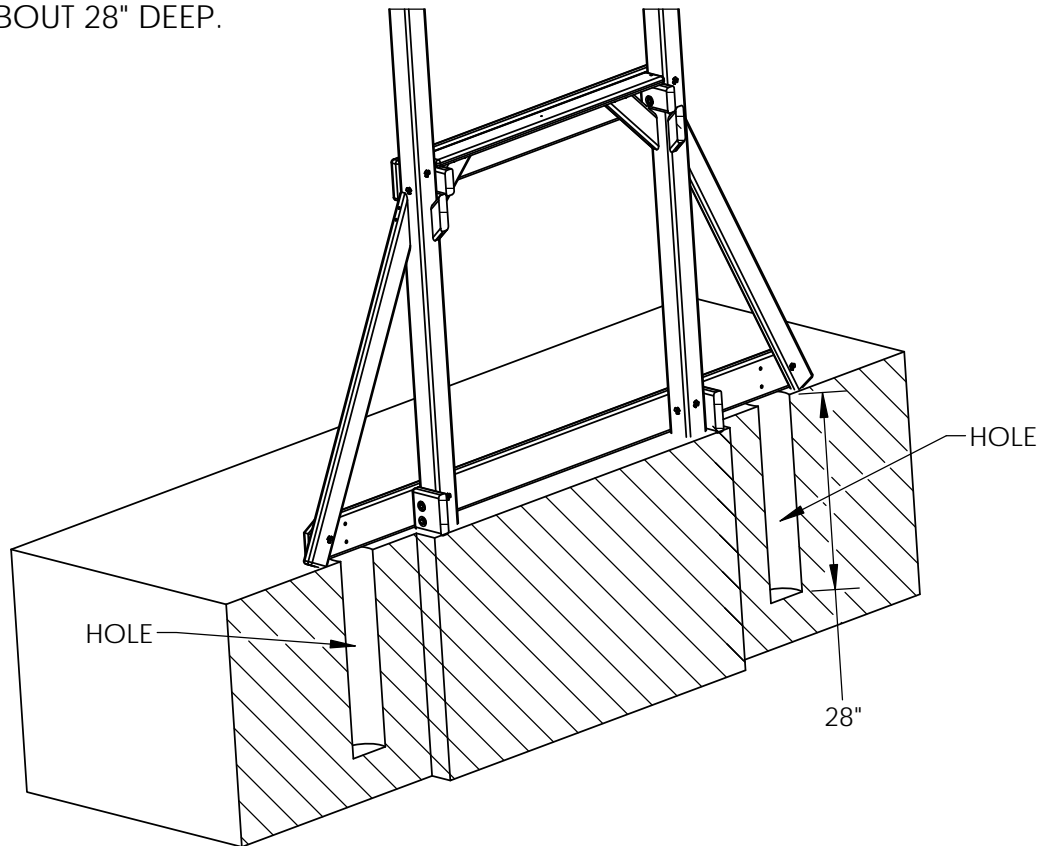

## STEP 13: INGROUND MOUNTS CONTINUED

YOU AND YOUR ASSISTANT MAY NOW MOVE THE PLAYSET BACK INTO THE ORIGINAL POSITION.

1: PLACE THE 2 X 4 X 31" INGROUND MOUNT INTO THE HOLE. MAKE THE TOP FLUSH TO THE TOP OF THE OUTRIGGER. MAKE THE SIDE 4-1/2" IN FROM THE END OF THE OUTRIGGER. USE A 3/8" DRILL BIT AND THE MOUNT AS A DRILL GUIDE TO DRILL 3/8" HOLES INTO THE OUTRIGGER.

2: HAMMER TWO 5/16" T-NUTS INTO THE HOLES IN THE OUTRIGGER. PLACE THE INGROUND MOUNT AGAINST THE OUTRIGGER AND SECURE IT WITH TWO 5/16" X 2-1/2" HEX BOLTS WITH 5/16" WASHERS.

3: REPEAT SUBSTEPS 1-2 FOR THE REMAINING THREE INGROUND MOUNTS.

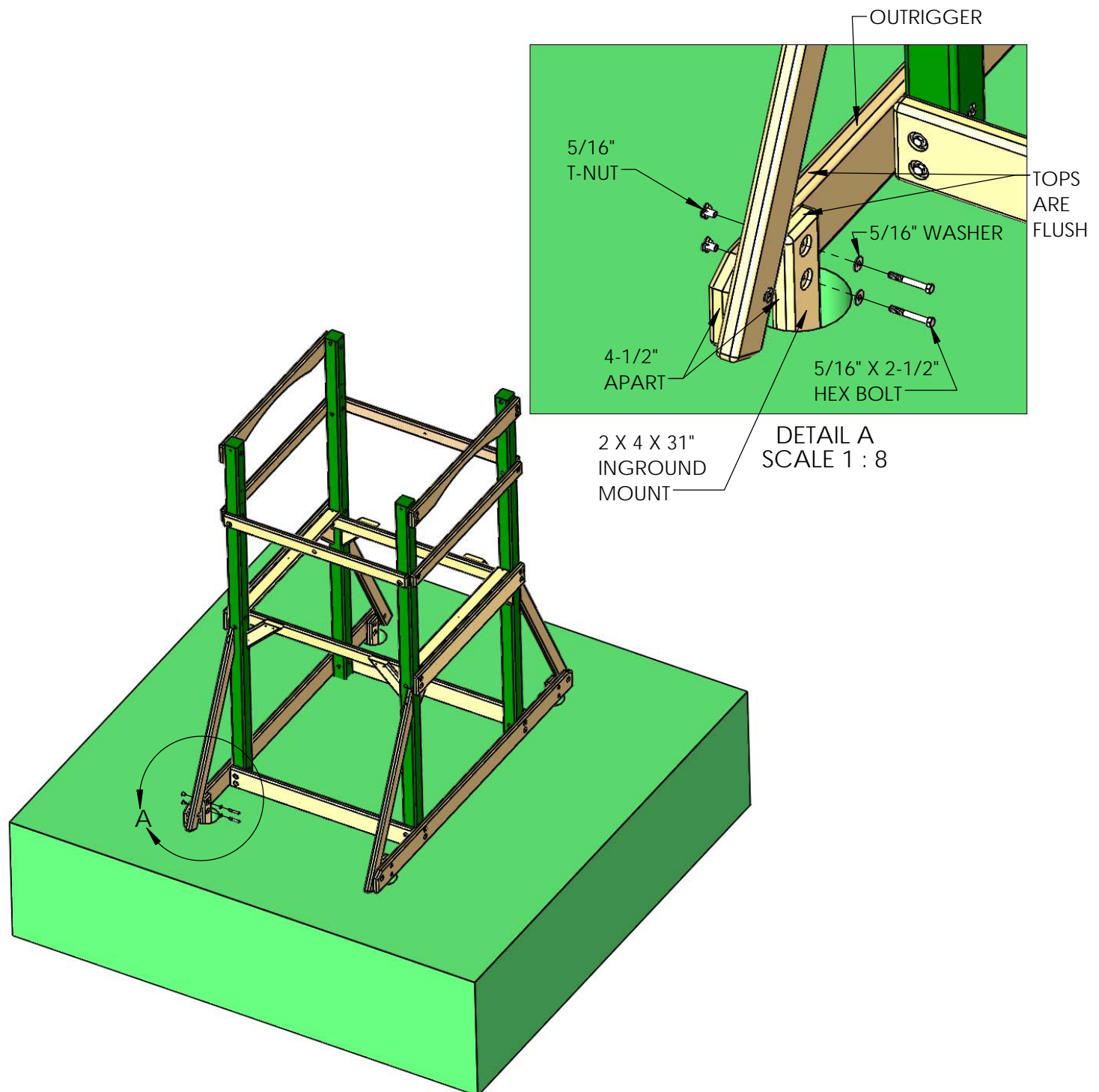

## STEP 14: INGROUND MOUNTS CONTINUED

- 1: YOU WILL NEED APPROXIMATELY ONE 60 LB BAG OF CONCRETE PER HOLE. THIS CALCULATION IS BASED UPON AN 8" DIAMETER HOLE THAT IS 28" DEEP. SO IF YOUR HOLE IS LARGER THAN 8" AND DEEPER THAN 28" THEN YOU WILL NEED MORE CONCRETE. TO BE ON THE SAFE SIDE PURCHASE 6 BAGS. YOU CAN RETURN WHAT YOU DO NOT USE.
- 2: MIX THE CONCRETE ACCORDING TO THE MANUFACTURER'S DIRECTIONS. FILL EACH HOLE SO THE TOP OF THE CONCRETE IS 1" BELOW THE SURFACE OF THE DIRT.
- 3: WHEN THE CONCRETE IS DRY COME BACK AND PUT DIRT OVER THE TOP.

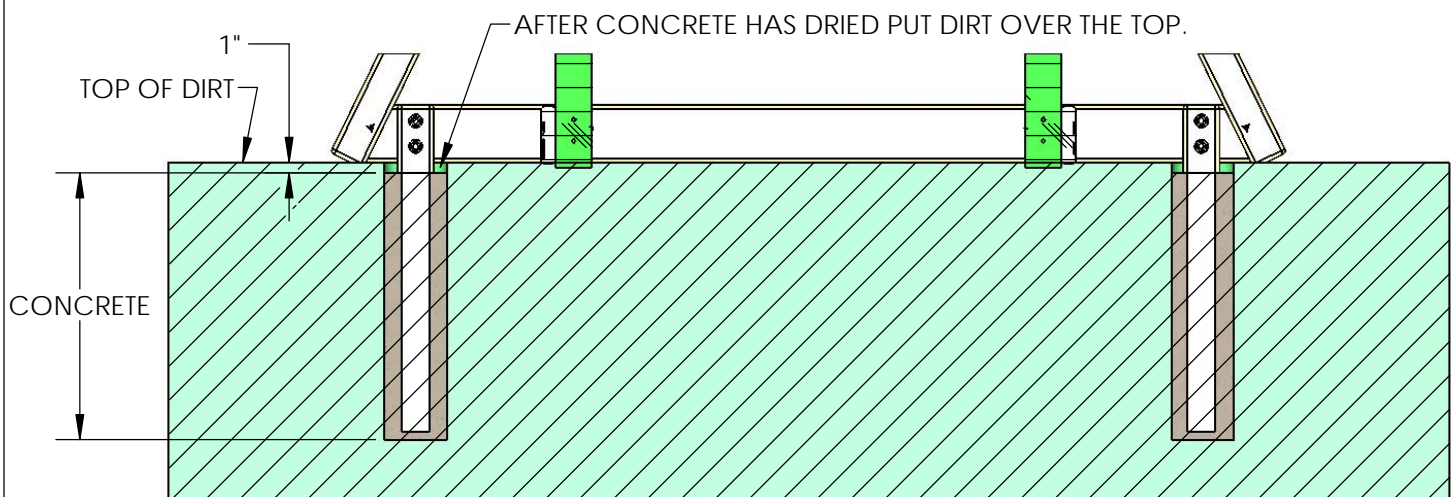
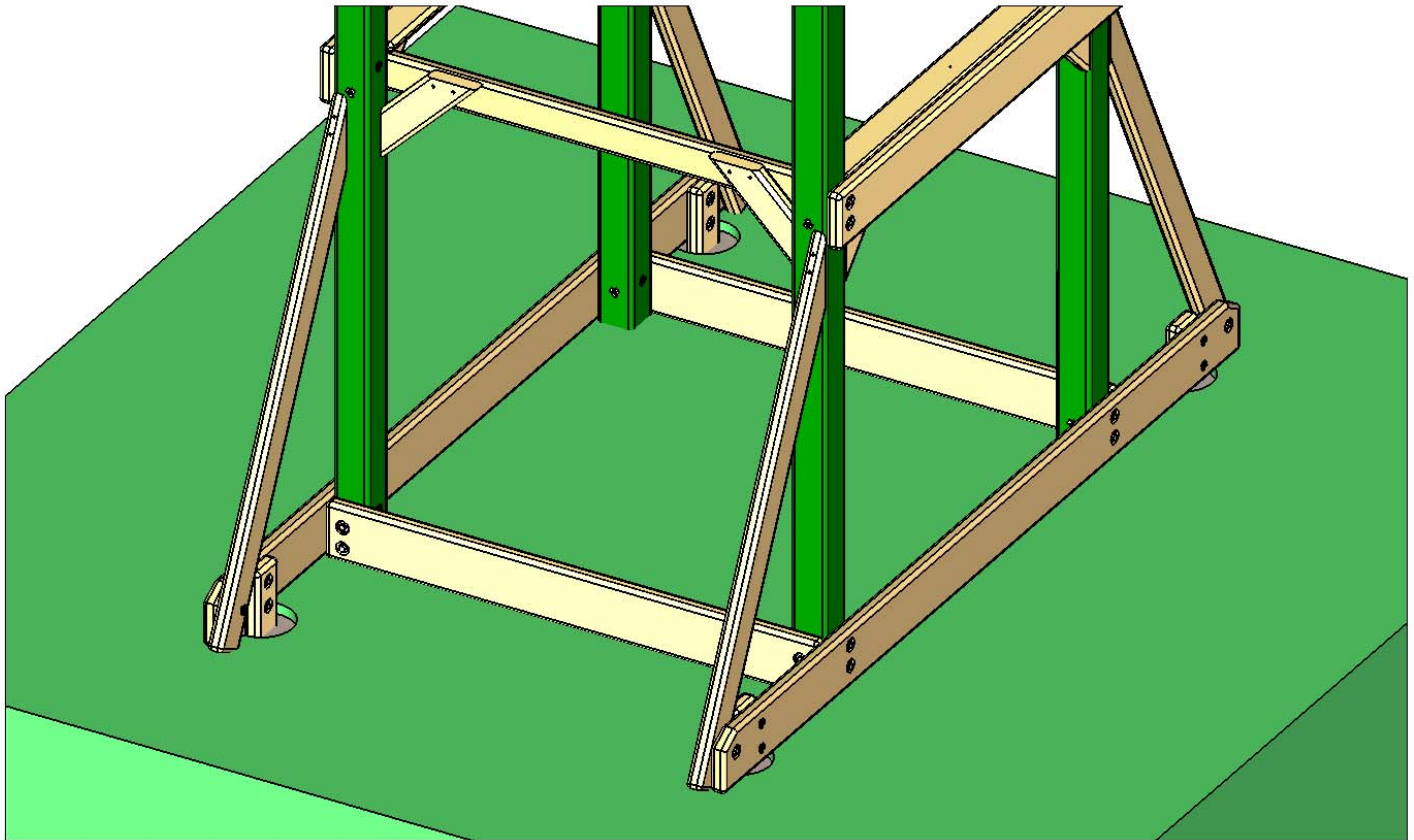

## STEP 15: DECK STRINGER

- 1: PLACE THE 2 X 4 X 47-3/8" DECK STRINGER CENTERED UNDERNEATH THE DECK SPACERS.
- 2: ATTACH THE DECK STRINGER TO THE DECK SPACERS WITH TWO 2" WOOD SCREWS.

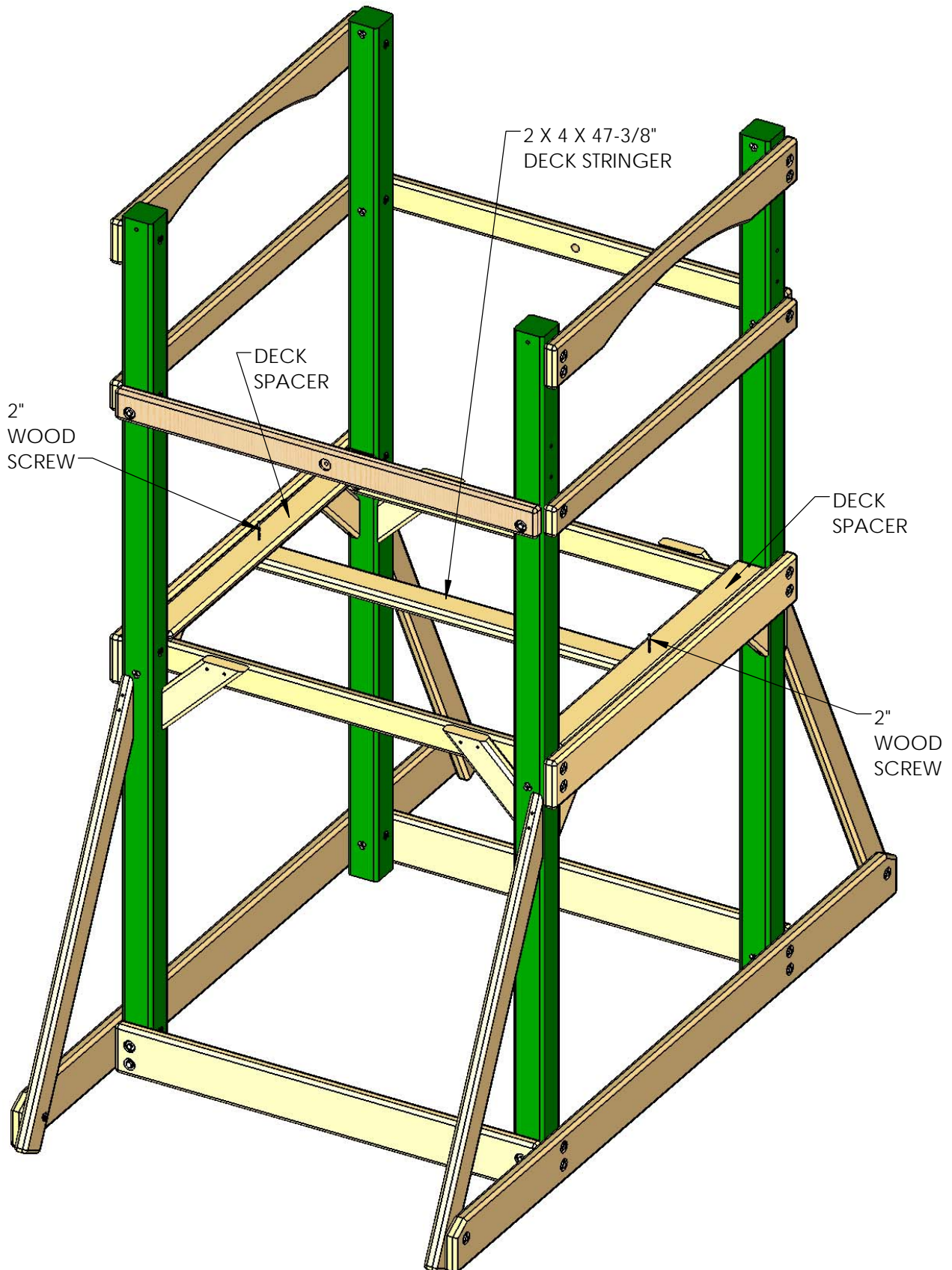

## STEP 16: ROCK WALL

1: LOCATE TWO 2 X 4 X 57" ROCK WALL SIDE BOARDS. LAY THE BOARDS OUT AS SHOWN AND INSERT A 5/16" T-NUT INTO THE HOLE ON THE INSIDE OF EACH BOARD. USE A HAMMER TO SET EACH T-NUT FLUSH WITH THE BOARD.

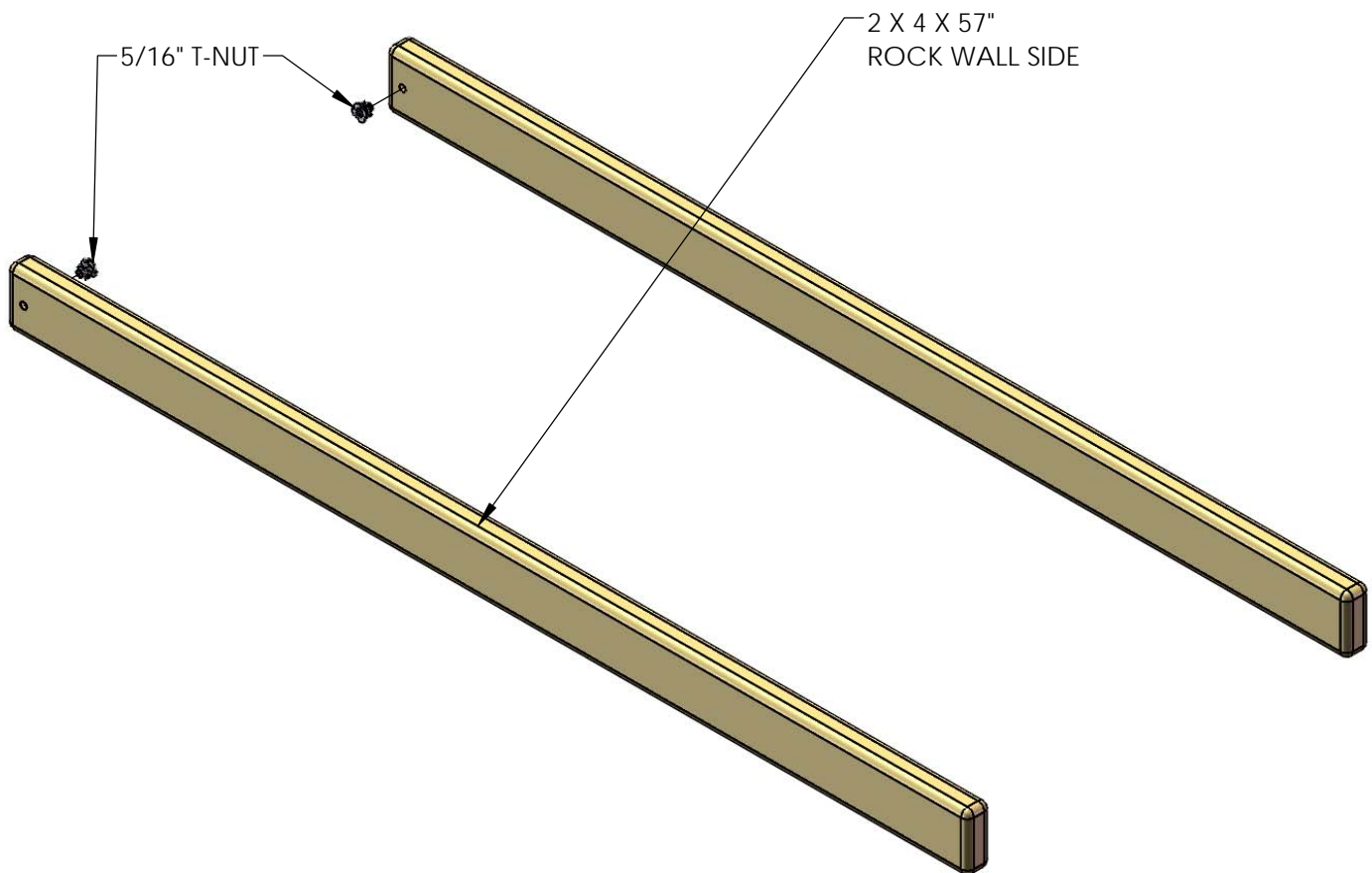

## STEP 17: ROCK WALL

- 1: LOCATE TEN 5/4 X 5 X 23-7/8" ROCK WALL BOARDS AND ONE 5/4 X 5 X 23-7/8" BOTTOM ROCK WALL BOARD WITH ONE BIG HOLE IN IT.
- 2: PLACE ONE ROCK WALL BOARD AT THE TOP OF THE ROCK WALL SIDES NEAREST THE HOLES WHERE YOU PREVIOUSLY INSTALLED THE T-NUTS. MAKE SURE THE ROCK WALL BOARD IS FLUSH WITH THE ENDS AND SIDES OF THE ROCK WALL SIDE BOARDS.
- 3: ATTACH THE ROCK WALL BOARD WITH FOUR 2" WOOD SCREWS.
- 4: NOW PLACE ANOTHER ROCK WALL BOARD BENEATH THE PREVIOUSLY INSTALLED BOARD AND ATTACH IT WITH FOUR 2" WOOD SCREWS. CONTINUE INSTALLING ROCK WALL BOARDS TO THE ROCK WALL SIDES UNTIL THEY ARE USED UP.
- 5: ATTACH THE BOTTOM ROCK WALL BOARD WITH ONE LARGE HOLE IN IT LAST WITH FOUR 2" WOOD SCREWS. THE LARGE HOLE SHOULD BE OFFSET UP.

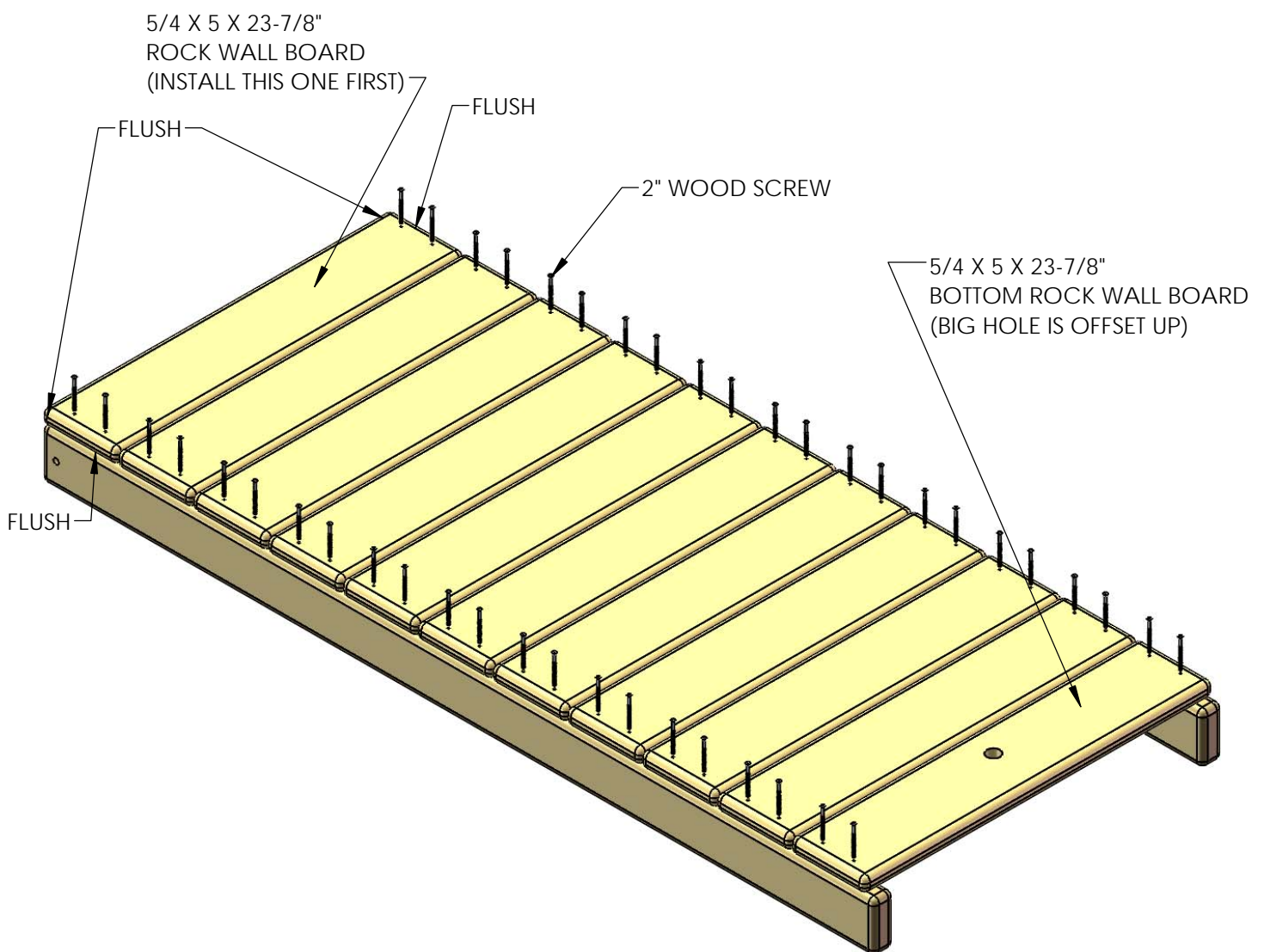



## STEP 18: ROCK WALL

1: LOCATE TWO 90° GREEN BRACKETS, TWO 5/16" WASHERS AND TWO 5/16" X 1-1/2" HEX BOLTS.

2: FASTEN THE TAPERED SIDE OF EACH 90° BRACKET TO EACH ROCK WALL SIDE WITH A 5/16" X 1-1/2" HEX BOLT AND A 5/16" WASHER.

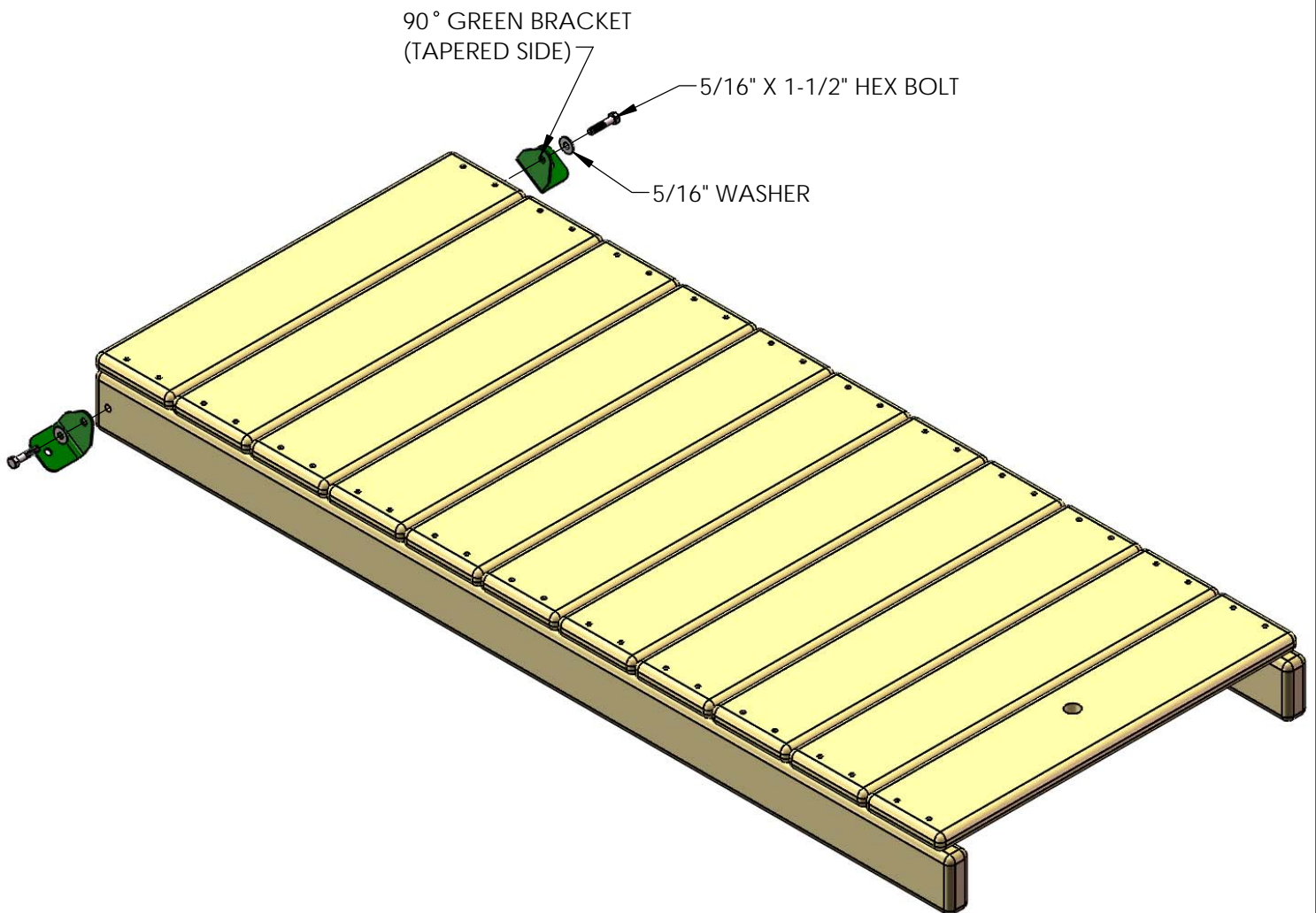

## STEP 19: ROCK WALL

1: LOCATE TWO BAGS OF CLIMBING ROCKS. INSIDE EACH BAG SHOULD BE FIVE ROCKS, FIFTEEN #14 X 1-1/4" PAN HEAD SCREWS AND FIFTEEN 1/4" FLAT WASHERS.

2: PLACE THE CLIMBING ROCKS IN A STAGGERED PATTERN ON THE ROCK WALL BOARDS. PLACE ONE ROCK ON EACH BOARD EXCEPT FOR THE BOTTOM ROCK WALL BOARD WITH THE HOLE IN IT.

3: ATTACH EACH CLIMBING ROCK WITH THREE #14 X 1-1/4" PAN HEAD SCREWS AND THREE 1/4" FLAT WASHERS.

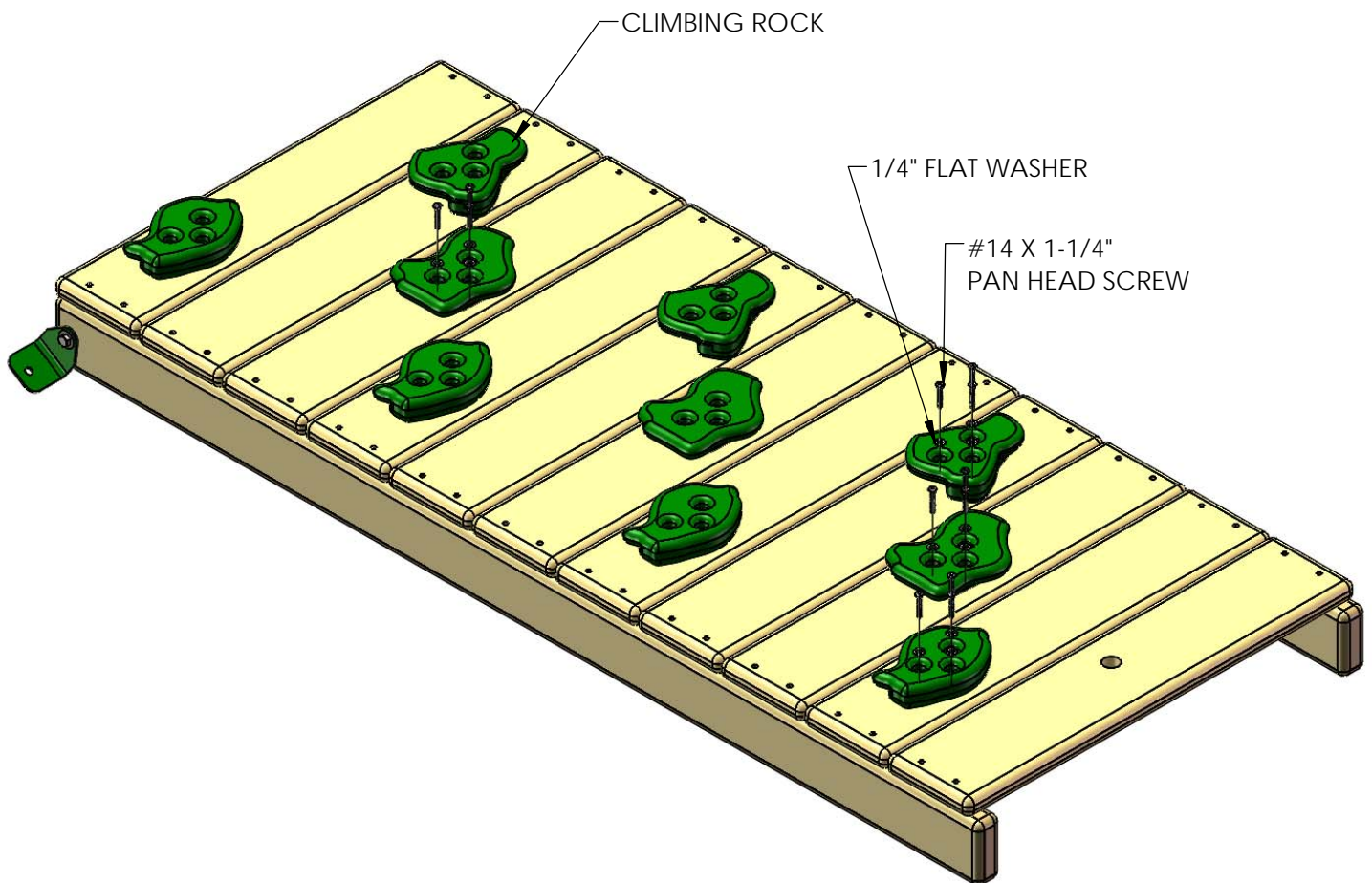

## STEP 20: ROCK WALL

1: PLACE THE 5/4 X 3 X 23-7/8" ROCK WALL TOP CAP ON TOP OF THE ROCK WALL SIDES FLUSH WITH THE TOP ROCK WALL BOARD.

2: FASTEN THE 5/4 X 3 X 23-7/8" ROCK WALL TOP CAP TO THE ROCK WALL SIDES AND THE TOP ROCK WALL BOARD WITH FOUR 2" WOOD SCREWS.

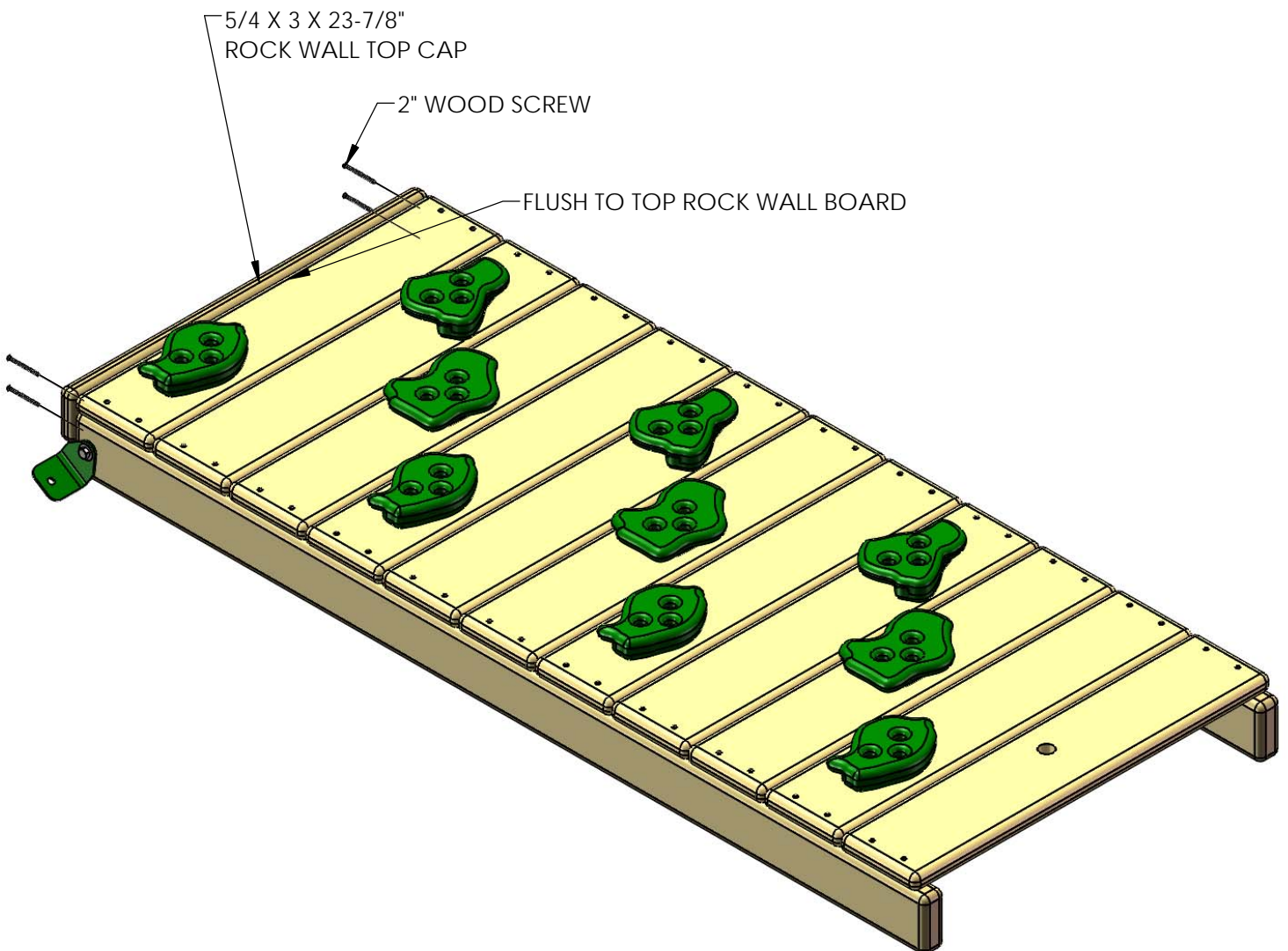

## STEP 21: ROCK WALL TO FACE BOARD

1: LAY THE 2 X 4 X 47-3/8" FACE BOARD ON A FLAT SURFACE AND PLACE THE ROCK WALL ON TOP OF IT. MAKE SURE THE LEFT SIDE OF THE ROCK WALL IS 11-3/4" FROM THE LEFT END OF THE FACE BOARD. THE BOTTOM EDGE OF THE 90° BRACKETS SHOULD BE 3/4" UP FROM THE BOTTOM EDGE OF THE 2 X 4. MARK THE POSITION OF THE BRACKET HOLES ON THE 2 X 4 AS SHOWN BELOW.

2: DRILL 3/8" HOLES WHERE MARKED.

3: INSERT 5/16" T-NUTS IN THE BACK OF THE HOLES.

4: ATTACH THE 90° BRACKETS TO THE 2 X 4 WITH TWO 5/16" X 1-1/2" HEX BOLTS AND TWO 5/16" WASHERS.

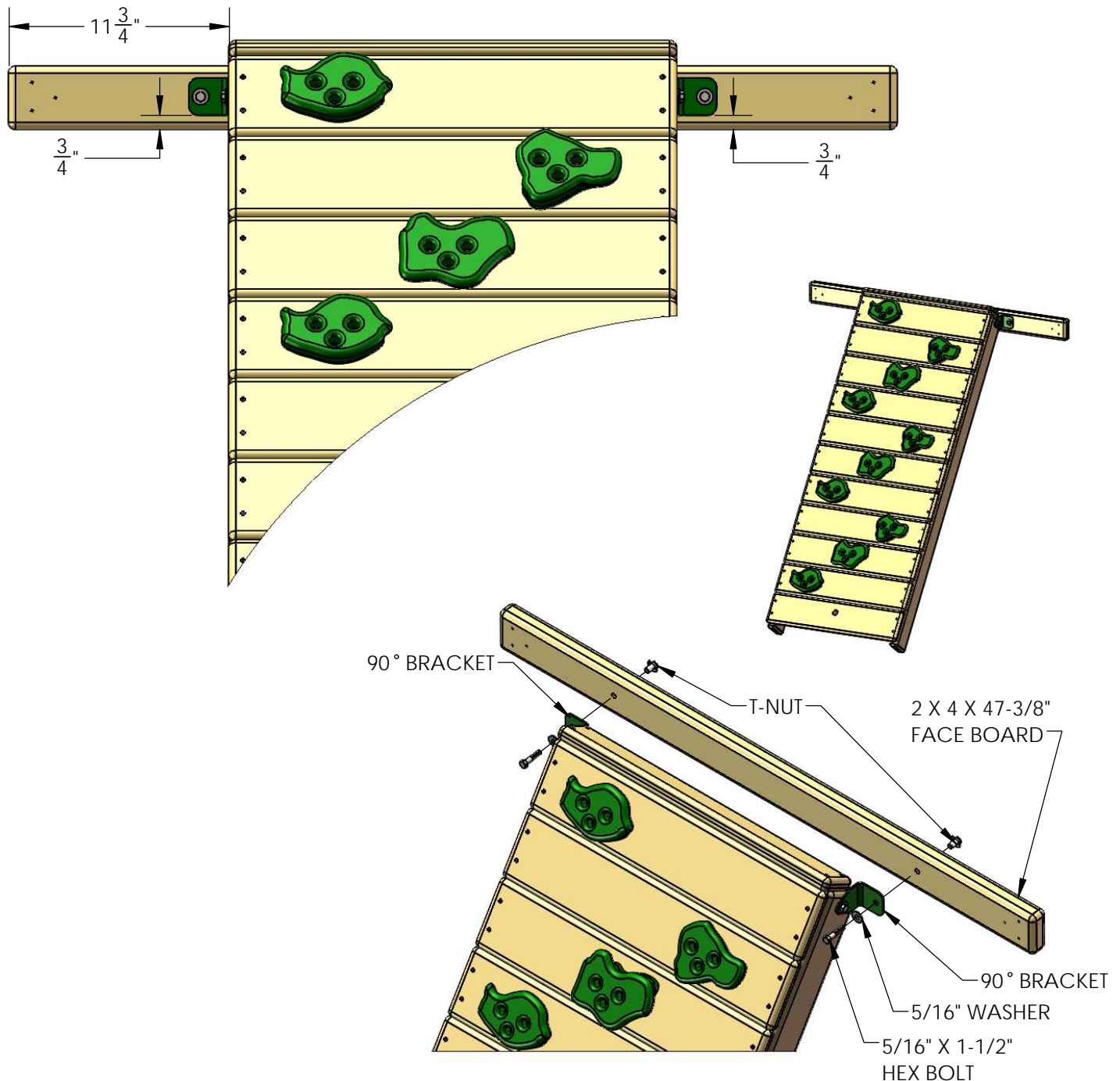

## STEP 22: ROCK WALL TO SET

1: PLACE THE FACE BOARD (WITH ROCK WALL) ONTO THE REAR OF THE PLAY SET MAKING SURE THE TOP OF THE BOARD IS FLUSH WITH THE TOP OF THE DECK SPACERS. CHECK THAT YOU ARE ON THE REAR OF THE SET BY LOOKING FOR THE "BIG HOLE" IN THE BOARD ABOVE THE ROCK WALL.

2: ATTACH THE FACE BOARD TO THE CORNER POSTS WITH SIX #8 X 2-1/2" WOOD SCREWS.

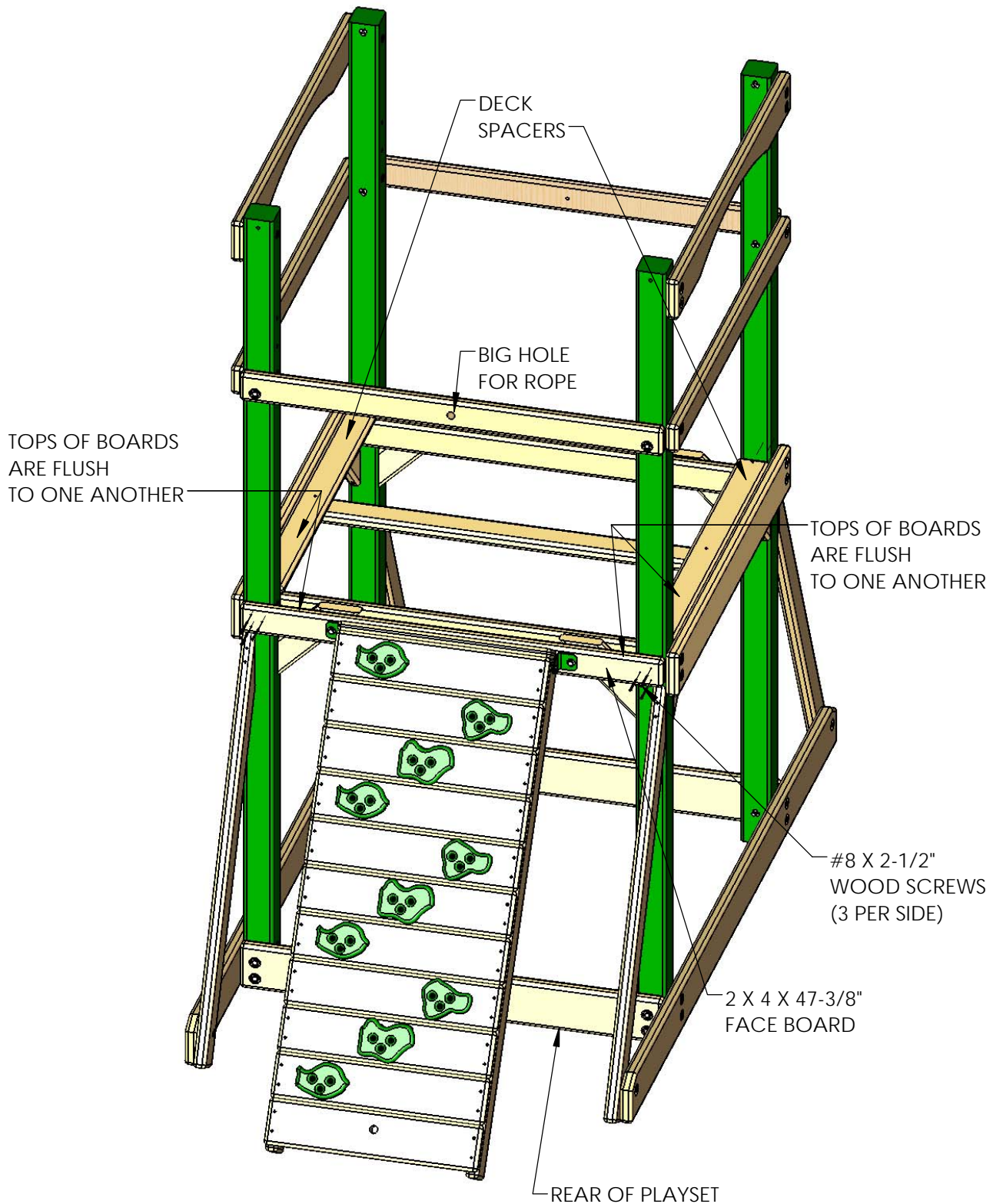

## STEP 23: LADDER

1: LAY ONE 2 X 4 X 57" LADDER SIDE ON A FLAT SURFACE WITH THE CHANNELS FACING DOWN. PLACE THE BARREL OF A T-NUT IN THE HOLE AT THE TOP OF THE LADDER SIDE, AND SECURE WITH A HAMMER. REPEAT THIS STEP FOR THE OTHER LADDER SIDE.

2: FLIP THE LADDER SIDE OVER SO THAT THE CHANNELS ARE FACING UP.

3: PLACE THE LADDER STEPS INTO THE CHANNELS, AND THEN PLACE THE SECOND LADDER SIDE ON TOP, WITH THE CHANNELS FACING DOWN.

4: NOW PLACE TWO 2" WOOD SCREWS IN EACH STEP.

5: CAREFULLY TURN THE LADDER OVER AND FINISH THE OTHER SIDE WITH TWO 2" WOOD SCREWS PER STEP.

6: INSTALL TWO 90° GREEN BRACKETS USING 5/16" X 1-1/2" BOLTS AND 5/16" WASHERS.

7: INSTALL THE 5/4 X 4 X 18-1/2" LADDER BACK ABOVE THE OPENING OF THE TOP CHANNELS WITH TWO 2" WOOD SCREWS PER SIDE.

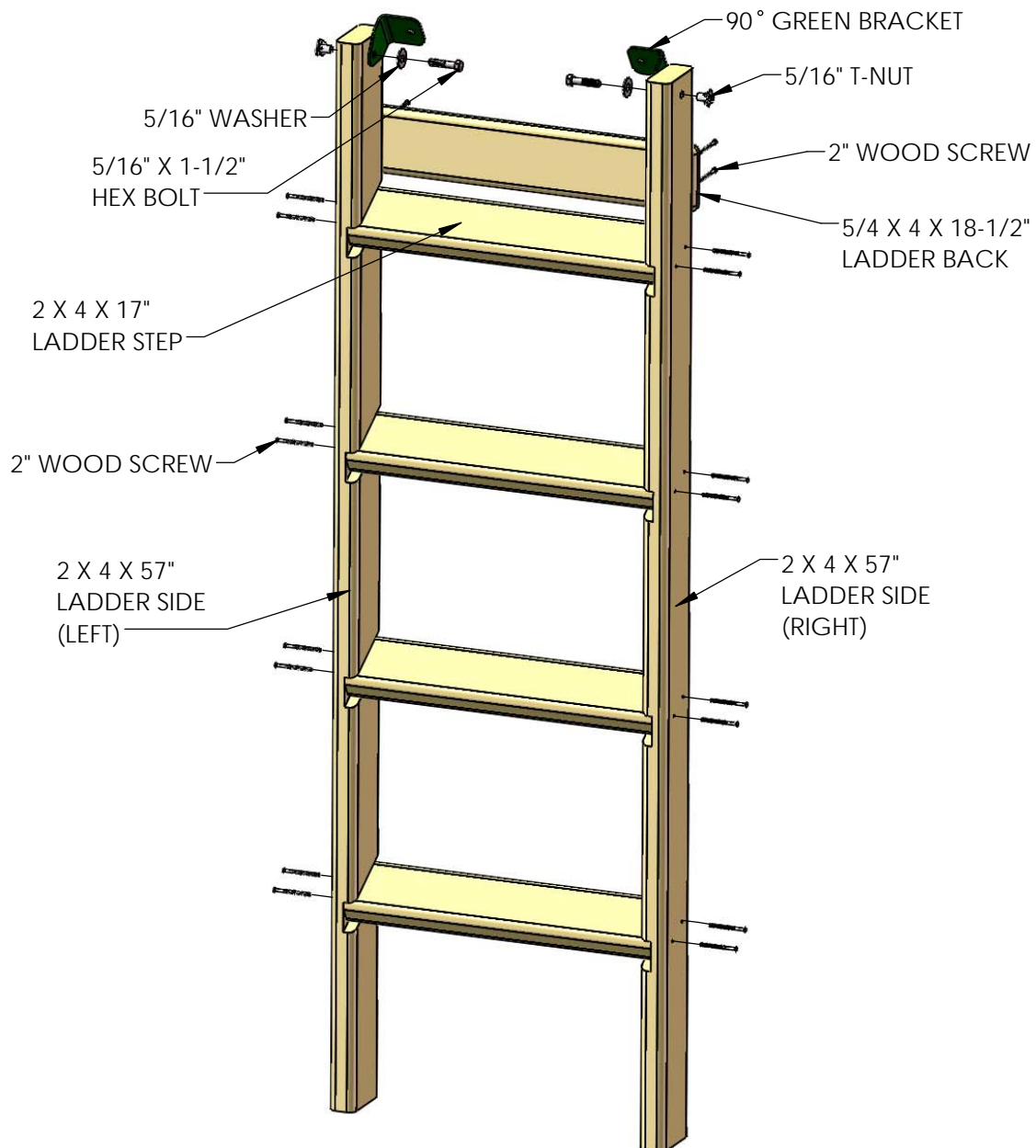

## STEP 24: LADDER TO FACE BOARD

1: LAY THE 2 X 4 X 47-3/8" FACE BOARD ON A FLAT SURFACE AND PLACE THE LADDER ON TOP OF IT. MAKE SURE THE LEFT SIDE OF THE LADDER IS 3-1/2" FROM THE LEFT END OF THE FACE BOARD. THE BOTTOM EDGE OF THE 90° BRACKETS SHOULD BE 3/4" UP FROM THE BOTTOM EDGE OF THE 2 X 4. MARK THE POSITION OF THE BRACKET HOLES ON THE 2 X 4 AS SHOWN BELOW.

2: DRILL 3/8" HOLES WHERE MARKED.

3: INSERT 5/16" T-NUTS IN THE BACK SIDE OF THE HOLES.

4: ATTACH THE 90° BRACKETS TO THE 2 X 4 WITH TWO 5/16" X 1-1/2" HEX BOLTS AND TWO 5/16" WASHERS.

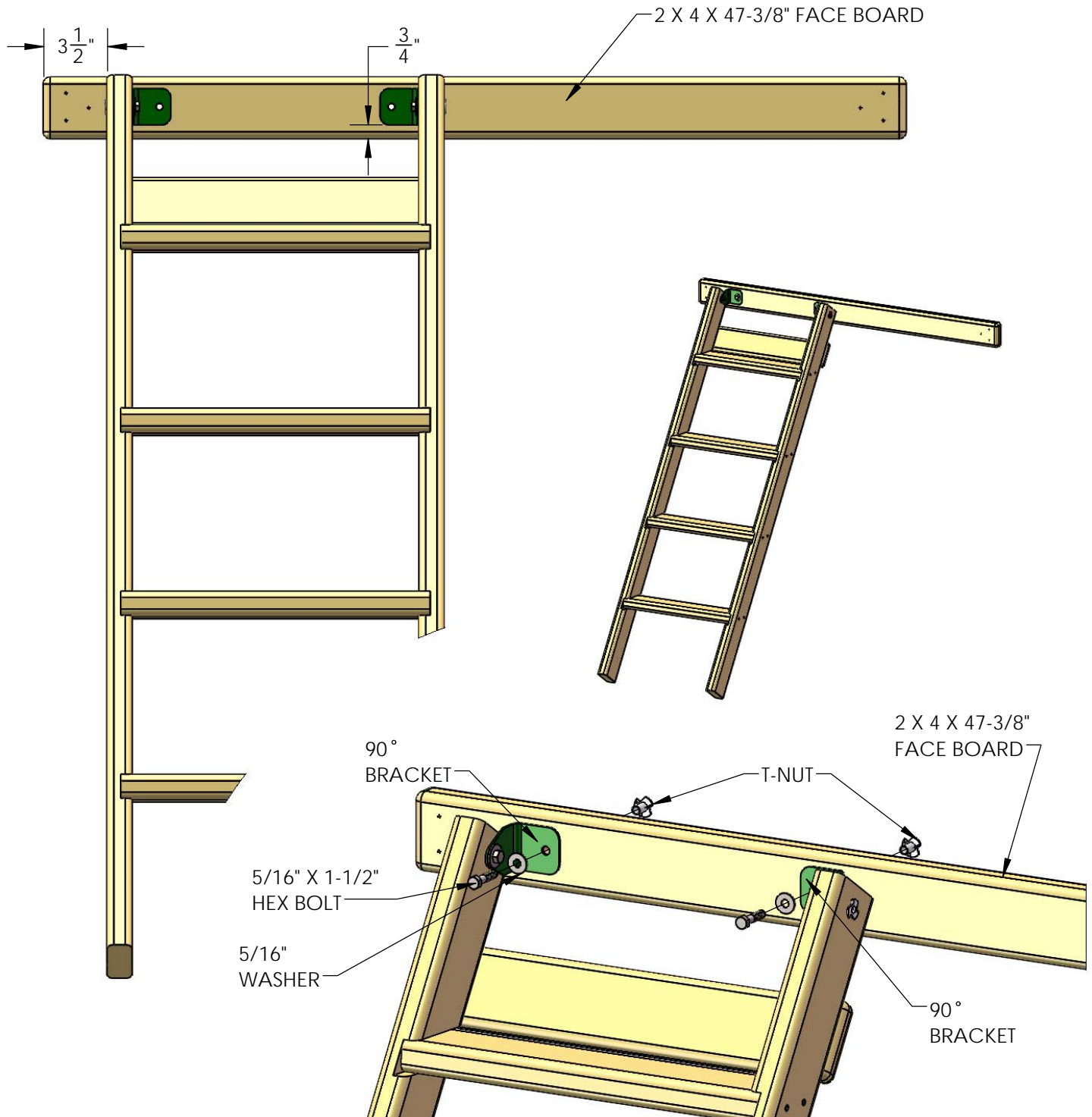

## STEP 25: LADDER TO SET

1: PLACE THE FACE BOARD (WITH LADDER) ONTO THE FRONT OF THE PLAY SET MAKING SURE THE TOP OF THE BOARD IS FLUSH WITH THE TOP OF THE DECK SPACERS.

2: ATTACH THE FACE BOARD TO THE CORNER POSTS WITH SIX #8 X 2-1/2" WOOD SCREWS.

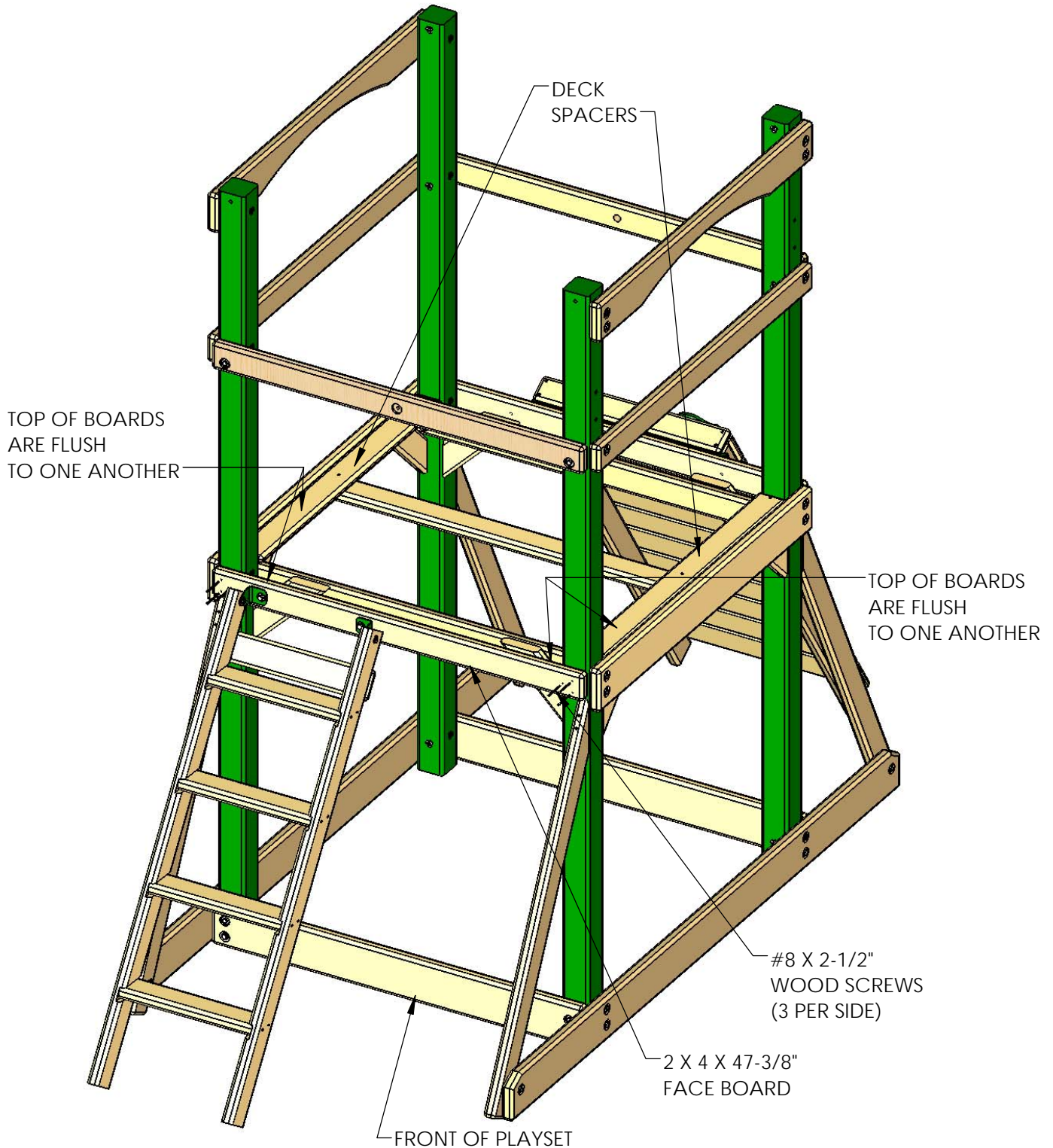



## STEP 26: DECK BOARDS

1: SEVEN 5/4 X 6 X 47-3/8" DECK BOARDS WILL LAY ACROSS THE DECK SUPPORTS, FLUSH TO THE FACE BOARDS. THERE WILL BE APPROXIMATELY A 1/4" GAP BETWEEN EACH DECK BOARD.

2: SPACE THE DEK BOARDS EVENLY ACROSS THE SUPPORTS.

3: SECURE EACH DECK BOARD TO THE DECK SUPPORTS AND THE DECK STRINGER WITH FIVE 2" WOOD SCREWS. TWO PER END AND ONE IN THE CENTER.

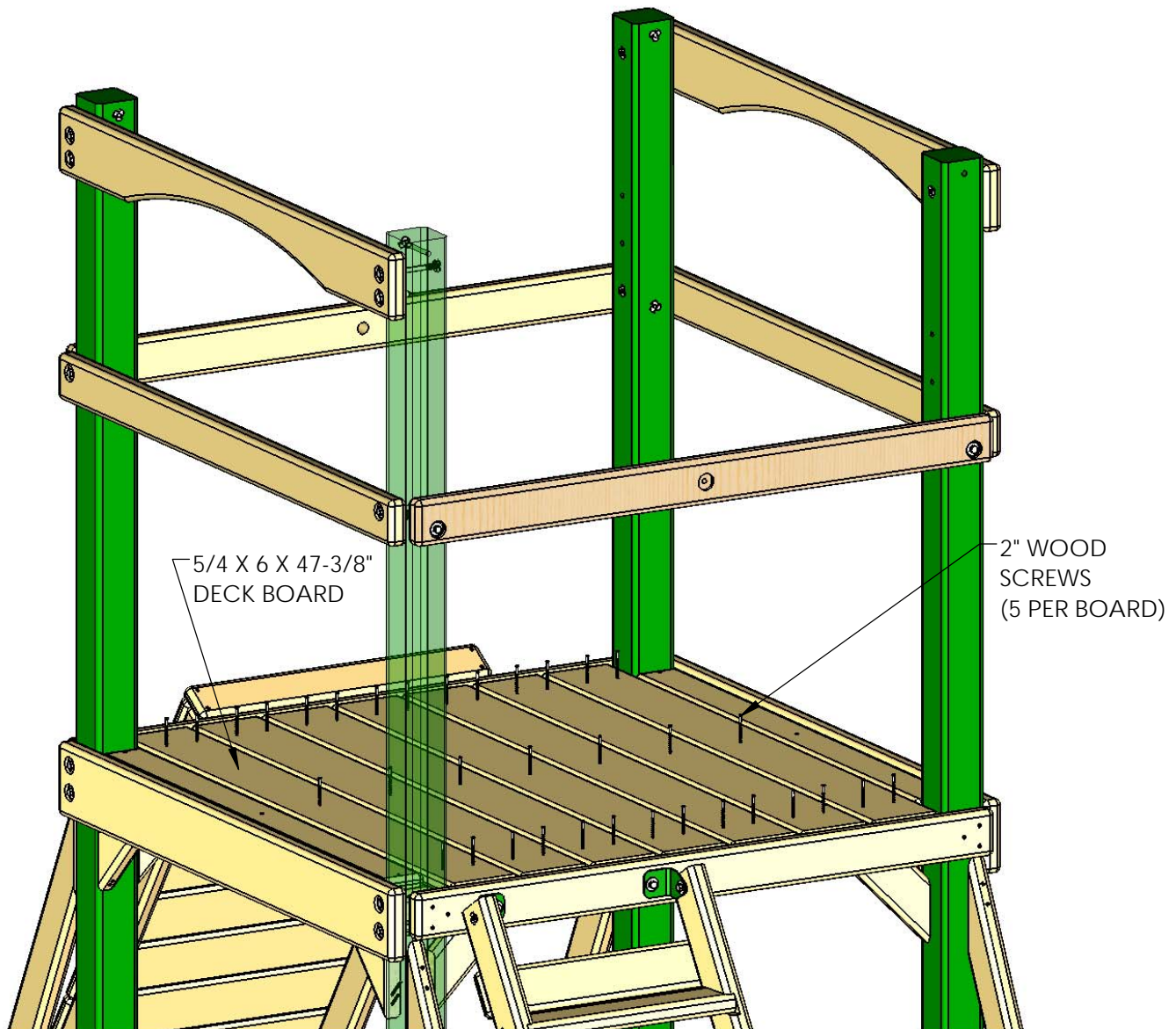

## STEP 27: PANEL BOARDS

1: PLACE THE 2 X 4 X 12" BOTTOM PANEL BOARD - LEFT AND 2 X 4 X 12" BOTTOM PANEL BOARD - RIGHT ON TOP OF THE FACE BOARD AS SHOWN BELOW. THE END OF EACH BOARD SHOULD BE FLUSH TO THE SIDE OF THE CORNER POST. ATTACH EACH BOTTOM PANEL BOARD WITH ONE 5/16" X 3-1/2" LAG SCREW AND ONE 5/16" WASHER.

2: PLACE THE 2 X 4 X 47-3/8" PANEL SUPPORTS ON TOP OF THE BOTTOM PANEL BOARDS AT THE LEFT AND RIGHT SIDES OF THE PLAYSET WITH THE HOLES OFFSET DOWN. ATTACH THE PANEL SUPPORTS USING 5/16" X 3-1/2" LAG SCREWS AND 5/16" WASHERS.

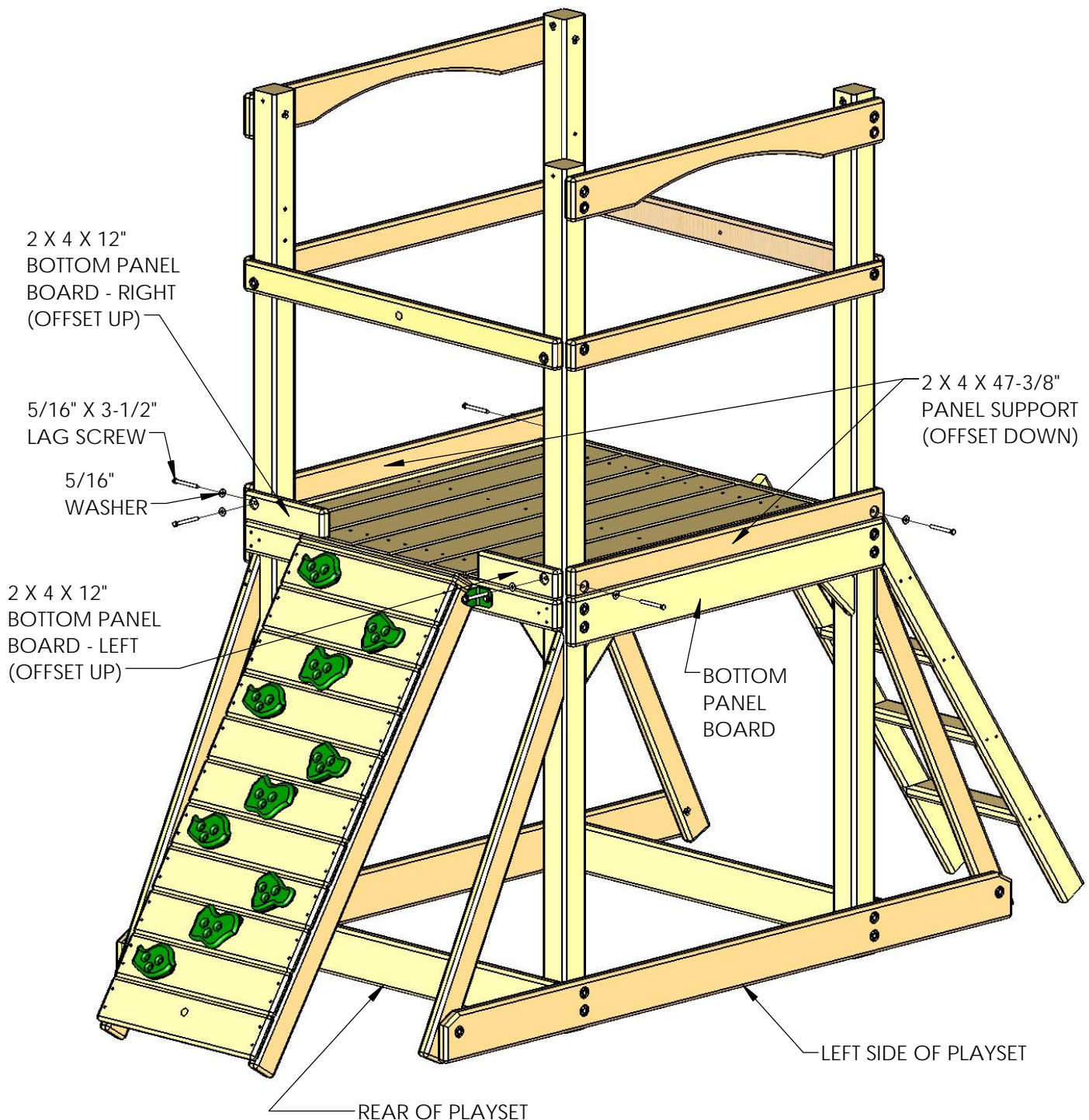

## STEP 28: PANEL SLATS

- 1: FIND SEVENTEEN 5/4 X 2-5/8" X 28-1/4" PANEL SLATS.
- 2: INSTALL THE PANEL SLATS AT EQUAL LENGTHS. SEE DETAIL BELOW FOR MEASUREMENTS
- 3: ATTACH THE PANEL SLATS TO THE FORT WITH 2" WOOD SCREWS IN THE PRE-DRILLED HOLES.

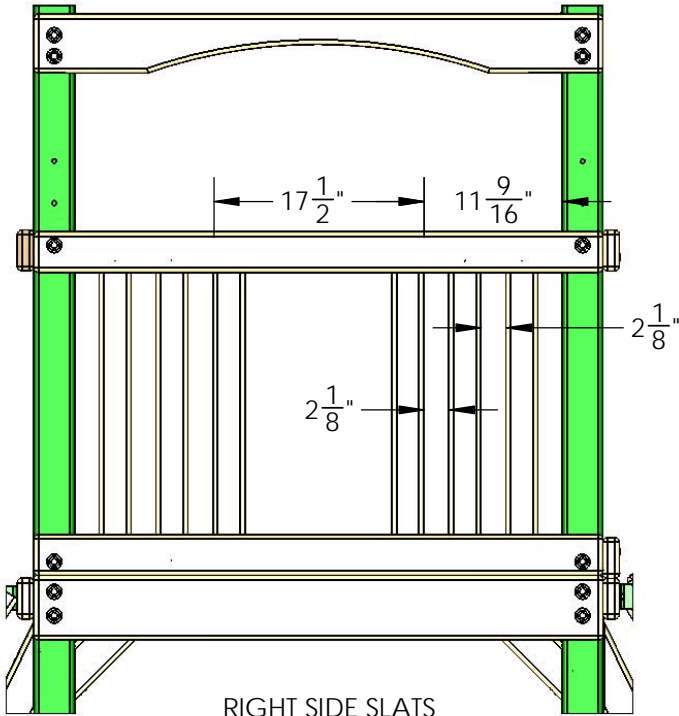

RIGHT SIDE SLATS  
(VIEW FROM OUTSIDE THE PLAY SET)

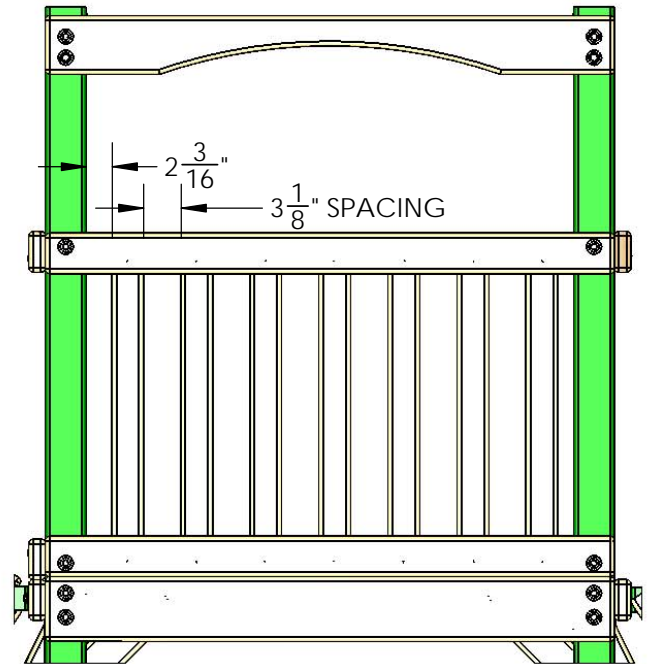

LEFT WALL SLATS  
(VIEW FROM OUTSIDE THE PLAY SET)

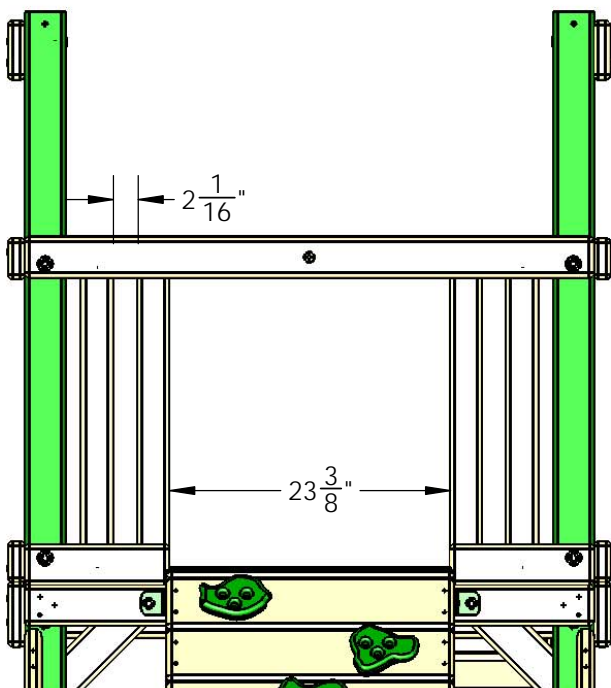

ROCK WALL SLATS  
(VIEW FROM OUTSIDE THE PLAY SET)

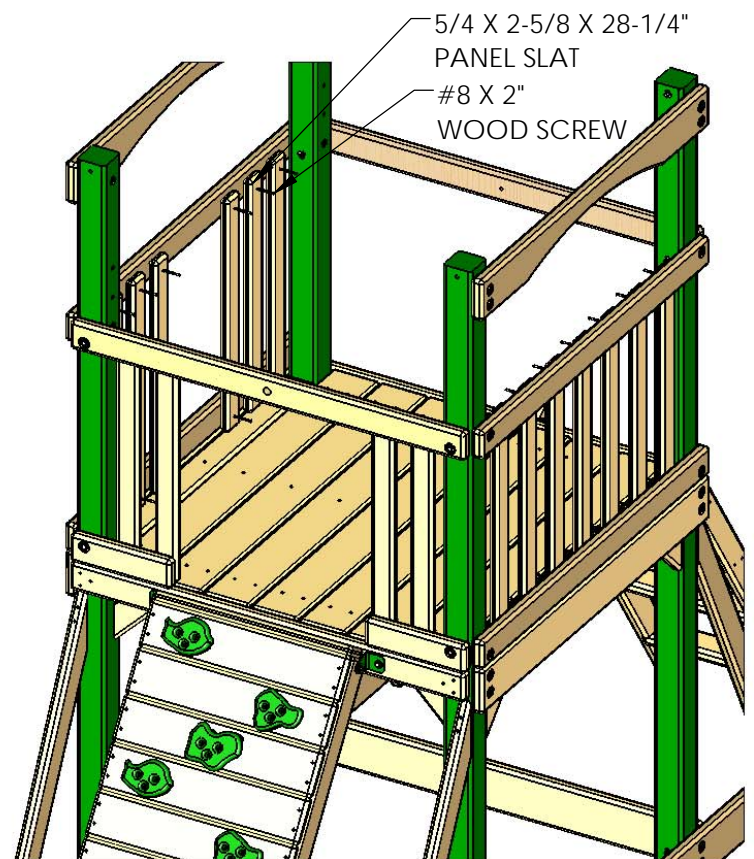

## STEP 29: CENTER POST

IN THIS STEP YOU WILL BE INSTALLING THE CENTER POST. YOU MUST USE THE CENTER POST FROM THE 383 WOOD KIT. THE CENTER POST IN THE 380 WOOD KIT WILL NOT WORK FOR THIS PLAYSET.

1: HAMMER A T-NUT INTO THE HOLE OF THE 2 X 4 X 28-5/8" CENTER POST. THE HOLE SHOULD BE 1-3/8" DOWN FROM THE TOP AS SHOWN BELOW. IF IT IS 1" THEN YOU HAVE THE WRONG CENTER POST.

2: PLACE THE CENTER POST ON THE INSIDE OF THE FRONT PANEL SUPPORT. LINE UP THE HOLES AND SECURE THE CENTER POST TO THE FRONT PANEL SUPPORT WITH A 5/16" X 2-1/2" HEX BOLT AND A 5/16" WASHER.

3: SQUARE THE CENTER POST TO THE DECK AND SECURE THE BOTTOM OF THE CENTER POST TO THE DECK BOARD WITH TWO #8 X 2-1/2" WOOD SCREWS.

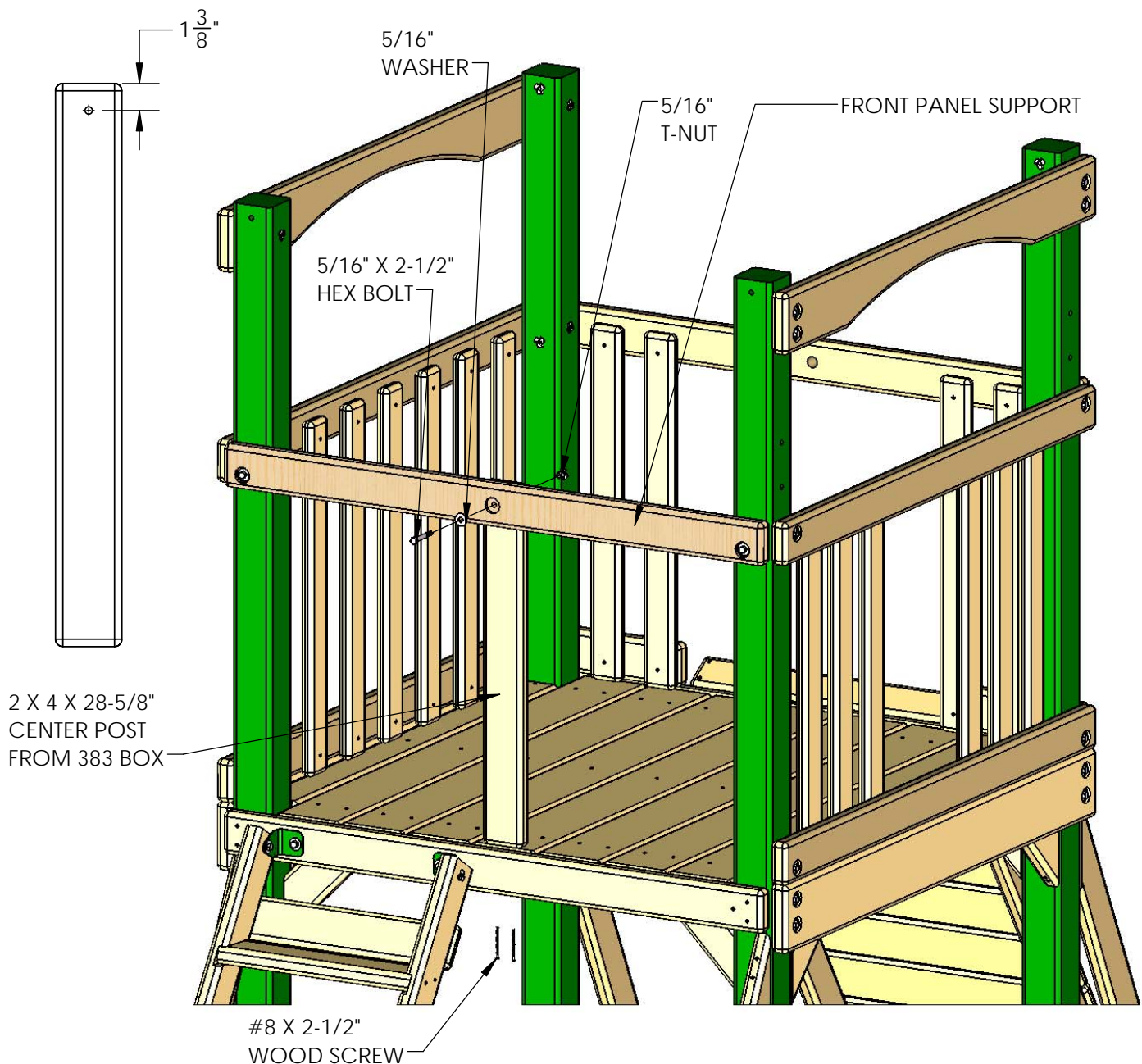

## STEP 30: IRON DUCTILE SWING HANGERS

SHOULD YOUR SWING BEAM HAVE A SLIGHT BOW TO IT THEN PLACE THE BOW SIDE UP. THE SWING HANGERS WILL BE ON THE BOTTOM.

2: LINE UP THE HOLES OF THE IRON DUCTILE SWING HANGERS WITH THE HOLES IN THE SWING BEAM.

3: FASTEN EACH SWING HANGER TO THE SWING BEAM USING 3/8" X 7" CARRIAGE BOLTS WITH TORQUE WASHERS ON TOP. PLACE THE CARRIAGE BOLT THROUGH THE SQUARE HOLE IN THE TORQUE WASHER. PLACE THE END OF THE CARRIAGE BOLT INTO THE HOLE IN THE SWING BEAM. THE TEETH OF THE TORQUE WASHER SHOULD BE IN CONTACT WITH THE BEAM. NOW HIT THE TOP OF THE CARRIAGE BOLT UNTIL THE TEETH GO INTO THE BEAM AND THE BOTTOM OF THE TORQUE WASHER IS FLUSH TO THE TOP OF THE BEAM.

4: PLACE THE SWING HANGER OVER THE END OF THE CARRIAGE BOLTS. SECURE THE SWING HANGER TO THE BEAM WITH 3/8" WASHERS AND 3/8" LOCK NUTS. PLACE BOLT CAPS ON THE END OF THE CARRIAGE BOLTS TO COVER THE EXPOSED THREADS.

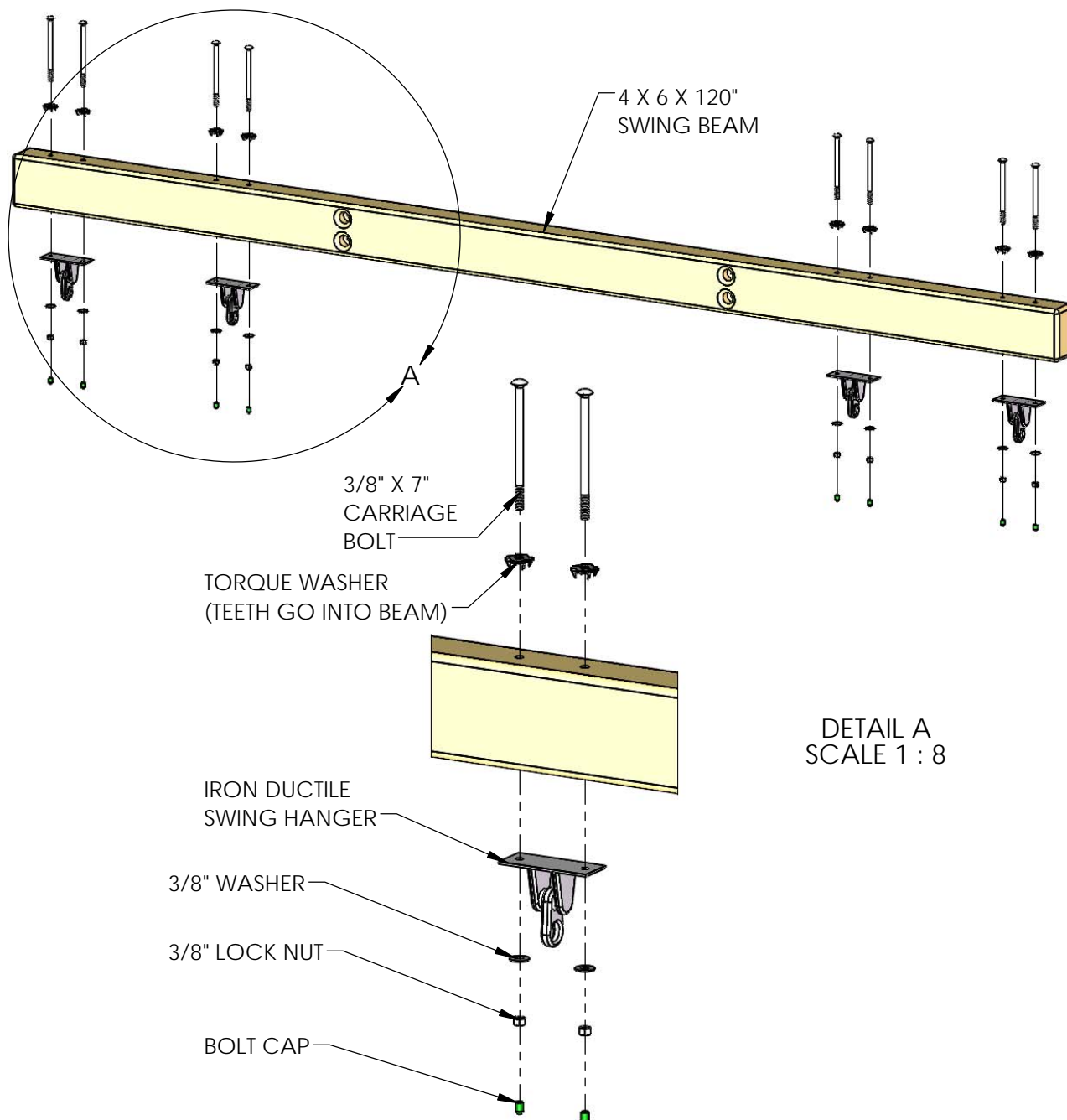

## STEP 31: SWING BEAM TO SET

HAVE AN ASSISTANT HELP YOU PLACE THE SWING BEAM ABOVE THE FRONT PANEL SUPPORT. HOLD THE SWING BEAM IN PLACE.

1: THE HOLES IN THE SWING BEAM SHOULD BE APPROXIMATELY CENTERED ON THE CORNER POSTS. DRILL AN  $1\frac{1}{64}$ " HOLE BY ABOUT 2- $\frac{1}{2}$ " DEEP THROUGH THE BOTTOM HOLES OF THE SWING BEAM INTO THE CORNER POSTS. IT WILL PROBABLY BE NECESSARY TO REMOVE THE BEAM TO DRILL THE  $1\frac{1}{64}$ " HOLES TO THE 2- $\frac{1}{2}$ " DEPTH.

THEN USE A  $\frac{3}{8}$ " DRILL BIT AND BORE THROUGH THE TOP HOLES INTO THE CORNER POSTS. IF NECESSARY, REMOVE THE BEAM TO BORE THE  $\frac{3}{8}$ " HOLES ALL THE WAY THROUGH THE CORNER POSTS.

2: PLACE A TORQUE WASHER OVER THE END OF A  $\frac{3}{8}$ " X 6- $\frac{1}{2}$ " CARRIAGE BOLT. PLACE THE END OF THE CARRIAGE BOLT INTO THE CORNER POST HOLE. THE TEETH OF THE CARRIAGE BOLT SHOULD BE IN CONTACT WITH THE CORNER POST. STRIKE THE END OF THE CARRIAGE BOLT AND DRIVE THE TEETH INTO THE CORNER POST UNTIL THE BOTTOM OF THE TORQUE WASHER IS FLUSH TO THE SURFACE OF THE CORNER POST.

3: NOW REPEAT SUBSTEP 2 FOR THE OTHER HOLE IN THE OTHER CORNER POST.

4: PLACE A  $\frac{3}{8}$ " WASHER AND A  $\frac{3}{8}$ " LOCK NUT ONTO THE END OF EACH CARRIAGE BOLT AND TIGHTEN THEM. THEN PLACE A BOLT CAP ON THE END OF THE EXPOSED CARRIAGE BOLT THREADS.

5: DRIVE A  $\frac{3}{8}$ " X 5" LAG SCREW WITH  $\frac{3}{8}$ " WASHER INTO EACH BOTTOM HOLE IN THE SWING BEAM.

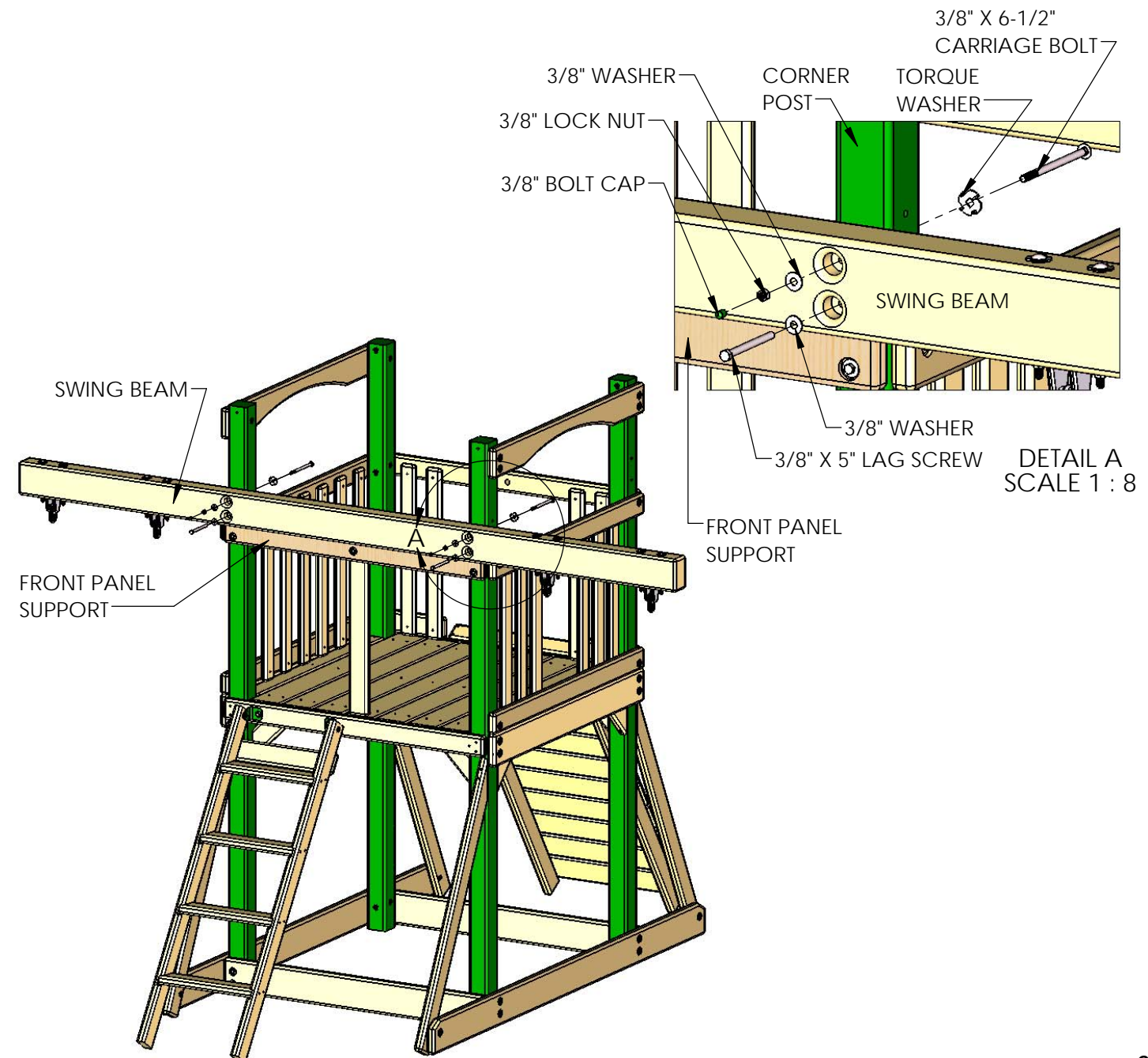

## STEP 32: ROOF SUPPORT ASSEMBLIES

1: LOCATE TWO 2 X 4 X 35.50" ROOF SUPPORT (LEFT), TWO 2 X 4 X 35.50" ROOF SUPPORT (RIGHT) AND TWO 5/4 X 6 X 10.50" ROOF PEAK SUPPORT PIECES.

2: FIND A FLAT SURFACE TO WORK ON. LAY THE ROOF SUPPORTS DOWN ON THE FLAT SURFACE WITH THE COUNTER-SUNK HOLES FACING DOWN. ALIGN THE ANGLED ENDS OF THE ROOF SUPPORTS FLUSH WITH ONE ANOTHER. PLACE A ROOF PEAK SUPPORT ON TOP OF THE ROOF SUPPORTS AS SHOWN. THE EDGES SHOULD BE FLUSH WHERE SHOWN BELOW.

3: USE FOUR #8 X 2" WOOD SCREWS TO ATTACH THE ROOF PEAK SUPPORT TO THE ROOF SUPPORTS AS SHOWN BELOW.

4: MAKE ONE MORE ROOF SUPPORT ASSEMBLY BY REPEATING SUB-STEPS 2 AND 3.

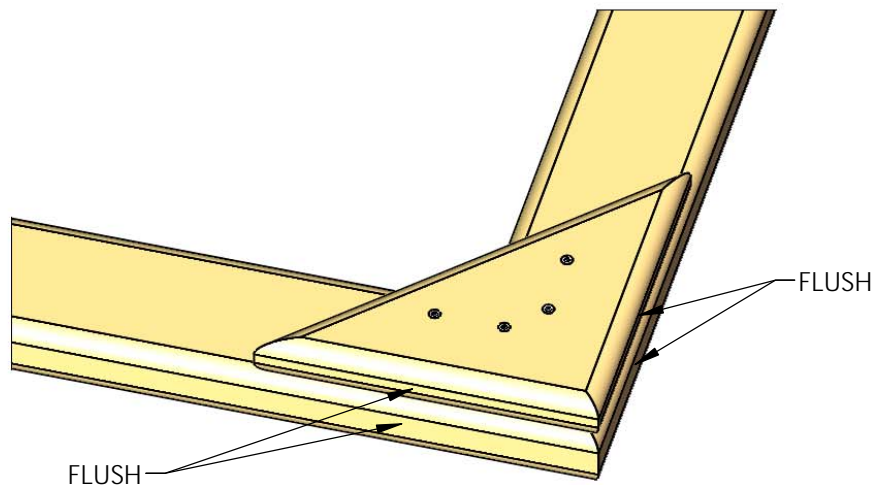
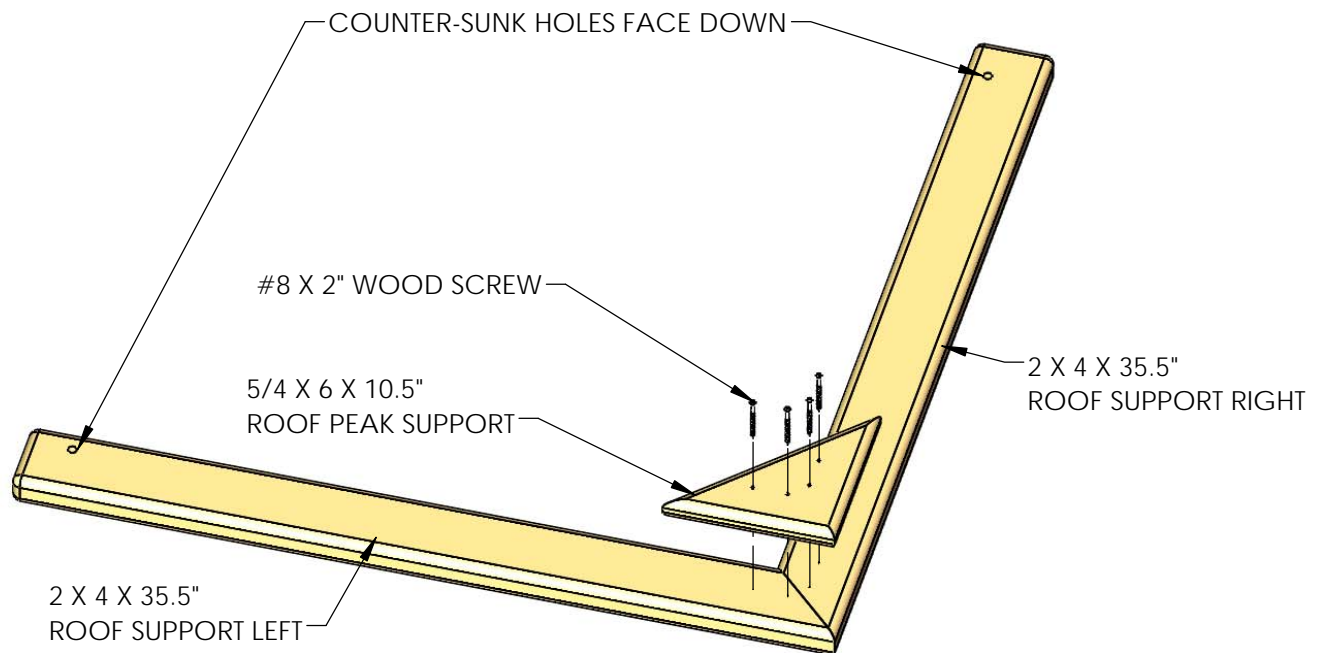

## STEP 33: ROOF SUPPORT ASSEMBLIES

1: ATTACH THE ROOF SUPPORT ASSEMBLIES TO THE CORNER POSTS WITH 5/16" X 4-1/2" HEX BOLTS AND 5/16" WASHERS.

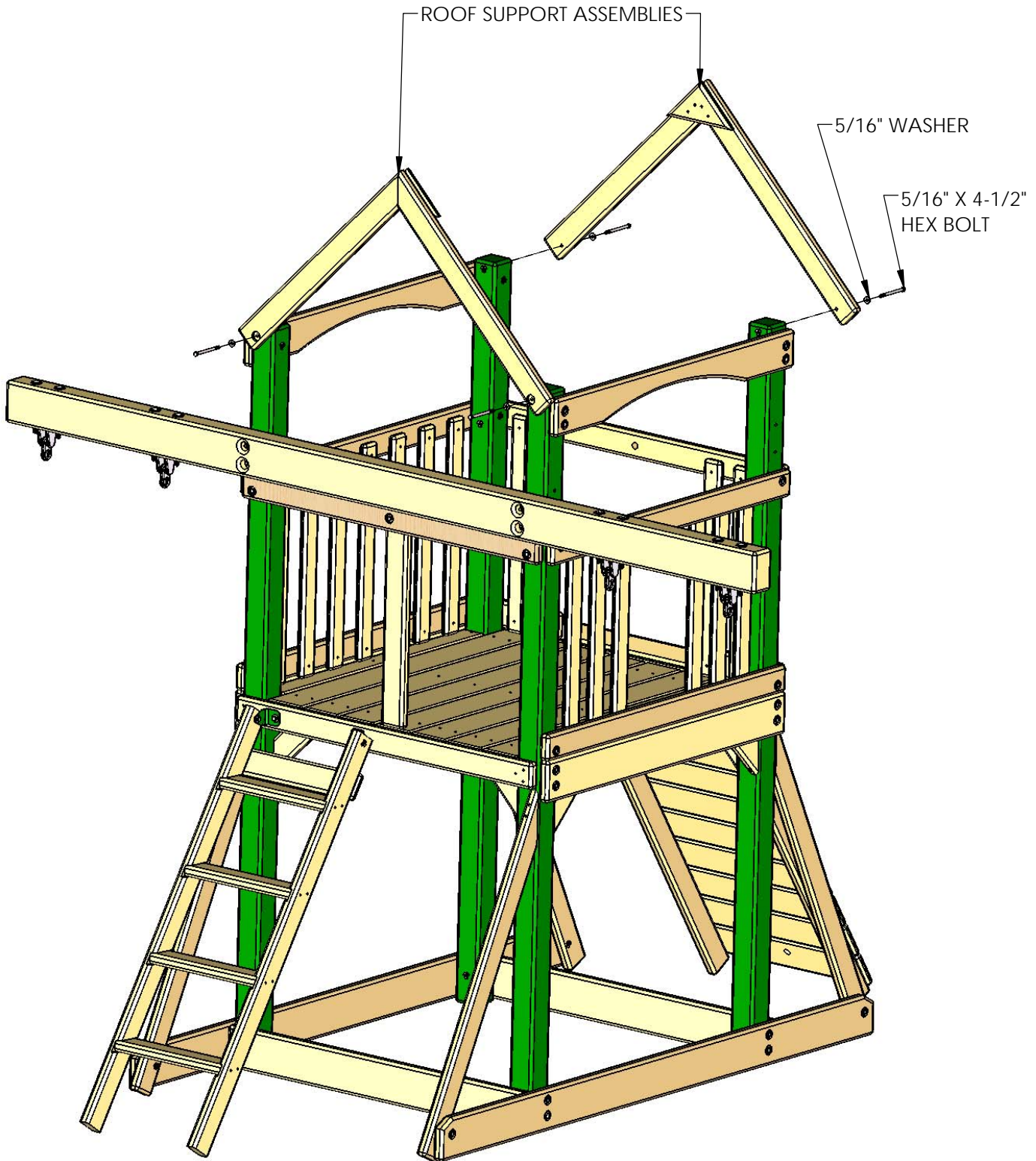



## STEP 34: ROOF STARTERS / ROOF PEAK

1: PLACE THE 1 X 5 X 52" (GROOVE ONLY) ROOF STARTER BOARDS AT THE PEAK OF THE ROOF. THE HOLES IN THE ROOF STARTERS SHOULD BE CENTERED ON THE ROOF SUPPORTS. THE FLAT SIDE OF THE ROOF STARTERS SHOULD BE PLACED AS CLOSE TOGETHER AS POSSIBLE NEAR THE PEAK WITHOUT THE BOARDS OVERLAPPING.

2: FASTEN THE ROOF STARTER BOARDS TO THE ROOF SUPPORTS WITH 1-1/2" WOOD SCREWS.

3: PLACE THE 3-1/2 X 3-1/2 X 52" ROOF PEAK ON TOP OF THE ROOF STARTER BOARDS AND FASTEN WITH FOUR 1-1/2" WOOD SCREWS.

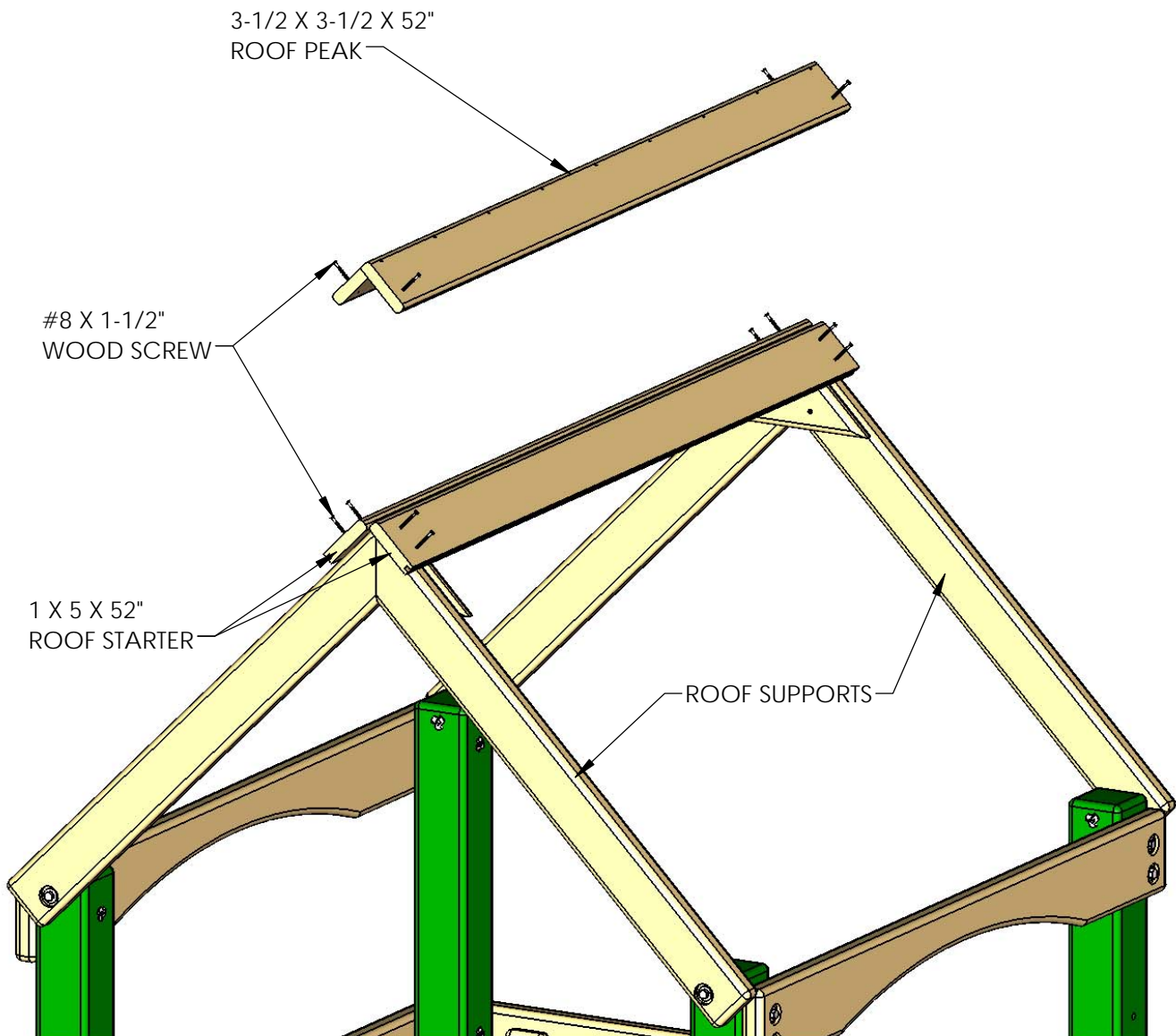

## STEP 35: ROOF BOARDS / ROOF FINISHERS AND CHIMNEY AND DORMERS

1: PLACE THE 1 X 5 X 52" ROOF BOARDS ON TOP OF THE ROOF SUPPORTS, FITTING THE TONGUE INTO THE GROOVE OF THE ROOF STARTER. THE HOLES IN THE ROOF BOARDS SHOULD BE CENTERED OVER THE ROOF SUPPORTS. THERE ARE SEVEN ROOF BOARDS ON EACH SIDE OF THE ROOF. IF NECESSARY PLACE A SCRAP 2 X 4 BOARD AGAINST THE ROOF BOARD AND HAMMER ON IT TO SEAT THE TONGUE INTO GROOVE FOR THE ROOF BOARDS. FASTEN EACH ROOF BOARD TO THE ROOF SUPPORTS WITH FOUR 1-1/2" WOOD SCREWS.

2: PLACE THE 1 X 5 X 52" ROOF FINISHER AT THE END OF THE ROOF ASSEMBLY AND FASTEN TO THE ROOF SUPPORTS WITH FOUR 1-1/2" WOOD SCREWS. EACH SIDE OF THE ROOF GETS ONE ROOF FINISHER.

TIP: USE THE INSTRUCTIONS PROVIDED IN THE APPENDIX TO BUILD THE CHIMNEY AND DORMERS. AFTER PUTTING IN THREE ROOF BOARDS ON THE FRONT ROOF STOP AND THEN INSTALL THE CHIMNEY. NOTICE THE MOUNTING BLOCK FOR THE CHIMNEY WILL GET INSTALLED ON THE FIRST ROOF BOARD. ONCE ALL THE ROOF BOARDS / FINISHERS ARE INSTALLED MOUNT THE DORMERS AS SHOWN BELOW CENTERED ON THE ROOF.

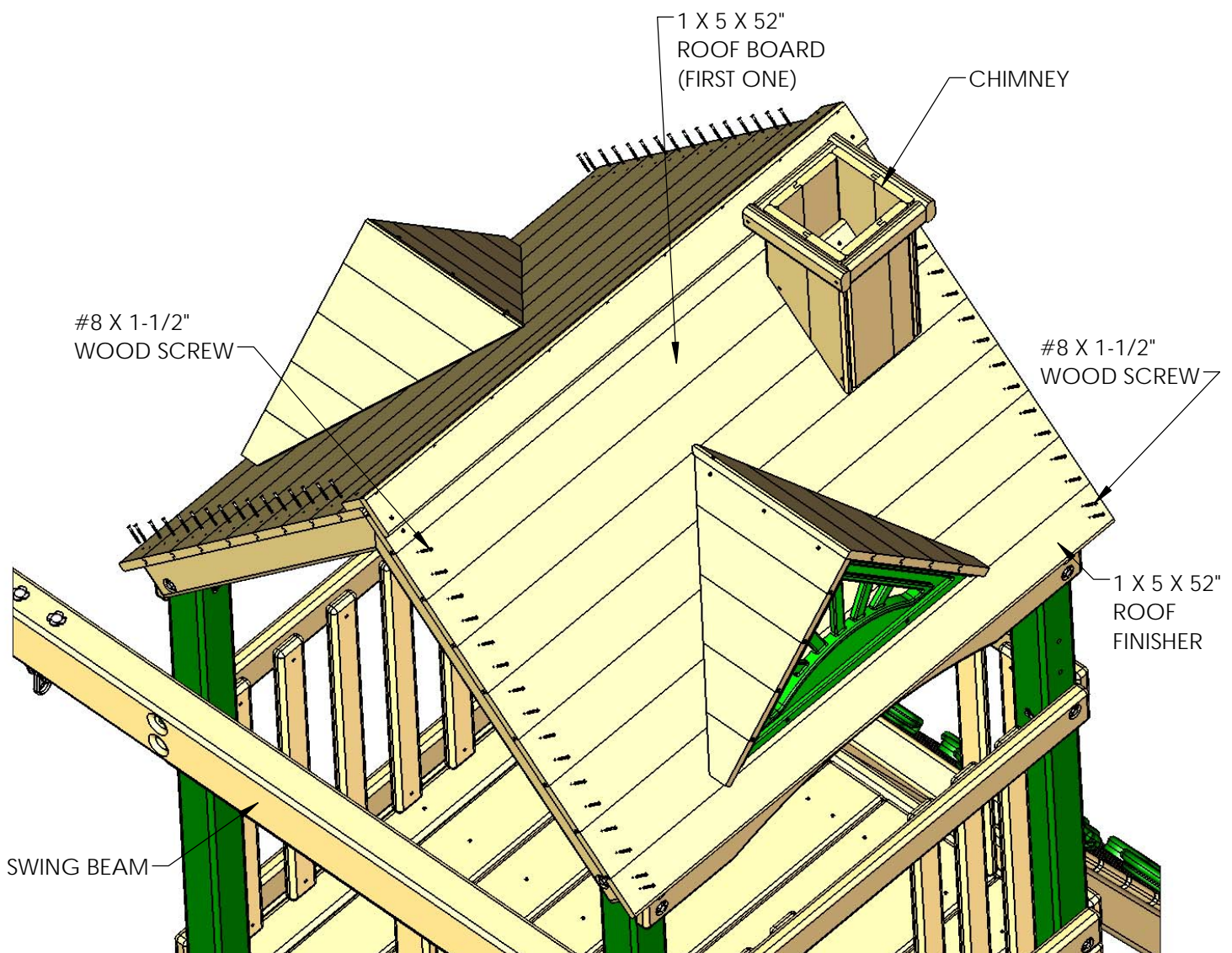

## STEP 36: SUNBURST FILLER BOARD

1: PLACE THE 2 X 4 X 34" SUNBURST FILLER BOARD IN BETWEEN THE ROOF SUPPORTS. FASTEN USING #8 X 2-1/2" WOOD SCREWS THROUGH THE PRE-DRILLED HOLES ON EACH END, MAKE SURE THERE ARE NO GAPS IN BETWEEN THE SUNBURST FILLER BOARD AND THE ROOF SUPPORTS.

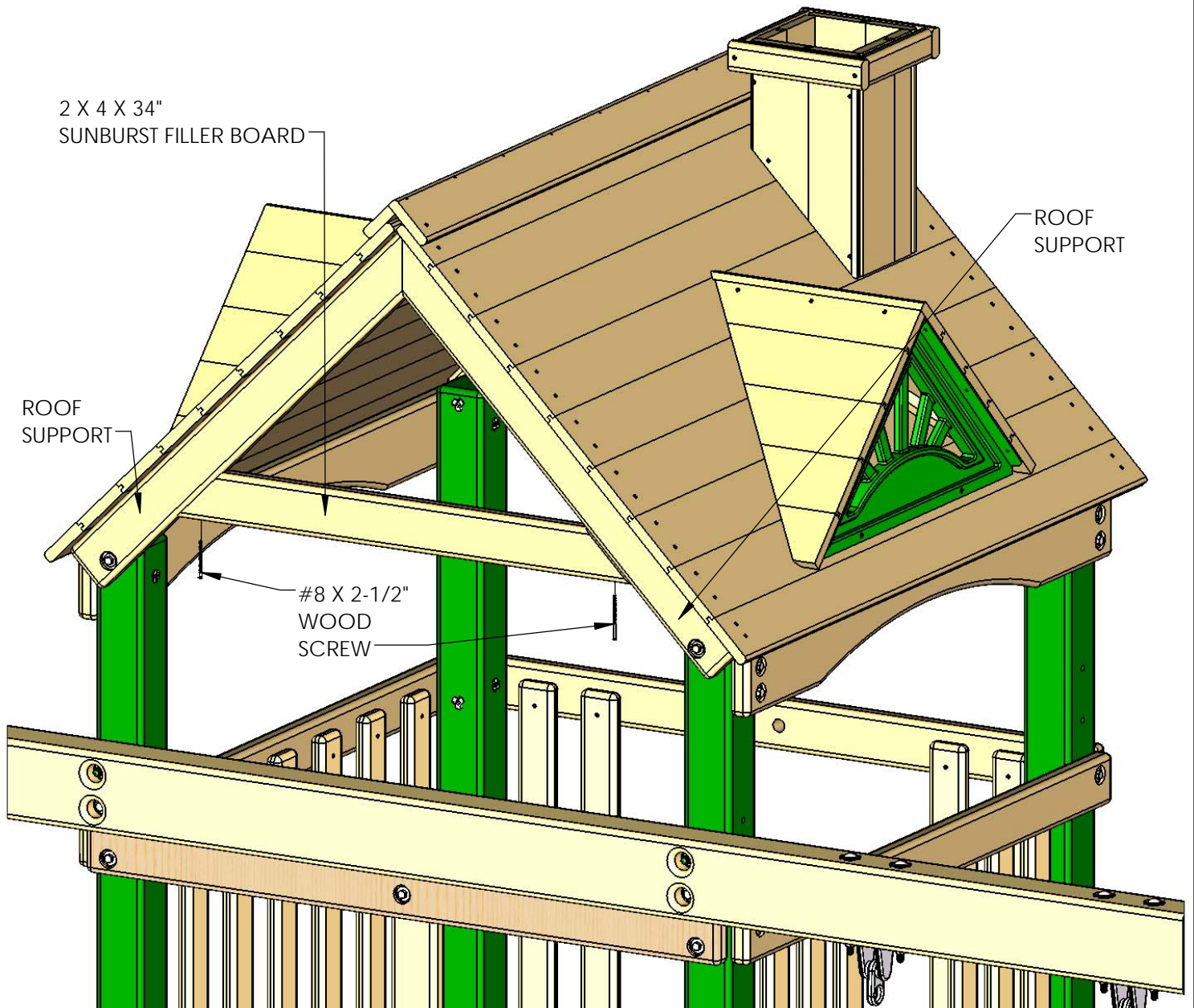

## STEP 37: PLASTIC SUNBURST

- 1: LOCATE TWO PLASTIC SUNBURST PIECES.
- 2: PLACE THE SUNBURST UNDER THE ROOF OVERHANG. FIT IT AGAINST THE BOTTOM SIDE OF THE ROOF BOARDS AND AGAINST THE ROOF SUPPORTS.
- 3: ATTACH THE PLASTIC SUNBURST WITH SIX #8 X 2" WOOD SCREWS ALONG THE SIDES. ATTACH THE TRIANGLE PORTION OF THE SUNBURST PIECE WITH TWO #8 X 2-1/2" WOOD SCREWS.
- 4: REPEAT SUBSTEPS 2 AND 3 ON THE OTHER SIDE OF THE PLAY SET.

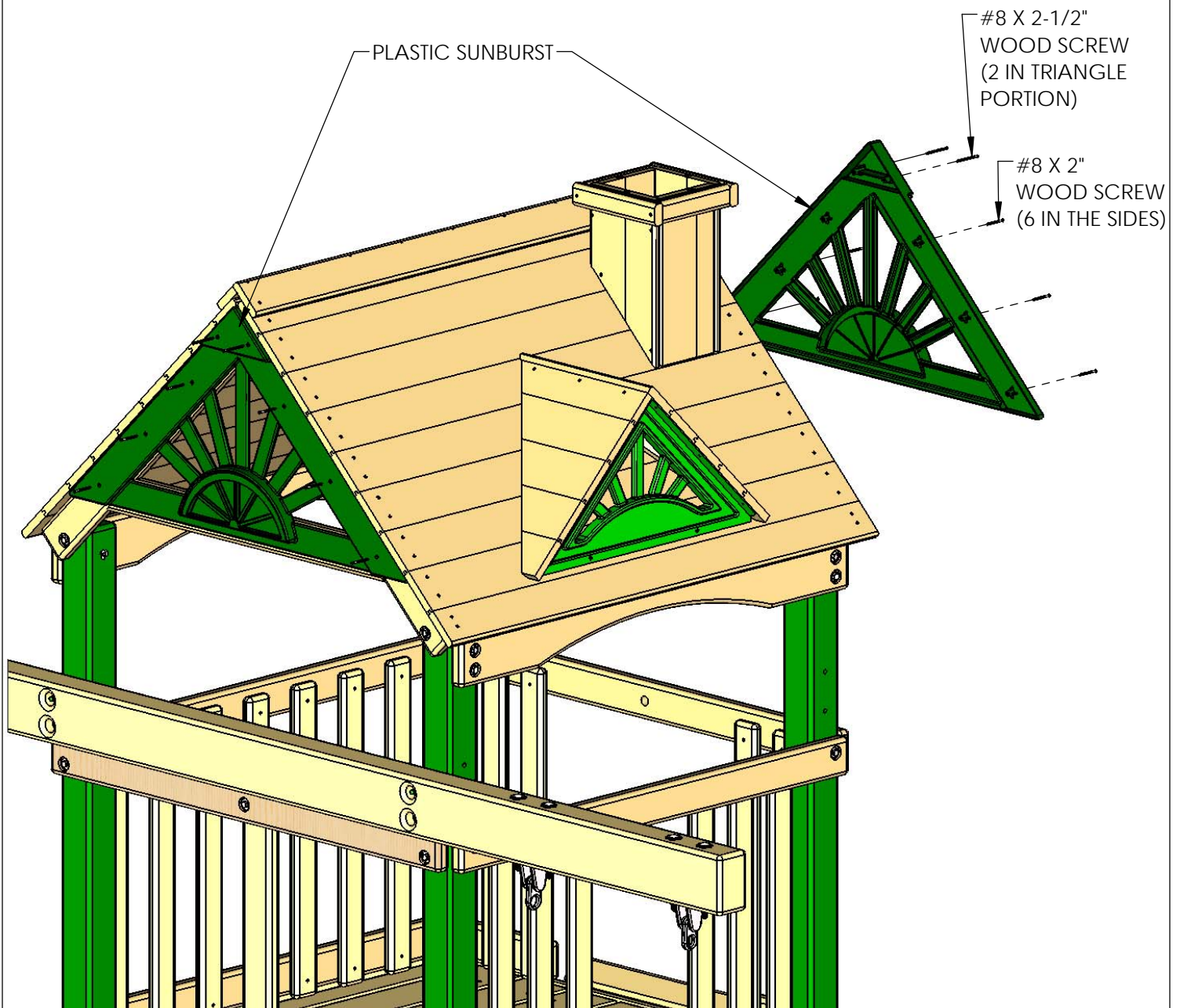

## STEP 38: WINDOW SUPPORTS/WINDOWS

IN THIS STEP THE WOOD COMPONENTS TO ATTACH WINDOWS WILL BE INSTALLED ON THE INSIDE OF THE FRONT OF THE PLAY SET.

- 1: ATTACH THE 5/4 X 6 X 20" VERTICAL WINDOW SUPPORT IN THE CENTER WITH #8 X 2" WOOD SCREWS.
- 2: ATTACH THE 5/4 X 6 X 20" VERTICAL WINDOW SUPPORTS ON THE SIDES WITH #8 X 2" WOOD SCREWS.
- 3: ATTACH THE 5/4 X 2-1/4 X 11-1/2" HORIZONTAL WINDOW SUPPORTS AT THE BOTTOM AND TOP WITH # 8 X 2" WOOD SCREWS.
- 4: GO TO THE OUTSIDE OF THE PLAY SET AND INSTALL THE WINDOWS WITH 1-1/4" WOOD SCREWS.

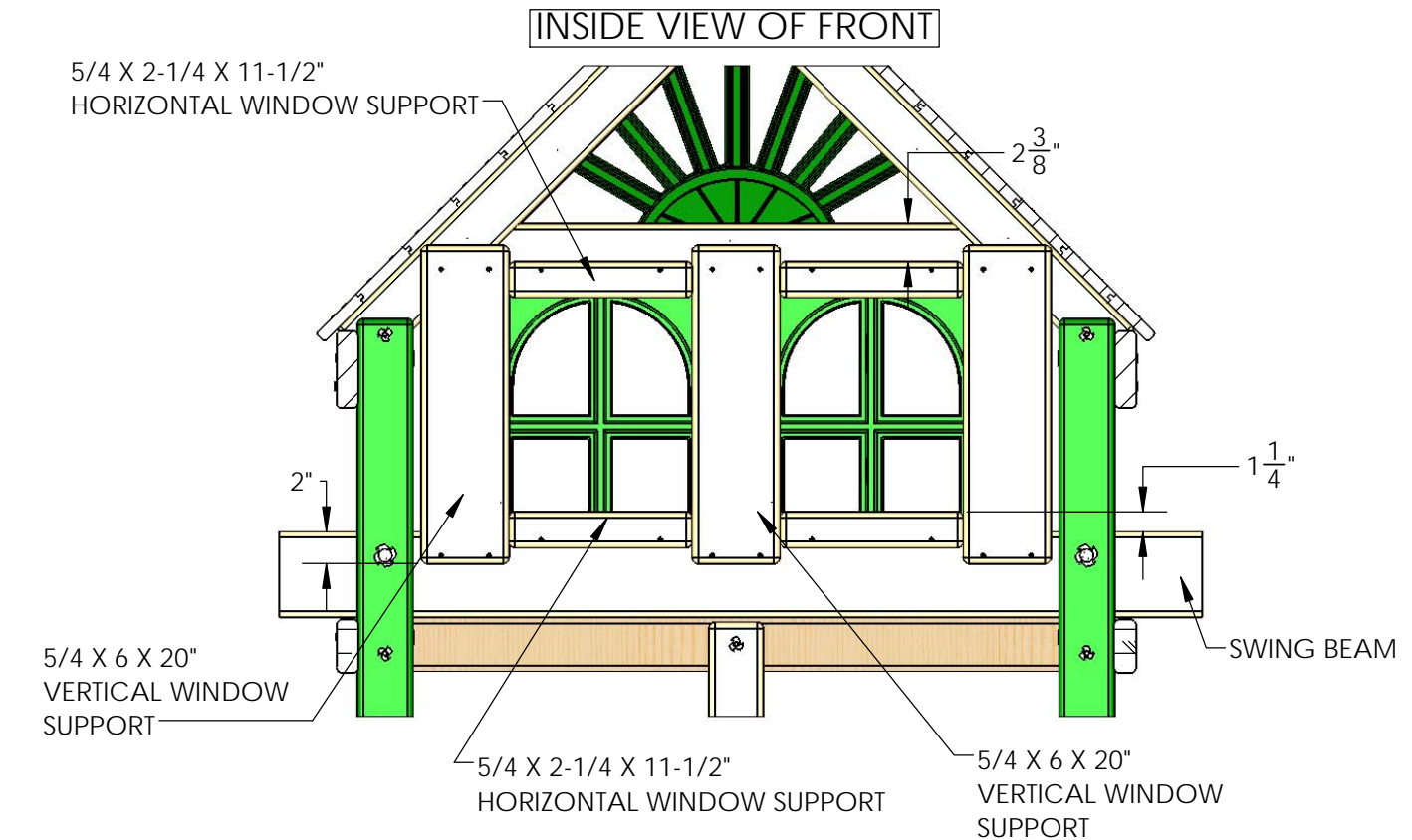

5" INSIDE OF  
CORNER POST TO  
SIDE OF WINDOW.  
ADJUST AS REQUIRED.

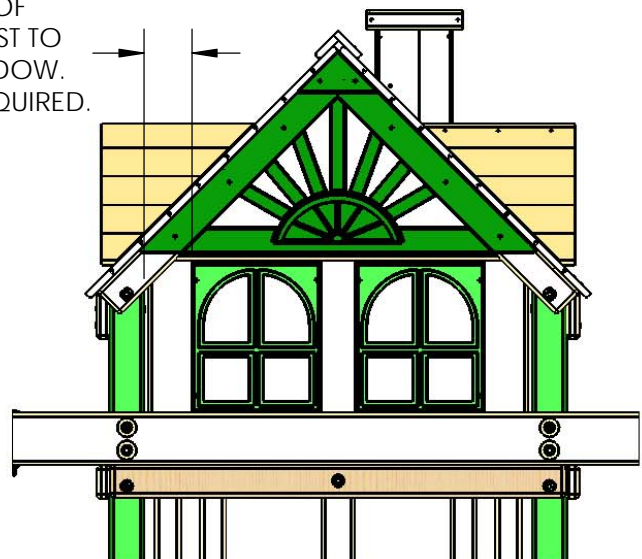

**OUTSIDE VIEW OF FRONT**

## STEP 39: SAFETY BOARDS

THESE BOARDS ARE MEANT TO BE A VISUAL DETERRENT TO PREVENT CHILDREN FROM RUNNING THROUGH THE BASE OF THE PLAY SET INTO OTHER CHILDREN ON THE SWING SET.

- 1: MEASURE 17-1/4" FROM THE TOP OF THE RIGHT OUTRIGGER AND MAKE A MARK ON THE RIGHT CORNER POSTS.
- 2: PLACE THE BOTTOM OF A 2 X 4 X 47-3/8" PANEL SUPPORT WITH OFFSET HOLES DOWN ON THE MARKS.
- 3: ATTACH THE PANEL SUPPORT TO THE RIGHT CORNER POSTS WITH TWO 5/16" X 3-1/2" LAG SCREWS AND TWO 5/16" WASHERS.
- 4: REPEAT SUBSTEPS 1-3 TO INSTALL THE OTHER PANEL SUPPORT ON THE OTHER SIDE OF THE PLAYSET.

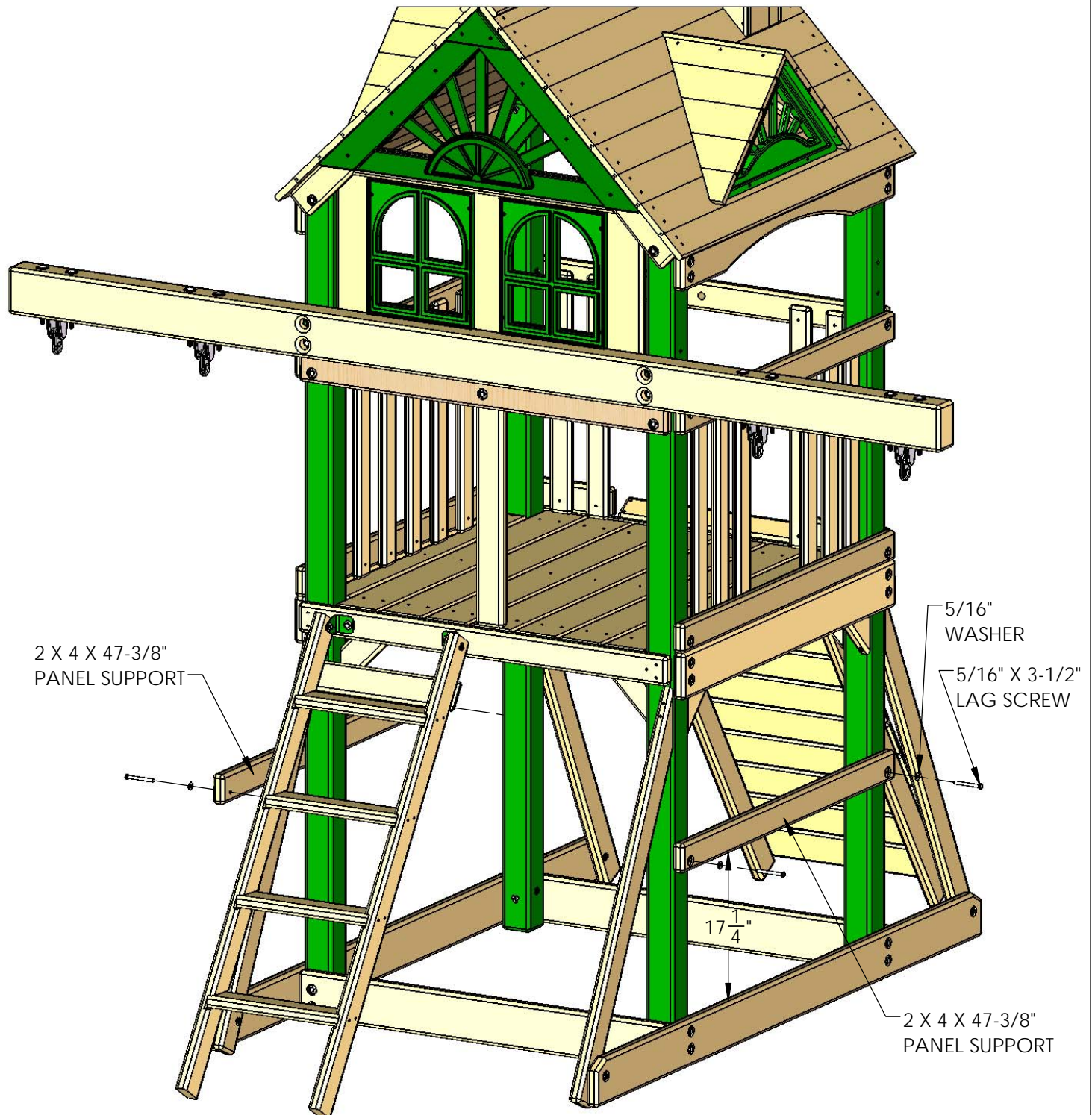

## STEP 40: SLIDE

1: PLACE THE SLIDE IN THE OPENING AT THE FRONT-RIGHT OF THE FORT. LAY THE SLIDE ON THE DECK WITH THE LIP EXTENDING ONTO THE DECK.

2: PRE-DRILL 1/8" HOLES INTO THE DECK BOARDS AT THE SCREW LOCATIONS.

3: ATTACH THE SLIDE TO THE DECK BOARDS WITH 1-1/4" TRUSS HEAD SCREWS. **\*\*DO NOT OVERTIGHTEN\*\***

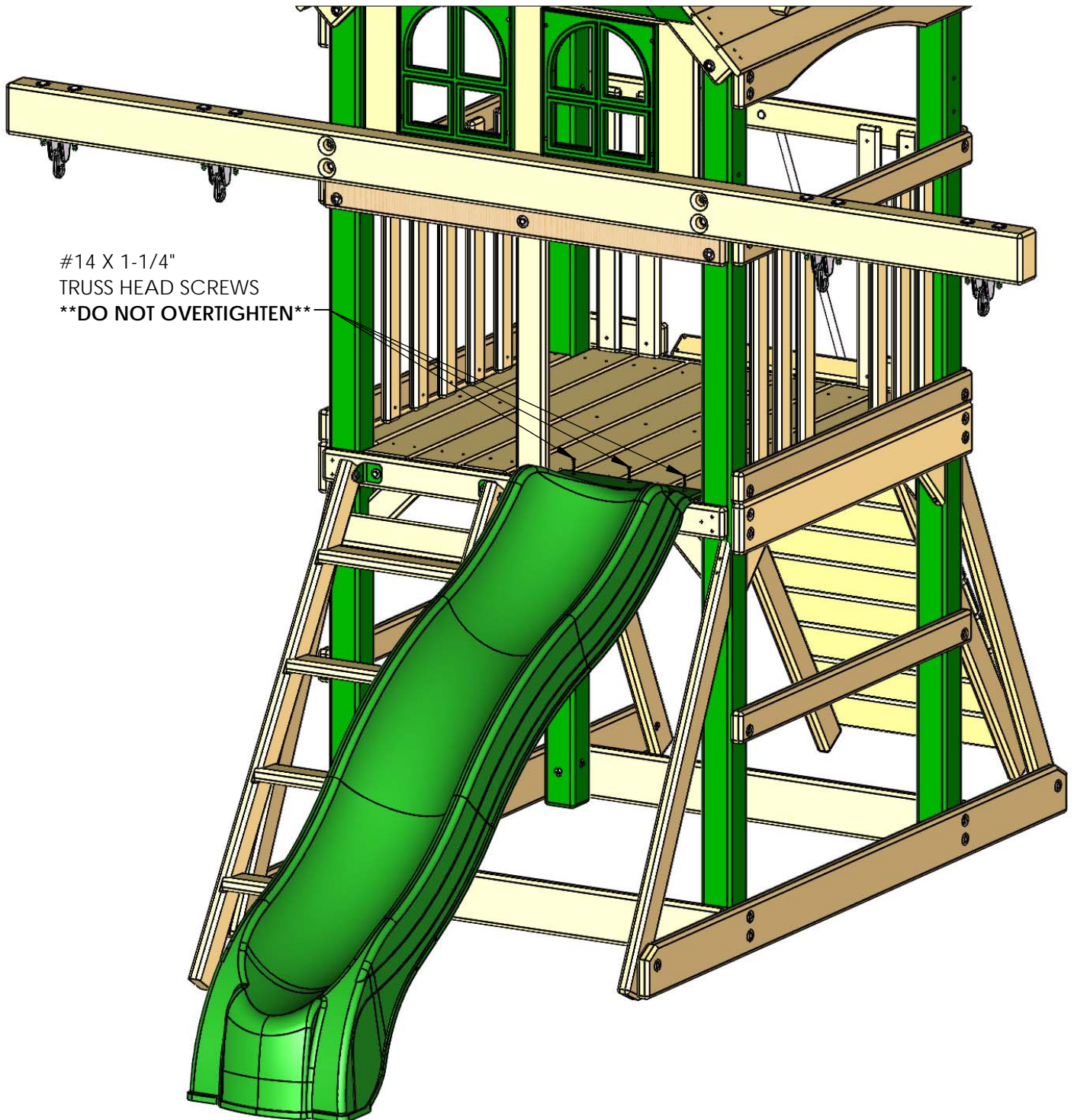

## STEP 41: HANGING THE SWINGS

1: CLIP EACH OF THE SPRING CLIPS ONTO THE IRON DUCTILE SWING HANGERS, THEN CLIP ONTO THE SWING CHAINS.

2: USE THE CLIPS TO ADJUST THE HEIGHT OF THE SWING BY CLIPPING ONTO HIGHER OR LOWER LINKS.

3: COUNT BACK THE SAME NUMBER OF LINKS ON THE OPPOSITE SIDE TO ENSURE THAT SWING IS LEVEL, AND ADJUST TO FIT YOUR NEEDS.

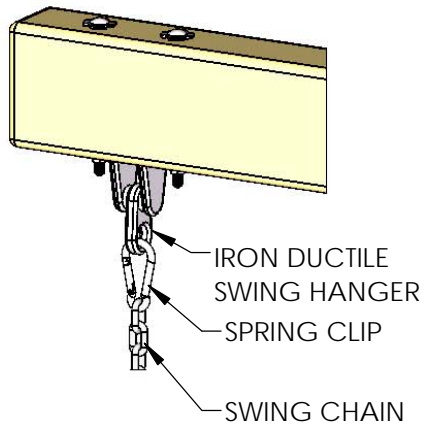

DETAIL A  
SCALE 1 : 8

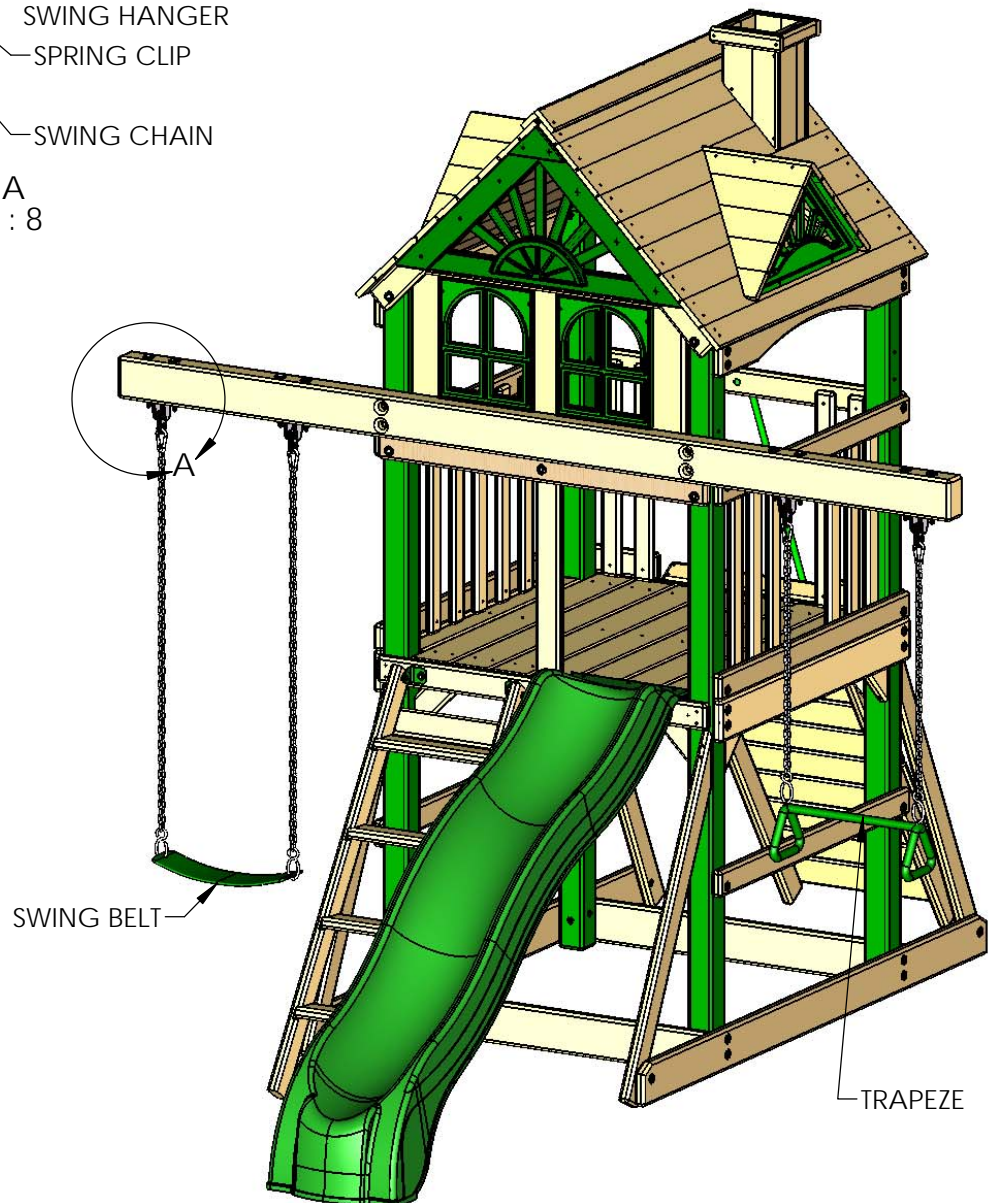



## STEP 42: CLIMBING ROPE

- 1: THREAD ONE END OF THE ROPE THROUGH THE HOLE IN THE ROCK WALL SIDE TOP PANEL BOARD.
- 2: TIE A SECURE KNOT ON THE INSIDE OF THE ROCK WALL SIDE TOP PANEL BOARD.
- 3: THREAD THE OTHER END OF THE ROPE THROUGH THE HOLE IN THE BOTTOM ROCK WALL BOARD. PULL THE ROPE TIGHT AND TIE A SECURE KNOT BEHIND THE BOTTOM ROCK WALL BOARD.
- 4: NOTE: YOU MAY TIE TWO KNOTS IN THE ROPE TO AID IN CLIMBING IF YOU WISH. DO THIS BEFORE PERFORMING SUB STEP 3.
- 5: ONCE THE ROPE IS TIED ON BOTH ENDS ATTEMPT TO WRAP THE ROPE AROUND YOUR HANDS. IF THE ROPE WRAPS AROUND YOUR HAND IT IS TOO LOOSE. UNTIE ONE END AND RETIE THE ROPE UNTIL YOU CAN NO LONGER WRAP IT AROUND YOUR HAND.

TIE A KNOT BEHIND  
THIS HOLE IN THE  
ROCK WALL SIDE  
TOP PANEL BOARD

YOU MAY TIE  
TWO KNOTS IN  
THE ROPE TO  
AID IN  
CLIMBING IF  
YOU WISH.

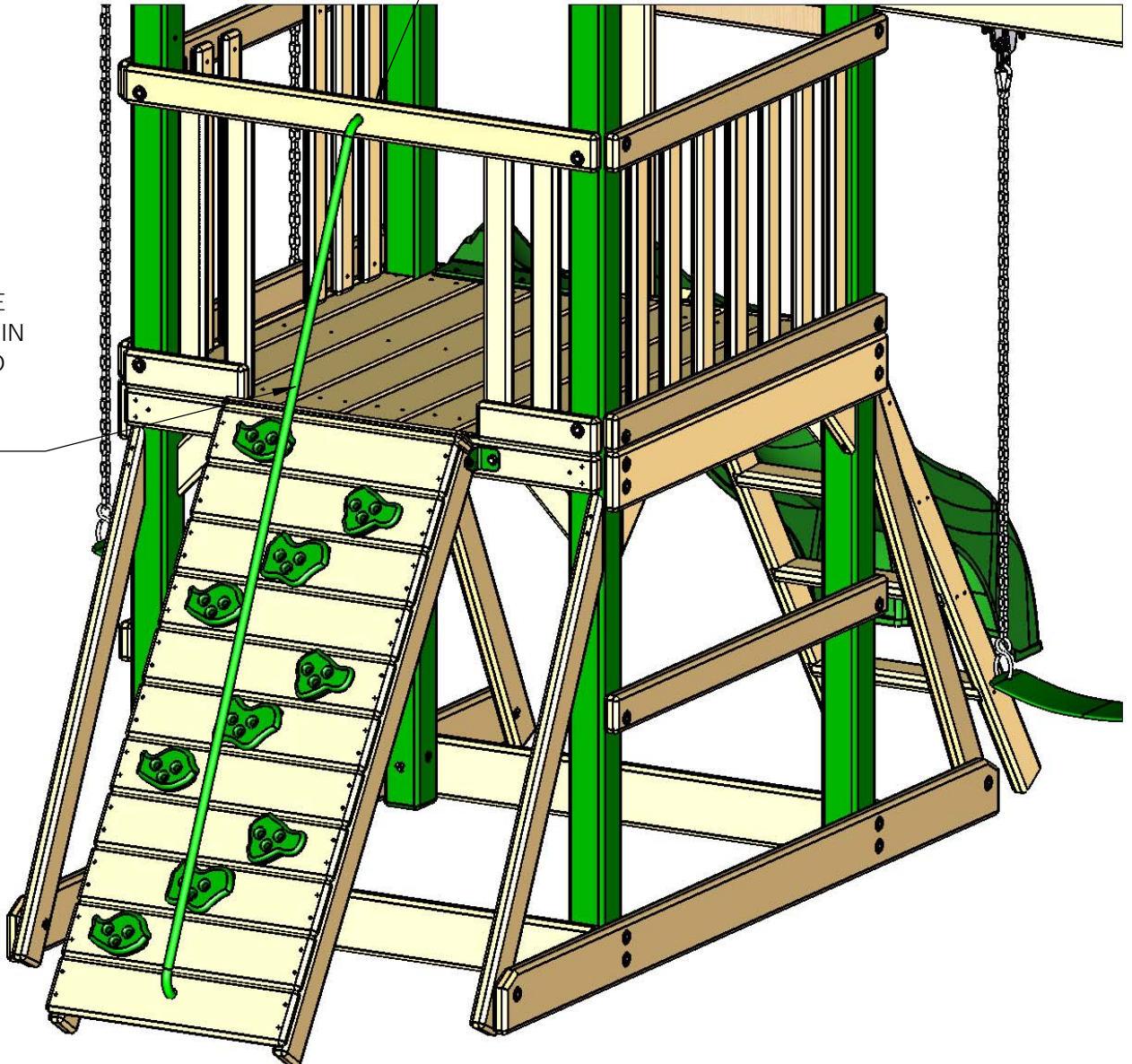

## STEP 43: TELESCOPE

- 1: PLACE ONE OF THE L-SHAPE TELESCOPE MOUNTING BRACKETS CENTERED ON THE PANEL SUPPORT.
- 2: ATTACH THE L-SHAPED BRACKET WITH TWO SCREWS PROVIDED WITH THE TELESCOPE.
- 3: PLACE THE BASE OF THE TELESCOPE INTO THE CUT OUT AREA OF THE L-SHAPED BRACKET.
- 4: ATTACH ANOTHER L-SHAPED TELESCOPE MOUNTING BRACKET DIRECTLY ACROSS FROM THE PREVIOUSLY INSTALLED BRACKET AND SECURE WITH THE PROVIDED HARDWARE.

NOTE: THE REMAINING TWO BRACKETS THAT ARE "C" SHAPED ARE FOR MOUNTING THE TELESCOPE ON TOP OF A 4 X 4 PIECE OF WOOD. THEY MAY BE RECYCLED OR YOU MAY RETAIN THEM IF YOU WISH.

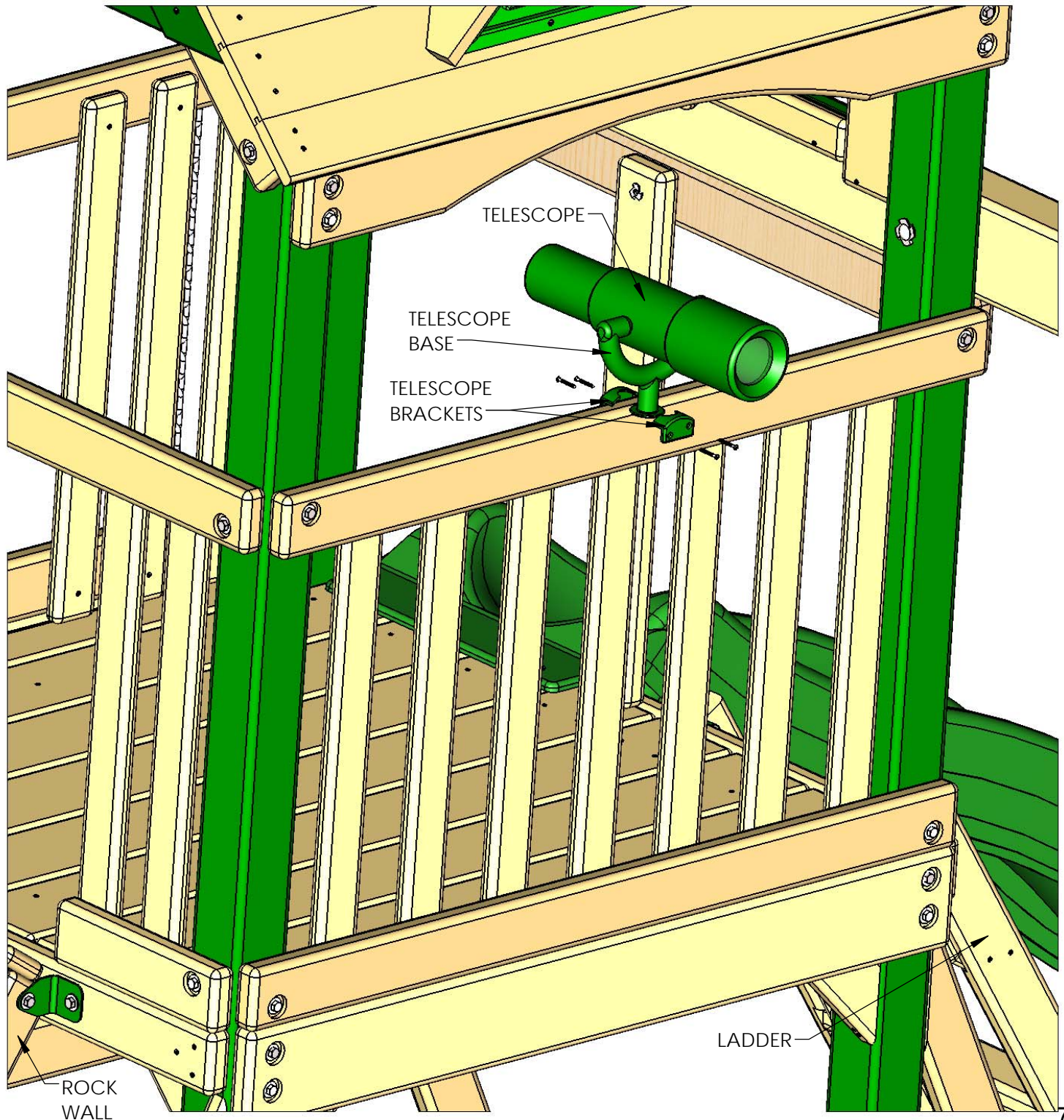

## STEP 44: FLAG KIT

- 1: PLACE THE FLAGS ON THE FRONT SIDE OF THE PLAY SET CENTERED ON THE CORNER POSTS.
- 2: ATTACH THE PLASTIC BASE OF EACH FLAG TO THE CORNER POST WITH THE 1/2" PHILLIPS HEAD SCREWS PROVIDED WITH THE FLAGS.

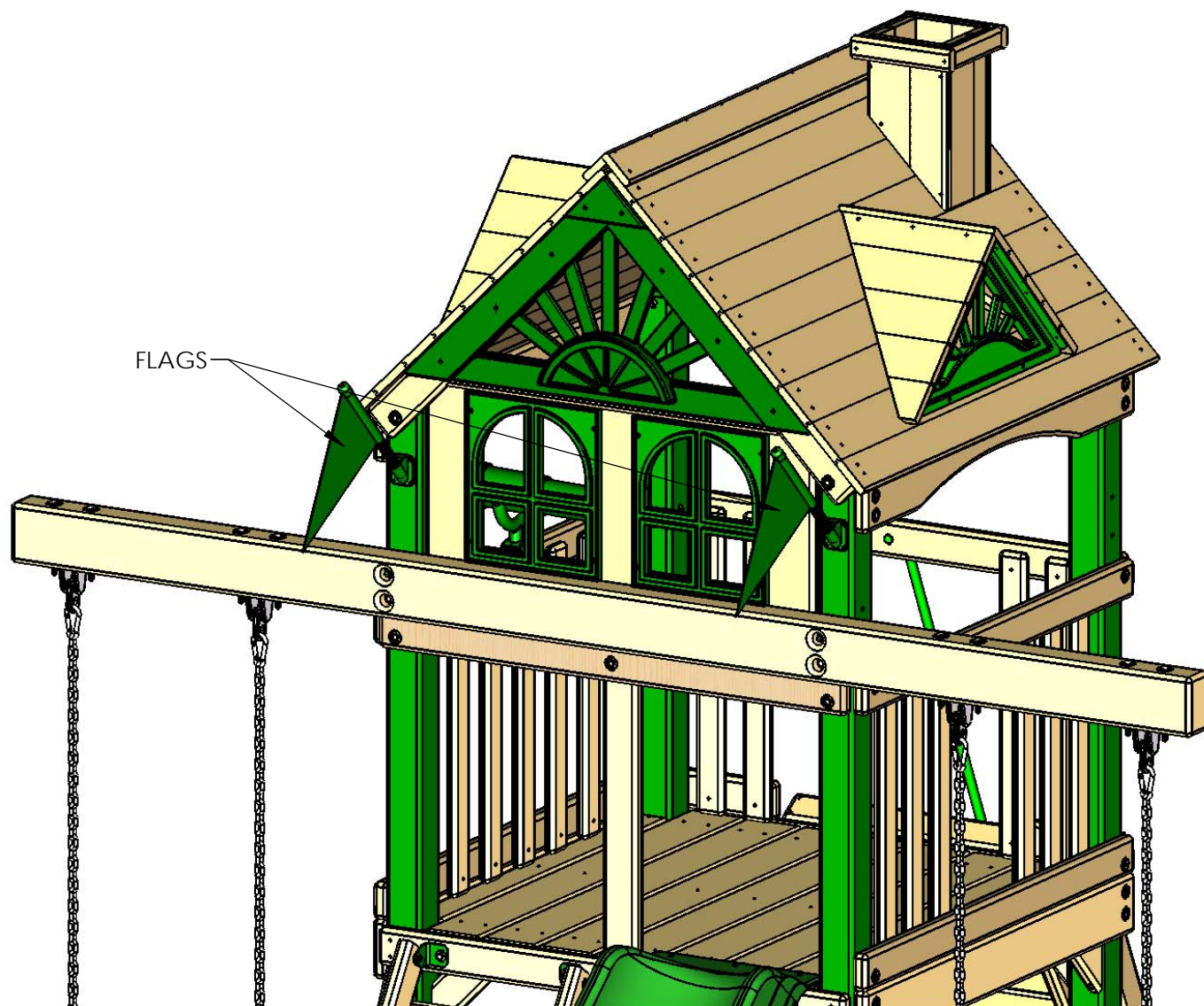

## STEP 45: SAFETY HANDLES

1: PLACE THE SAFETY HANDLES CENTERED ONTO THE CORNER POST AND CENTER POST ABOVE THE LADDER. ADJUST THE SAFETY HANDLES UP OR DOWN TO SUIT THE NEEDS OF YOUR CHILD.

2: ATTACH EACH SAFETY HANDLE WITH TWO 1-1/4" PAN HEAD SCREWS AND TWO 1/4" WASHERS PROVIDED WITH EACH SAFETY HANDLE.

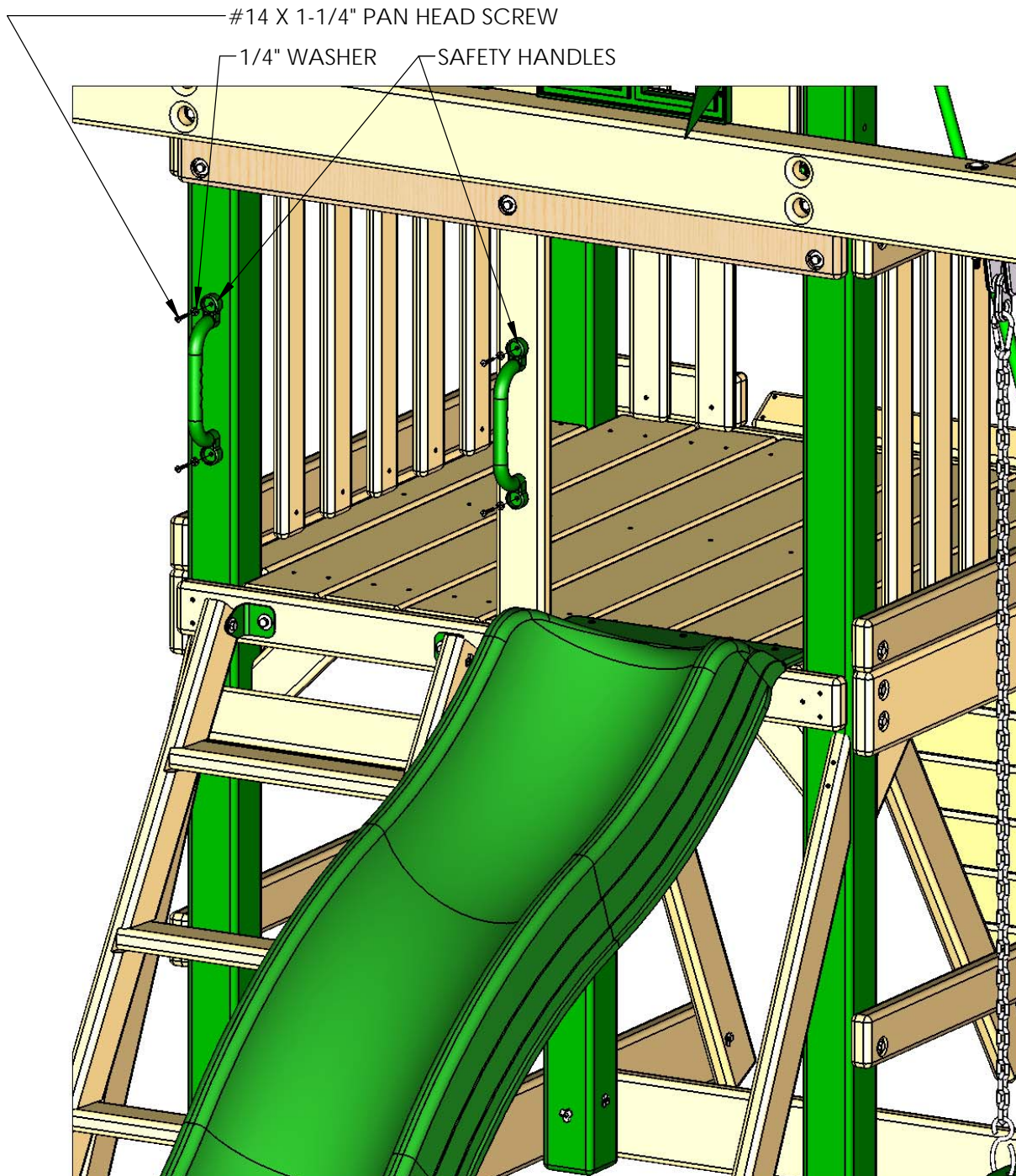

## STEP 46: TIC TAC TOE ASSEMBLY/INSTALLATION

- 1: LOCATE THE TIC TAC TOE BOX. FOLLOW THE INSTRUCTIONS IN THE BOX TO ASSEMBLE THE TIC TAC TOE OMITTING STEPS 6 AND 7.
- 2: LOCATE THE TWO 5/4 X 3 X 17-1/2" TIC TAC TOE MOUNTS.
- 3: USE THE SCREWS INCLUDED WITH THE TIC TAC TOE TO ATTACH THE GREEN BRACKETS TO THE TIC TAC TOE MOUNTS. EACH GREEN BRACKET SHOULD BE CENTERED OVER THE TIC TAC TOE MOUNT.
- 4: PLACE THE TIC TAC TOE AGAINST THE PANEL SLATS AT THE RIGHT SIDE OF THE PLAY SET ON THE INSIDE. THE BOTTOM TIC TAC TOE MOUNT SHOULD BE APPROXIMATELY 4" OFF THE DECK.
- 5: ATTACH THE TIC TAC TOE MOUNTS TO THE PANEL SLATS WITH #8 X 1-3/4" WOOD SCREWS.

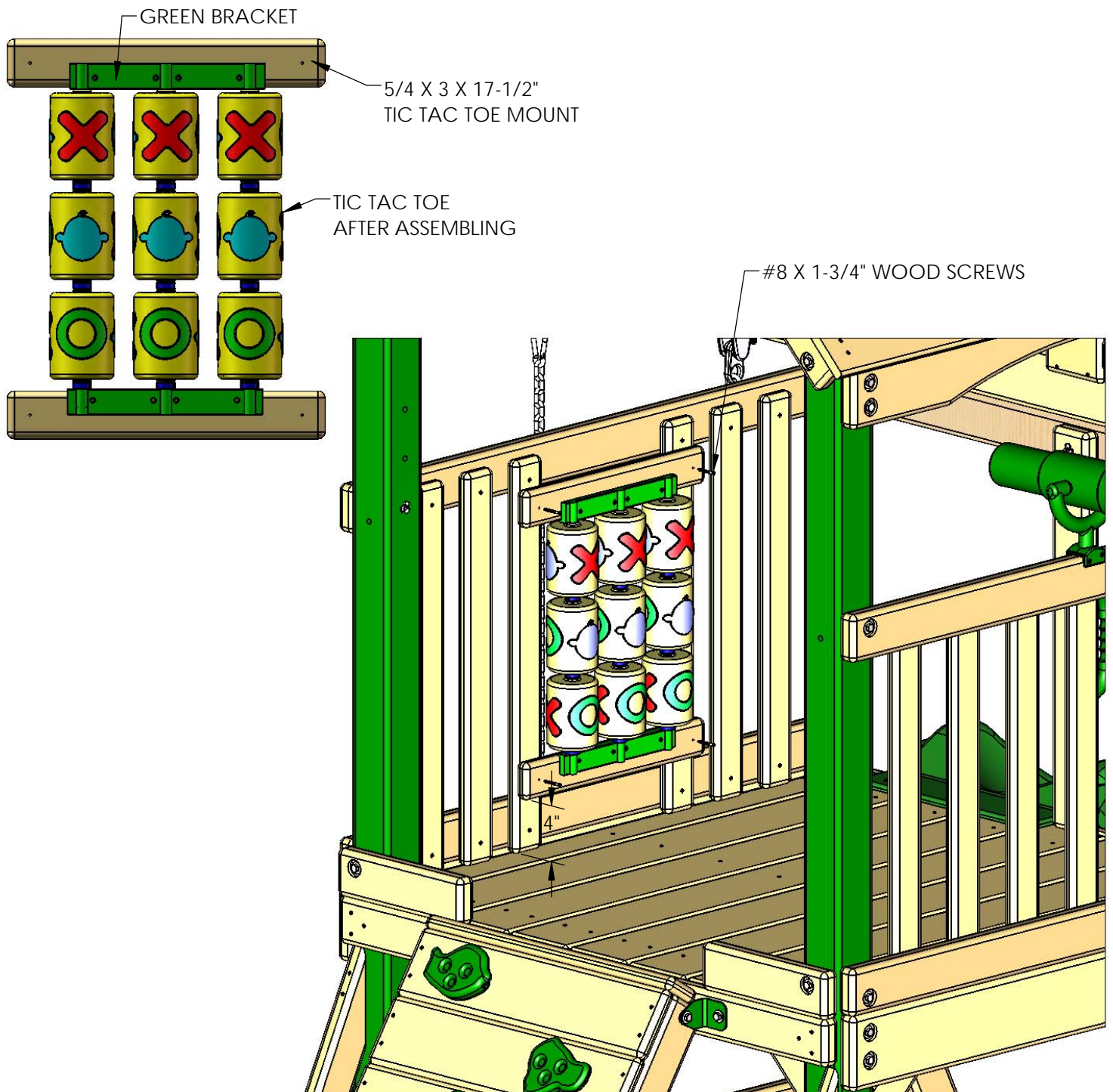

## STEP 47: NAME PLATE

1: ATTACH THE MANUFACTURER NAME PLATE TO THE MIDDLE OF THE SWING BEAM WITH TWO #8 X 2" WOOD SCREWS.



# Chalkboard (07-0018)

1. Chalkboard may be mounted with the checkerboard "horizontal" or "vertical".
2. Attach Chalkboard to wood slats or plywood with four of the 3/4" (20mm) long pan head screws provided.

Please note: Chalkboard comes with a magnetic chalk holder which will stick to the chalkboard. This chalk holder is not shown below.

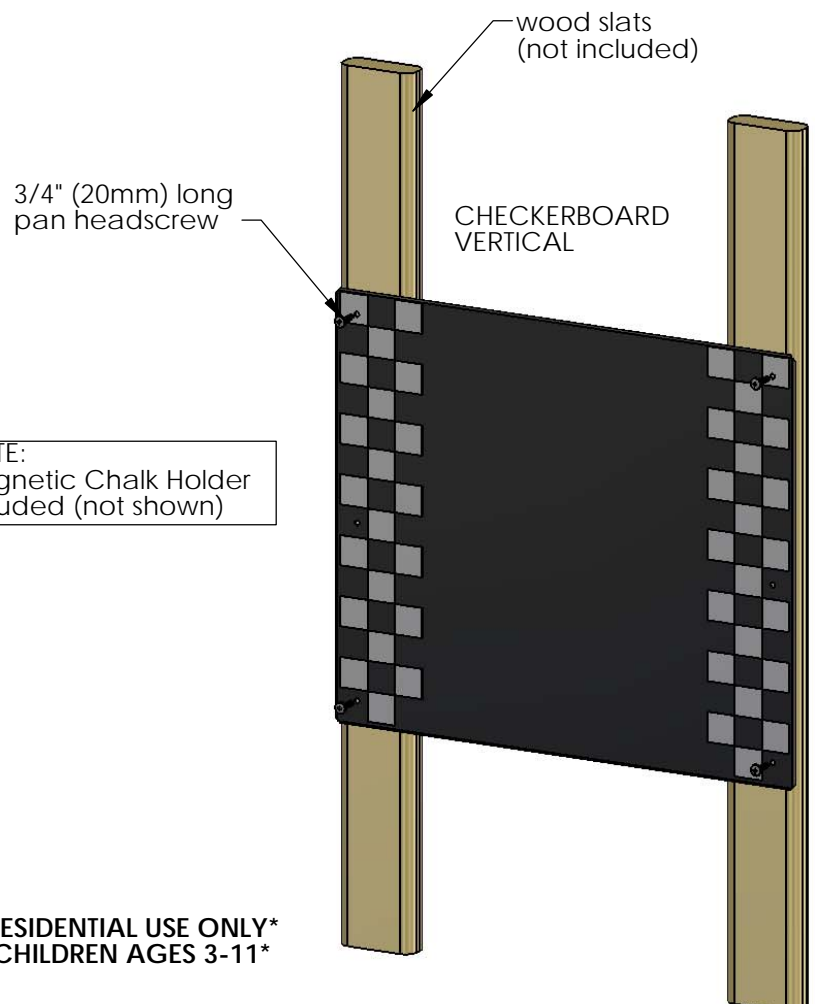
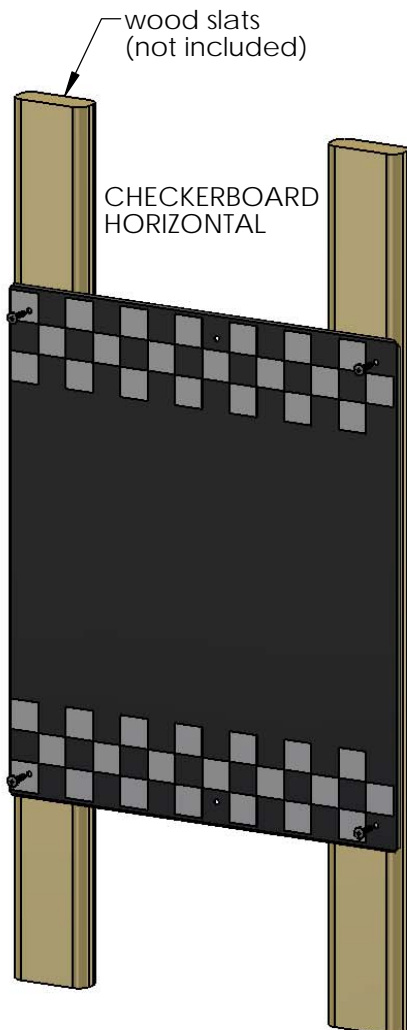
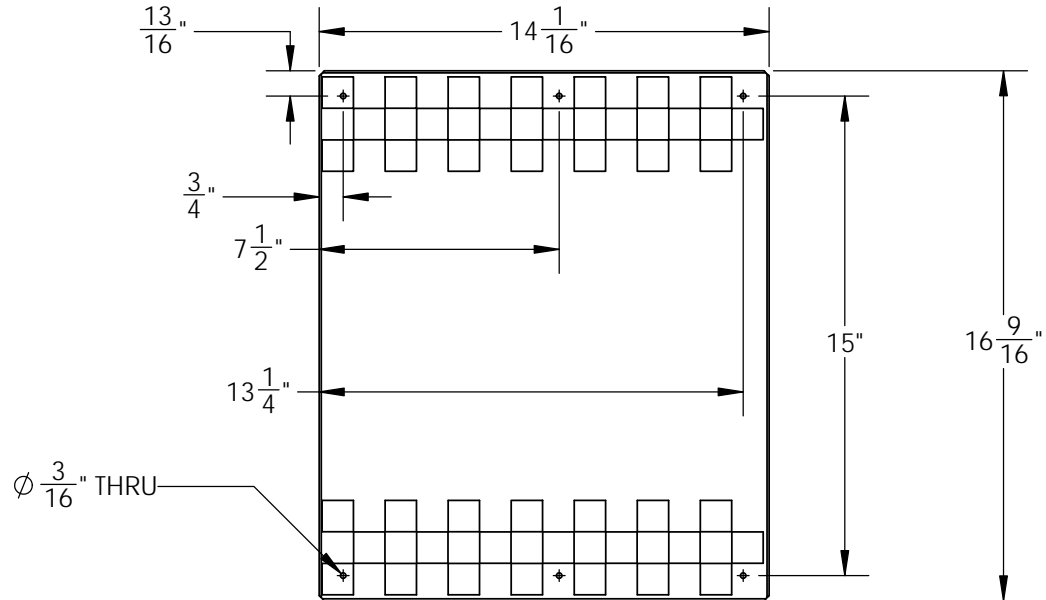

NOTE:  
Magnetic Chalk Holder  
included (not shown)

**\*FOR RESIDENTIAL USE ONLY\***  
**\*FOR CHILDREN AGES 3-11\***

# APPENDIX



Chimney and Dormers

Hardware Kit

8/10/2015 JH

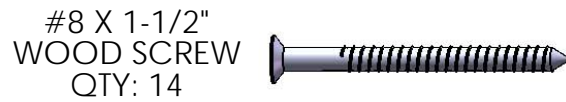
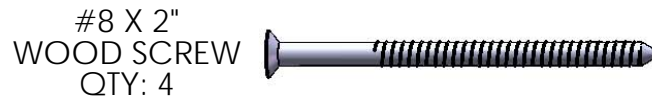

#2 SQUARE  
DRIVE BIT  
QTY: 1

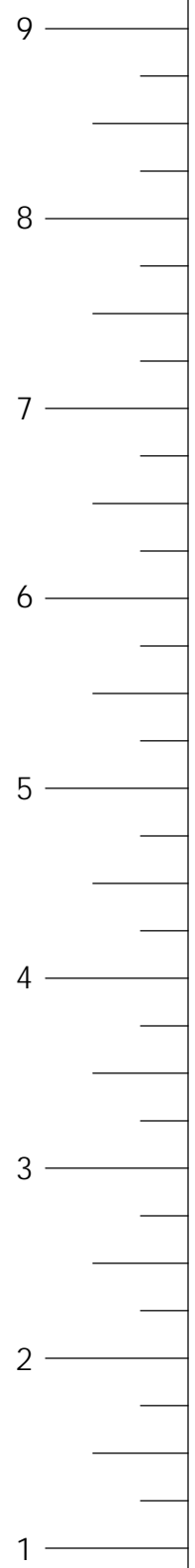

USE THE RULER TO THE RIGHT TO MEASURE YOUR BOLTS AND SCREWS. PICTURE VIEWS SHOWN ABOVE ARE 1:1 SCALE AND CAN BE USED TO MATCH BOLT AND SCREW SIZES.

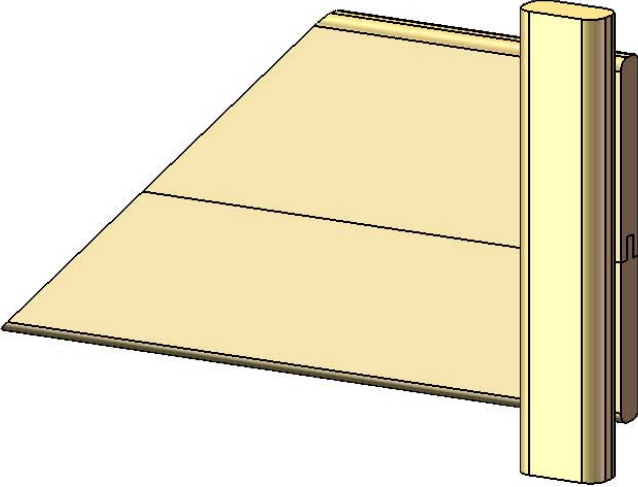
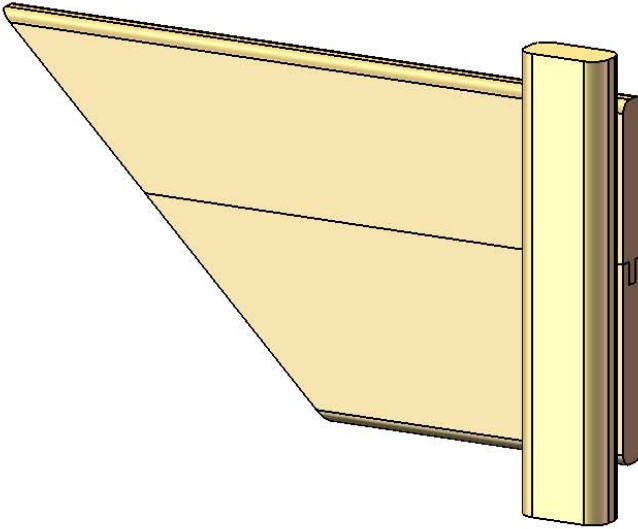
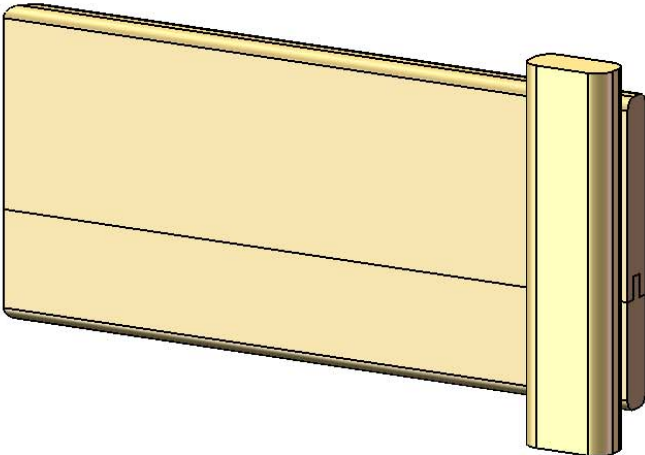
PICTURE	DESCRIPTION	QTY.
	CHIMNEY LEFT SIDE ASSEMBLY	1
	CHIMNEY RIGHT SIDE ASSEMBLY	1
	CHIMNEY FRONT ASSEMBLY	1

PICTURE

DESCRIPTION

QTY.

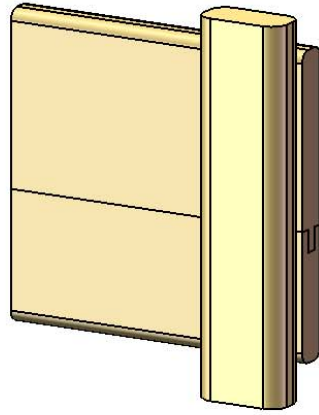

CHIMNEY  
REAR  
ASSEMBLY

1

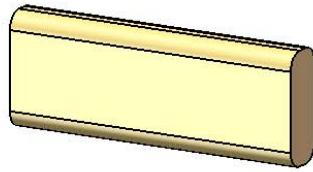

5/4X3X6-3/4"  
CHIMNEY  
MOUNTING  
BLOCK

1

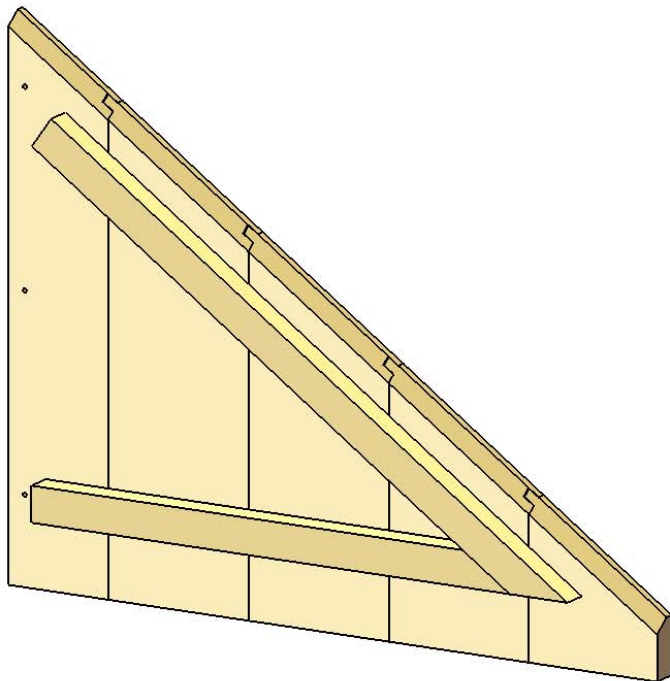

DORMER  
LEFT SIDE  
ASSEMBLY

2

PICTURE

DESCRIPTION

QTY.

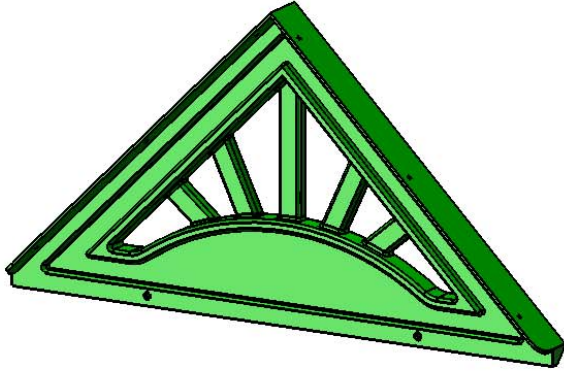

PLASTIC  
DORMER  
SUNBURST  
(07-0031)

2

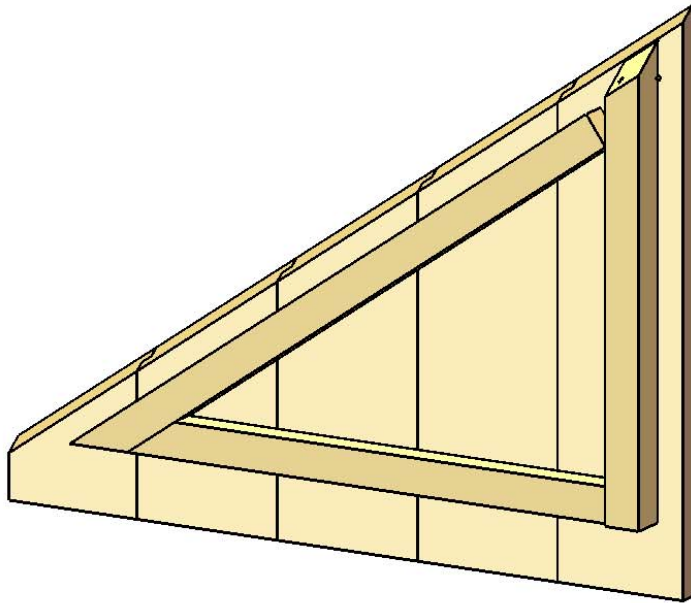

DORMER  
RIGHT SIDE  
ASSEMBLY

2

# STEP 1: DORMER

- 1: OVERLAP THE LEFT DORMER SIDE ONTO THE PEAK SUPPORT OF THE RIGHT DORMER SIDE.
  - 2: MAKE SURE THE FRONT ROOF EDGES ARE FLUSH TO ONE ANOTHER
  - 3: FASTEN THE LEFT DORMER SIDE TO THE PEAK SUPPORT WITH #8 X 1-1/2" WOOD SCREWS.
- REPEAT SUBSTEPS 1-3 TO CONSTRUCT ANOTHER ROOF ASSEMBLY.

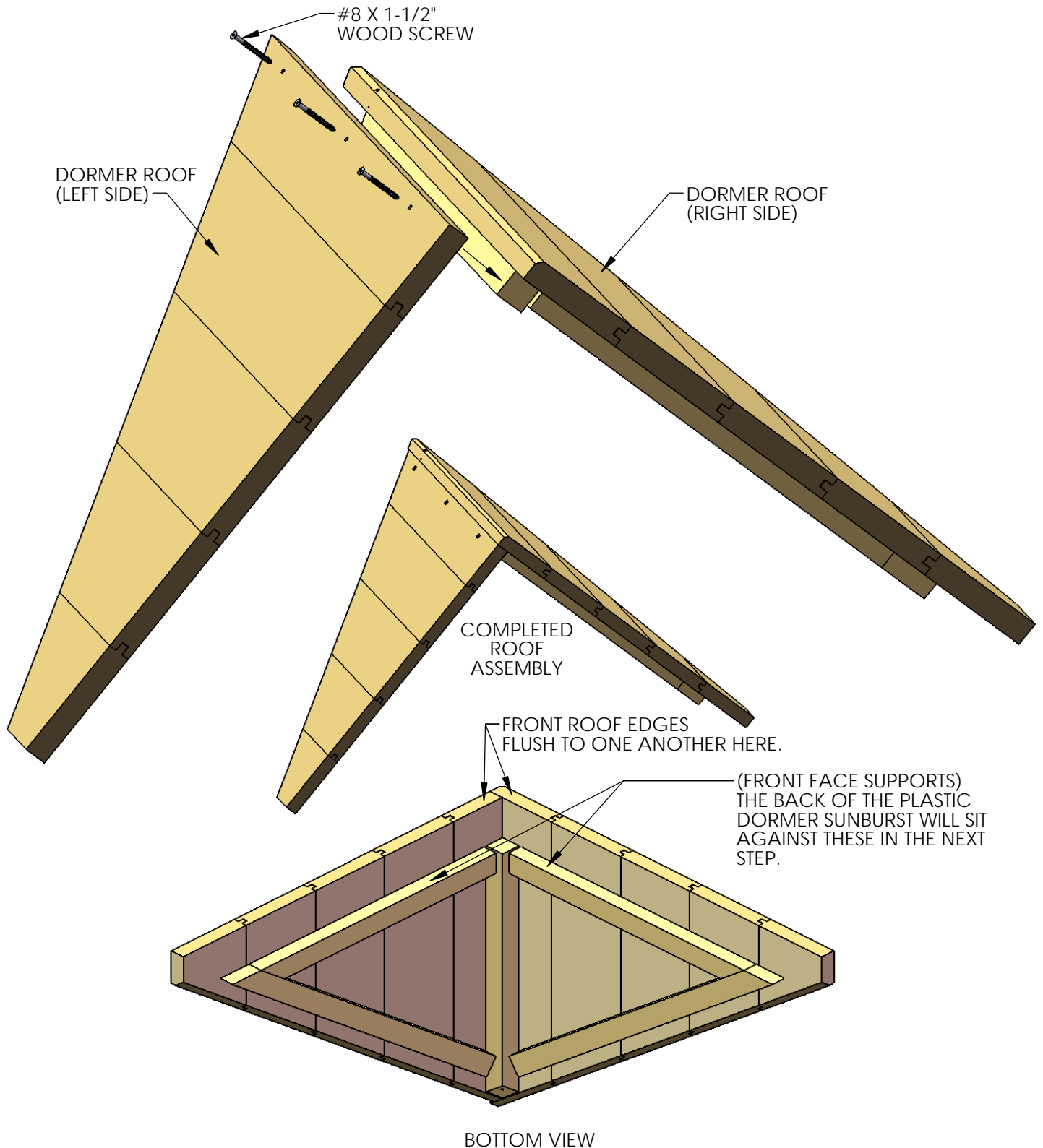

## STEP 2: DORMER

- 1: PLACE THE PLASTIC DORMER SUNBURST AGAINST THE FRONT FACE SUPPORT ON THE LEFT AND RIGHT ROOF SIDES.
  - 2: PREDRILL  $7/64$ " PILOT HOLES BY  $1/2$ " DEEP INTO THE ROOF SIDES AT EACH HOLE LOCATION.
  - 3: INSTALL #8 X  $1/2$ " PAN HEAD SCREWS TO FASTEN THE SUNBURST TO THE ROOF SIDES.
- REPEAT SUBSTEPS 1 THROUGH 3 TO CONSTRUCT THE SECOND DORMER.

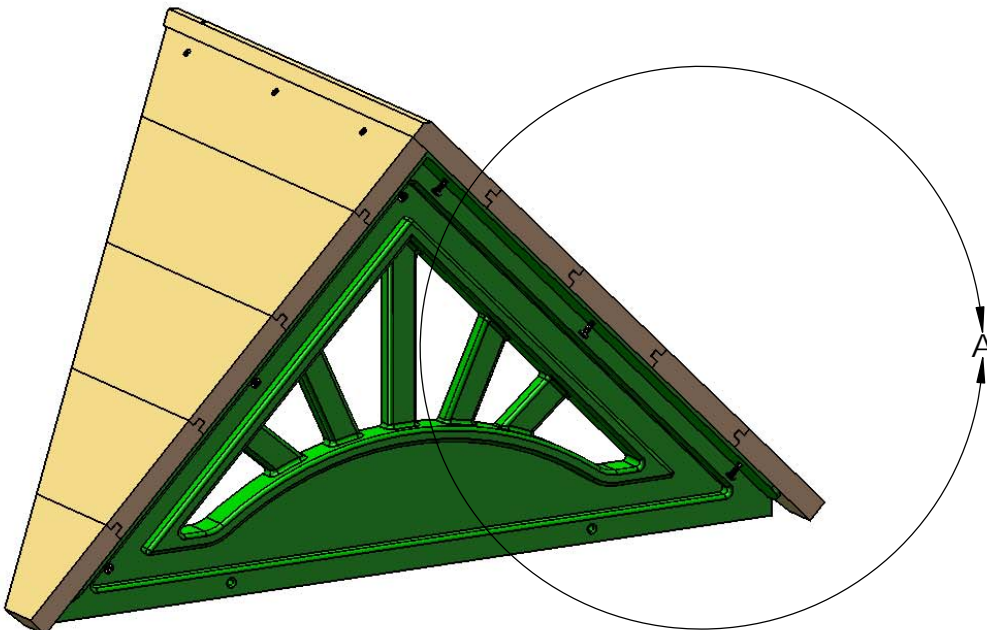
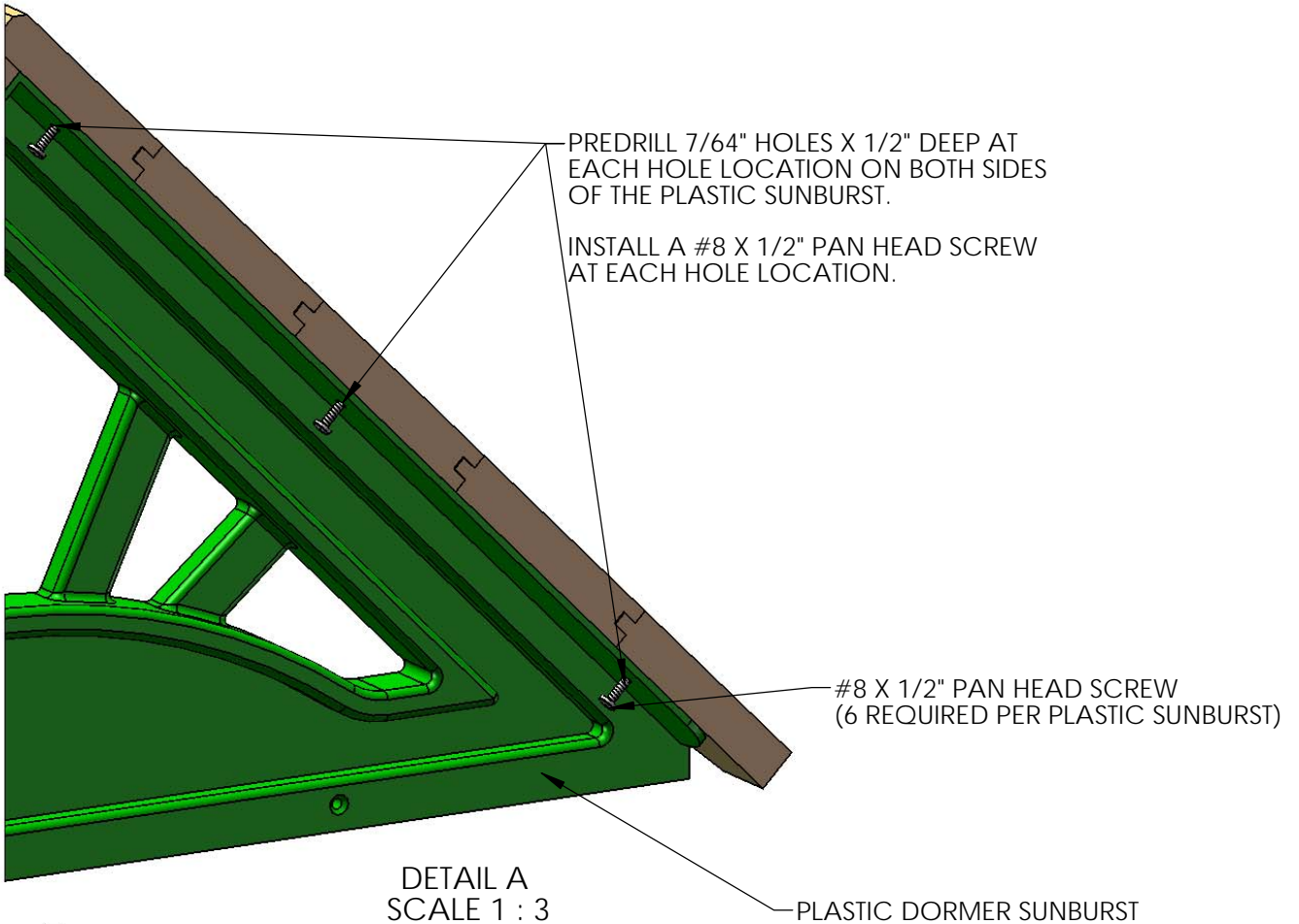

## STEP 3: DORMER

1: PLACE THE DORMER ASSEMBLY ON THE ROOF AS SHOWN.

2: FOR 1500 SERIES UNITS LINE UP THE BOTTOM EDGE OF THE PLASTIC SUNBURST WITH THE LOWER EDGE OF THE 8TH ROOF BOARD.

3: CENTER THE DORMER FROM SIDE TO SIDE ON TOP OF THE ROOF.

4: ATTACH THE DORMER TO THE ROOF WITH ONE #8 X 2-1/2" WOOD SCREW AT THE REAR PEAK OF THE ROOF. ATTACH THE DORMER SUNBURST TO THE ROOF WITH TWO #8 X 1-1/2" WOOD SCREWS.

REPEAT SUBSTEPS 1 THROUGH 4 FOR THE DORMER ON THE OTHER SIDE OF THE ROOF.

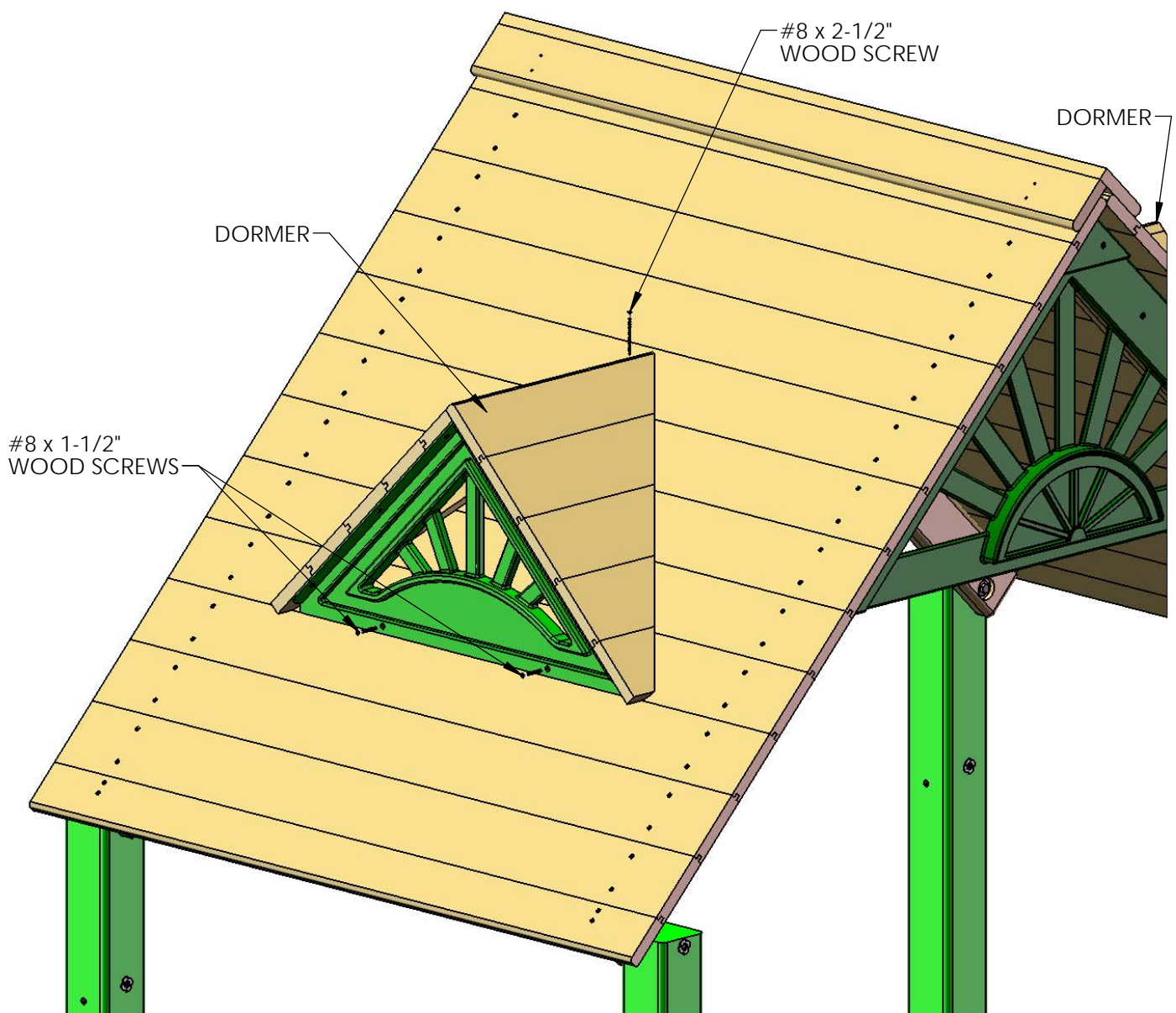

THE UNIT SHOWN ABOVE MAY NOT BE YOUR EXACT PLAY SET.  
SHOWN FOR ILLUSTRATION PURPOSES ONLY.

## STEP 4: CHIMNEY

1: FIND THE FRONT AND LEFT SIDE OF THE CHIMNEY.

2: ATTACH THE FRONT AND LEFT SIDES OF THE CHIMNEY WITH A 2" WOOD SCREW.

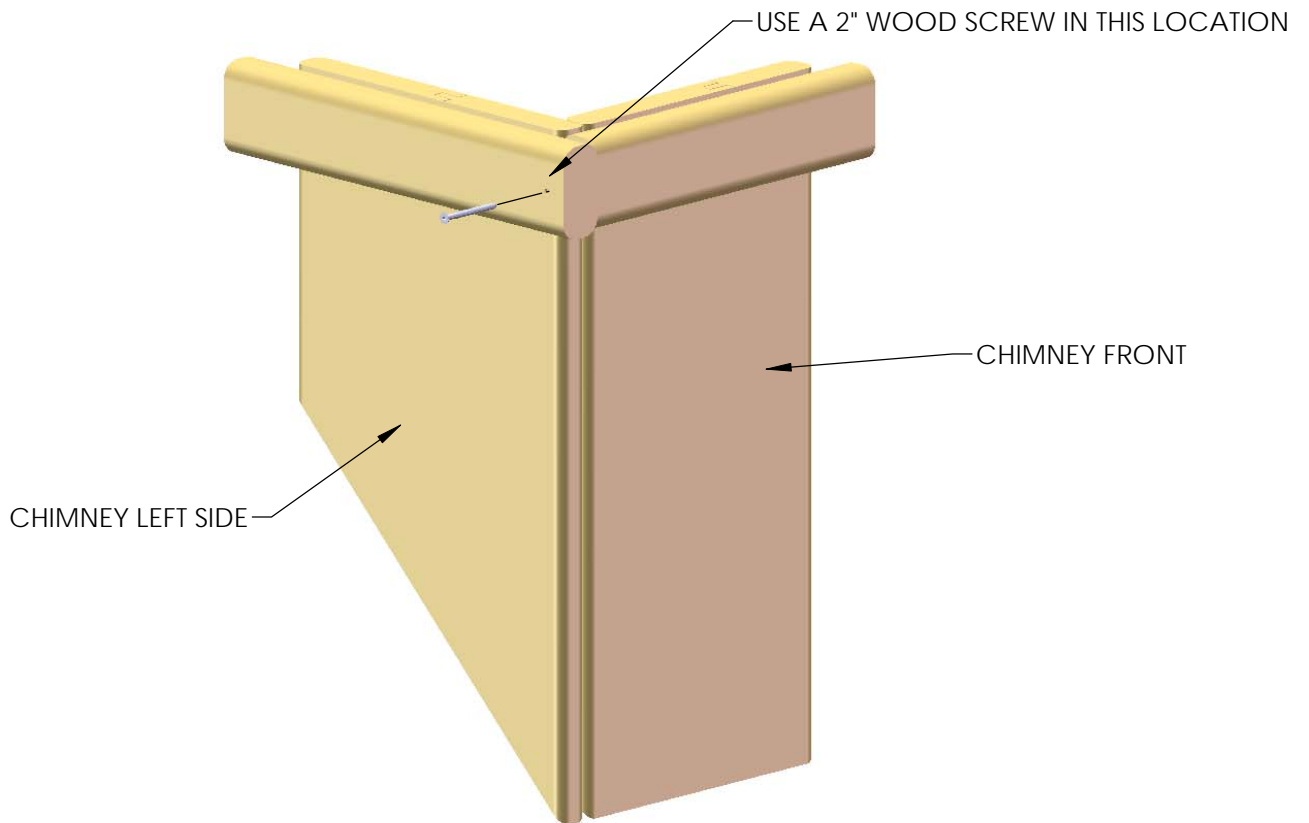

1: FIND THE REAR AND RIGHT SIDE OF THE CHIMNEY.

2: ATTACH THE REAR AND RIGHT SIDES OF THE CHIMNEY WITH A 2" WOOD SCREW.

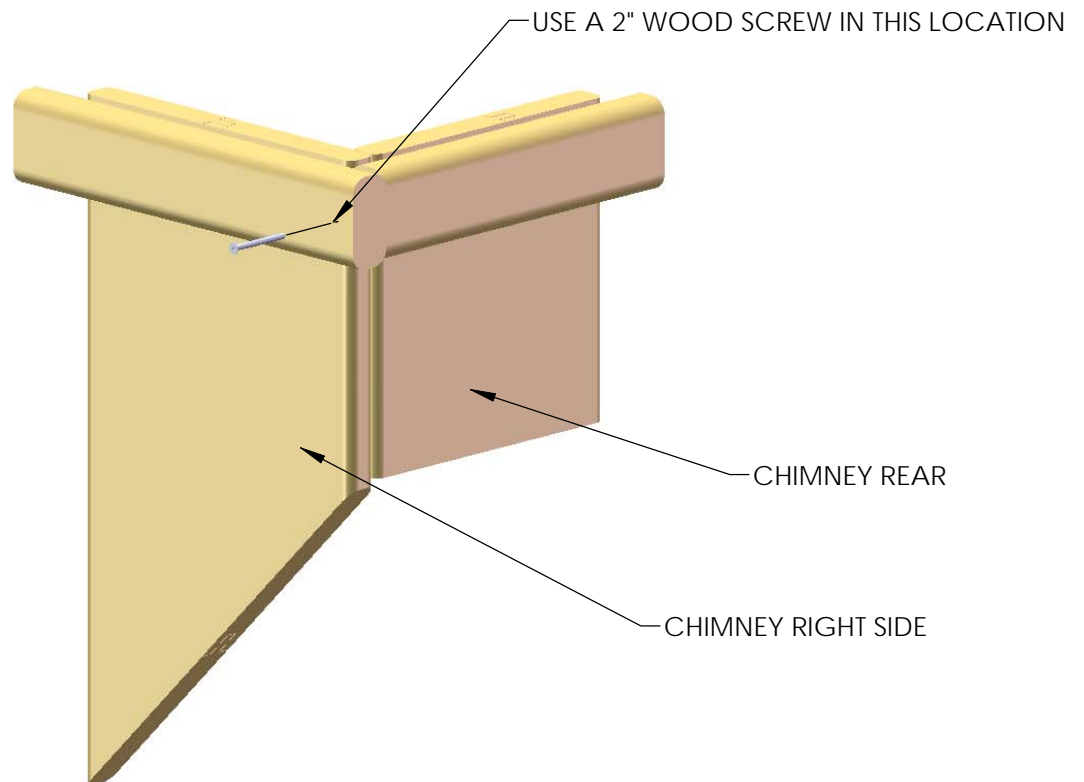



## STEP 5: CHIMNEY

1: ATTACH THE CHIMNEY SIDES FROM THE PREVIOUS SIDES TO FORM THE CHIMNEY WITH 2" AND 1-1/4" WOOD SCREWS.

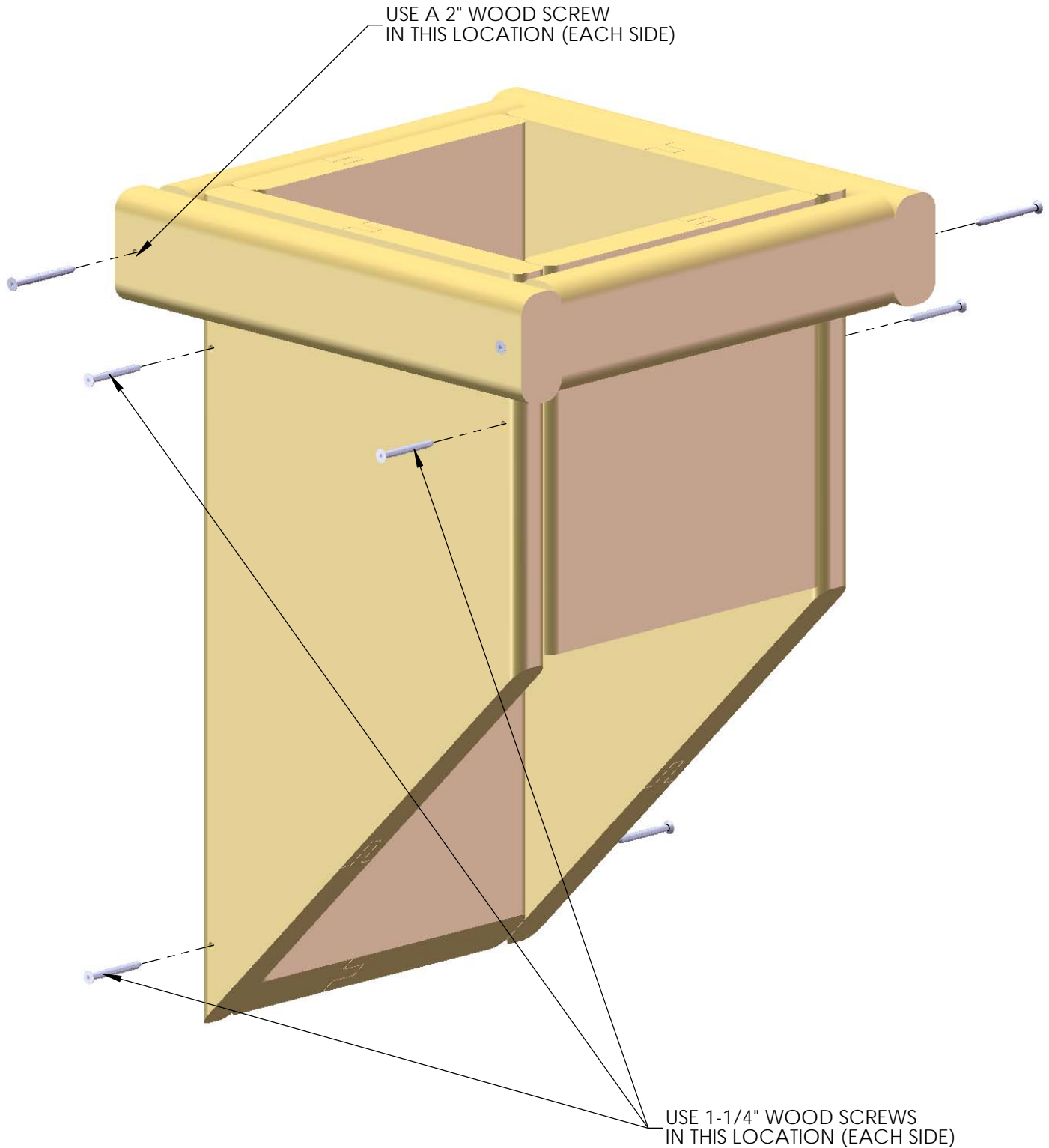

## STEP 6: CHIMNEY

- 1: FASTEN THE 5/4 X 3 X 6-3/4" CHIMNEY MOUNTING BLOCK TO THE ROOF WITH #8 X 1-1/2" WOOD SCREWS. YOU CAN PLACE THE BLOCK AT ANY DESIRED PLACE ON THE ROOF. USE THE DIAGRAM BELOW AS A GUIDE FOR A SUGGESTED PLACE TO MOUNT THE CHIMNEY.
- 2: AFTER INSTALLING THE CHIMNEY MOUNTING BLOCK PLACE THE CHIMNEY ASSEMBLY ON THE ROOF SO THAT THE INSIDE OF THE BACK WALL RESTS AGAINST THE BLOCK.
- 3: FASTEN THE CHIMNEY TO THE CHIMNEY MOUNTING BLOCK WITH A #8 X 1-1/2" WOOD SCREW IN EACH SIDE.

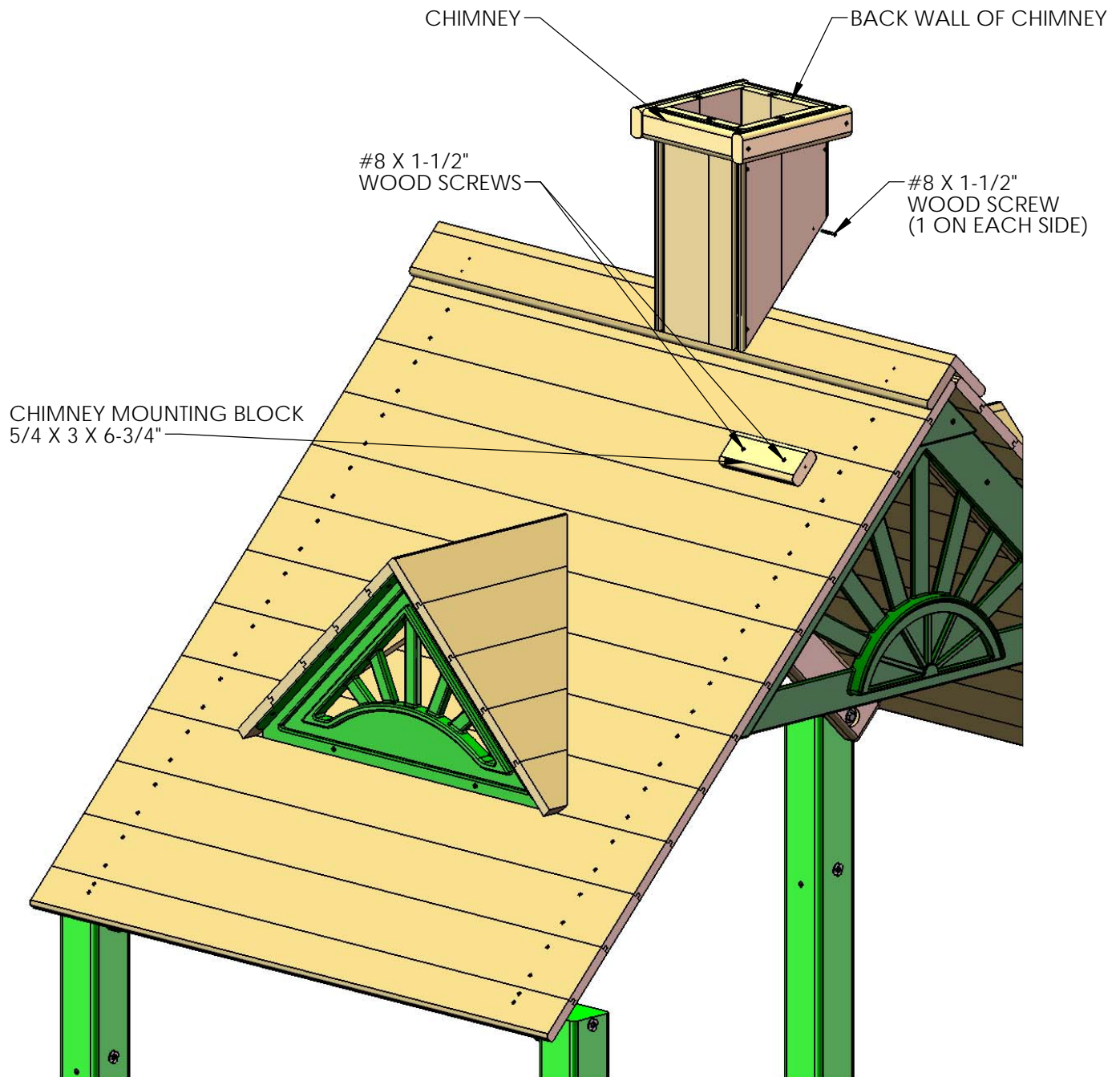

THE ABOVE UNIT MAY NOT BE YOUR EXACT PLAY SET.  
SHOWN FOR ILLUSTRATION PURPOSES ONLY.