



Monkey Bar Add On - Assembly Manual

Applications: Sun Valley or Sun Palace Playsets

Copyright © 2011 Gorilla Playsets
All Rights Reserved

Gorilla Playsets • 190 Etowah Industrial Court • Canton, GA 30114 • (800) 882-0272

Latest Revision: September 7, 2011

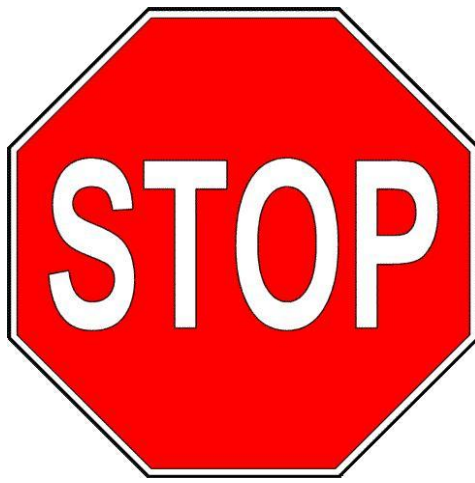

STOP...PLEASE READ!!

IF YOU HAVE MISSING OR DAMAGED PARTS OR NEED ASSISTANCE ASSEMBLING, PLEASE CALL **gorilla playsets™ MANUFACTURING DIRECT.**

(800) 882-0272

FACTORY HOURS – MON.–FRI., 8AM-5PM EST

DO NOT RETURN THIS PRODUCT TO THE RETAILER OR CONTACT THE RETAILER DIRECT. THE RETAILER DOES NOT STOCK COMPONENTS.

PLEASE RETAIN THESE INSTRUCTIONS FOR FUTURE REFERENCE. KEEP THEM IN A SAFE PLACE WHERE YOU CAN REFER TO THEM AS NEEDED.

CONTACT INFO:

Gorilla Playsets
190 Etowah Industrial Court
Canton, GA 30114
Tel. (678) 880-3328
Fax. (678) 880-3329
custsrv@gorillaplaysets.com

Check for revised instructions at www.gorillaplaysets.com/support



Monkey Bar Add On

TABLE OF CONTENTS

Warranty and Safety Guidelines.....	4-10
Kit Contents and Tool List.....	11-15
Hardware and Lumber Checklist.....	16-17
Assembling the Ladder.....	Step 1
Assembling the Monkey Bar Assembly.....	Step 2
Attaching the Ladder to the Monkey Bar Assembly.....	Step 3
Attaching the Monkey Bar Unit to the playset.....	Step 4
Attaching the Monkey Bar Supports.....	Step 5
Reattaching the Panel Slats.....	Step 6
Attaching the Safety Handles.....	Step 7

**PLEASE READ OWNER'S MANUAL CAREFULLY BEFORE
STARTING ASSEMBLY!**

Thank you for choosing **gorilla playsets®** for your new backyard playground!

We've included everything you need, except tools, to build your very own professional looking playset. When complete, your new playset should far exceed the quality of playset kits from other build-your-own companies. Our engineers and design team have over 30 years of playground experience. What we've developed is a playset that doesn't compromise quality for simplicity. Yet you'll appreciate how quick and easy construction really is! Our playset kits are designed for children ages 3 to 11. **gorilla playsets®** believes every child should have a playset and with our kits they can! You can rest assured your new playset is safe, durable and designed to hold up to the elements. As parents ourselves, we know how important the security and well-being of our children is, and this shows in all of our products.

Each playset features our step-by-step 3D illustrated manual, patented powder coated swing beam bracket, heavy-duty swing belts with chains, slide(s), accessories, plus all the required hardware and pre-milled lumber.

Quality Lumber

At Gorilla Playsets, we use only the finest, hand selected lumber available. Whether you choose a playset made from our Premium Preserved Pine, Beautiful California Redwood, Western Red Cedar, or Asian Cedar you can be assured that our lumber is strong, durable, and conforms to the national standards for use in children's play equipment. It's this quality that allows us to offer a 10 year warranty on the lumber used in our play sets.

Premium Preserved Pine

Our Premium Preserved Pine is double kiln dried. We utilize this process to minimize shrinkage, warping, and cupping. Because our pine has been "pre-shrunk", the hardware used to assemble your playset will hold tight. Our preserved pine is clean, odorless, non-staining, and non-irritating to humans, animals, or plants. Gorilla's Preserved Pine uses one of the only exterior wood preservation systems that is EPA approved. Our pine lumber is preserved with a preservative system containing copper and azole compounds to protect against termite attack and fungal decay. Our Premium Preserved Pine can withstand harsh weather conditions and is effective for decades; making Gorilla Playsets the best choice in pine lumber built swing sets.

California Redwood and Western Red Cedar*

Our Beautiful California Redwood and Western Red Cedar playsets are a natural alternative to preserved lumber. California Redwood naturally resists decay caused by the environment or by insect infestation while Western Red Cedar is a preferred wood for purposes where an attractive appearance and resistance to weather is important. All California Redwood and Western Red Cedar Gorilla Playsets receive a factory stain and sealant process. To maintain this aesthetic appeal, it is recommended that you seal your redwood and cedar play set once per year.

Asian Cedar (*Cunninghamia Lanceolata*)

Our durable Asian Cedar playsets are low-maintenance, and maintain their beauty for many years. Asian Cedar has been harvested in Southeast Asia for more than 800 years, and is prized because it naturally repels pests, fungus, and rot. Asian Cedar is used indoors and out where durability is critical. Asian Cedar can be found throughout the U.S. in outdoor lawn furniture, and on children's play structures.

*Gorilla Playsets reserves the right to substitute Western Red Cedar with other species of similar characteristics due to market availability.

Limited Manufacturers Warranty

gorilla playsets® warrants this product to be free from defects in workmanship and materials, under normal use and conditions, for a period of 10 years for structural wood components and one year for all other components (i.e., hardware, plastics, tarps, rope ladder, etc.). Cosmetic defects that do not affect the structural integrity of the product, or natural defects of wood such as warping, checking or any other physical properties of wood that do not present a safety hazard, are not covered by this warranty.

gorilla playsets® will repair, or, at its discretion, replace any part within the stated warranty period that is defective in workmanship or materials. This decision is subject to verification of the defect upon delivery of the defective part to **gorilla playsets®** at 190 Etowah Industrial Court, Canton, Georgia 30114. Any part(s) returned to **gorilla playsets®** must include proof and date of purchase.

This warranty is valid only if the product is used for the purpose for which it was designed and installed at a residential, single-family dwelling. This warranty is void if the product is put to commercial or institutional use. This warranty does not cover (a) products which have been damaged by negligence, natural disasters, or accident by improper use, or which have been modified or repaired by unauthorized persons, (b) the cost of labor, or (c) the cost of shipping the product, any part, or any replacement product or part.

This warranty is valid only in the United States of America, is non-transferable and does not extend to the owners of the product subsequent to the original purchaser. **gorilla playsets®** disclaims all other representations and warranties of any kind, express, implied, statutory or otherwise, including the implied warranties of merchantability and fitness for a particular purpose. **gorilla playsets®** will not be liable for any incidental or consequential damages. Some states do not allow limitations on implied warranties or exclusion of incidental or consequential damages, so these restrictions may not be applicable to you. This warranty gives you specific legal rights. You may also have other rights that vary from state to state.

IMPORTANT SAFETY GUIDELINES

This product is intended for residential use only and not intended for use in any public setting. A safety surface such as mulch or recycled tire should be used under the play set to prevent injury from falls. Also a 6 foot safety zone should be used around the entire playset.

As with any home project, good judgment and respect for power tools will greatly reduce the risk of injury. **gorilla playsets®** recommends you follow all tool manufacturers' safety guidelines. Always wear eye protection and safety gloves to prevent injury. In several phases of construction two people may be required for lifting and securing of lumber. While playset is being constructed, please keep children off the equipment until the project is complete. Bolts and screw heads should be checked regularly for tightness. The ground ladder, rope ladder, slide, swings and other areas where children spend a majority of their playtime should be checked more frequently.

gorilla playsets® shall not be liable for incidental, indirect or consequential damages or injuries that result from the building and/or playing on our playsets. Adult supervision is recommended anytime a playset is being used.

WEIGHT LIMITS FOR GORILLA PLAYSETS

- FORT PLATFORMS: 800 LBS. TOTAL WEIGHT
- SWING BELTS: 225 LBS.
- GLIDER SWINGS: 70 LBS. PER CHILD (UP TO 140 LBS TOTAL)
- TRAPEZE: 125 LBS.
- FULL BUCKET SWING: 75 LBS.
- HALF BUCKET SWING: 75 LBS.
- INFANT SWING: 35 LBS.
- TIRE SWING: 125 LBS. TOTAL WEIGHT
- ROPE LADDER: 75 LBS.
- ROCK WALL: 150 LBS.
- MONKEY BAR: 125 LBS.

Gorilla Playsets recommends that the weight limits for all components must not be exceeded. Failure to adhere to these and other safety guidelines could result in damage to the play set and injury to the users.

Safety and Maintenance Tips for Your New Play Set:

NOTE: Your children's safety is our #1 concern. Observing the following statements and warnings reduces the likelihood of serious or fatal injury. Please review these safety rules regularly with your children.

- This play set is designed for the use of 4 occupants who have a combined weight **not exceeding** 800 pounds on the elevated floor, 3 occupants who have a combined weight of 525 pounds on the swing area, for a total Unit capacity of 5 occupants who have a combined weight of 1325. (this weight is not including the picnic table area)
- On-site adult supervision is **required**.
- Teach children **not** to walk close to, in front of, behind, or between moving swings or other moving playground equipment.
- Teach children to sit in and **never** stand on swings
- Teach children **not** to twist the chains and ropes and not to loop them over the swing beam, since this may reduce the strength of the chain or rope.
- Teach children **not** to jump from swings or other playground equipment in motion.
- Teach children to **not push** empty seats. The seat may hit them and cause serious injury.
- Teach children to sit in the center of the swings with their full weight on the seats.
- Teach children **not** to use the equipment in a manner other than intended.
- Teach children to **always** go down slides feet first. Never slide headfirst.
- Teach children to **look** before they slide to make sure no one is at the bottom.
- Teach children to **never** run up a slide, as this increases their chances of falling.
- The parents should have the children **dress appropriately** with well-fitting shoes. Loose clothing such as scarves and ponchos should not be worn. Always take off, tie up or tuck in cords and drawstrings on children's clothing. These things can get caught on playground equipment and strangle a child.
- Teach children **not** to climb when the equipment is wet.
- Teach children to **never** jump from a fort deck. They should always use the ladder, ramp or slide.
- Teach children to **never** crawl or walk across the top of monkey bars.
- Teach children to **never** crawl on top of a fort roof.
- Verify that any suspended climbing ropes, chains, or cables are secured at both ends and that they cannot be looped around an adult hand.
- Teach children **not** to attach items to the playground equipment that are not specifically designed for use with the equipment, such as, but not limited to, jump ropes, clothesline, pet leashes, cables and chain as they may cause a strangulation hazard.
- Teach children to **never** wrap their legs around swing chain.
- Teach children to **never** slide down the swing chain.

WARNING: Children must NOT use this play set until unit has been completely assembled and inspected by an adult to insure set has been properly installed and anchored.

Safety and Maintenance Tips for Your New Play Set: (continued)

Playgrounds should be inspected on a regular basis. If any of the following conditions are noted, they should be removed, corrected, or repaired immediately to prevent injuries.

- Hardware that is loose, worn or that has protrusions or projections.
- Exposed equipment footings.
- Scattered debris, litter, rocks, or tree roots.
- Splinters, large cracks, and decayed wood components.
- Deterioration and corrosion on structural components, which connect to the ground
- Missing or damaged equipment components, such as handholds, guardrails, swing seats.
- Check all nuts and bolts frequently during the usage season and tighten as required. (But not so tight that you crack the wood) We recommend you check the swing beam and hardware often due to wood expansion and contraction. It is particularly important that this procedure be followed at the beginning of each season.
- Remove plastic swing seats and take indoors or do not use when the temperature drops below 32°F.
- Oil all metallic moving parts monthly during the usage period.
- Check all coverings for bolts and sharp edges twice monthly during usage season to be certain they are in place. Replace when necessary. It is especially important to do this at the beginning of each new season.
- Check swing seats, ropes, cables and chains monthly during usage season for evidence of deterioration. Replacement should be made of any swing seat that has developed cracks in the plastic seats or has exposed metal in the edges of the swing seat. If there are already exposed metal inserts on the edge of the seat, immediately remove the seats and chains to prevent serious injury. Ropes, cables and chains should be removed and replaced if excessive wear is found. Contact Gorilla for warranted replacement parts.
- For rusted areas on metallic members such as monkey bars, hand supports brackets, etc.; sand and repaint, using a non lead-based paint meeting the requirements of Title 16 CRF Part 1303.
- Inspect wood parts monthly. The grain of the wood sometimes will lift in the dry season causing splinters to appear. Light sanding may be necessary to maintain a safe playing environment. If you are treating your play set with stain regularly, it will help prevent severe checking/splitting and other weather damage.
- Once or twice a year, depending on your climate conditions, you must apply some type of protection (sealant) to the wood of your unit. Prior to the application of sealant, lightly sand any "rough" spots on your set. Please note this is a requirement of your warranty.
- Creating and maintaining the play set on a level location is very important. As your children play, your play set will slowly dig its way into the soil, and it is very important that it settles evenly. Make sure the play set is level and true once each year or at the beginning of each play season.
- Rake the playground surface periodically to prevent compaction and maintain appropriate depths.

Disposal Instructions: When the play set use is no longer desired, it should be disassembled and disposed of in such away that no unreasonable hazards will exist at the time the unit is discarded.

Play Set Surfacing Recommendations:

Below are some of the recommendations that the U.S. Consumer Product Safety Commission (CPSC) offers from its *Handbook for Public Playground Safety*. The guide can be downloaded in full at www.cpsc.gov/cpscpub/pubs/325.pdf

1. Protective Surfacing - Since almost 60% of all injuries are caused by falls to the ground, protective surfacing under and around all playground equipment is the most critical safety factor on playgrounds.

Certain manufactured synthetic surfaces also are acceptable; however, test data on shock absorbing performance should be requested from the manufacturer.

Asphalt and concrete are unacceptable. They do not have any shock absorbing properties. Similarly, grass and turf should not be used. Their ability to absorb shock during a fall can be reduced considerably through wear and environmental conditions.

Certain loose-fill surfacing materials are acceptable. Surfacing materials are acceptable, such as the types and depths shown in the table.

Fall Heights and Materials

Material	Uncompressed Depth			Compressed Depth to 9" (228mm)
	6" (152mm)	9" (228mm)	12" (304mm)	
Wood Chips	7' (2.13m)	10' (3.05m)	11' (3.35m)	10' (3.05m)
Double-Shredded bark mulch	6' (1.83m)	10' (3.05m)	11' (3.35m)	7' (2.13m)
Engineered Wood Fibers	6' (1.83m)	7' (2.13m)	>12' (3.66m)	6' (1.83m)
Fine Sand	5' (1.52m)	5' (1.52m)	9' (2.74m)	5' (1.52m)
Coarse Sand	5' (1.52m)	5' (1.52m)	6' (1.83m)	4' (1.22m)
Fine Gravel	5' (1.52m)	7' (2.13m)	10' (3.05m)	6' (1.83m)
Medium Gravel	5' (1.52m)	5' (1.52m)	6' (1.83m)	5' (1.52m)
Shredded Tires*	10-12' (3.0-3.6m)	N/A	N/A	N/A

*This data is from tests conducted by independent testing laboratories on a 6-inch depth of uncompressed shredded tire samples produced by four manufacturers. The tests reported critical heights, which varied from 10 feet to greater than 12 feet. It is recommended that persons seeking to install shredded tires as a protective surface request test data from the supplier showing the critical height of the material when it was tested in accordance with ASTM F1292.

It should be recognized that all injuries due to falls cannot be prevented no matter what surfacing material is used.

2. Fall Zones - A fall zone, covered with a protective surfacing material, is essential under and around equipment where a child might fall. This area should be free of other equipment and obstacles onto which a child might fall. Stationary climbing equipment and slides should have a fall zone extending a Minimum of 6' in all directions from the perimeter of the equipment.

Swings should have a fall zone extending a minimum of 6' from the outer edge of the support structure on each side. The fall zone in front and back of the swing should extend out a minimum distance of twice the height of the swing as measured from the ground to the top of the swing support structure.

LEVELING YOUR FORT DURING ASSEMBLY

- Complete the steps which will be the basic frame of the fort {i.e. four corner posts with base (sand box boards) and deck supports}
- Position in the most level area chosen for the playset, keeping in mind the location and size of the swing beam, ladder, slides, etc. that extend off the fort.
- Once the frame is in the final position, check for vertical and horizontal levelness to determine which side(s) will need to be dug into the ground to level the play set.
- With a shovel, score the ground around the outside edges of the sandbox boards on the 'high' side of the fort. This is the area that will be dug in. Make sure to score deep enough; the scored lines will be your digging template.
- Push the frame off and away from the scored area, far enough to dig and remove dirt to reach the appropriate depth.
- Dig a channel along the scored line(s) for the base of the fort (corner post and sandbox boards) to rest into. Dig the channel(s) to the same level depth. The bottom of the channel(s) should be level to each other so your frame doesn't teeter or rock because the channel(s) are uneven.
- Once you have removed enough grass and dirt, slide/push the frame into the channel(s). Place a level on the vertical and horizontal boards of the frame to determine if enough soil, or too much, was removed.
- Repeat this process until the basic frame is plumb and level and in its final position before completing the rest of the assembly.
- Measure to make sure fort is square.

Important: if you require a channel depth of more than 6", then we recommend you have your play set area professionally graded before completing assembly.

Example play area:

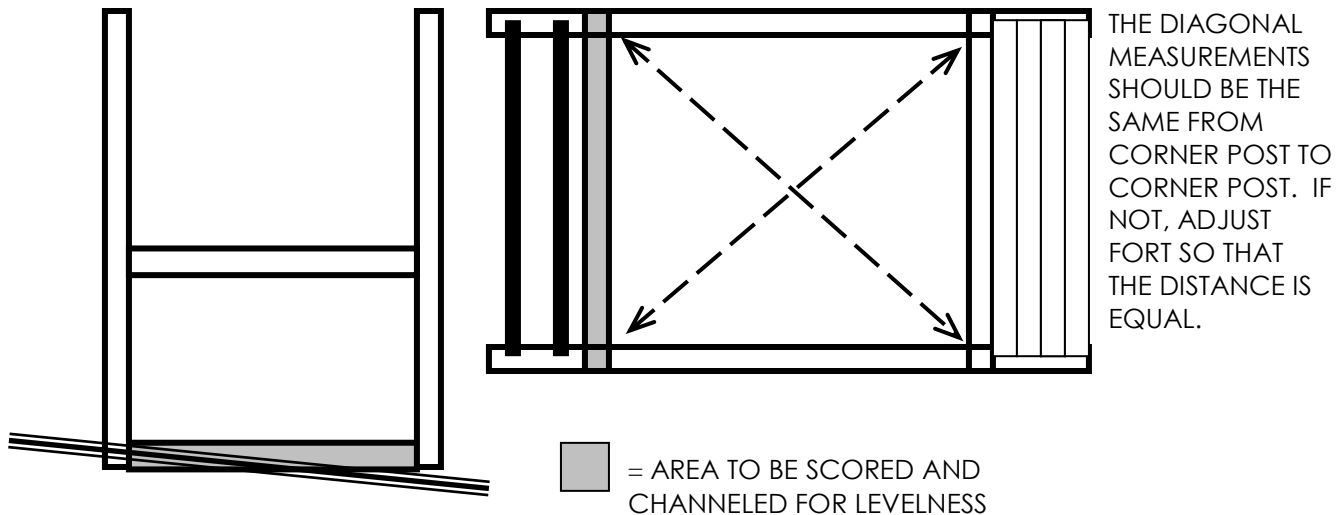

Monkey Bar Add On KIT CONTENTS

COMPONENTS

Description (Manual)	Qty	Check List
Monkey Bar Add On Assembly Manual	1	_____

**Description
(Monkey Bar Hardware)** *see following pages*

**Description
(Wood Components)** *see following pages*

REQUIRED TOOL LIST

Standard or Cordless Drill w/ Phillips Bit (#2 square bit provided)

1/8" Drill Bit

3/8" Drill Bit

1/2" Wrench, Socket, and Deep Well Socket

9/16" Wrench, Socket, and Deep Well Socket

Level

Tape Measure

Extension Cord (if using standard drill)

Hammer

Pencil

Locking Pliers

Shovel

Rubber Mallet

General Info To Review Before Installation

Helpful Installation Hints

- Depending on your experience, assembly of Gorilla playsets can take as little as 6 hours up to 24 hours, depending on size, after inventory of parts; therefore, we recommend you set aside a full two days for assembly.
- Identify all of the parts for your playset. Empty each box and lay out boards so you can see each part. Your instruction book will have detailed drawings that will make it easy for you to recognize individual parts. Keep all hardware and metal parts separate from wooden pieces.
- After everything is laid out, check carefully to ensure all parts are present. Make sure there are no broken boards.
- Find an area to sort your hardware. It is best to open the hardware on a solid surface so that you do not lose any pieces in the grass. This will save time and familiarize you with all the different pieces in the hardware bag.
- Important note: Wood has some natural defects such as knots, surface cracks, etc. We reject parts that are structurally defective. We use a high quality lumber in our structures; however, during shipping, boards may rub together, causing rough spots. You should inspect each part for splinters or rough spots and sand them smooth to prevent injury.
- After familiarizing yourself with all of the components, read all instructions thoroughly. Reading instructions after you have studied the parts will help you understand more clearly the installation process, and help to eliminate unnecessary mistakes.
- Pay close attention to the diameter and length of each bolt and screw.
- Never tighten hardware completely at first. It helps to have some adjustment for bolt alignment while you are attaching parts together. After everything is square, tighten each joint.
- After the main unit is assembled it is critical that the floor is **level** and **square**. If the main frame is not level, the walls and floor will be out of square.
- After you complete installation, make sure every bolt, screw, and nut is tight, and every board is secure. Wood will expand and contract with the seasons. Check all bolt connections and swing hangers seasonally.
- Place the set on level ground, not less than 6ft from any structure or obstruction such as a fence, garage, house, overhanging branches, laundry lines, or electrical wires.

This page is a list of definitions and explanations used throughout our instructions to aid you in the assembly of your play set.

Offset Holes- Throughout the installation procedures we will refer to parts with offset holes. This refers to the orientation of the holes on the board. An offset hole is one that is closer to one side than it is the other or in other words, it is not centered on the board. In the procedures you will be instructed to attach the boards with the holes offset up or with the holes offset down. This refers to which side of the board the hole/holes should be closer to. Offset holes up= hole/holes will be closer to the top of the board. Offset holes down= hole/holes will be closer to the bottom of the board. Note: some parts do not have offset holes, but instead the holes are on center. Therefore there will not be any reference to how to offset these parts.

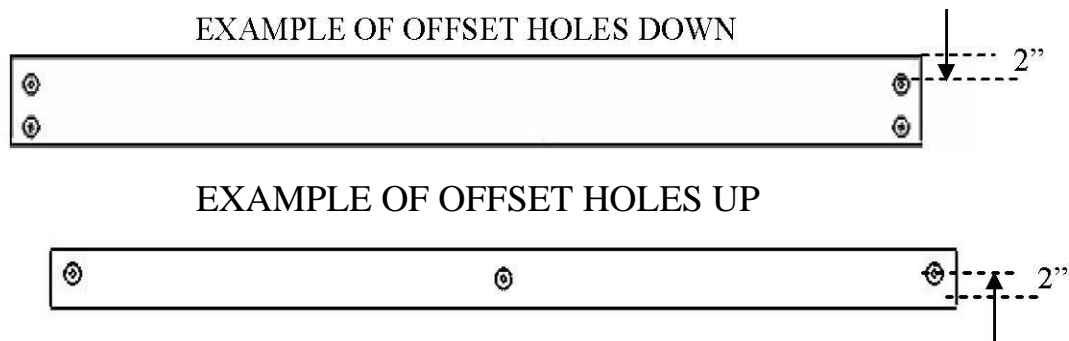

Counter-sunk holes- Many of the parts that will be used have counter-sunk holes. A counter-sunk hole is one that surrounds one side of a thru hole, but does not extend through the wood itself. When using a counter-sunk hole the bolt will be inserted through the thru hole and either the head of the bolt and washer or nut and washer will occupy the counter sunk hole.

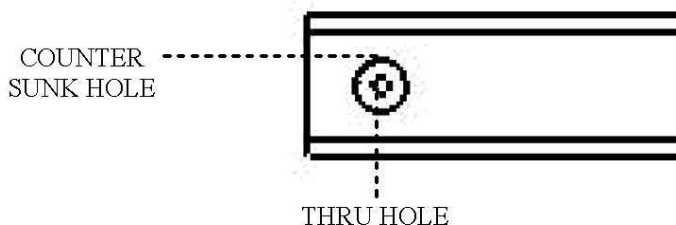

Lag Screws- Lag screws are used in the construction of our playsets to enhance the structural integrity of the unit. There will not be predrilled holes in the post for lag screw installation. Lag screws are self-tapping, though if you are using a manual socket wrench it may be necessary to tap the head of the lag screw with a hammer. You should also be sure to tighten the lags completely. Power tools such as an impact wrench or power drill should have enough torque to drive the lag screws without using a hammer, but make sure not to over tighten as this can cause the threads to "strip out" in the post.

Common installation practice
Installing T-nuts

When installing T-nuts into the wood, use a smooth faced hammer to set the face of the T-nut flush into the wood.

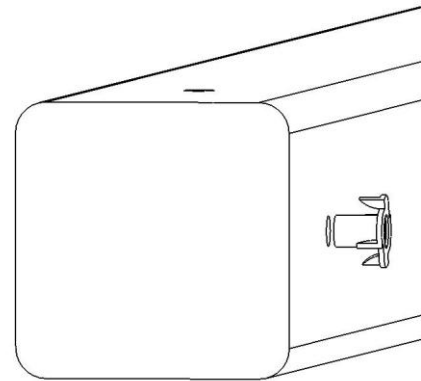
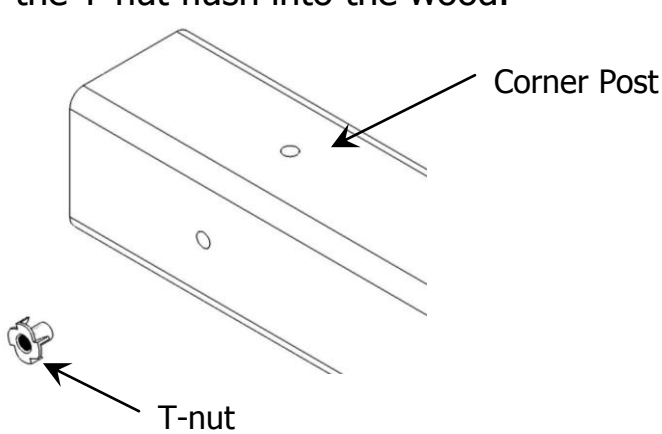

Insert the barrel of the T-nut into the predrilled hole. Using a smooth faced hammer, drive the T-nut until the face of the T-nut is flush to the wood.

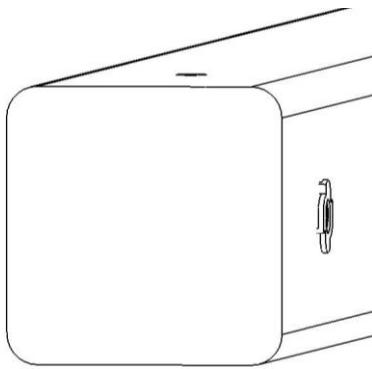

This picture shows the T-nut insert and installed flush to the wood.

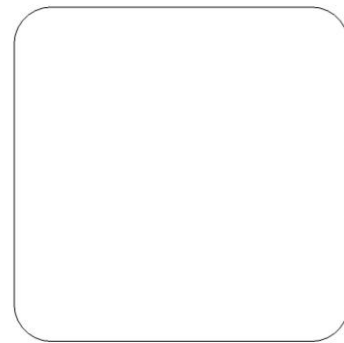

This picture shows an end view of the T-nut insert and installed flush to the wood.
WARNING: DO NOT EMBED THE TOP OF THE T-NUT INTO THE FACE OF THE WOOD

Cross Section end views, you are looking at an X-ray view of the post and T-nut. The barrel of the T-nut is in the corner post the line is the face of the wood.

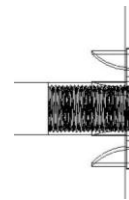

Flush
Correct

#10 X 2" SELF
DRILLING SCREW
QTY: 18



END OF SCREW
LOOKS SPLIT
SIMILAR TO A
DRILL BIT.

#8 X 2"
WOOD SCREW
QTY: 8



#14 x 1-1/4"
PAN HEAD SCREW
QTY: 4



5/16" TEE NUT
QTY: 8

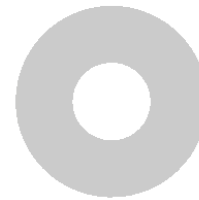

3/8" WASHER
QTY: 8



5/16" WASHER
QTY: 8



1/4" WASHER
QTY: 4



5/16" x 3-1/2"
HEX BOLT
QTY: 8

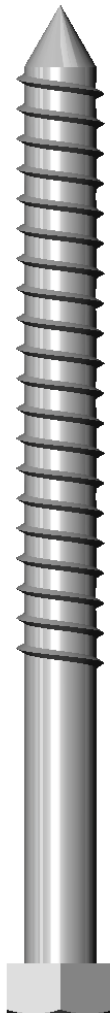





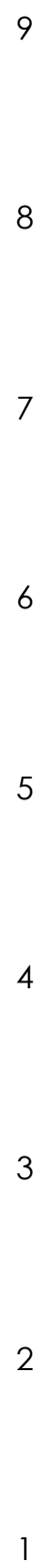

3/8" X 5"
HEX LAG SCREW
QTY: 8



#2 SQUARE
DRILL BIT
QTY: 1

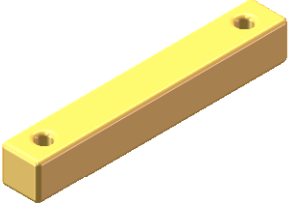

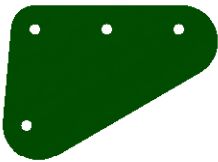
USE THE RULER TO THE RIGHT TO MEASURE YOUR BOLTS AND SCREWS. PICTURE VIEWS SHOWN ABOVE ARE 1:1 SCALE AND CAN BE USED TO MATCH BOLT AND SCREW SIZES.

PICTURE	DESCRIPTION	QTY.
	<p>4 x 4 x 70" MONKEY BAR RUNNER - LEFT</p> <p>4-4-7000-MBRL</p>	<p>1</p>
	<p>4 x 4 x 70" MONKEY BAR RUNNER - RIGHT</p> <p>4-4-7000-MBRR</p>	<p>1</p>
	<p>4 x 4 x 86.50" MONKEY BAR LADDER SIDE</p> <p>4-4-8650-MBL</p>	<p>2</p>
	<p>4 x 4 x 22.5" MONKEY BAR SUPPORT</p> <p>4-4-2225-MBS</p>	<p>2</p>
	<p>1-5/16" DIA. X 19.75" LONG" MONKEY BAR</p> <p>1975-MB</p>	<p>9</p>
	<p>8-5/8"W X 6-1/2"H MONKEY BAR PLATE</p> <p>11-1209</p>	<p>2</p>
	<p>SAFETY HANDLE</p>	<p>2</p>

PICTURE	DESCRIPTION	QTY.
NOT SHOWN	HARDWARE BOX INSTRUCTIONS	1 EA.

STEP 1: ASSEMBLING THE LADDER

1: SEE **FRONT SIDE** BELOW. START WITH THE 4 X 4 X 86-1/2" LADDER SIDES. WITH THE LARGE HOLES FACING YOU INSTALL A TEE NUT INTO THE TWO SMALL HOLES AT THE END OF EACH SIDE.

2: SEE **FRONT SIDE** BELOW. LOCATE FOUR 1-5/16" DIAMETER X 19.75" LONG CYLINDRICAL MONKEY BAR RUNGS. LAY ONE LADDER SIDE ON THE GROUND WITH THE LARGE HOLES FACING UP. INSERT A RUNG INTO EACH LARGE HOLE WITH THE WELD SEAM INSIDE THE RUNG FACING THE **END** OF THE LADDER SIDE. YOU MAY HAVE TO USE A RUBBER Mallet TO SEAT THE RUNG AGAINST THE BOTTOM OF EACH LARGE HOLE.

3: SEE **BACK SIDE** BELOW. MEASURE 5/8" FROM THE INSIDE EDGE OF THE LADDER SIDE AND MAKE A MARK CENTERED OVER THE TOP RUNG. MAKE SURE THE RUNG IS SEATED AGAINST THE BOTTOM OF HOLE. PREDRILL A 1/8" PILOT HOLE THROUGH THE WOOD, THEN THROUGH THE TOP SURFACE OF THE RUNG FACING YOU. NEXT, DRIVE A #10 X 2" L SELF TAPPING SCREW THROUGH THE WOOD INTO THE RUNG. REPEAT THIS STEP FOR EACH RUNG, PREDRILLING THEM ONE AT A TIME AND THEN INSTALLING A #10 X 2" L SELF TAPPING SCREW.

4: PLACE THE LADDER SIDE WITH THE RUNGS IN IT ON THE GROUND WITH THE RUNGS POINTING UPWARDS. LOCATE THE OTHER LADDER SIDE AND PLACE THE LARGE HOLES ONTO THE RUNG ENDS. IF NECESSARY USE A RUBBER Mallet TO SEAT THE RUNGS INTO THE BOTTOM OF EACH LARGE HOLE. PLACE THE LADDER DOWN FLAT ON THE GROUND WITH THE SCREWS FACING YOU. REPEAT STEP 3 TO ATTACH THE OTHER LADDER SIDE TO THE RUNGS WITH SELF TAPPING SCREWS.

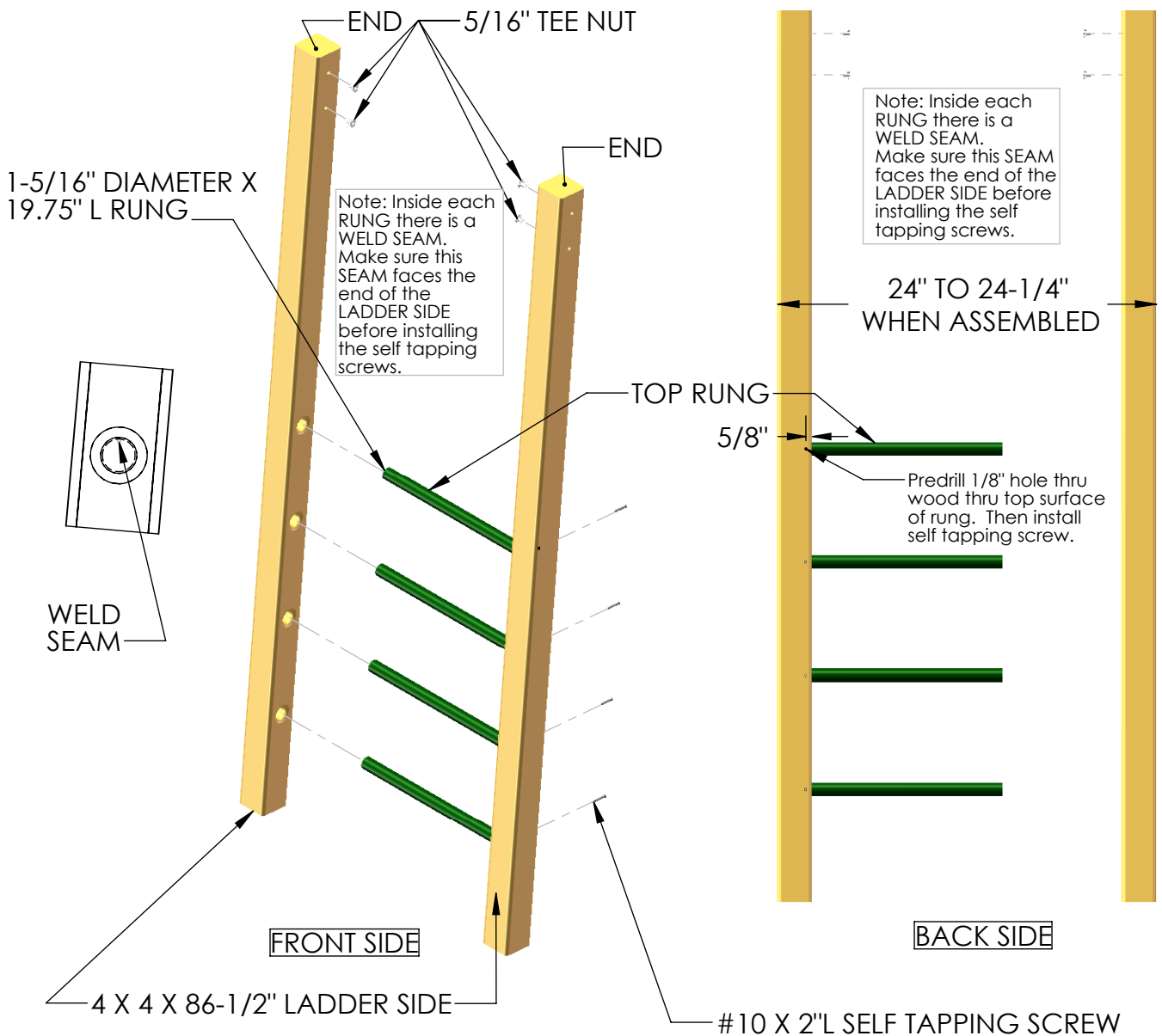

STEP 2: ASSEMBLING THE MONKEY BAR ASSEMBLY

1: PLEASE NOTE: THERE IS A LEFT AND RIGHT MONKEY BAR RUNNER. (See bottom left pictures below.)

2: START WITH THE 4 X 4 X 70" MONKEY BAR RUNNERS. WITH THE FIVE LARGE HOLES FACING YOU INSTALL A 5/16" TEE NUT INTO THE TWO SMALL HOLES AT THE ANGLED END OF EACH MONKEY BAR RUNNER.

3: SEE **TOP** BELOW. LOCATE FIVE 1-5/16" DIAMETER X 19.75" LONG CYLINDRICAL MONKEY BAR RUNGS. LAY THE **LEFT** MONKEY BAR RUNNER ON THE GROUND WITH THE LARGE HOLES FACING UP. INSERT A RUNG INTO EACH LARGE HOLE WITH THE WELD SEAM INSIDE THE RUNG FACING THE **END** OF THE RUNNER. YOU MAY HAVE TO USE A RUBBER Mallet TO SEAT THE RUNG AGAINST THE BOTTOM OF EACH LARGE HOLE. **DO NOT** ATTACH THE **RIGHT** MONKEY BAR RUNNER TO THE RUNGS YET.

4: SEE **BOTTOM** AT RIGHT BELOW. THE BOTTOM SIDE OF EACH MONKEY BAR RUNNER HAS ONLY ONE LARGE HOLE IN IT. MEASURE 5/8" FROM THE INSIDE EDGE OF THE MONKEY BAR RUNNER AND MAKE A MARK CENTERED OVER THE RUNG. MAKE SURE THE RUNG IS SEATED AGAINST THE BOTTOM OF HOLE. PREDRILL A 1/8" PILOT HOLE THROUGH THE WOOD, THEN THROUGH THE TOP SURFACE OF THE RUNG FACING YOU. NEXT, DRIVE A #10 X 2"L SELF TAPPING SCREW THROUGH THE WOOD INTO THE RUNG. REPEAT THIS STEP FOR EACH RUNG, PREDRILLING THEM ONE AT A TIME AND THEN INSTALLING A #10 X 2"L SELF TAPPING SCREW.

5: PLACE THE **LEFT** MONKEY BAR RUNNER WITH THE RUNGS ATTACHED TO IT ON THE GROUND WITH THE RUNGS POINTING UPWARDS. LOCATE THE **RIGHT** MONKEY BAR RUNNER AND PLACE THE FIVE LARGE HOLES ONTO THE RUNG ENDS. IF NECESSARY USE A RUBBER Mallet TO SEAT THE RUNGS INTO THE BOTTOM OF EACH LARGE HOLE. PLACE THE MONKEY BAR RUNNER ASSEMBLY DOWN FLAT ON THE GROUND WITH THE SCREWS FACING YOU. REPEAT STEP 4.

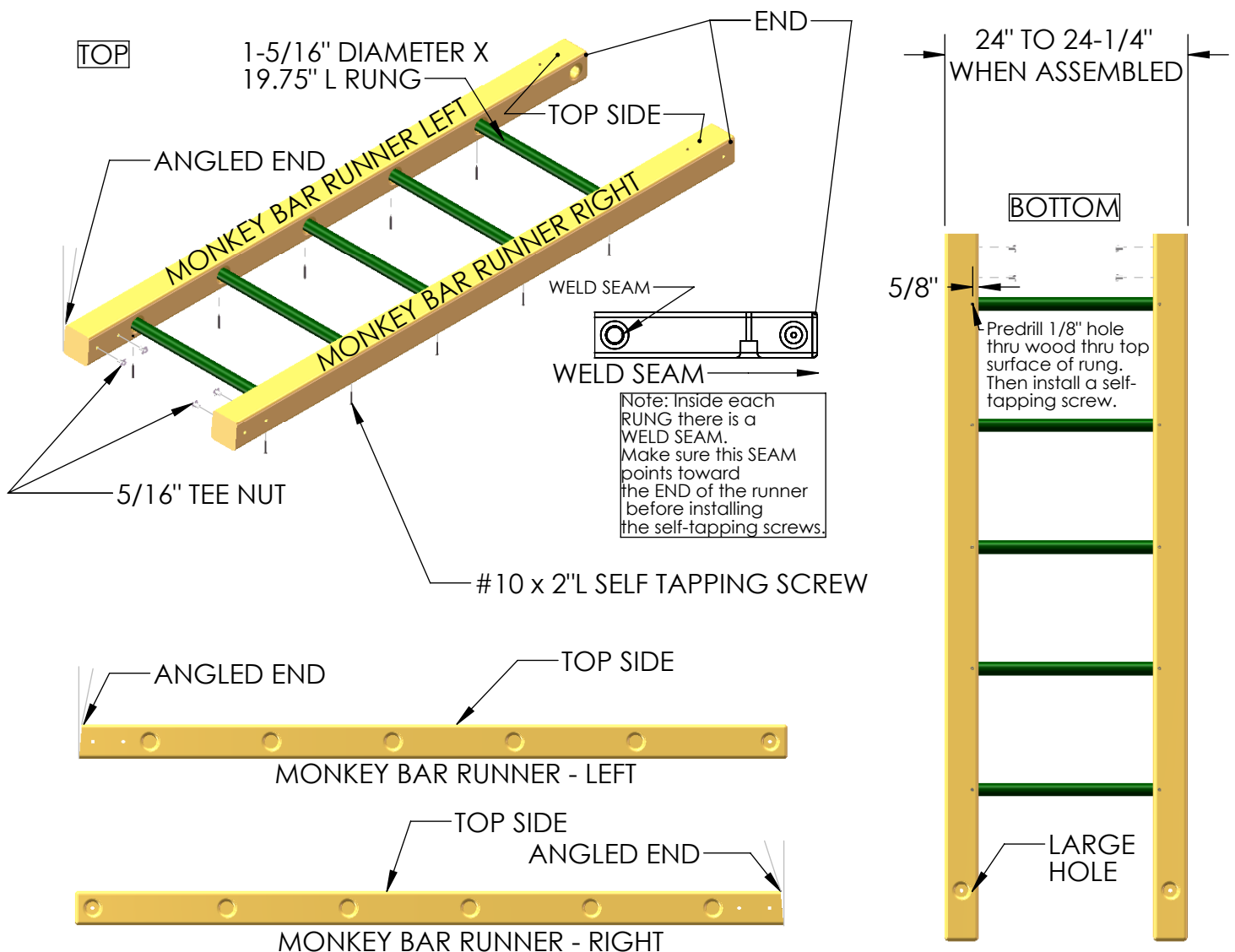

STEP 3: ATTACHING THE LADDER TO THE MONKEY BAR ASSEMBLY

1: LOCATE TWO 8-5/8" W X 6-1/2"H MONKEY BAR PLATES, EIGHT 5/16" X 3-1/2"L HEX BOLTS AND EIGHT 5/16" FLAT WASHERS. **LOOSELY** ATTACH THE LADDER ASSEMBLY TO THE MONKEY BAR ASSEMBLY WITH THE MONKEY BAR PLATES. USE 5/16" X 3-1/2"L HEX BOLTS WITH 5/16" FLAT WASHERS TO ATTACH THE MONKEY BAR PLATES TO THE TEE NUTS PREVIOUSLY INSTALLED..

2: ONCE ALL THE HEX BOLTS ARE STARTED IN THE TEE NUTS TIGHTEN THEM DOWN.

NOTE: THE SELF TAPPING SCREWS INSTALLED IN STEPS 1 & 2 SHOULD BE FACING BACK SIDE OF THE LADDER ASSEMBLY AND THE UNDER SIDE OF THE MONKEY BAR ASSEMBLY.

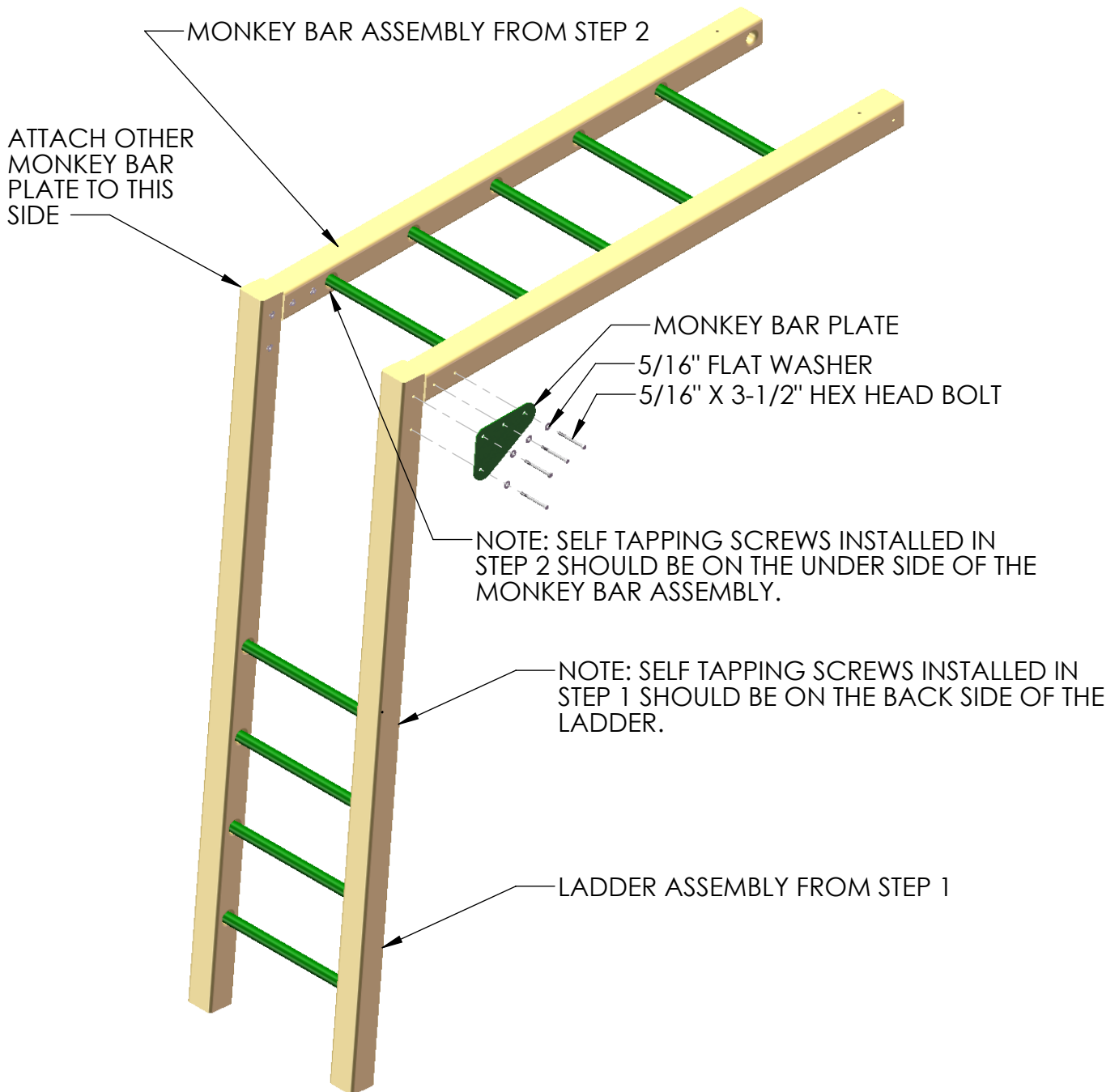

STEP 4: ATTACHING THE MONKEY BAR UNIT TO THE PLAYSET

1: IF YOUR PLAYSET IS ALREADY ASSEMBLED AND YOU PURCHASED THE MONKEY BAR ADD ON KIT THEN YOU MUST REMOVE THE THREE 5/4 X 4 X 28-1/2" PANEL SLATS IN THE AREA SHOWN IN THE TOP RIGHT PICTURE BELOW. SAVE THE PANEL SLATS FOR INSTALLATION IN STEP 6.

2: POSITION THE MONKEY BAR UNIT AS SHOWN BELOW NEXT TO THE WAVE SLIDE. A SECOND PERSON WILL BE NEEDED FOR THIS STEP.

3: MAKE THE END SURFACE OF THE MONKEY BAR RUNNERS FLUSH WITH THE CORNER POST AND CENTER POST. MAKE THE TOP SURFACE OF THE MONKEY BAR RUNNERS FLUSH WITH THE BOTTOM SURFACE OF THE SIDE RAIL. HAVE AN ASSISTANT HOLD EACH MONKEY BAR RUNNER IN POSITION WHILE YOU DRIVE IN TWO 3/8" X 5" HEX LAG SCREWS WITH TWO 3/8" WASHERS THROUGH THE HOLES IN THE MONKEY BAR RUNNER END.

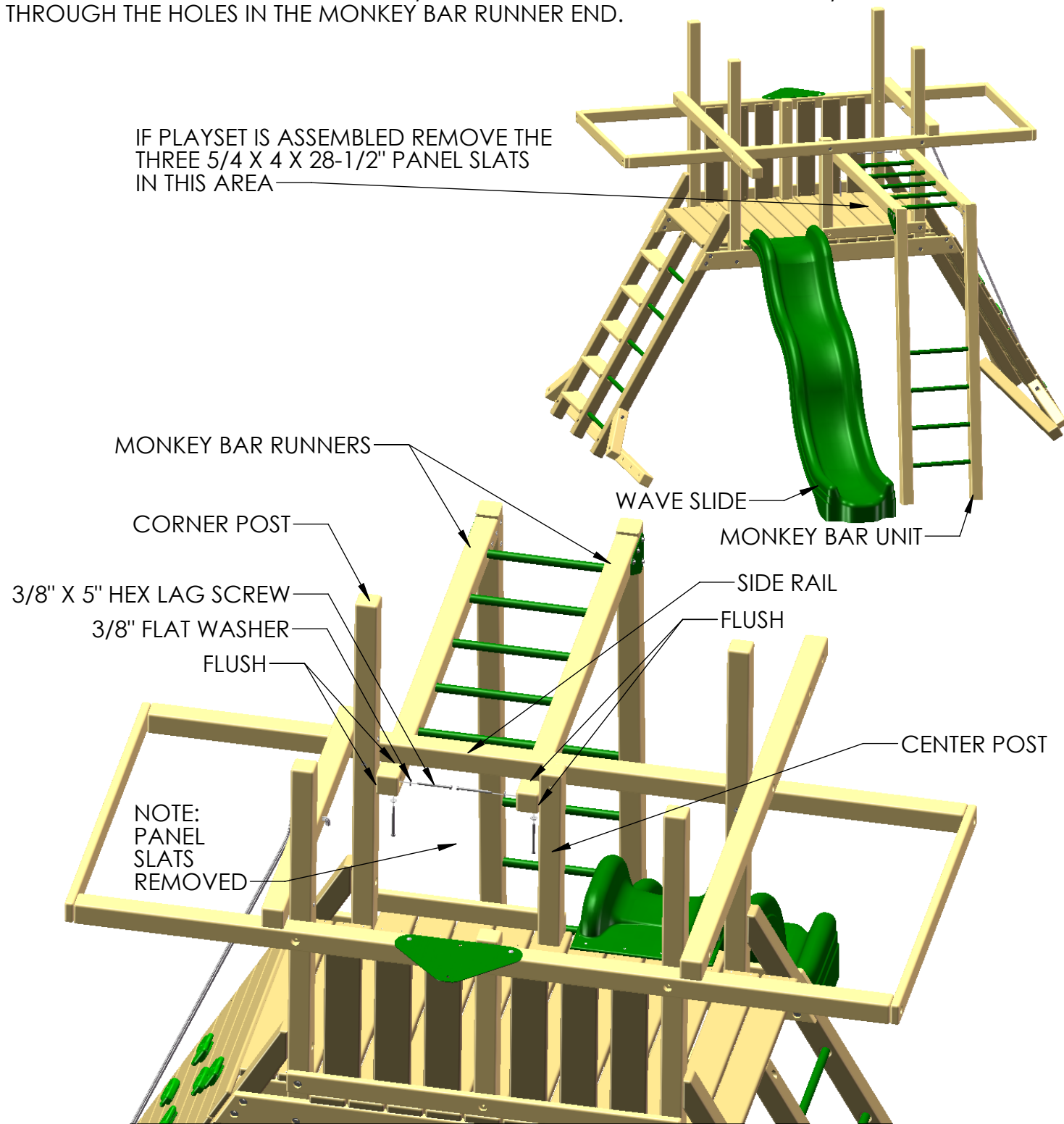

STEP 5: ATTACHING THE MONKEY BAR SUPPORTS

1: START WITH THE TWO 4 X 4 X 22-1/2"L MONKEY BAR SUPPORTS.

2: PLACE A MONKEY BAR SUPPORT AGAINST THE CORNER POST WITH THE LARGE HOLES FACING THE THE CENTER POST. THE TOP END SURFACE OF THE MONKEY BAR SUPPORT SHOULD BE FLUSH WITH THE BOTTOM SURFACE OF THE MONKEY BAR RUNNER. THE SIDE SURFACE OF THE MONKEY BAR SUPPORT SHOULD BE FLUSH WITH THE SIDE SURFACE OF THE CORNER POST.

3: ATTACH THE MONKEY BAR SUPPORT TO THE CORNER POST WITH TWO 3/8" X 5" HEX LAG SCREWS AND TWO 3/8" FLAT WASHERS.

4: PLACE A MONKEY BAR SUPPORT AGAINST THE CENTER POST WITH THE LARGE HOLES FACING THE THE CORNER POST. THE TOP END SURFACE OF THE MONKEY BAR SUPPORT SHOULD BE FLUSH WITH THE BOTTOM SURFACE OF THE MONKEY BAR RUNNER. THE SIDE SURFACE OF THE MONKEY BAR SUPPORT SHOULD BE FLUSH WITH THE SIDE SURFACE OF THE CENTER POST.

5: ATTACH THE MONKEY BAR SUPPORT TO THE CENTER POST WITH TWO 3/8" X 5" HEX LAG SCREWS AND TWO 3/8" FLAT WASHERS.

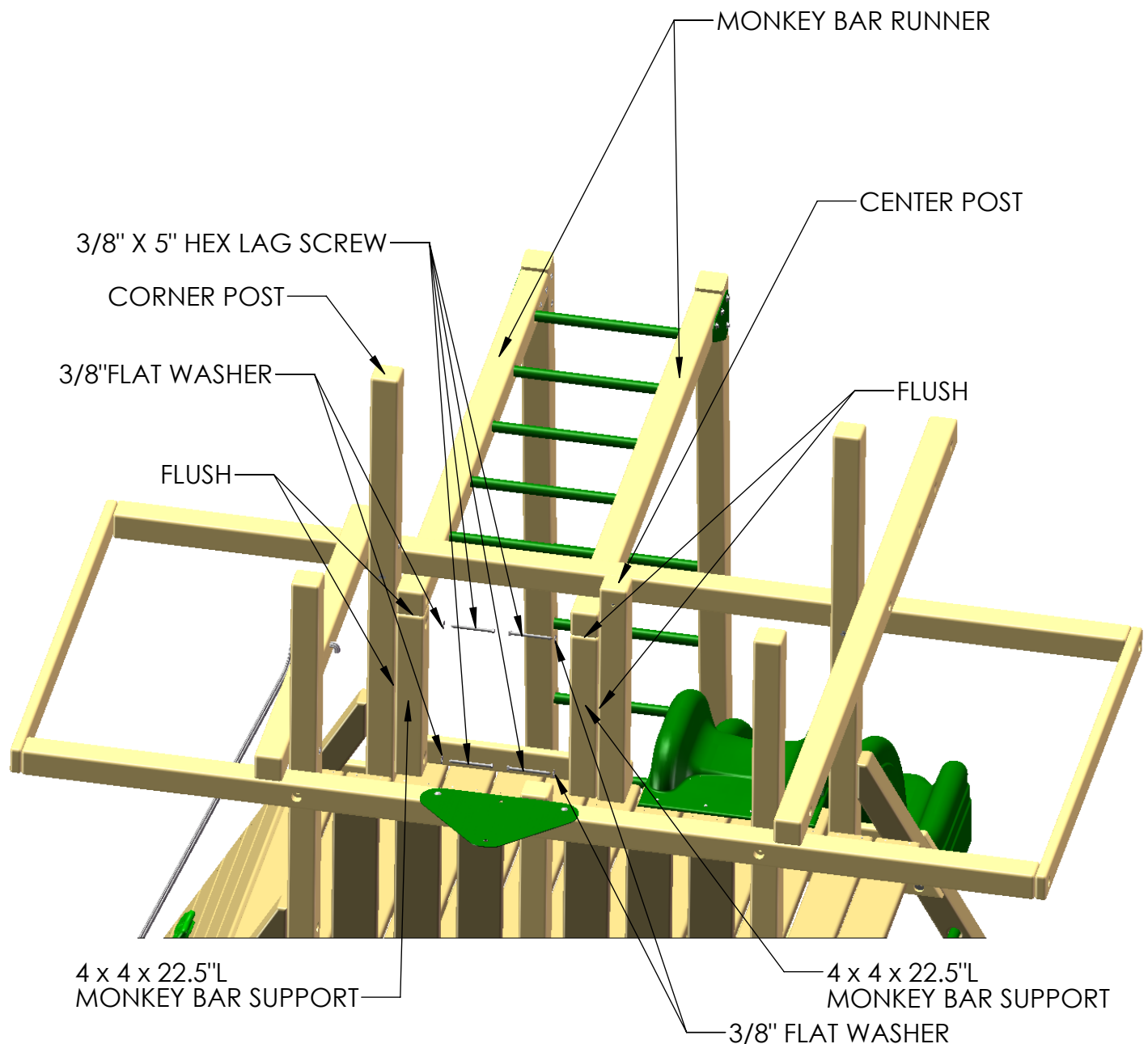

STEP 6: REATTACHING THE PANEL SLATS

1: LOCATE TWO OF THE 5/4 X 4 X 28-1/2" PANEL SLATS REMOVED IN STEP 4.

2: ALIGN THE TOP END SURFACE OF EACH PANEL SLAT FLUSH WITH THE TOP SURFACE OF THE SIDE RAIL. SPACE THE PANEL SLATS EQUALLY IN THE OPENING.

3: ATTACH EACH PANEL SLAT TO THE SIDE RAIL AND BOTTOM PANEL BOARD USING FOUR #8 X 2" WOOD SCREWS.

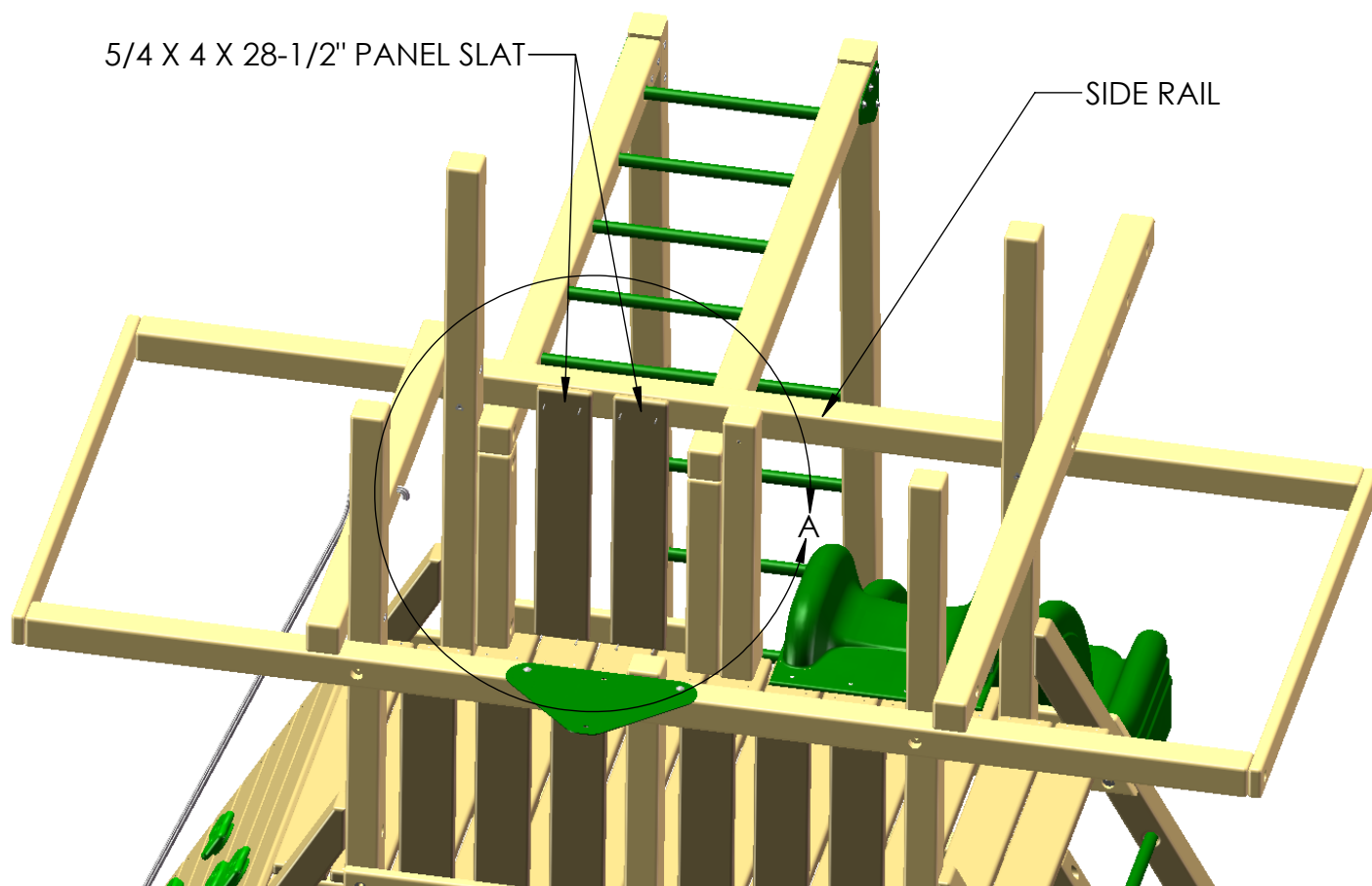
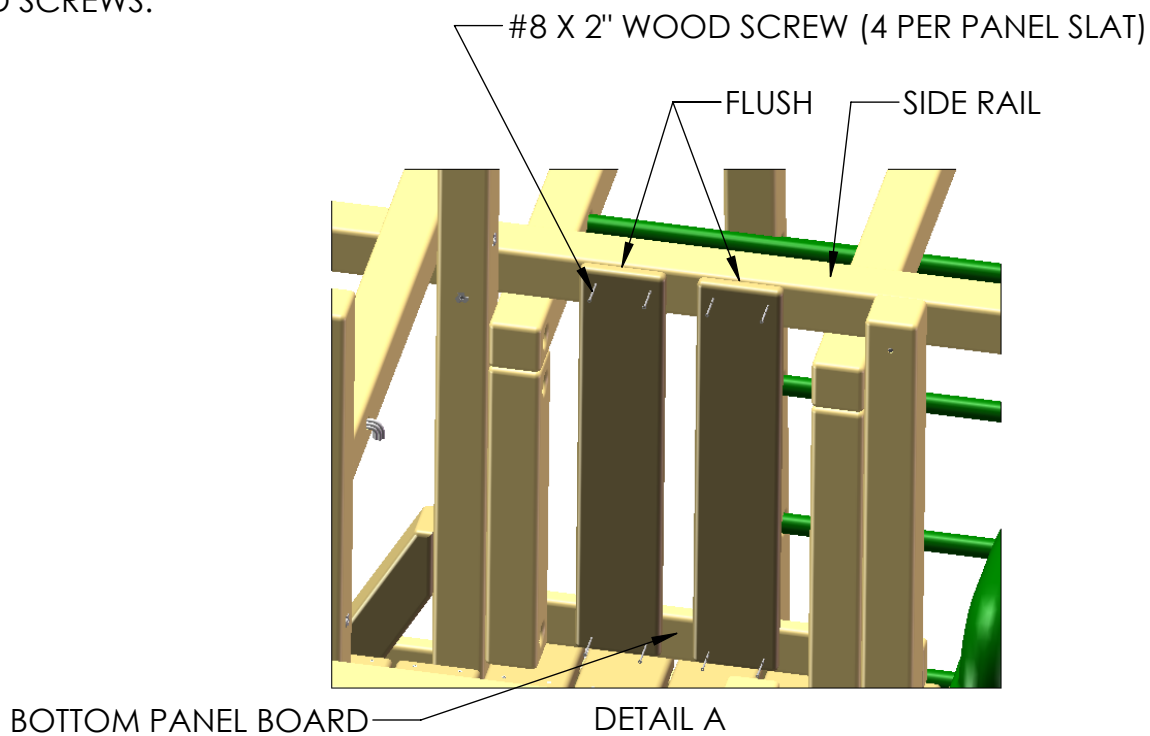

STEP 7: ATTACHING THE SAFETY HANDLES

1: LOCATE THE TWO GREEN SAFETY HANDLES, FOUR #14 X 1-1/4" PAN HEAD SCREWS AND FOUR 1/4" FLAT WASHERS.

2: ATTACH EACH SAFETY HANDLE TO THE LADDER SIDE WITH TWO #14 X 1-1/4" PAN HEAD SCREWS AND TWO 1/4" FLAT WASHERS PER HANDLE. ADJUST THE HANDLES UP AND DOWN VERTICALLY TO SUIT YOUR CHILD'S REACH.

