



Blue Ridge Ranger II ASSEMBLY MANUAL

Copyright © 2008 PlayNation Play Systems, Inc.
All Rights Reserved

PlayNation Play Systems, Inc. • 190 Etowah Industrial Court • Canton, GA 30114 • (800) 661-7295

04/JUNE/2008



STOP...PLEASE READ!!

**IF YOU HAVE MISSING OR DAMAGED PARTS OR
NEED ASSISTANCE ASSEMBLING, PLEASE
CALL PlayNation MANUFACTURING DIRECT.**

(800) 661-7295

FACTORY HOURS – MON.–FRI., 8AM-5PM EST

DO NOT RETURN THIS PRODUCT TO THE RETAILER OR CONTACT THE
RETAILER DIRECT. THE RETAILER DOES NOT STOCK COMPONENTS.

PLEASE RETAIN THESE INSTRUCTIONS FOR FUTURE REFERENCE. KEEP THEM IN A
SAFE PLACE WHERE YOU CAN REFER TO THEM AS NEEDED.

CONTACT INFO:

**PlayNation Play Systems, Inc.
190 Etowah Industrial Court
Canton, GA 30114
Tel. (770) 704-9300
Fax. (678) 880-3300**

**PLEASE READ OWNER'S MANUAL CAREFULLY BEFORE
STARTING ASSEMBLY!**



Blue Ridge Ranger II

TABLE OF CONTENTS

Warranty and Safety Guidelines.....	4-10
Kit Contents and Tool List.....	11-29
Framing the play set.....	steps 1-8
Constructing deck and panel boards.....	steps 9-13
Constructing ramp and securing to fort.....	steps 14-17
Installing center posts.....	step 18
Installing tarp boards.....	steps 19-20
Installing panel slats.....	step 21
Installing and attaching rock wall.....	steps 22-26
Installing sandbox seats then adding picnic table and benches.....	steps 27-33
Mounting slide.....	step 34
Installing tarp.....	step 35
Swing beam assembly.....	steps 36-44
Installing rope ladder and safety handles.....	steps 45-47
Installing optional ground stakes.....	step 48

**PLEASE READ OWNER'S MANUAL CAREFULLY BEFORE
STARTING ASSEMBLY!**

Thank you for choosing **PlayNation Play Systems** for your new backyard playground!

We've included everything you need, except tools, to build your very own professional looking playset. When complete, your new playset should far exceed the quality of playset kits from other build-your-own companies. Our engineers and design team have over 30 years of playground experience. What we've developed is a playset that doesn't compromise quality for simplicity. Yet you'll appreciate how quick and easy construction really is! Our playset kits are designed for children ages 3 to 11. **PlayNation Play Systems** believes every child should have a playset and with our kits they can! You can rest assured your new playset is safe, durable and designed to hold up to the elements. As parents ourselves, we know how important the security and well being of our children is, and this shows in all of our products.

Each playset features our step-by-step 3D illustrated manual, patented powder coated swing beam bracket, heavy-duty swing belts with chains, slide(s), accessories, plus all the required hardware and pre-milled lumber.

Quality Lumber

At **PlayNation Play Systems**, we use only the finest, hand selected lumber available. Whether you choose a playset made from our Premium Preserved Pine, our Beautiful California Redwood or our Western Red Cedar, you can be assured that our lumber is strong, durable, and conforms to the national standards for use in children's play equipment. It's this quality that allows us to offer a 10 year warranty on the lumber used in our play sets.

Premium Preserved Pine

Our Premium Preserved Pine is double kiln dried. We utilize this process to minimize shrinkage, warping, and cupping. Because our pine has been "pre-shrunk", the hardware used to assemble your playset will hold tight, stay tight, and won't loosen or weaken. Our preserved pine is clean, odorless, non-staining, and non-irritating to humans, animals, or plants. PlayNation's Preserved Pine uses one of the only exterior wood preservation systems that is EPA approved. Our pine lumber is preserved with a preservative system containing copper and quaternary compounds to protect against termite attack and fungal decay. Our Premium Preserved Pine can withstand harsh weather conditions and is effective for decades, Making PlayNation Play Systems the best choice in pine lumber built swing sets.

California Redwood and Western Red Cedar*

Our Beautiful California Redwood and Western Red Cedar playsets are a natural alternative to preserved lumber. California Redwood naturally resists decay caused by the environment or by insect infestation while Western Red Cedar is a preferred wood for purposes where an attractive appearance and resistance to weather is important. All California Redwood and Western Red Cedar PlayNation Playsets receive a factory stain and sealant process. To maintain this aesthetic appeal, it is recommended that you seal your redwood and cedar play set once per year.

*Playnation reserves the right to substitute Western Red Cedar with other species of similar characteristics due to market availability.

Limited Manufacturers Warranty

PlayNation Play Systems, Inc. warrants this product to be free from defects in workmanship and materials, under normal use and conditions, for a period of 10 years for structural wood components and one year for all other components (i.e., hardware, plastics, tarps, rope ladder, etc.). Cosmetic defects that do not affect the structural integrity of the product, or natural defects of wood such as warping, checking or any other physical properties of wood that do not present a safety hazard, are not covered by this warranty.

PlayNation Play Systems, Inc. will repair, or, at its discretion, replace any part within the stated warranty period that is defective in workmanship or materials. This decision is subject to verification of the defect upon delivery of the defective part to **PlayNation Play Systems, Inc.** at 190 Etowah Industrial Court, Canton, Georgia 30114. Any part(s) returned to **PlayNation Play Systems, Inc.** must include proof and date of purchase.

This warranty is valid only if the product is used for the purpose for which it was designed and installed at a residential, single-family dwelling. This warranty is void if the product is put to commercial or institutional use. This warranty does not cover (a) products which have been damaged by negligence, natural disasters, or accident by improper use, or which have been modified or repaired by unauthorized persons, (b) the cost of labor, or (c) the cost of shipping the product, any part, or any replacement product or part.

This warranty is valid only in the United States of America, is non-transferable and does not extend to the owners of the product subsequent to the original purchaser. **PlayNation Play Systems, Inc.** disclaims all other representations and warranties of any kind, express, implied, statutory or otherwise, including the implied warranties of merchantability and fitness for a particular purpose. **PlayNation Play Systems, Inc.** will not be liable for any incidental or consequential damages. Some states do not allow limitations on implied warranties or exclusion of incidental or consequential damages, so these restrictions may not be applicable to you. This warranty gives you specific legal rights. You may also have other rights that vary from state to state.

IMPORTANT SAFETY GUIDELINES

This product is intended for residential use only and not intended for use in any public setting. A safety surface such as mulch or recycled tire should be used under the play set to prevent injury from falls. Also a 6 foot safety zone should be used around the entire playset.

As with any home project, good judgment and respect for power tools will greatly reduce the risk of injury. **PlayNation Play Systems, Inc.** recommends you follow all tool manufacturers' safety guidelines. Always wear eye protection and safety gloves to prevent injury. In several phases of construction two people may be required for lifting and securing of lumber. While playset is being constructed, please keep children off the equipment until the project is complete. Bolts and screw heads should be checked regularly for tightness. The ground ladder, rope ladder, slide, swings and other areas where children spend a majority of their playtime should be checked more frequently.

PlayNation Play Systems, Inc. shall not be liable for incidental, indirect or consequential damages or injuries that result from the building and/or playing on our playsets. Adult supervision is recommended anytime a playset is being used.

WEIGHT LIMITS FOR PLAYNATION PLAYSETS

- FORT PLATFORMS: 800 LBS. TOTAL WEIGHT
- SWING BELTS: 175 LBS.
- GLIDER SWINGS: 70 LBS. PER CHILD
- TRAPEZE: 125 LBS.
- FULL BUCKET SWING: 50 LBS.
- TODDLER BUCKET SWING: 50 LBS.
- INFANT SWING: 35 LBS.
- TIRE SWING: 125 LBS. TOTAL WEIGHT
- ROPE LADDER: 75 LBS.
- ROCK WALL: 150 LBS.
- ALL SLIDES: 125 LBS.

PlayNation Play Systems, Inc. recommends that the weight limits for all components must not be exceeded. Failure to adhere to these and other safety guidelines could result in damage to the playset and injury to the users.

Safety and Maintenance Tips for Your New Play Set:

NOTE: Your children's safety is our #1 concern. Observing the following statements and warnings reduces the likelihood of serious or fatal injury. Please review these safety rules regularly with your children.

- This playset is designed for the use of 4 occupants who have a combined weight **not exceeding** 800 pounds on the elevated floor, 3 occupants who have a combined weight of 525 pounds on the swing area, for a total Unit capacity of 5 occupants who have a combined weight of 1325. (this weight is not including the picnic table area)
- On-site adult supervision is **required**.
- Teach children **not** to walk close to, in front of, behind, or between moving swings or other moving playground equipment.
- Teach children to sit in and **never** stand on swings
- Teach children **not** to twist the chains and ropes and not to loop them over the swing beam, since this may reduce the strength of the chain or rope.
- Teach children **not** to jump from swings or other playground equipment in motion.
- Teach children to **not push** empty seats. The seat may hit them and cause serious injury.
- Teach and teach children to sit in the center of the swings with their full weight on the seats.
- Teach children **not** to use the equipment in a manner other than intended.
- Teach children to **always** go down slides feet first. Never slide headfirst.
- Teach children to **look** before they slide to make sure no one is at the bottom.
- Teach children to **never** run up a slide, as this increases their chances of falling.
- The parents should have the children **dress appropriately** with well-fitting shoes. Loose clothing such as scarves and ponchos should not be worn. Always take off, tie up or tuck in cords and drawstrings on children's clothing. These things can get caught on playground equipment and strangle a child.
- Teach children **not** to climb when the equipment is wet.
- Teach children to **never** jump from a fort deck. They should always use the ladder, ramp or slide.
- Teach children to **never** crawl or walk across the top of monkey bars.
- Teach children to **never** crawl on top of a fort roof.
- Verify that any suspended climbing ropes, chain, or cable are secured at both ends and that they cannot be looped back on it.
- Teach children **not** to attach items to the playground equipment that are not specifically designed for use with the equipment, such as, but not limited to, jump ropes, clothesline, pet leashes, cables and chain as they may cause a strangulation hazard.
- Teach children to **never** use Monkey Bar when swings or glider are in use.
- Teach children to **never** wrap their legs around swing chain.
- Teach children to **never** slide down the swing chain.

WARNING: Children must NOT use this playset until unit has been completely assembled and inspected by an adult to insure set has been properly installed and anchored.

Safety and Maintenance Tips for Your New Play Set: (continued)

Playgrounds should be inspected on a regular basis. If any of the following conditions are noted, they should be removed, corrected or repaired immediately to prevent injuries.

- Hardware that is loose, worn or that has protrusions or projections
- Exposed equipment footings
- Scattered debris, litter, rocks, or tree roots
- Splinters, large cracks, and decayed wood components.
- Deterioration and corrosion on structural components, which connect to the ground
- Missing or damaged equipment components, such as handholds, guardrails, swing seats.
- Check all nuts and bolts twice monthly during the usage season and tighten as required. (But not so tight that you crack the wood) We recommend you check the swing beam and hardware every two weeks due to wood expansion and contraction. It is particularly important that this procedure be followed at the beginning of each season.
- Remove plastic swing seats and take indoors or do not use when the temperature drops below 32°F.
- Oil all metallic moving parts monthly during the usage period.
- Check all coverings for bolts and sharp edges twice monthly during usage season to be certain they are in place. Replace when necessary. It is especially important to do this at the beginning of each new season.
- Check swing seats, ropes, cables and chains monthly during usage season for evidence of deterioration. Replacement should be made of any swing seat that has developed cracks in the plastic seats or has exposed metal in the edges of the swing seat. If there are already exposed metal inserts on the edge of the seat, immediately remove the seats and chains to prevent serious injury. Ropes, cables and chains should be removed and replaced if excessive wear is found. Contact PlayNation Play Systems for replacement parts.
- For rusted areas on metallic members such as monkey bars, hand supports brackets, etc.; sand and repaint, using a non lead-based paint meeting the requirements of Title 16 CRF Part 1303.
- Inspect wood parts monthly. The grain of the wood sometimes will lift in the dry season causing splinters to appear. Light sanding may be necessary to maintain a safe playing environment. If you are treating your playset with stain regularly, it will help prevent severe checking/splitting and other weather damage.
- Once or twice a year, depending on your climate conditions, you must apply some type of protection (sealant) to the wood of your unit. Prior to the application of sealant, lightly sand any "rough" spots on your set. Please note this is a requirement of your warranty.
- Creating and maintaining the playset on a level location is very important. As your children play, your playset will slowly dig its way into the soil, and it is very important that it settles evenly. Make sure the play set is level and true once each year or at the beginning of each play season.
- Rake the surface periodically to prevent compaction and maintain appropriate depths.

Disposal Instructions: When the playset use is no longer desired, it should be disassembled and disposed of in such way that no unreasonable hazards will exist at the time the unit is discarded.

Play Set Surfacing Recommendations:

Below are some of the recommendations that the U.S. Consumer Product Safety Commission (CPSC) offers from its *Handbook for Public Playground Safety*. The guide can be downloaded in full at www.cpsc.gov/cpsc/pub/pubs/325.pdf

1. Protective Surfacing - Since almost 60% of all injuries are caused by falls to the ground, protective surfacing under and around all playground equipment is the most critical safety factor on playgrounds.

Certain manufactured synthetic surfaces also are acceptable; however, test data on shock absorbing performance should be requested from the manufacturer.

Asphalt and concrete are unacceptable. They do not have any shock absorbing properties. Similarly, grass and turf should not be used. Their ability to absorb shock during a fall can be reduced considerably through wear and environmental conditions.

Certain loose-fill surfacing materials are acceptable. Surfacing materials are acceptable, such as the types and depths shown in the table.

Material	Uncompressed Depth			Compressed Depth to 9" (228mm)
	6" (152mm)	9" (228mm)	12" (304mm)	
Wood Chips	7' (2.13m)	10' (3.05m)	11' (3.35m)	10' (3.05m)
Double-Shredded bark mulch	6' (1.83m)	10' (3.05m)	11' (3.35m)	7' (2.13m)
Engineered Wood Fibers	6' (1.83m)	7' (2.13m)	>12' (3.66m)	6' (1.83m)
Fine Sand	5' (1.52m)	5' (1.52m)	9' (2.74m)	5' (1.52m)
Coarse Sand	5' (1.52m)	5' (1.52m)	6' (1.83m)	4' (1.22m)
Fine Gravel	5' (1.52m)	7' (2.13m)	10' (3.05m)	6' (1.83m)
Medium Gravel	5' (1.52m)	5' (1.52m)	6' (1.83m)	5' (1.52m)
Shredded Tires*	10-12' (3.0-3.6m)	N/A	N/A	N/A

*This data is from tests conducted by independent testing laboratories on a 6-inch depth of uncompressed shredded tire samples produced by four manufacturers. The tests reported critical heights, which varied from 10 feet to greater than 12 feet. It is recommended that persons seeking to install shredded tires as a protective surface request test data from the supplier showing the critical height of the material when it was tested in accordance with ASTM F1292.

It should be recognized that all injuries due to falls cannot be prevented no matter what surfacing material is used.

2. Fall Zones - A fall zone, covered with a protective surfacing material, is essential under and around equipment where a child might fall. This area should be free of other equipment and obstacles onto which a child might fall. Stationary climbing equipment and slides should have a fall zone extending a Minimum of 6' in all directions from the perimeter of the equipment.

Swings should have a fall zone extending a minimum of 6' from the outer edge of the support structure on each side. The fall zone in front and back of the swing should extend out a minimum distance of twice the height of the swing as measured from the ground to the top of the swing support structure.

LEVELING YOUR FORT DURING ASSEMBLY

- Complete the steps which will be the basic frame of the fort {i.e. four center posts with base (sand box boards) and deck supports}
- Position in the most level area chosen for the playset, keeping in mind the location and size of the swing beam, ladder, slides, etc. that extend off the fort.
- Once the frame is in the final position, check for vertical and horizontal levelness to determine which side(s) will need to be dug into the ground to level the play set.
- With a shovel, score the ground around the outside edges of the sandbox boards on the 'high' side of the fort. This is the area that will be dug in. Make sure to score deep enough; the scored lines will be your digging template.
- Push the frame off and away from the scored area, far enough to dig and remove dirt to reach the appropriate depth.
- Dig a channel along the scored line(s) for the base of the fort (corner post and sandbox boards) to rest into. Dig the channel(s) to the same level depth. The bottom of the channel(s) should be level to each other so your frame doesn't teeter or rock because the channel(s) are uneven.
- Once you have removed enough grass and dirt, slide/push the frame into the channel(s). Place a level on the vertical and horizontal boards of the frame to determine if enough soil, or too much, was removed.
- Repeat this process until the basic frame is plumb and level and in its final position before completing the rest of the assembly.

Important: if you require a channel depth of more than 6", then we recommend you have your play set area professionally graded before completing assembly.

Example play area:

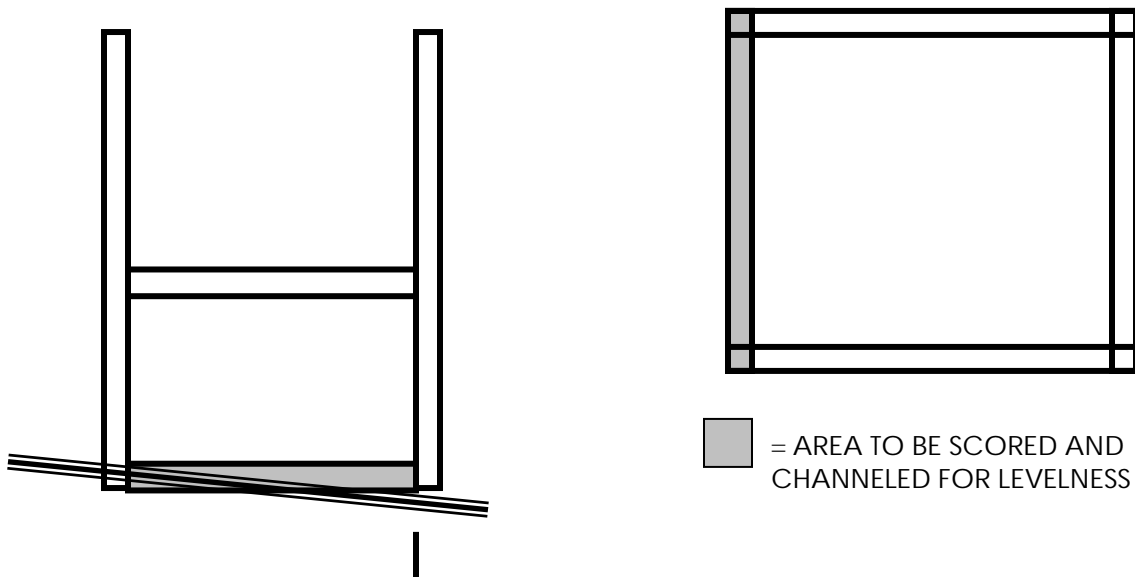

Blue Ridge Ranger II KIT CONTENTS

COMPONENTS

Description <i>(Swings, Slides, Accessories)</i>	Qty	Check List
Swingbelts w/ Chains	2	_____
10' Wave Slide	1	_____
Ranger II Assembly Manual	1	_____
Trapeze Swing	1	_____
Safety Handles	2	_____
Climbing Rocks	10	_____

Description
(Fort Hardware) *see following pages*

Description
(Swing Beam Hardware) *see following pages*

Description
(Wood Components) *see following pages*

REQUIRED TOOL LIST

- Standard or Cordless Drill w/ Phillips Bit (#2 square bit provided)
- 1/8" Drill Bit
- 3/8" Drill Bit
- 1/2" Wrench or Socket
- 9/16" Wrench or Socket
- Level
- Tape Measure
- Extension Cord (if using standard drill)
- Hammer
- Pencil
- Vice Grips
- Shovel

Please familiarize yourself with the manual, parts/components and general construction process of your new playset before getting started.

SITE PLAN:

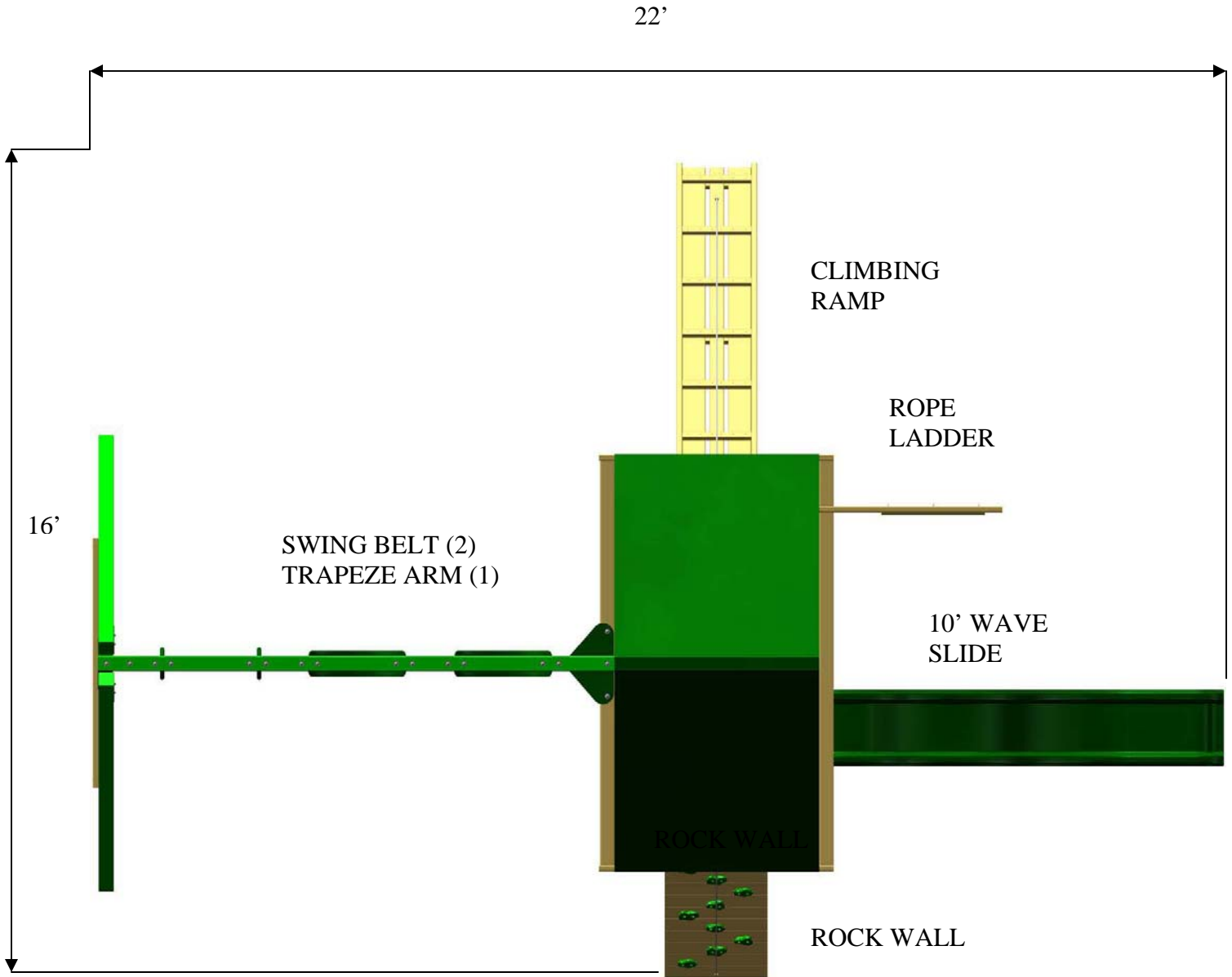

Playset height: 11'

Approximate assembly time:

8-10 Hours

{ 6 foot unobstructed safety perimeter around playset recommended }

Helpful Installation Hints

- Depending on your experience, assembly of PlayNation playsets can take as little as 6 hours up to 24 hours, depending on size, after inventory of parts. Therefore, we recommend you set aside a full two days for assembly.
- Identify all of the parts for your playset. Empty each box and lay out boards so you can see each part. Your instruction book will have detailed drawings that will make it easy for you to recognize individual parts. Keep all hardware and metal parts separate from wooden pieces.
- After everything is laid out, check carefully to ensure all parts are present. Make sure there are no broken boards.
- Find an area to sort your hardware. It is best to open the hardware on a solid surface so that you do not lose any pieces in the grass. This will save time and familiarize you with all the different pieces in the hardware bag.
- Important note: Wood has some natural defects such as knots, surface cracks, etc... We reject parts that are structurally defective. We use a high quality lumber in our structures; however, you should inspect each part for splinters or rough spots and sand them smooth to prevent injury.
- After familiarizing yourself with all of the components, read all the way through the instructions completely. Reading instructions after you have studied the parts will help you understand more clearly the installation process, and help to eliminate unnecessary mistakes.
- Pay close attention to the diameter and length of each bolt and screw.
- Never tighten hardware completely at first. It helps to have some adjustment for bolt alignment while you are attaching parts together. After everything is square, tighten each joint.
- After the main unit is assembled it is critical that the floor is level and square. If the main frame is not level, the walls and floor will be out of square.
- After you complete installation, make sure every bolt, screw, and nut is tight, and every board is secure. Wood will expand and contract with the seasons. Check all bolt connections and swing hangers every two weeks.
- Place the set on level ground, not less than 6ft from any structure or obstruction such as a fence, garage, house, overhanging branches, laundry lines, or electrical wires.

READ! VERY IMPORTANT!

If you are missing parts or have questions regarding the installation of our quality product PLEASE call us directly at the factory **(1-800-661-7295)**. Our trained staff will be happy to assist you.

**Customer service hours:
Monday thru Friday 8AM – 5PM EST**

General Info To Review Before Installation

This page is a list of definitions and explanations used throughout our instructions to aid you in the assembly of your playset.

Offset Holes- Throughout the installation procedures we will refer to parts with offset holes. This refers to the orientation of the holes on the board. An offset hole is one that is closer to one side than it is the other or in other words, it is not centered on the board. In the procedures you will be instructed to attach the boards with the holes offset up or with the holes offset down. This refers to which side of the board the hole/holes should be closer to. Offset holes up= hole/holes will be closer to the top of the board. Offset holes down= hole/holes will be closer to the bottom of the board. Note: some parts do not have offset holes, but instead the holes are on center. Therefore there will not be any reference to how to offset these parts.

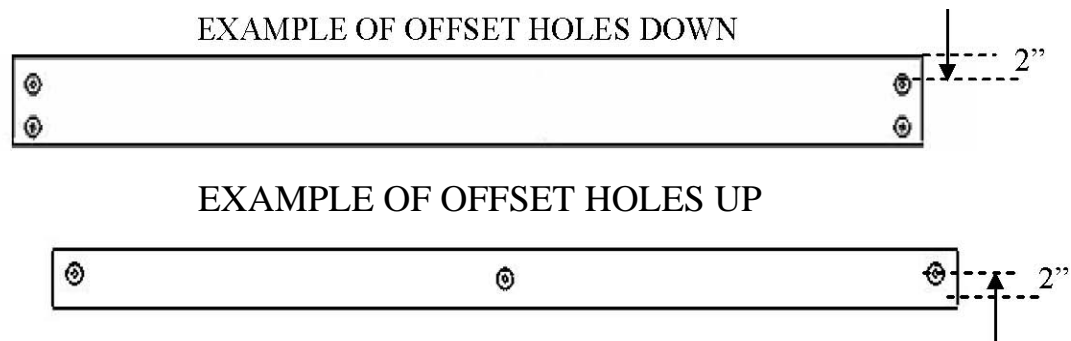

Counter-sunk holes- Many of the parts that will be used have counter-sunk holes. A counter-sunk hole is one that surrounds one side of a thru hole, but does not extend through the wood it's self. When using a counter-sunk hole the bolt will be inserted through the thru hole and either the head of the bolt and washer or nut and washer will occupy the counter sunk hole.

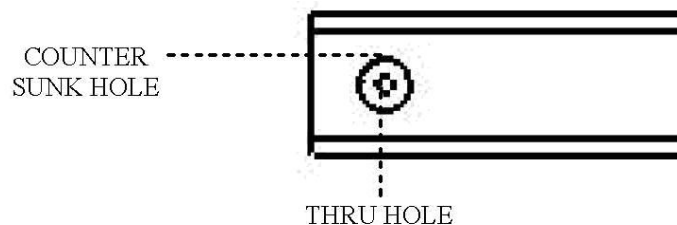

Lag Bolts- Lag bolts are used in the construction of our playsets to enhance the structural integrity of the unit. There will not be predrilled holes in the post for lag bolt installation. Lag bolts are self-tapping, though if you are using a manual socket wrench it may be necessary to tap the head of the lag bolt with a hammer to actuate. You should also be sure to tighten the lags completely. Power tools such as an impact wrench or power drill should have enough torque to drive the lag bolts without using a hammer, but make sure not to over tighten as this can cause the bolt threads to "strip out" in the post.

Common installation practice
Installing T-nuts

When installing T-nuts into the wood, use a smooth faced hammer to set the face of the T-nut flush into the wood.

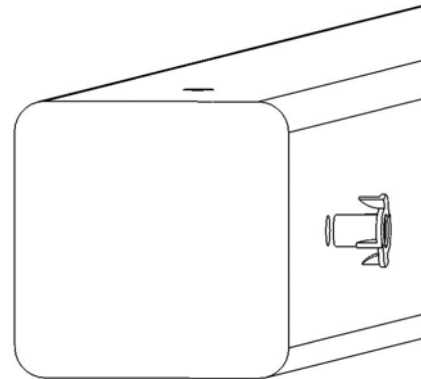
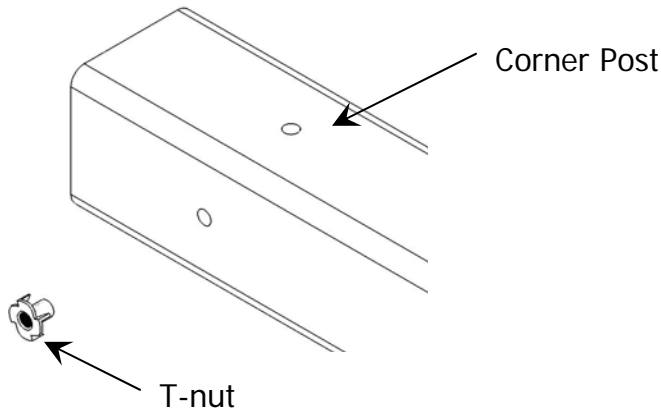

Insert the barrel of the T-nut into the predrilled hole. Using a smooth faced hammer, drive the T-nut until the face of the T-nut is flush to the wood.

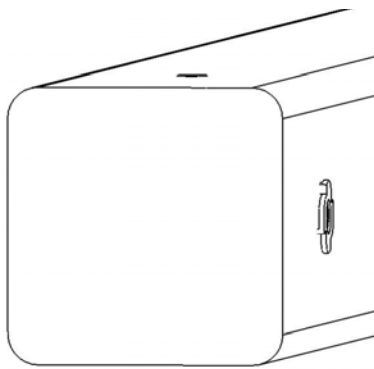

This picture shows the T-nut insert and installed flush to the wood.

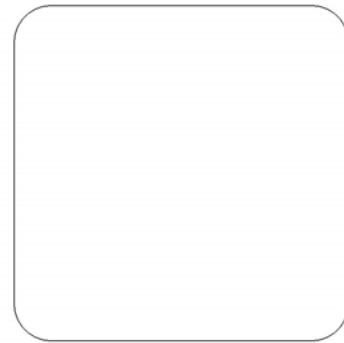

This picture shows an end view of the T-nut insert and installed flush to the wood.
WARNING: DO NOT EMBED THE TOP OF THE T-NUT INTO THE FACE OF THE WOOD

Cross Section end views, you are looking at an X-ray view of the post and T-nut. The barrel of the T-nut is in the corner post the line is the face of the wood.

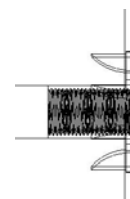

Flush
Correct



#14 X 1-1/4"
PAN HEAD SCREW
QTY: 20



#14 X 1"
PAN HEAD SCREW
QTY: 8



#8 X 1-1/4"
WOOD SCREW
QTY: 2



#8 X 2"
WOOD SCREW
QTY: 170



#8 X 2-1/2"
WOOD SCREW
QTY: 184



5/16 X 4-1/2"
HEX BOLT
QTY: 20



5/16 X 1-1/2"
HEX BOLT
QTY: 8



5/16" TEE NUT
QTY: 28



3/8" LOCK NUT
QTY: 21



1/2" WASHER
QTY: 21



3/8" WASHER
QTY: 66



1/4" WASHER
QTY: 8



5/16" WASHER
QTY: 28



USE THE RULER TO THE RIGHT TO MEASURE YOUR BOLTS AND SCREWS. PICTURE VIEWS SHOWN ABOVE ARE 1:1 SCALE AND CAN BE USED TO MATCH BOLT AND SCREW SIZES.

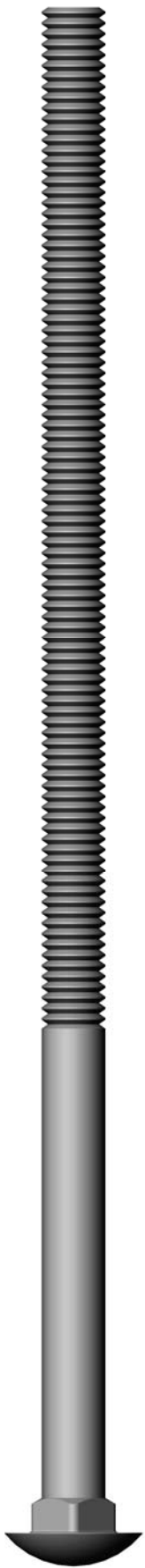

3/8 x 9"
CARIAGE BOLT
QTY: 1



3/8 x 6-1/2"
CARIAGE BOLT
QTY: 18



3/8 x 3-1/2"
CARIAGE BOLT
QTY: 2

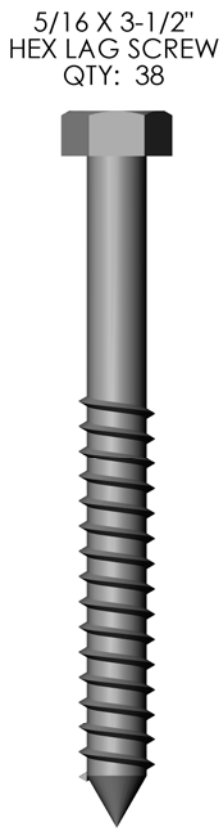

5/16 X 3-1/2"
HEX LAG SCREW
QTY: 38



5/16 X 4"
EYEBOLT LAG
QTY: 3

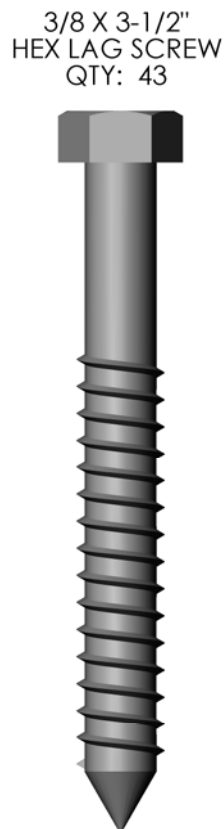

3/8 X 3-1/2"
HEX LAG SCREW
QTY: 43



#8 SQUARE
DRILL BIT
QTY: 1



GREEN PLASTIC
BOLT CAP
QTY: 21

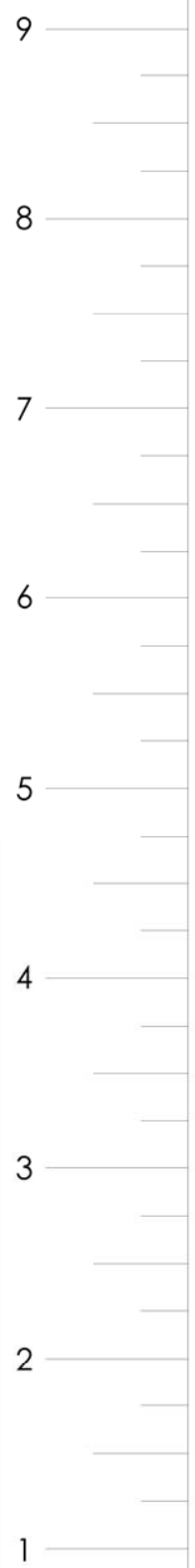

USE THE RULER TO THE RIGHT TO MEASURE YOUR BOLTS AND SCREWS. PICTURE VIEWS SHOWN ABOVE ARE 1:1 SCALE AND CAN BE USED TO MATCH BOLT AND SCREW SIZES.

BOX 1	PICTURE	DESCRIPTION	QTY.
		PLASTIC COATED 4 X 4 X 96" FRONT CORNER POST	4
		PLASTIC COATED 4 X 4 X 96" SWING LEG	2
		2 X 4 X 66" LADDER SIDE	2
		2 X 4 X 47 $\frac{1}{2}$ " END TOP PANEL BOARD	1
		2 X 4 X 21" PICNIC TABLE SUPPORT	2
		2 X 4 X 15 $\frac{1}{2}$ " PICNIC TABLE FRAME BOARD	1
		2 X 4 X 17" LADDER STEP	5

BOX 1	PICTURE	DESCRIPTION	QTY.
		2 X 4 X 12" END BOTTOM PANEL BOARD	4

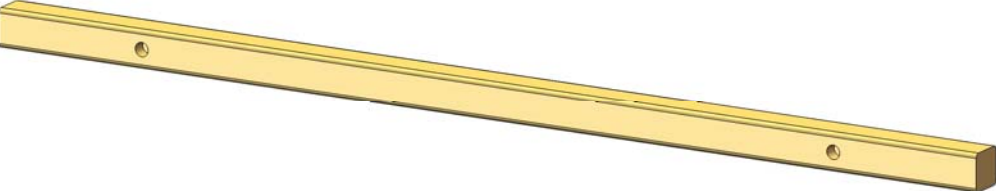
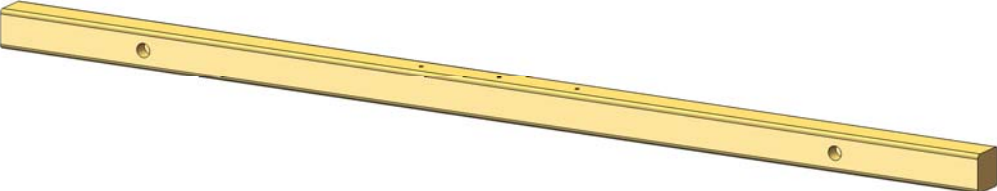
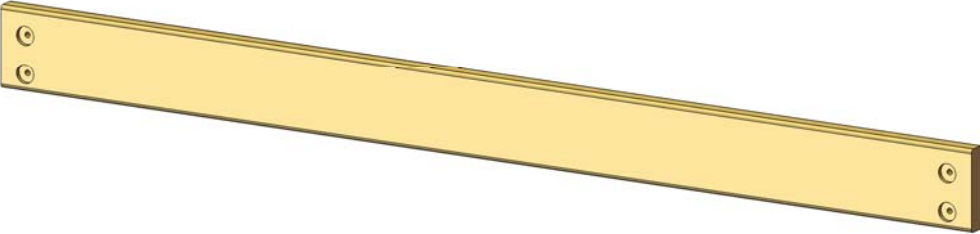
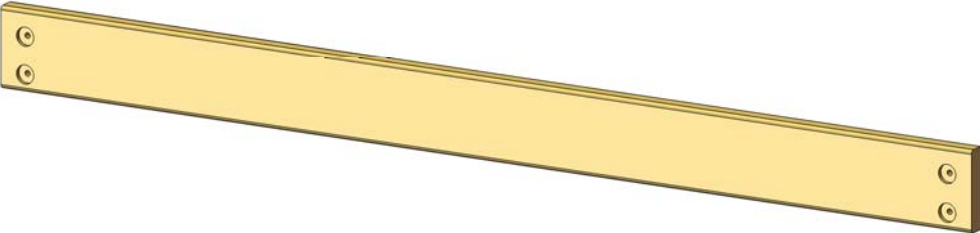
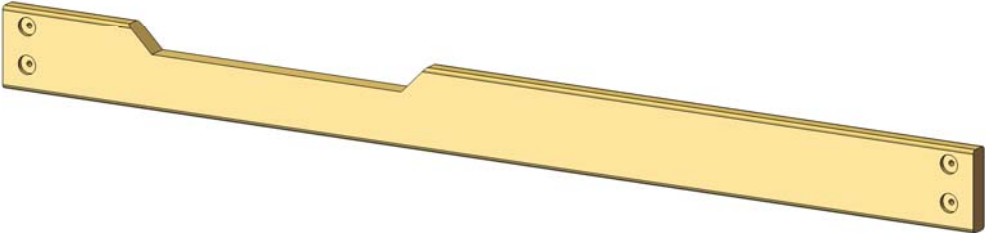
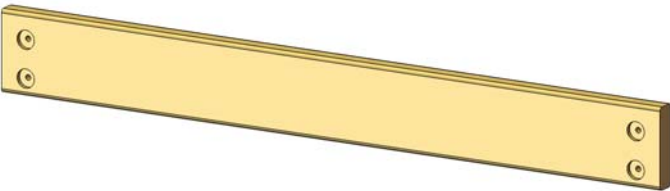
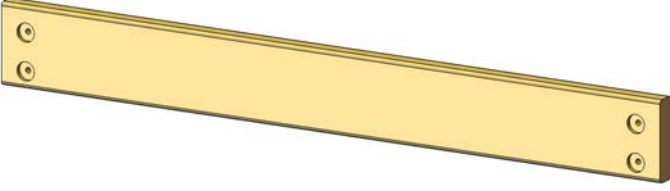
BOX 2	PICTURE	DESCRIPTION	QTY.
		4 X 4 X 94" TOP RAIL	1
		4 X 4 X 94" SWINGBEAM SIDE RAIL	1
		2 X 4 X 70" SANDBOX BOARD	2
		2 X 6 X 70" BOTTOM PANEL BOARD	1
		2 X 6 X 70" FRONT FACE BOARD	1
		2 X 6 X 47 $\frac{1}{2}$ " END BOTTOM PANEL BOARD	2
		2 X 6 X 47 $\frac{1}{2}$ " SANDBOX BOARD	1

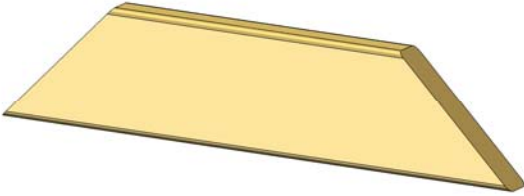
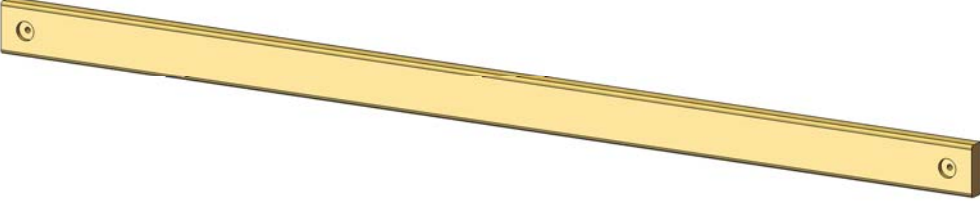
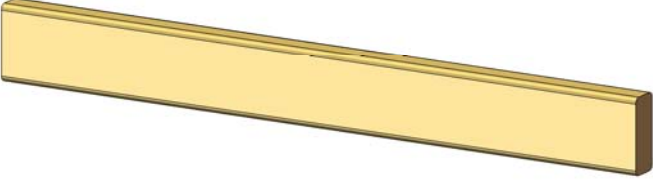
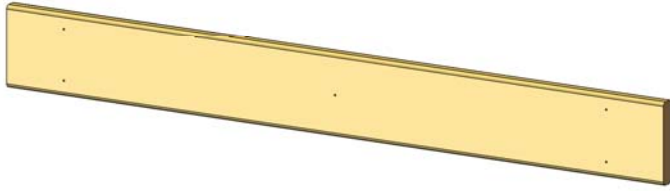
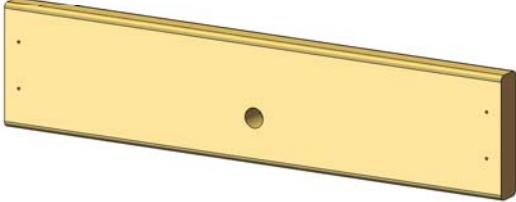
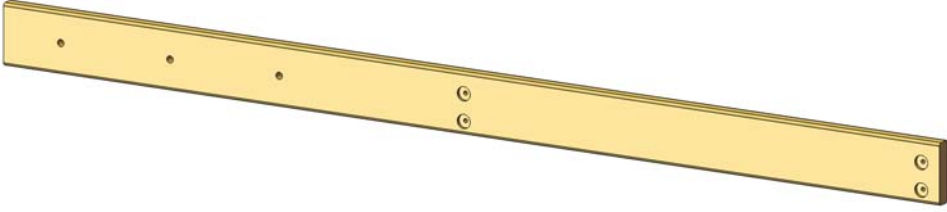
BOX 2	PICTURE	DESCRIPTION	QTY.
		2 X 6 X 24 $\frac{1}{2}$ " CORNER SEATS	2
		2 X 4 X 70" DECK SUPPORT	2
		2 X 4 X 30 $\frac{1}{2}$ " PICNIC TABLE FRAME	2
		$\frac{5}{4}$ X 6 X 47 $\frac{3}{8}$ " DECK BOARD	8
		$\frac{5}{4}$ X 6 X 23 $\frac{7}{8}$ " BOTTOM ROCK WALL BOARD	1
		2 X 6 X 89 $\frac{1}{2}$ " ROPE LADDER RUNNER	1

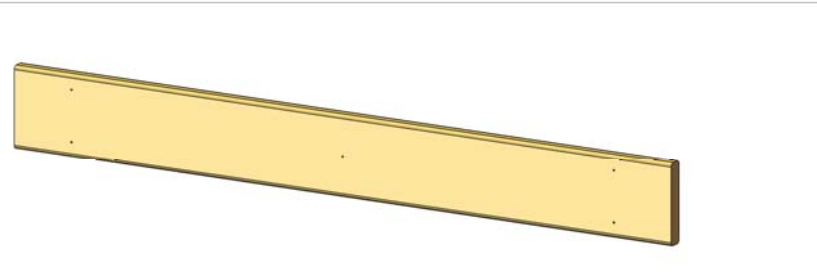
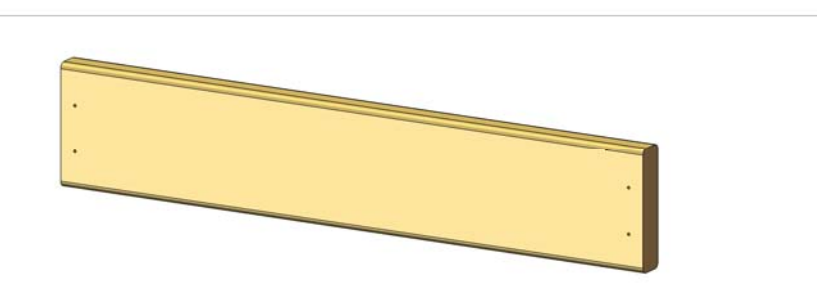
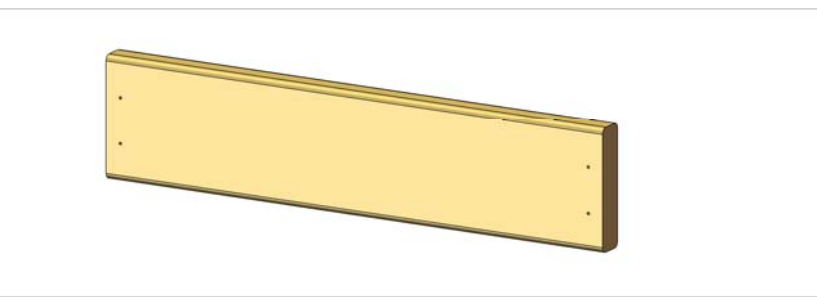
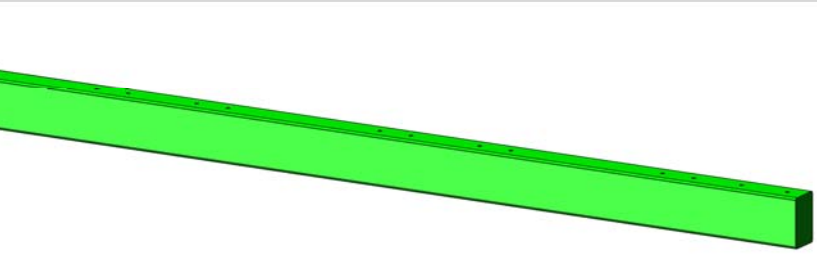
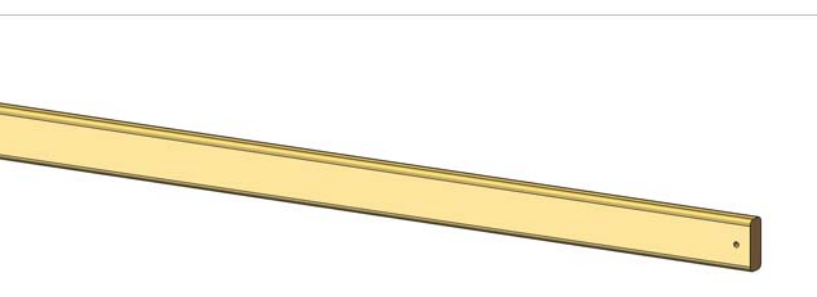
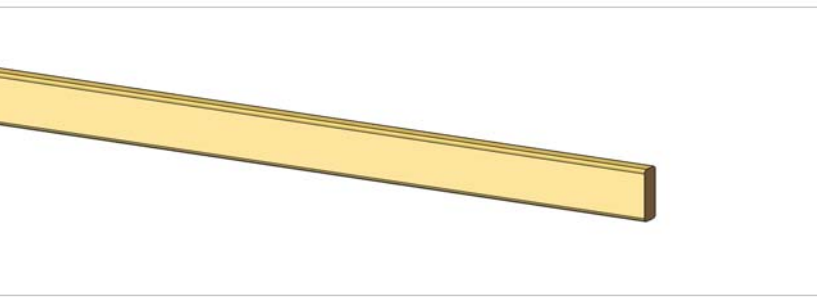
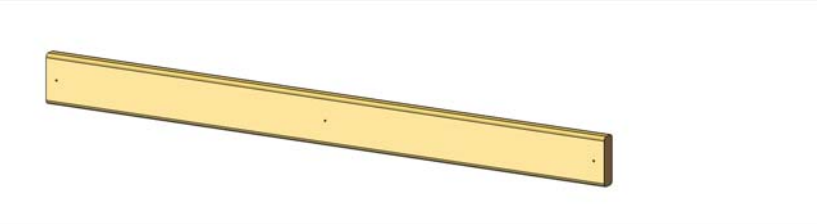
BOX 3	PICTURE	DESCRIPTION	QTY.
		$\frac{5}{4}$ X 6 X $47\frac{3}{8}$ " DECK BOARD	3
		$\frac{5}{4}$ X 6 X 28" SLAT	13
		$\frac{5}{4}$ X 6 X $23\frac{7}{8}$ " ROCK WALL SLAT NO HOLES	11
		PLASTIC COATED 4 X 6 X 120" SWING BEAM	1
		2 X 4 X 66" ROCK WALL SIDE	2
		2 X 4 X $47\frac{1}{2}$ " CENTER TARP BOARD	1
		$\frac{5}{4}$ X $3\frac{1}{2}$ X $40\frac{1}{4}$ " SPACER	1

BOX 3	PICTURE	DESCRIPTION	QTY.
		2 X 4 X 70" CENTER DECK SUPPORT	1
		2 X 4 X 70" SAFETY BOARD	2
		2 X 4 X 72" CENTER POST	1
		2 X 4 X 89 ¹ / ₂ " TOP ROPE LADDER SUPPORT	1
		2 X 4 X 58 ¹ / ₂ " SWING CROSS MEMBER	1
		2 X 4 X 54 ¹ / ₂ " END TARP BOARD	1

BOX 4	PICTURE	DESCRIPTION	QTY.
		$\frac{5}{4} \times 3\frac{1}{2} \times 40\frac{1}{2}$ SPACER	1
		$2 \times 6 \times 51$ PICNIC TABLE SEAT	1
		$2 \times 4 \times 54\frac{1}{2}$ END TARP BOARD	1
		$\frac{5}{4} \times 6 \times 51$ PICNIC TABLE TOP BOARD	2
		$2 \times 2 \times 18$ GROUND STAKE	2
		$2 \times 4 \times 30\frac{1}{2}$ PICNIC TABLE FRAME	1
		$2 \times 2 \times 16$ FLOOR SUPPORT	7

PICTURE	DESCRIPTION	QTY.
	2 X 4 X 18 ³ / ₄ " RAMP SUPPORT	3
	2 X 4 X 94" CENTER RAMP FLOOR BOARD	1
	2 X 4 X 96" RAMP SIDE	2
	2 X 6 X 94" SIDE RAMP FLOOR BOARD	2

COUNT AND ORGANIZE YOUR LUMBER INTO LIKE STACKS (2 X 4, 2 X 6, 4 X 4, 4 X 6, ETC.). THIS WILL HELP IN IDENTIFYING COMPONENTS AND REDUCE YOUR BUILDING TIME

PICTURE

DESCRIPTION

QTY.



OPEN
SPIRAL
SLIDE

1



ROPE
LADDER
ASSEMBLY

1



SWINGS
W/CHAINS

2



TRAPEZE
BAR
W/CHAINS

1

PICTURE

DESCRIPTION

QTY.

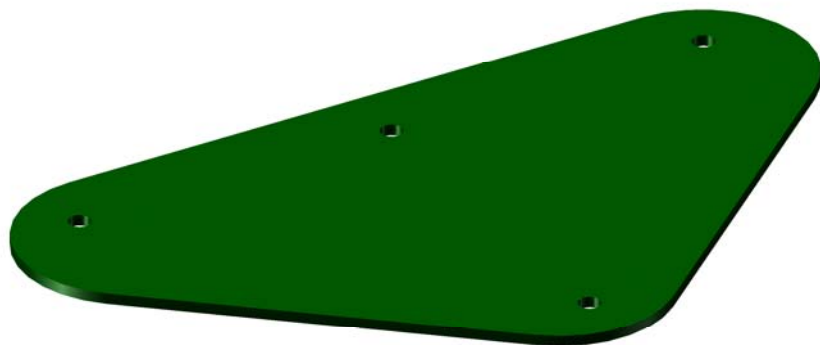

SWING
PLATE

1

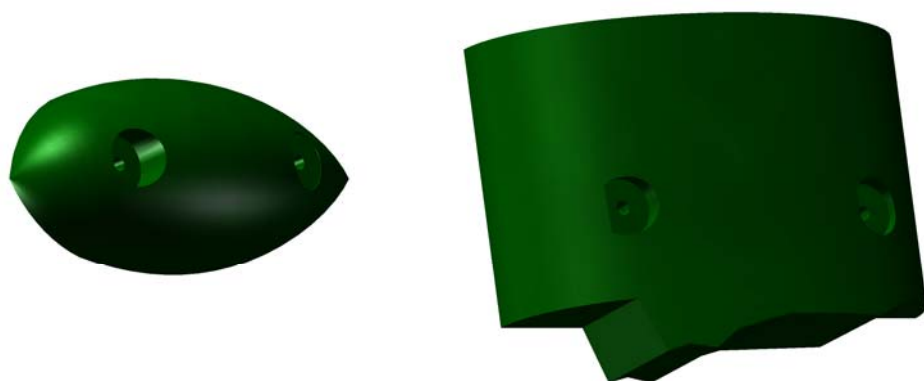

GREEN
ROCKS

10

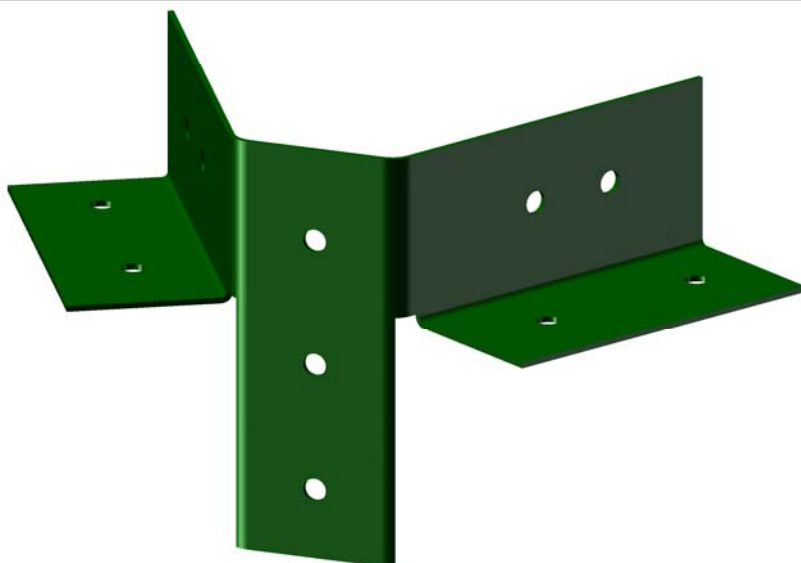

A-FRAME
SWING
LEG
BRACKET

1

NOT SHOWN

HARDWARE
BOX
INSTRUCTIONS

1
EA.

PICTURE

DESCRIPTION

QTY.



IRON
DUCTILE
SWING
HANGERS

6



$1\frac{1}{2}$ " X $1\frac{1}{2}$ "
GREEN
BRACKET

4



SPRING
CLAMP

6

PICTURE

DESCRIPTION

QTY.



10' ROPE

2



TARP

1

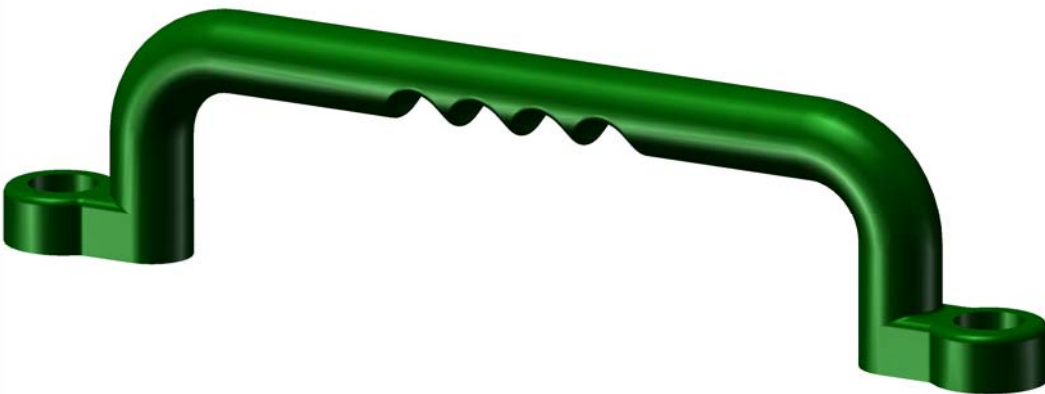

SAFETY
HANDLES

4

STEP 1: CORNER POSTS

- 1: MAKE SURE ALL HOLES ARE CLEAR OF SAWDUST AND DEBRIS. USE A 3/8" DRILL BIT OR BOLT TO CLEAR OUT THE HOLES BY SLIDING IT IN AND OUT.
- 2: INSERT T-NUTS INTO THE HOLES OF THE CORNER POSTS AS SHOWN BELOW.
- 3: SET THE T-NUTS WITH A HAMMER FLUSH TO THE SURFACE OF THE LUMBER.
- 4: FOR BEST RESULTS, SET THE T-NUTS INTO THE CORNER POSTS ONE CORNER POST AT A TIME.
- 5: DO NOT INSTALL T-NUTS IN THE HOLES AT 85".

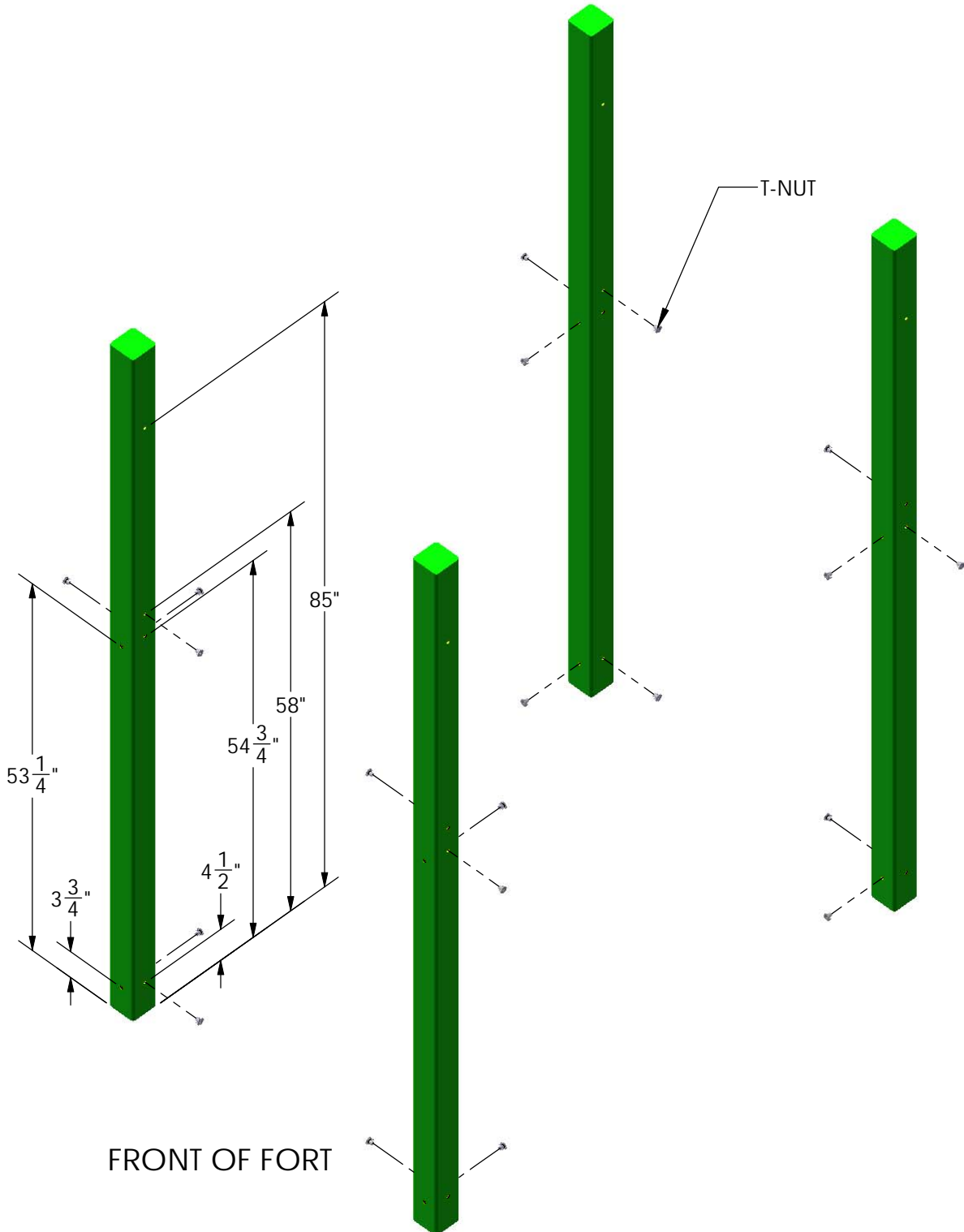

STEP 2: SANDBOX BOARDS

- 1: FIND TWO 2 X 6 X 70" SANDBOX BOARDS.
- 2: OFFSET HOLES UPWARDS, LAY ONE SANDBOX BOARD ON TOP OF THE CORNER POSTS.
- 3: USE 5/16 X 4-1/2" HEX BOLTS AND 5/16" WASHERS, AND ATTACH THE SANDBOX BOARD TO THE CORNER POSTS THROUGH THE HOLE AT 4-1/2" INTO THE T-NUTS INSTALLED IN STEP 1.

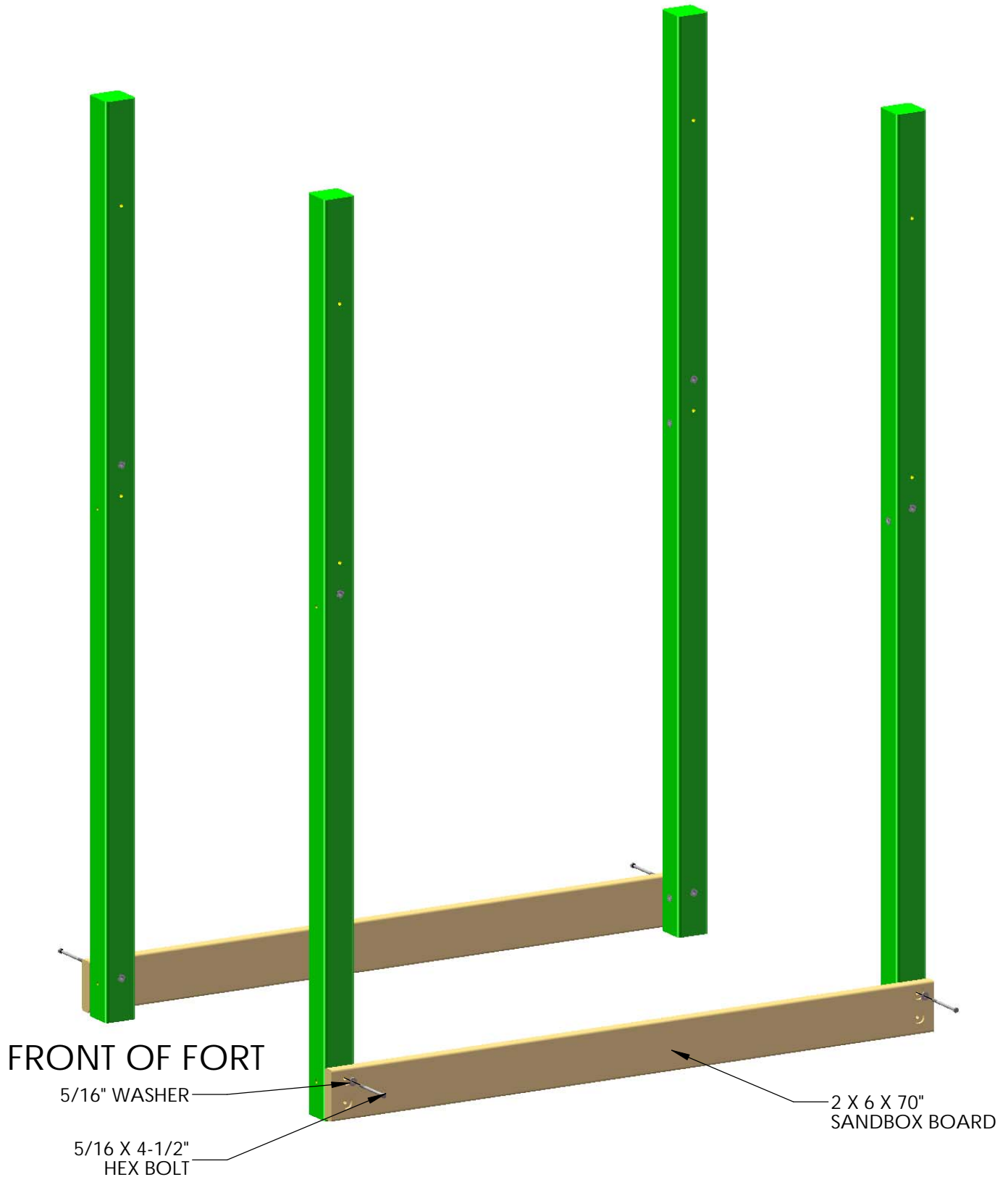

STEP 3: DECK SUPPORTS

- 1: FIND TWO 2 X 6 X 70" SANDBOX BOARDS.
- 2: OFFSET HOLES UPWARDS, LAY ONE SANDBOX BOARD ON TOP OF THE CORNER POSTS.
- 3: USE 5/16 X 4-1/2" HEX BOLTS AND 5/16" WASHERS, AND ATTACH THE SANDBOX BOARD TO THE CORNER POSTS THROUGH THE HOLE AT 4-1/2" INTO THE T-NUTS INSTALLED IN STEP 1.

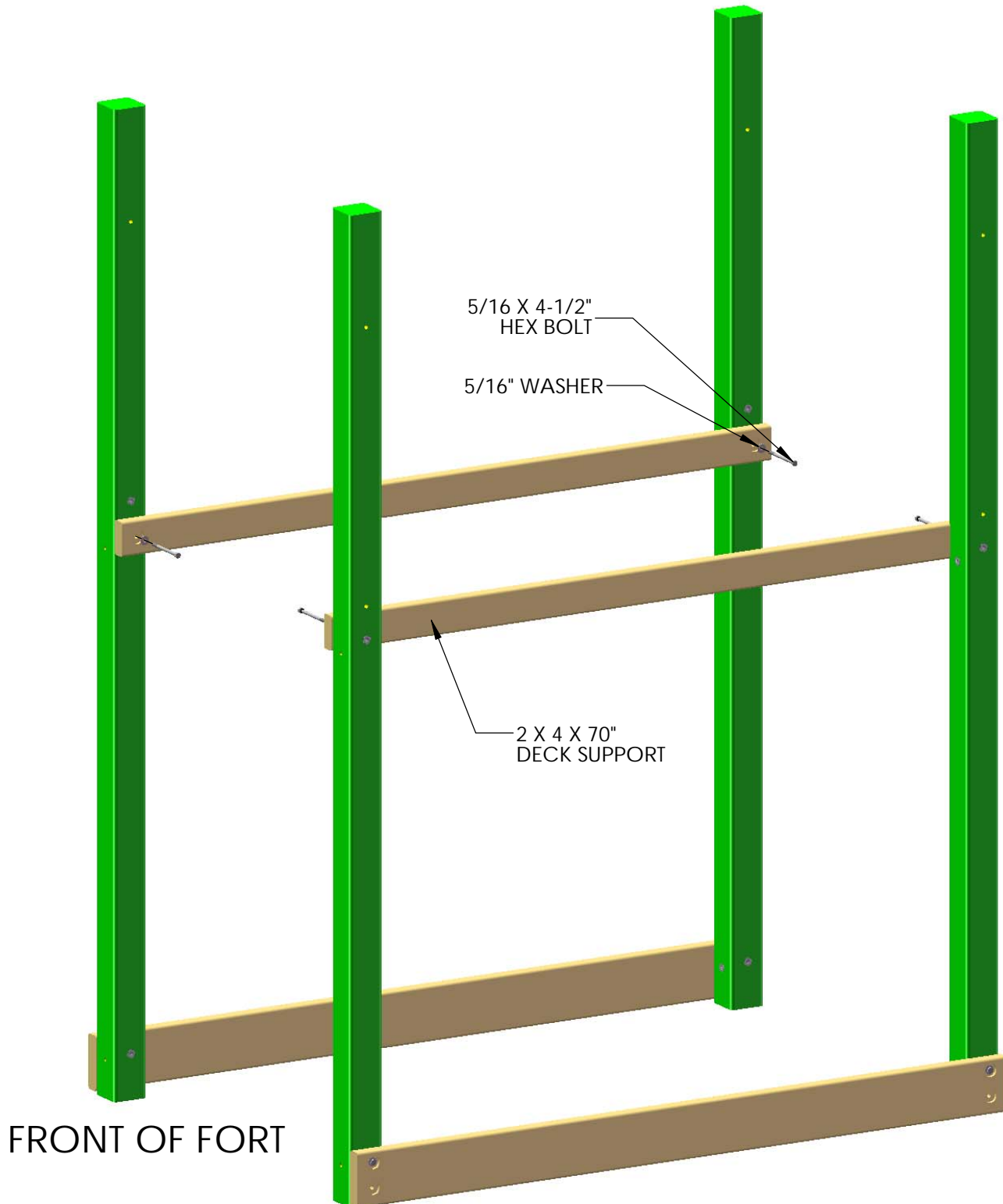

STEP 4: END PANEL BOARDS

1: FIND TWO 2 X 6 X 47-1/2" END PANEL BOARDS.

2: WITH OFFSET HOLES DOWN, ATTACH THE END PANEL BOARD TO THE CORNER POSTS WITH 5/16 X 4-1/2" HEX BOLTS AND 5/16" WASHERS THROUGH THE BOTTOM HOLES OF THE END PANEL BOARD, AND INTO THE HOLES AT 53-1/4".

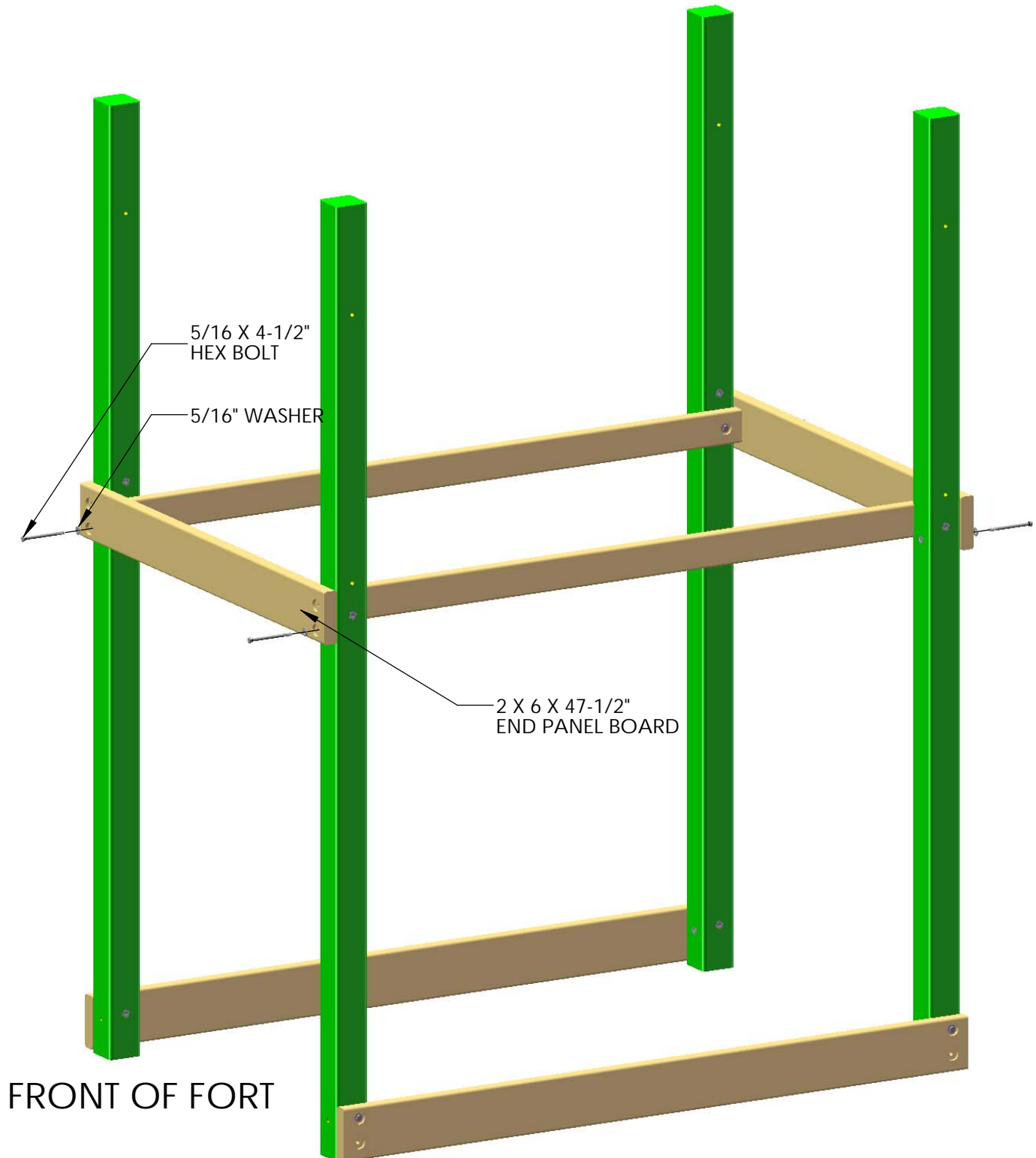

STEP 5: END SANDBOX BOARDS

1: FIND THE 2 X 6 X 47-1/2" SANDBOX BOARD (SAME AS THE END PANEL BOARDS) AND THE 2 X 6 X 89-1/2" ROPE LADDER RUNNER.

2: WITH OFFSET HOLES DOWN, ATTACH THE SANDBOX BOARD TO THE CORNER POSTS WITH 5/16 X 4-1/2" HEX BOLTS AND 5/16" WASHERS THROUGH THE TOP HOLES OF THE SANDBOX BOARD, AND INTO THE HOLES AT 3-3/4".

3: REPEAT STEP 2 WITH THE 2 X 6 X 78" ROPE LADDER RUNNER

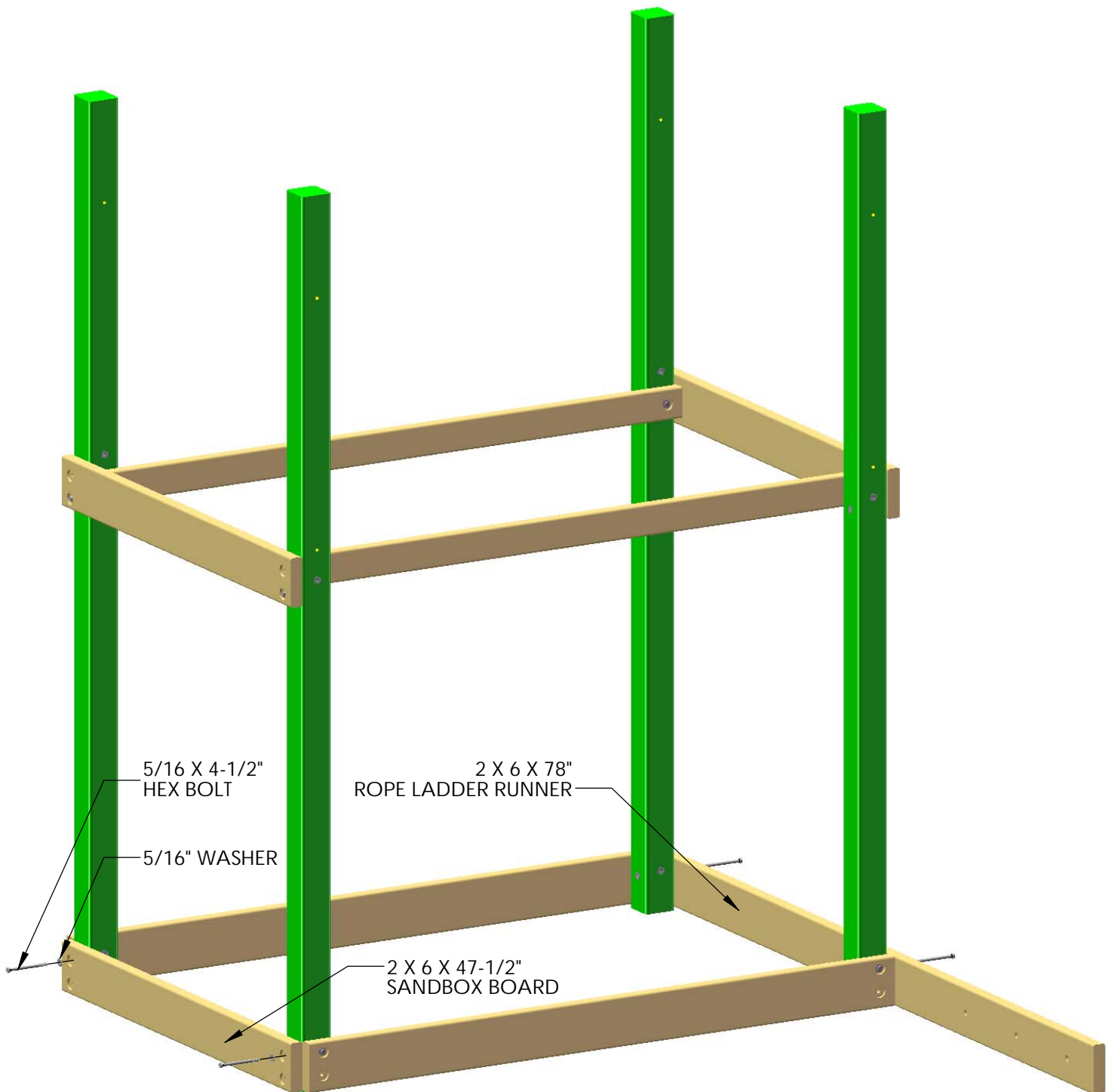

FRONT OF FORT

STEP 6: BOTTOM PANEL BOARDS

- 1: FIND THE 2 X 6 X 70" BOTTOM PANEL BOARD, AND THE 2 X 6 X 70" ROCK WALL PANEL BOARD.
- 2: WITH OFFSET HOLES UP, ATTACH THE ROCK WALL PANEL BOARD TO THE CORNER POSTS WITH 5/16 X 4-1/2" HEX BOLTS AND 5/16" WASHERS THROUGH THE TOP HOLES OF THE ROCK WALL PANEL BOARD, AND INTO THE HOLES AT 58-1/2".
- 3: REPEAT STEP 2 WITH THE 2 X 6 X 70" BOTTOM PANEL BOARD.

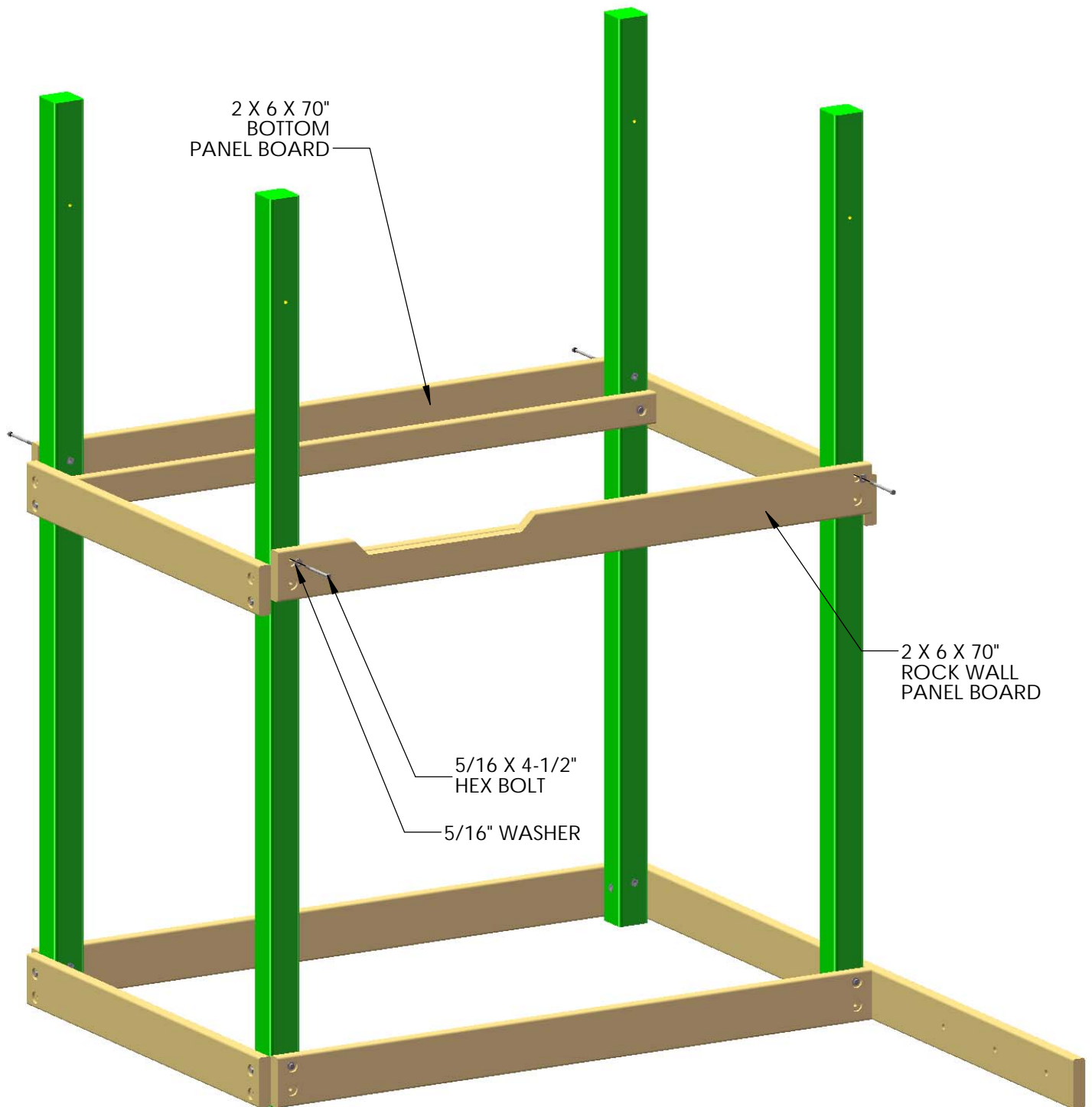

FRONT OF FORT

STEP 7: TOP SIDE RAILS

- 1: FIND THE 4 X 4 X 94" SWING BEAM MOUNT AND THE 4 X 4 X 94" TOP SIDE RAIL.
- 2: ON THE SIDE OF THE FORT WITHOUT THE ROCK WALL CUT OUT PLACE THE 4 X 4 X 94" SIDE RAIL WITH SWING BEAM MOUNT, COUNTER-SUNK HOLES DOWN, AND ATTACH AT THE HOLES AT 85" USING 6-1/2" CARRIAGE BOLTS WITH 1/2" WASHERS FROM THE INSIDE, AND 3/8" WASHERS AND 3/8" LOCK NUTS FROM THE OUTSIDE, HOLDING THE HEAD OF THE CARRIAGE BOLT WITH VICE GRIPS. (SEE DETAIL VIEWS BELOW)
- 3: REPEAT STEP 2 TO MOUNT THE 4 X 4 X 94" TOP SIDE RAIL TO THE OPPOSITE SIDE OF THE FORT. THE TOP SIDE RAIL DOES NOT HAVE ANY HOLES DRILLED FOR A SWING BEAM MOUNT.
- 4: PLACE GREEN BOLT CAPS OVER EXPOSED THREADS OF BOLTS.

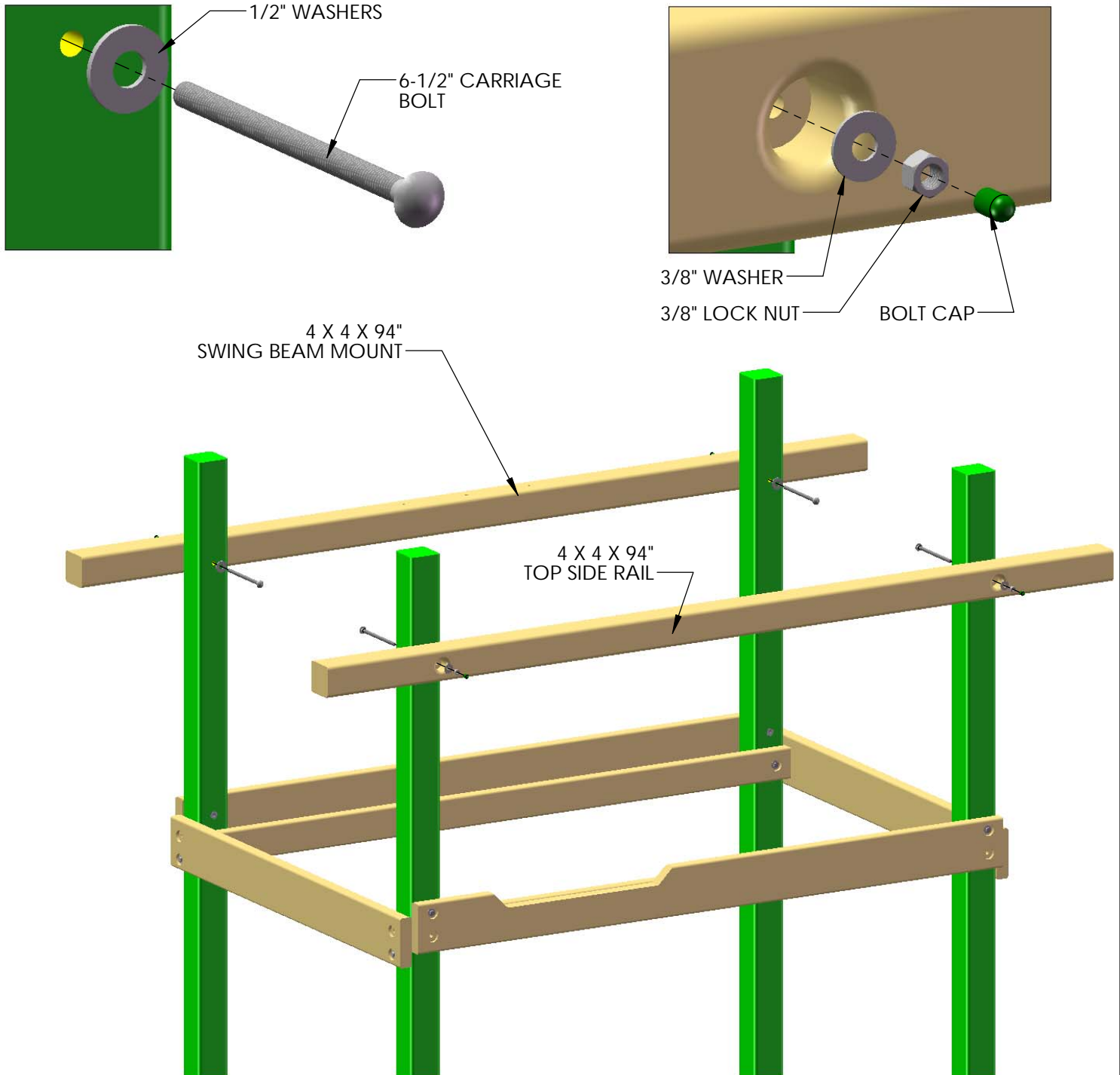

FRONT OF FORT

STEP 8: SQUARE AND LEVEL

1: USE 5/16 X 3-1/2" LAG SCREWS AND 5/16" WASHERS IN THE SECOND HOLE OF EACH 2 X 6 CHECKING THAT THE UNIT IS LEVEL AND SQUARE AFTER COMPLETING EACH POST.

NOTE: IF USING A RATCHET, TAP LAG SCREW IN WITH A HAMMER TO START.

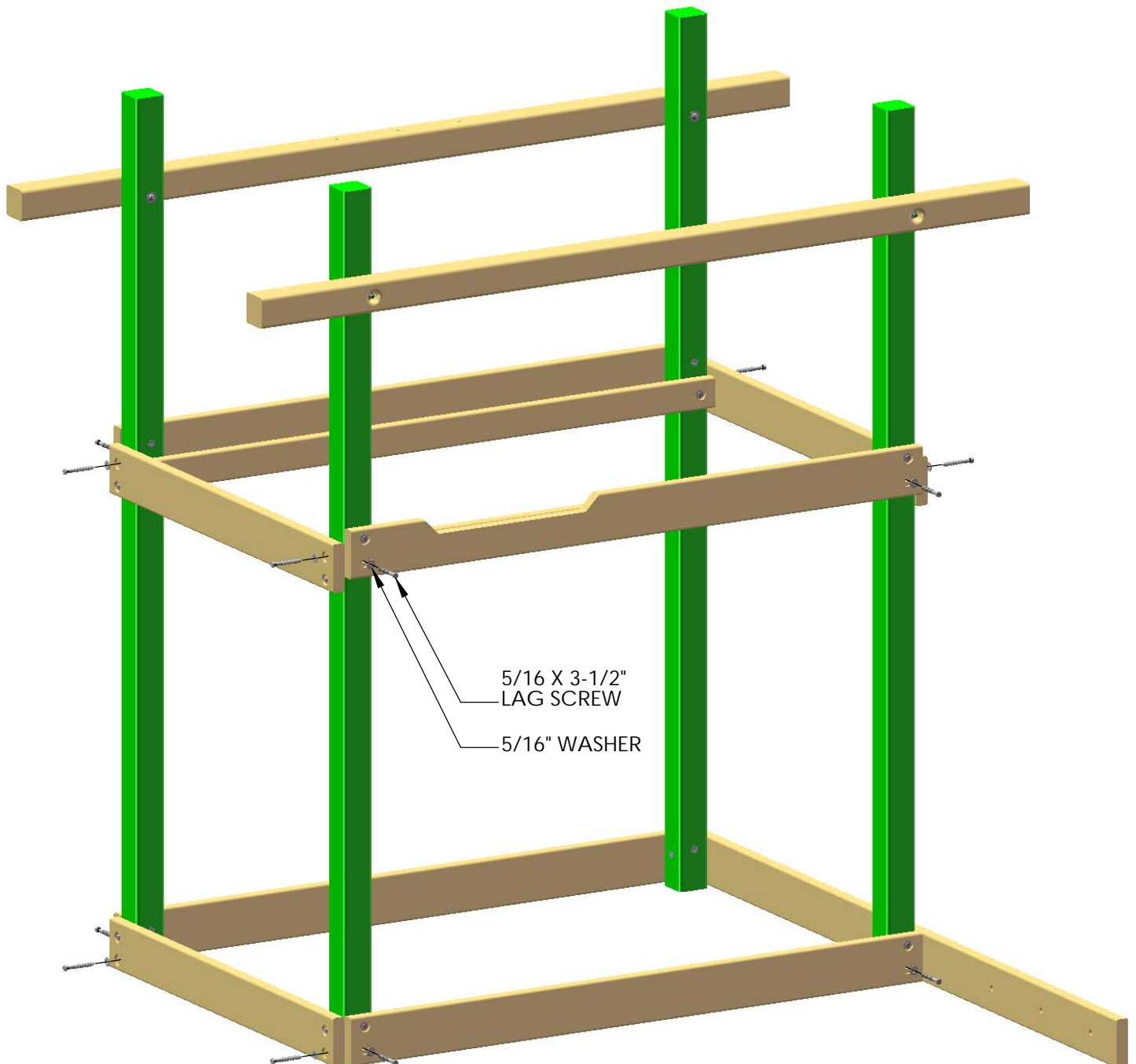

STEP 9: DECK SPACERS

- 1: FIND THE TWO 5/4 X 4 X 40-1/4" DECK SPACERS.
- 2: PLACE EACH DECK SPACER ON TOP OF THE DECK SUPPORTS BETWEEN THE CORNER POSTS.
- 3: USE ONE 2" WOOD SCREW ON EACH END OF THE BOARD ATTACHING IT TO THE DECK SUPPORTS.

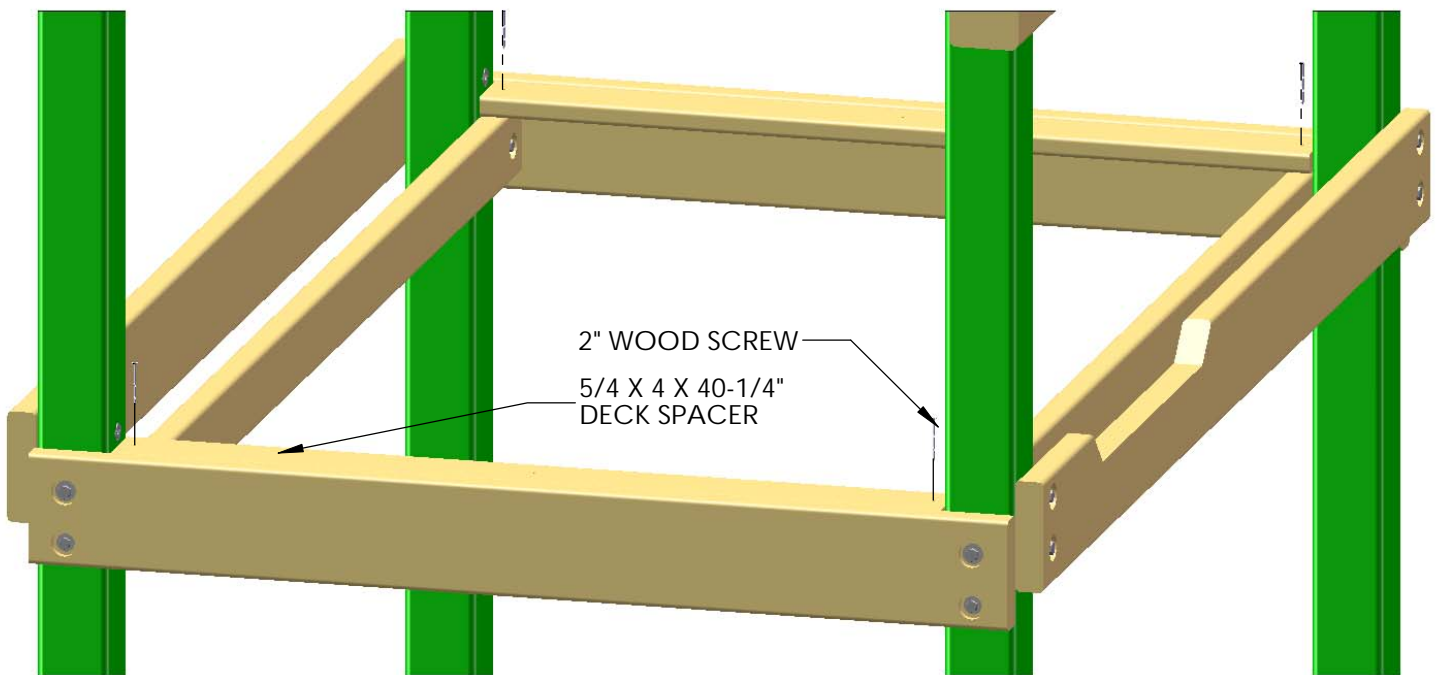

FRONT OF FORT

STEP 10: DECK SUPPORT

- 1: FIND THE 2 X 4 X 70" DECK SUPPORT.
- 2: FIND THE CENTER OF THE DECK SPACERS.
- 3: ATTACH THE DECK SUPPORT TO THE BOTTOM OF THE DECK SPACER WITH ONE 2" WOOD SCREW ON EACH END.
- 4: SECURE THE DECK SUPPORT WITH TWO 2-1/2" WOOD SCREWS INTO EACH END OF THE DECK SUPPORT THROUGH THE END PANEL BOARD.

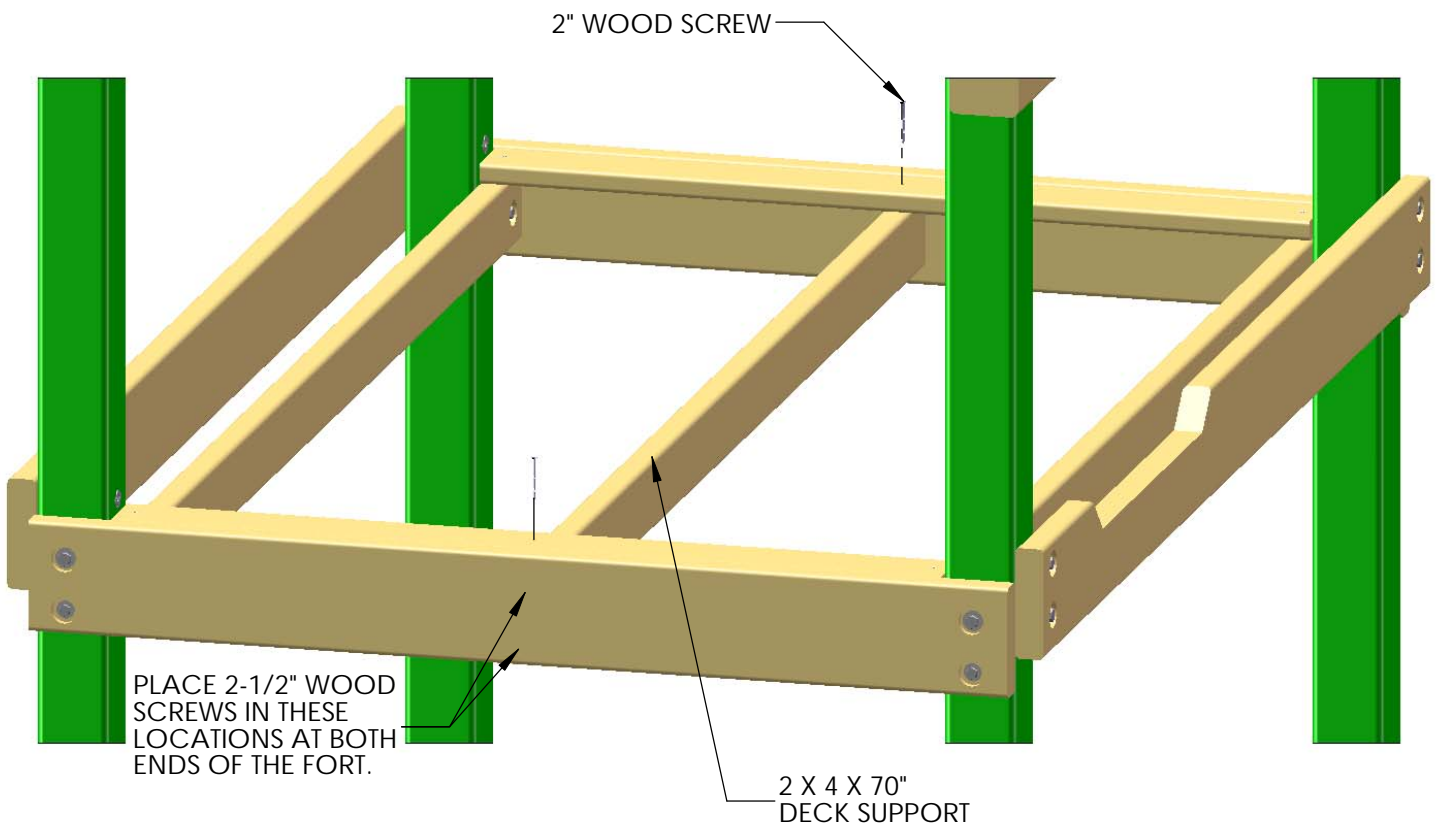

FRONT OF FORT

STEP 11: DECK BOARDS

- 1: FIND ELEVEN 5/4 X 6 X 47-3/8" DECK BOARDS.
- 2: LAY THE DECK BOARDS EVENLY ACROSS THE DECK SUPPORTS.
- 3: ATTACH EACH BOARD WITH TWO 2" WOOD SCREWS IN EACH END, AND ONE IN THE CENTER OF EACH BOARD.

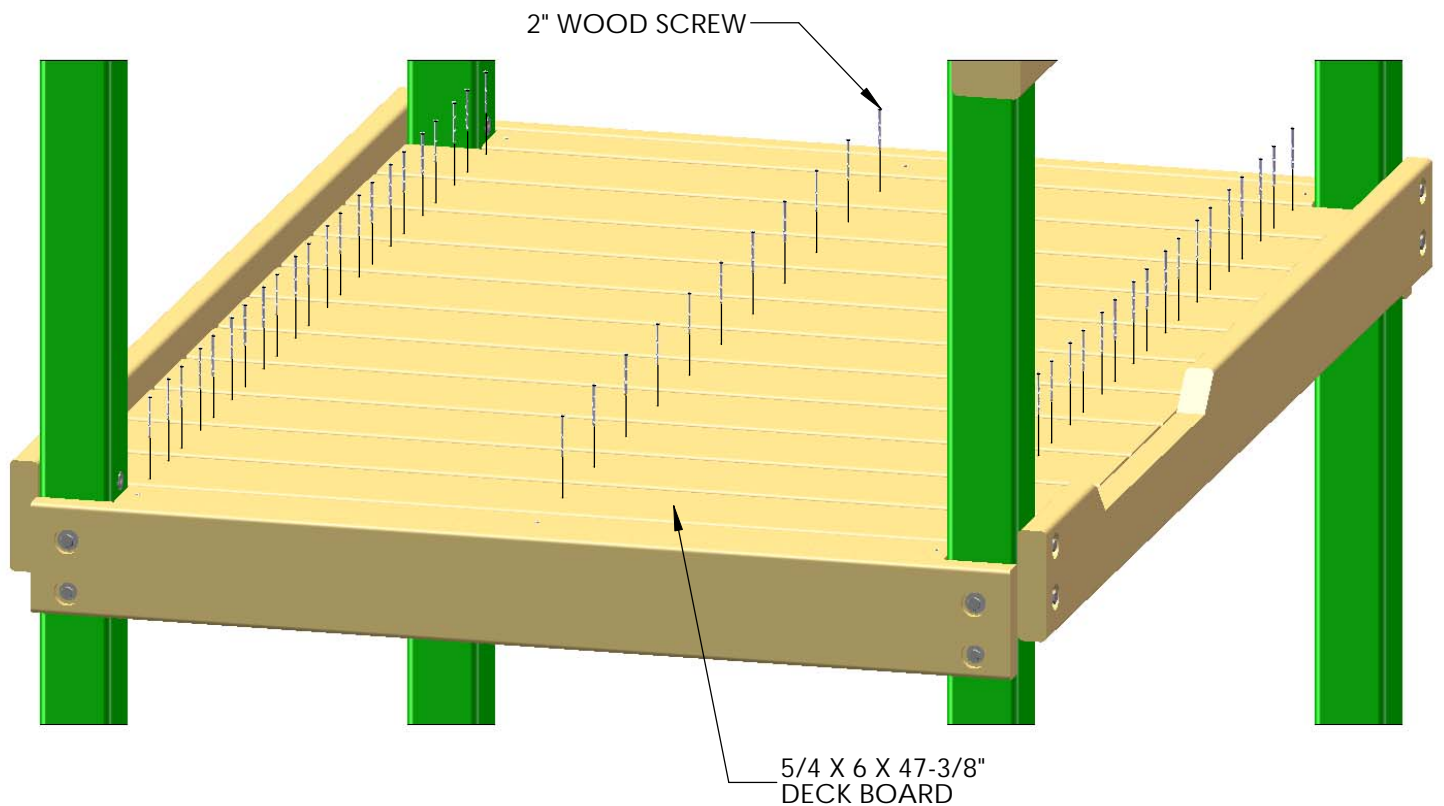

FRONT OF FORT

STEP 12: END TOP PANEL BOARDS

1: FIND THE TWO 2 X 4 X 47-1/2" END TOP PANEL BOARDS.

2: WITH OFFSET HOLES DOWN, PLACE ON THE CORNER POSTSEVEN WITH THE 4 X 4 X 94" TOP SIDE RAILS. (SEE DIAGRAM BELOW FOR PLACEMENT OF END TOP PANEL BOARD WITH THREE HOLES). ATTACH WITH 5/16 X 3-1/2" LAG SCREWS AND 5/16" WASHERS.

3: FIND THE 2 X 4 X 78" TOP ROPE LADDER SUPPORT, AND PLACE THE BOTTOM FLUSH TO THE TOP OF THE TOP SIDE RAILS ON THE REAR OF THE FORT. INSTALL WITH 5/16 X 3-1/2" LAG SCREWS AND 5/16" WASHERS.

NOTE: IF USING A RATCHET, TAP THE LAG SCREWS WITH A HAMMER TO START.

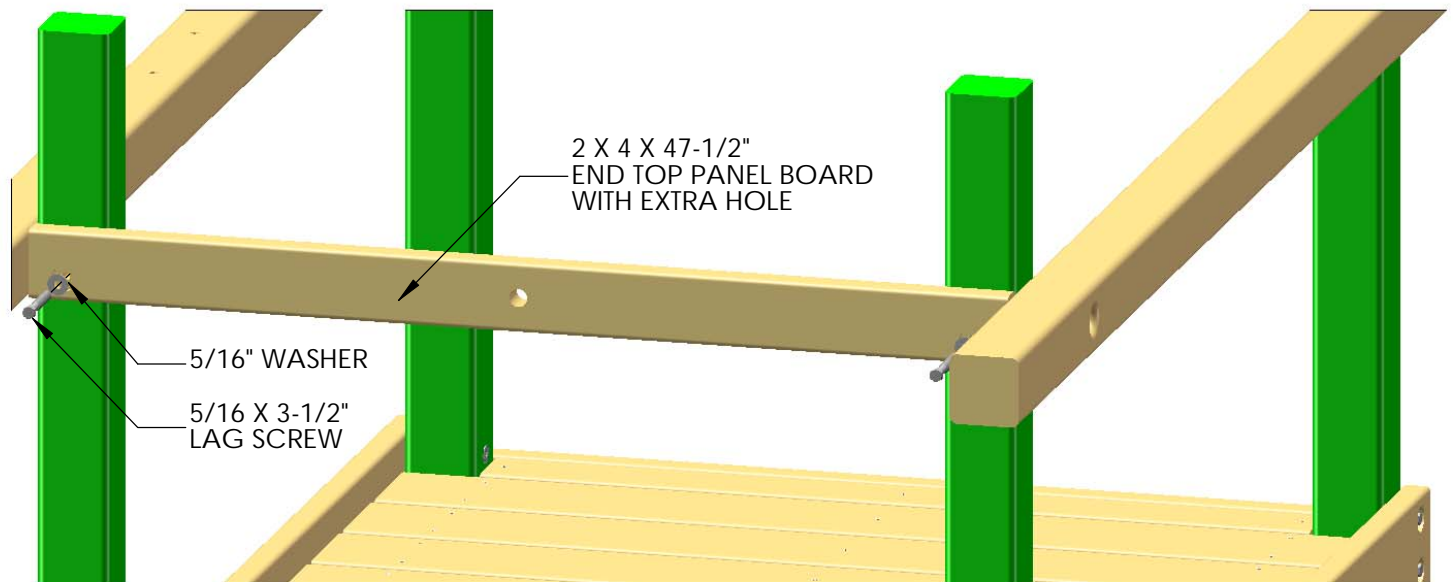

FRONT OF FORT

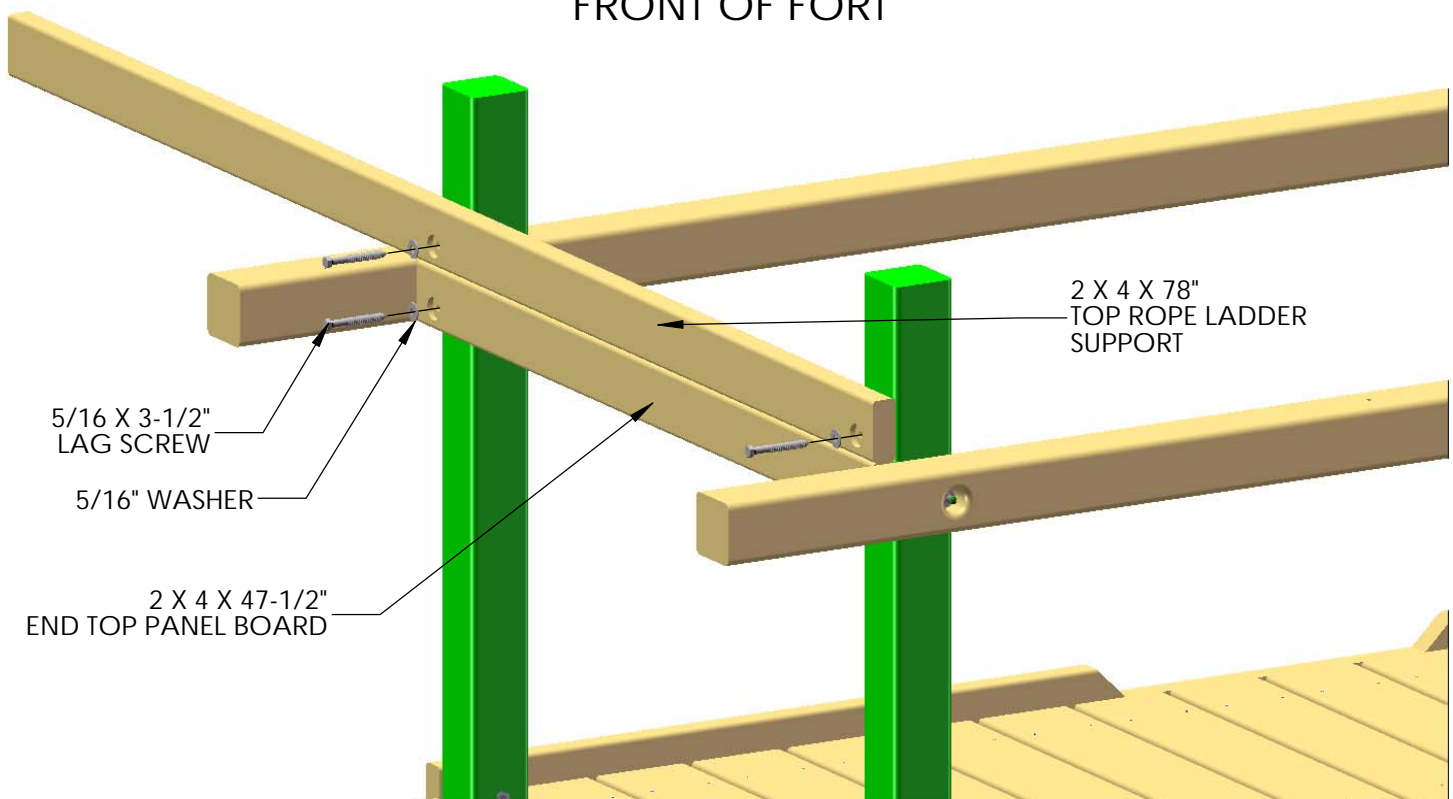

REAR OF FORT

STEP 13: END BOTTOM PANEL BOARDS

- 1: FIND THE FOUR 2 X 4 X 12" END BOTTOM PANEL BOARDS.
- 2: PLACE ON TOP OF THE END PANEL BOARDS FLUSH WITH THE CORNER POSTS.
- 3: INSTALL WITH 5/16 X 3-1/2" LAG SCREWS AND 5/16" WASHERS.
- 4: REPEAT PROCESS FOR THE OPPOSITE SIDE OF THE FORT.

NOTE: IF USING A RATCHET, TAP THE LAG SCREWS WITH A HAMMER TO START.

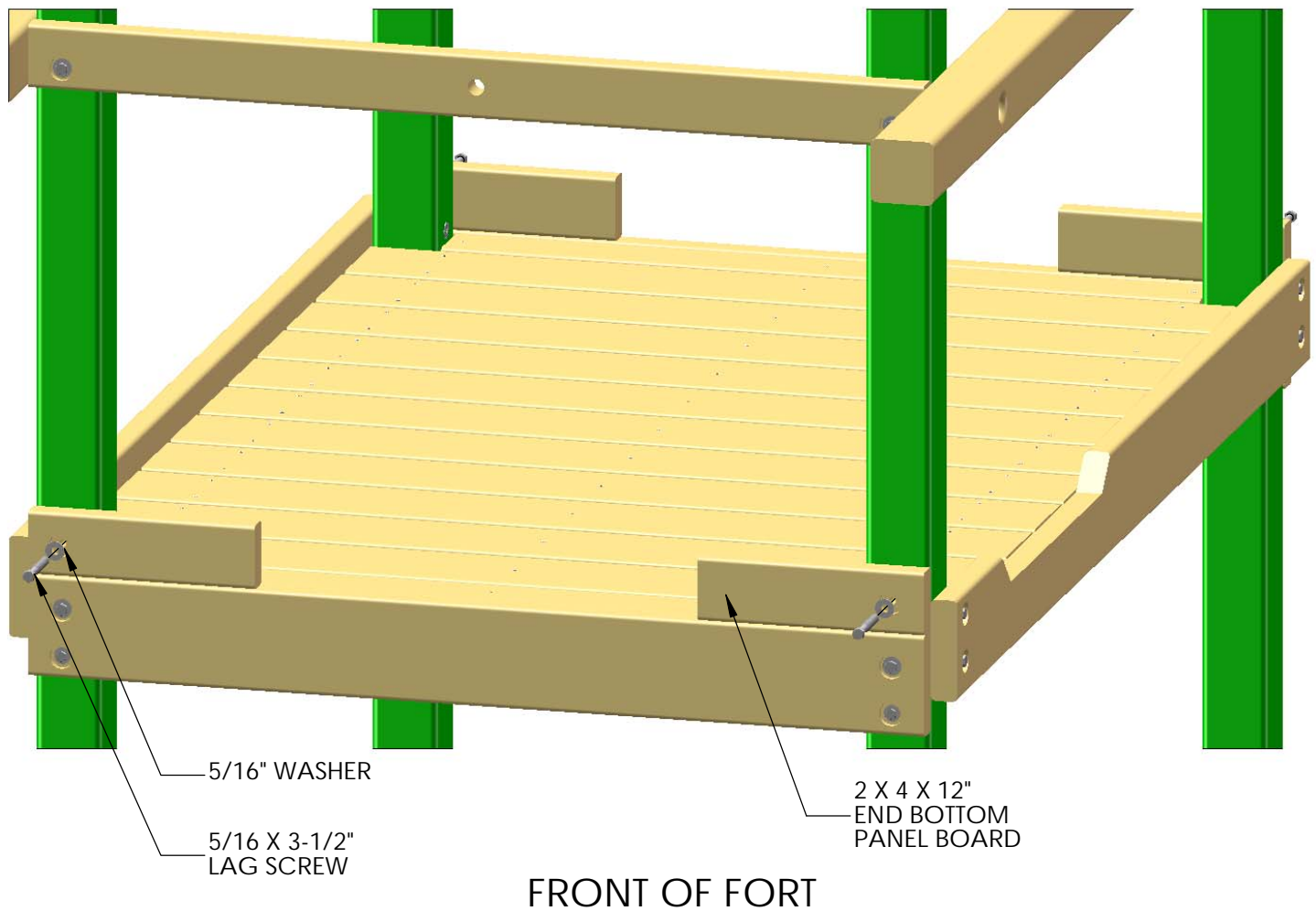

STEP 14: CLIMBING RAMP

1: PLACE ONE 2 X 4 X 18-3/4" RAMP SUPPORT BOARD AT THE END OF THE 2 X 4 X 96" RAMP SIDE BOARDS. OFFSET THE BOARD 1" FROM THE EDGE. FASTEN THE RAMP SUPPORT BOARD TO THE RAMP SIDE BOARDS WITH TWO 2-1/2" WOOD SCREWS PER SIDE.

2: PLACE ONE 2 X 4 X 18-3/4" RAMP SUPPORT BOARD AT THE ANGLED END OF THE 2 X 4 X 96" RAMP SIDE BOARDS. OFFSET THE BOARD 1" FROM THE EDGE. FASTEN THE RAMP SUPPORT BOARD TO THE RAMP SIDE BOARDS WITH TWO 2-1/2" WOOD SCREWS PER SIDE.

3: PLACE THE REMAINING 2 X 4 X 18-3/4" RAMP SUPPORT BOARD ACROSS THE RAMP SIDE BOARDS IN THE MIDDLE, AND FASTEN WITH TWO 2-1/2" WOOD SCREWS PER SIDE

NOTE: RAMP TO BE INSTALLED IN LIEU OF LADDER ON THIS MODEL. LADDER IS INCLUDED IN THE PACKAGE BUT NOT USED.

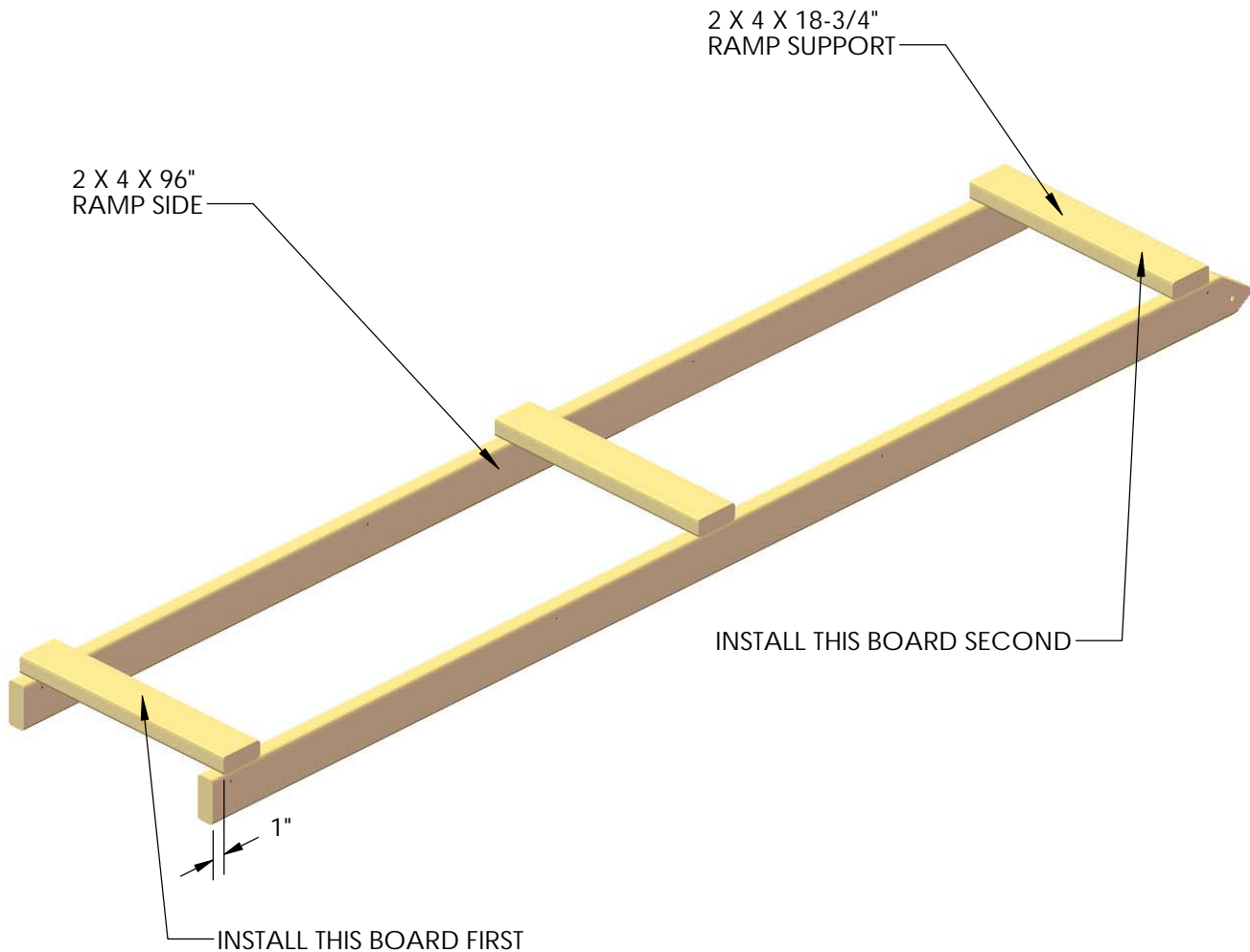

STEP 15: CLIMBING RAMP

1: PLACE ONE 2 X 6 X 94" FLOOR BOARD AGAINST EACH OF THE RAMP SIDE BOARDS. FASTEN THE FLOOR BOARDS TO THE RAMP SUPPORT BOARDS WITH TWO 2-1/2" WOOD SCREWS PER SUPPORT.

2: PLACE THE 2 X 4 X 94" FLOOR BOARD ON THE CENTER OF THE RAMP. THE HOLE AT 7" SHOULD BE TOWARDS THE ANGLED END OF THE RAMP. FASTEN THE FLOOR BOARD TO THE RAMP SUPPORT BOARDS WITH TWO 2-1/2" WOOD SCREWS PER SUPPORT.

3: PLACE ONE 2-1/2" WOOD SCREW THROUGH THE RAMP SIDE BOARDS, ABOVE EACH OF THE RAMP SUPPORTS INTO THE FLOOR BOARDS.

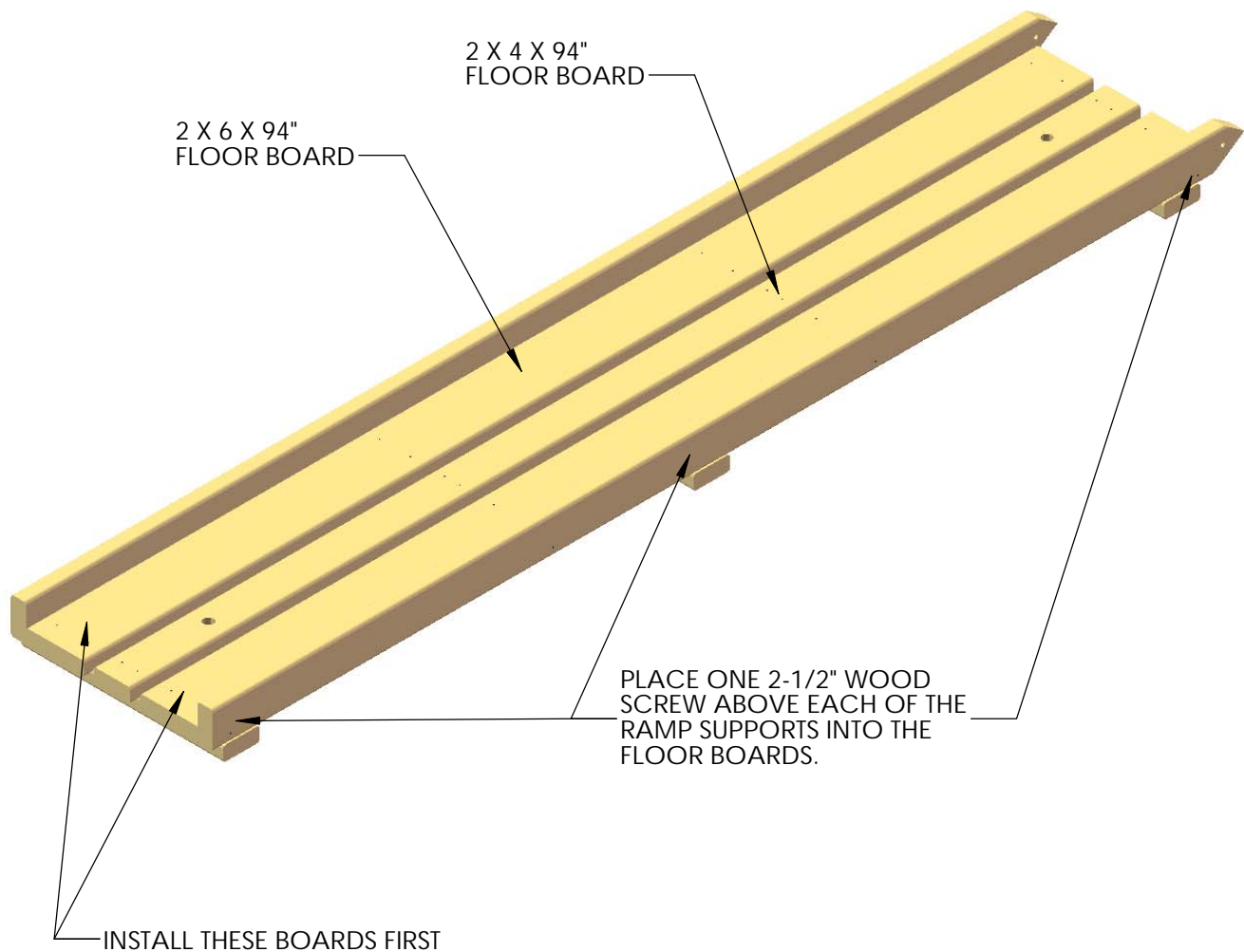

STEP 16: CLIMBING RAMP

1: ATTACH THE 2 X 2 X 16" FLOOR SUPPORT BOARDS TO THE FLOOR BOARDS WITH 2-1/2" WOOD SCREWS. (SEE DETAIL VIEW BELOW)

2: PLACE T-NUTS ON THE INSIDE OF THE HOLES IN THE RAMP SIDE BOARDS. SET THE T-NUTS WITH A HAMMER FLUSH/NEAR FLUSH WITH THE RAMP SIDES.

3: FASTEN THE 90° GREEN BRACKET TO THE RAMP SIDES WITH 5/16 X 1-1/2" HEX BOLTS AND 5/16" WASHERS.

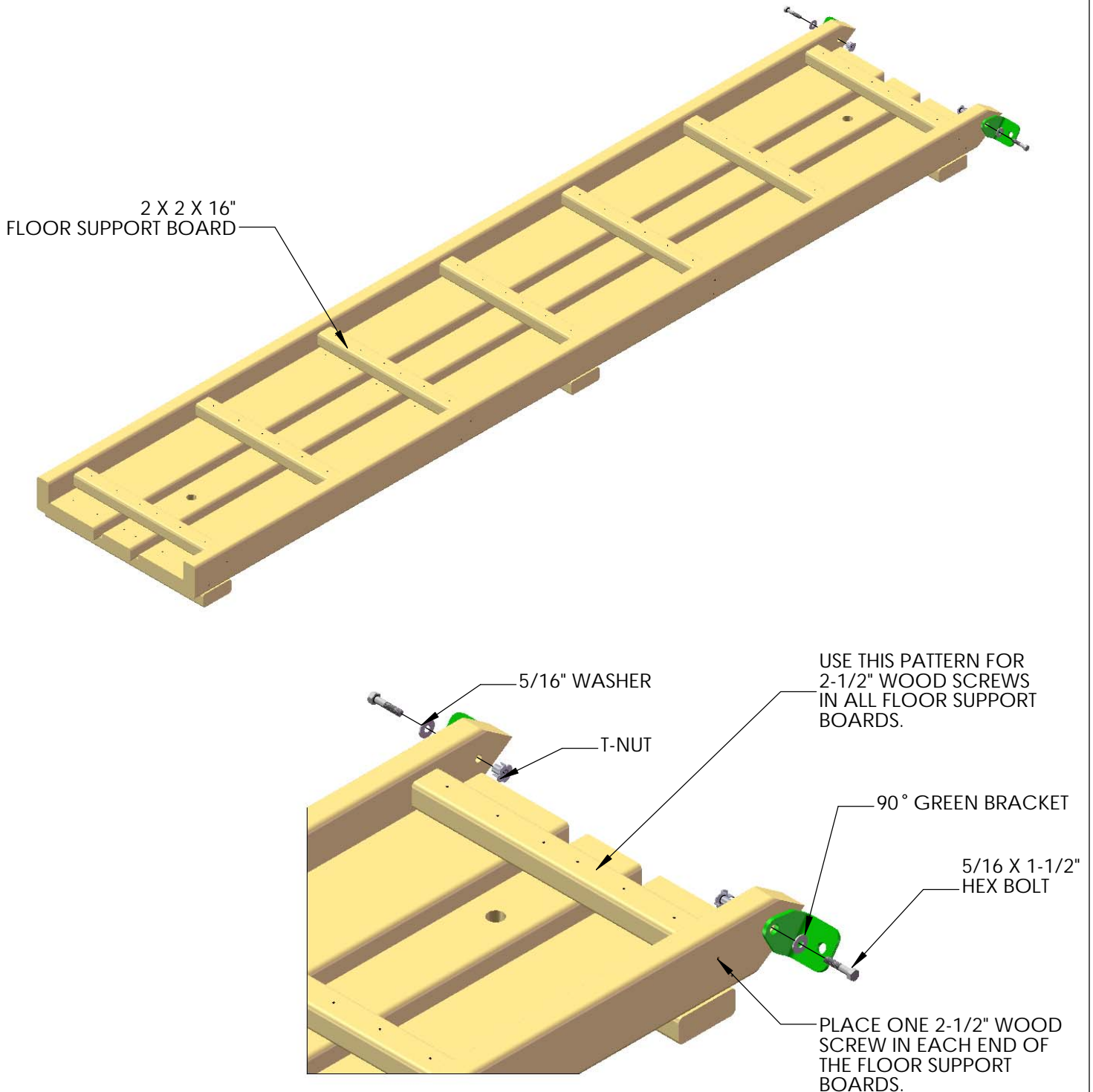

STEP 17: ATTACHING THE LADDER TO THE FORT

- 1: CENTER THE LADDER ASSEMBLY TO THE REAR (ROPE LADDER SIDE) OF THE FORT.
- 2: MOUNT THE LADDER TO THE OPENING. ALIGN BRACKETS 1/2" UP FROM THE BOTTOM OF THE 2 X 6 BOTTOM PANEL BOARD. MARK AND DRILL TWO 3/8" HOLES. INSTALL TWO 5/16" T-NUTS ON THE BACK SIDE OF THE BOARD. INSTALL THE LADDER WITH TWO 5/16 X 1-1/2" BOLTS AND 5/16" WASHERS INTO THE T-NUTS.
- 3: TIE A KNOT AT ONE END OF THE OTHER PIECE OF ROPE AND THREAD IT THROUGH THE BOTTOM HOLE OF THE CLIMBING RAMP FROM THE BACK TO THE FRONT.
- 4: THE UNTIED END WILL GO THROUGH THE HOLE AT THE TOP OF THE RAMP. TIE A SECURE KNOT AT THE END MAKING SURE THAT THE ROPE IS TIGHT AND WILL NOT WRAP AROUND YOUR HAND.

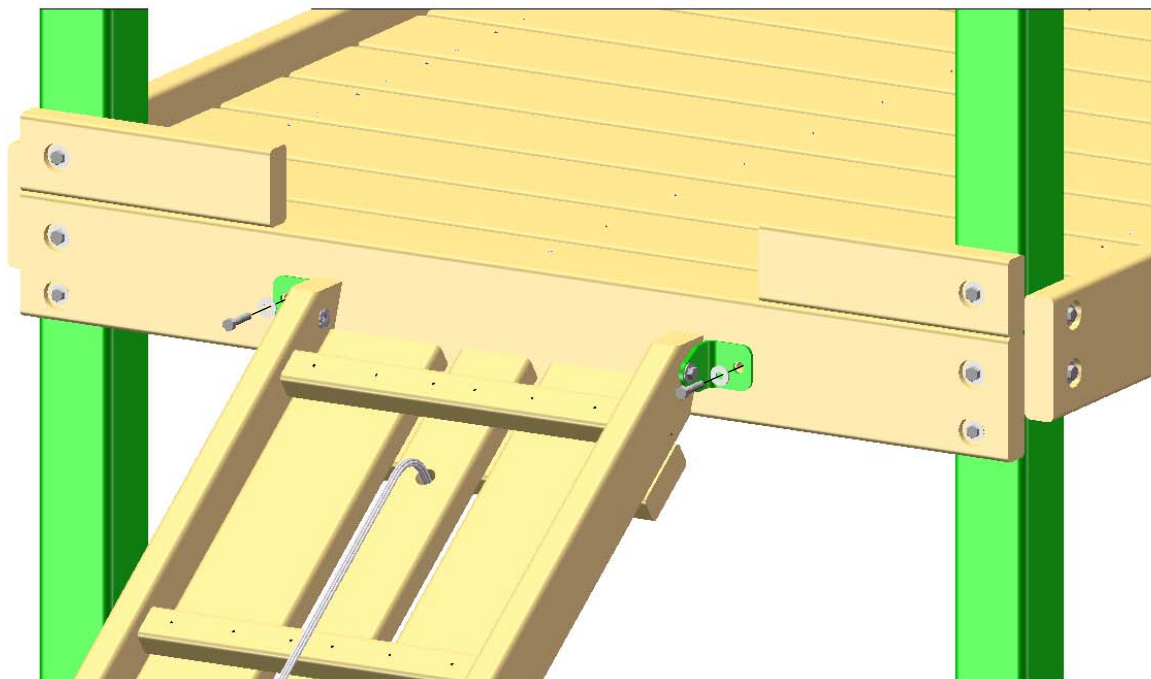
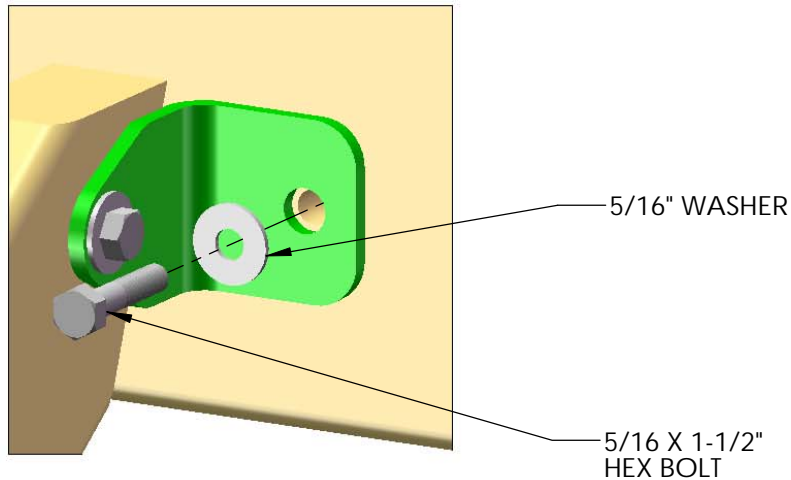

REAR OF FORT

STEP 18: CENTER POST

- 1: FIND THE TWO 2 X 4 X 72" CENTER POST BOARDS.
- 2: MARK THE CENTER OF THE UNIT AT 35"
- 3: ATTACH THE CENTER POST AT THE BOTTOM; FROM THE OUTSIDE; THROUGH THE SIDE BOTTOM PANEL BOARD WITH TWO 2-1/2" WOOD SCREWS.
- 4: ATTACH FROM THE INSIDE TO THE SIDE RAIL WITH THREE 2-1/2" WOOD SCREWS, MAKING SURE TO KEEP THE CENTER POST SQUARED AND CENTERED.
- 5: REPEAT STEPS 2 - 4 WITH SECOND CENTER POST BOARD.

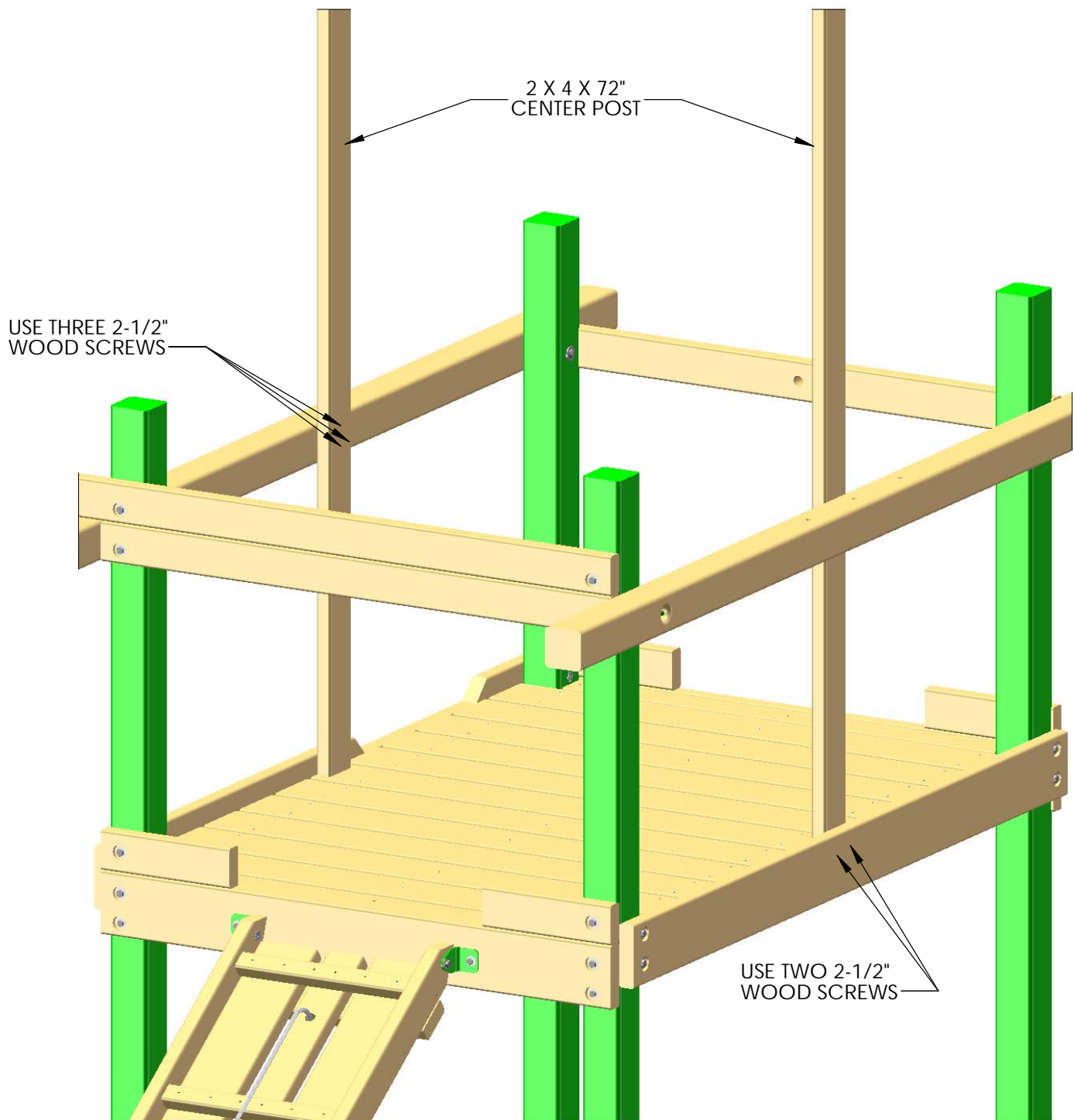

REAR OF FORT

STEP 19: CENTER TARP BOARD

- 1: FIND THE 2 X 4 X 47-1/2" CENTER TARP BOARD.
- 2: START TWO 2-1/2" WOOD SCREWS ABOUT HALFWAY INTO EACH END.
- 3: PLACE ON TOP OF CENTER POSTS AND ATTACH.

USE TWO 2-1/2"
WOOD SCREWS

2 X 4 X 47-1/2"
CENTER TARP BOARD

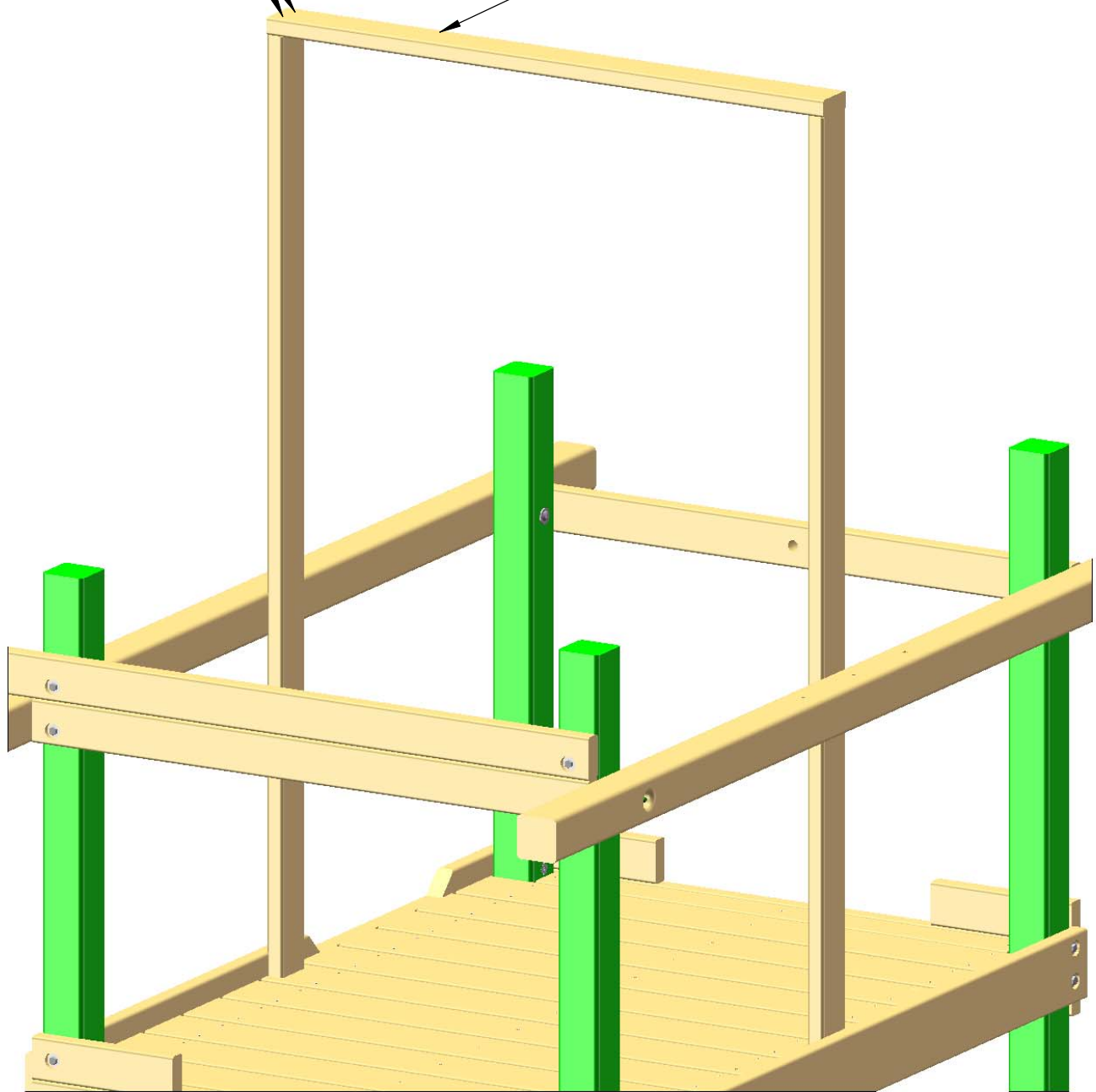

REAR OF FORT

STEP 20: END TARP BOARDS

- 1: FIND THE TWO 2 X 4 X 54-1/2" END TARP BOARDS.
- 2: START THREE 2-1/2" WOOD SCREWS ABOUT HALFWAY INTO EACH END.
- 3: PLACE ON ENDS OF TOP SIDE RAILS AND ATTACH.

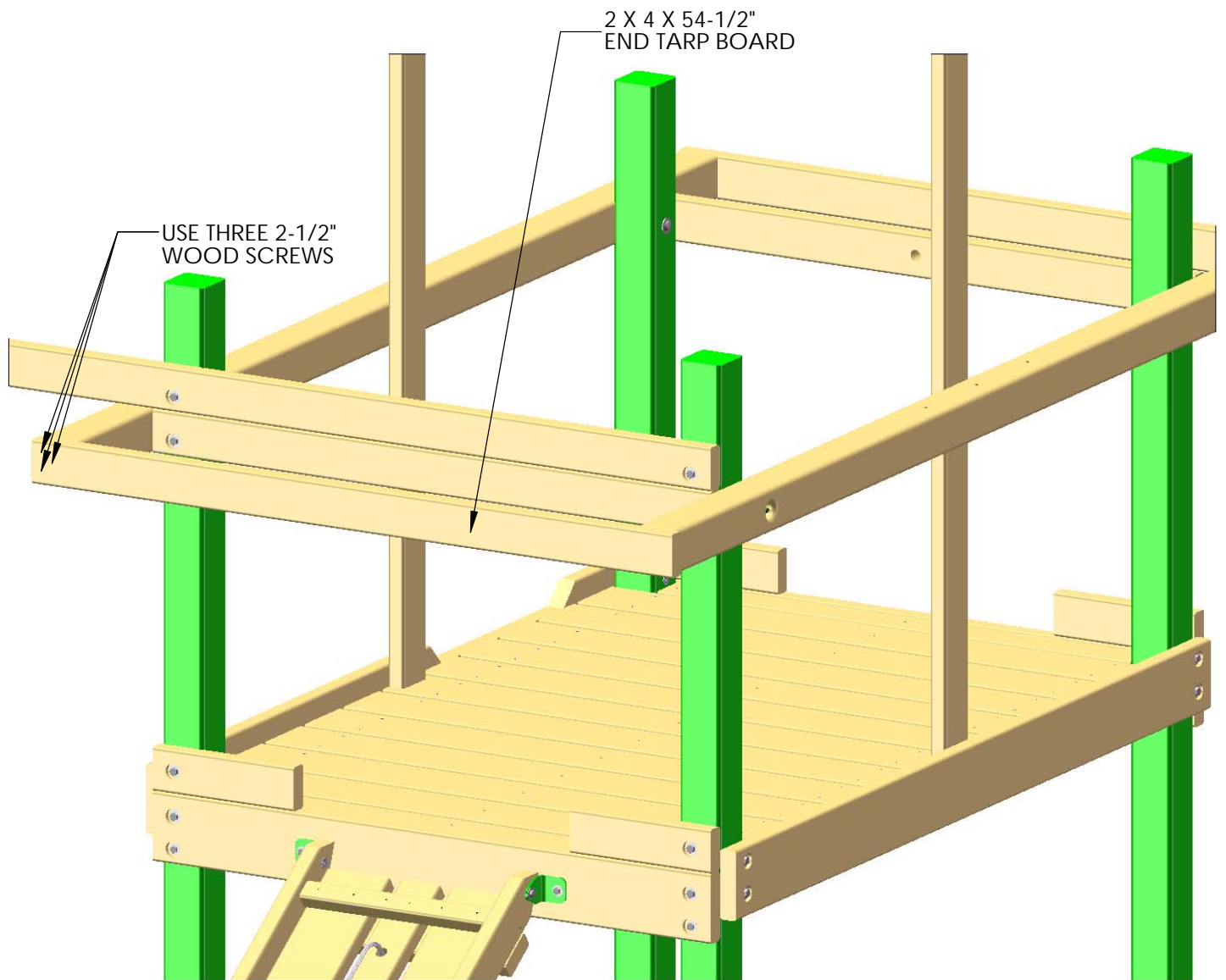

REAR OF FORT

STEP 21: WALL PANELS

- 1: FIND THE THIRTEEN 5/4 X 6 X 28" WALL PANEL SLATS.
- 2: INSTALL WALL PANEL SLATS WITH TWO 2" WOOD SCREWS PER END.
- 3: SPACE BOARDS EVENLY, SEE PICTURE BELOW FOR PLACEMENT. THERE WILL BE APPROXIMATELY 3-1/4" BETWEEN BOARDS, BUT NO MORE THAN 3-1/2".

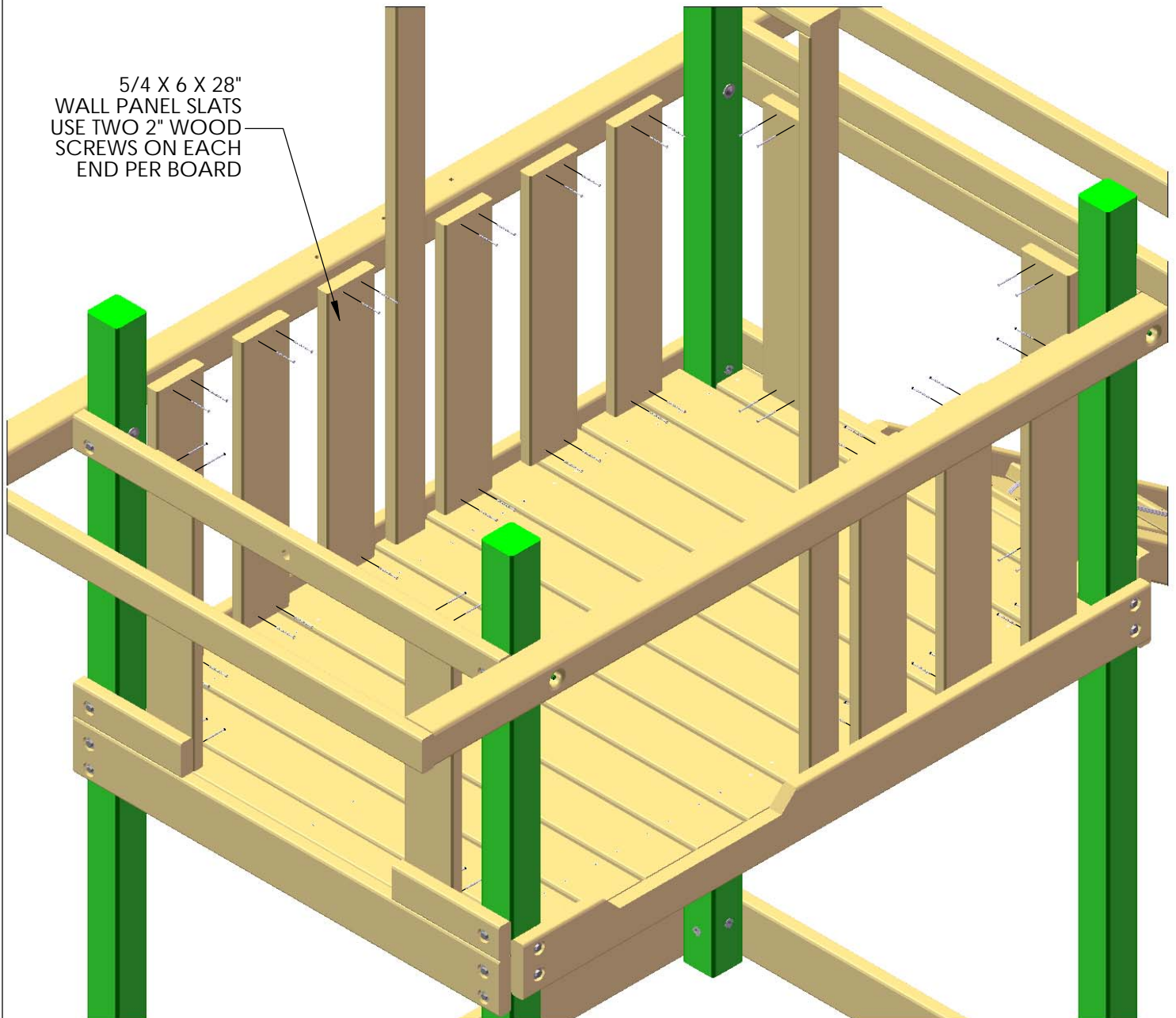

STEP 22: ROCK WALL

- 1: FIND TWO 2 X 4 X 66" ROCK WALL SIDES.
- 2: POSITION THE ROCK WALL SIDES SO THAT THE HOLES IN THE BOARDS ARE BOTH FACING THE SAME WAY.
- 3: INSERT T-NUTS INTO THE INSIDE OF THE ROCK WALL SIDES AND SET WITH A HAMMER.

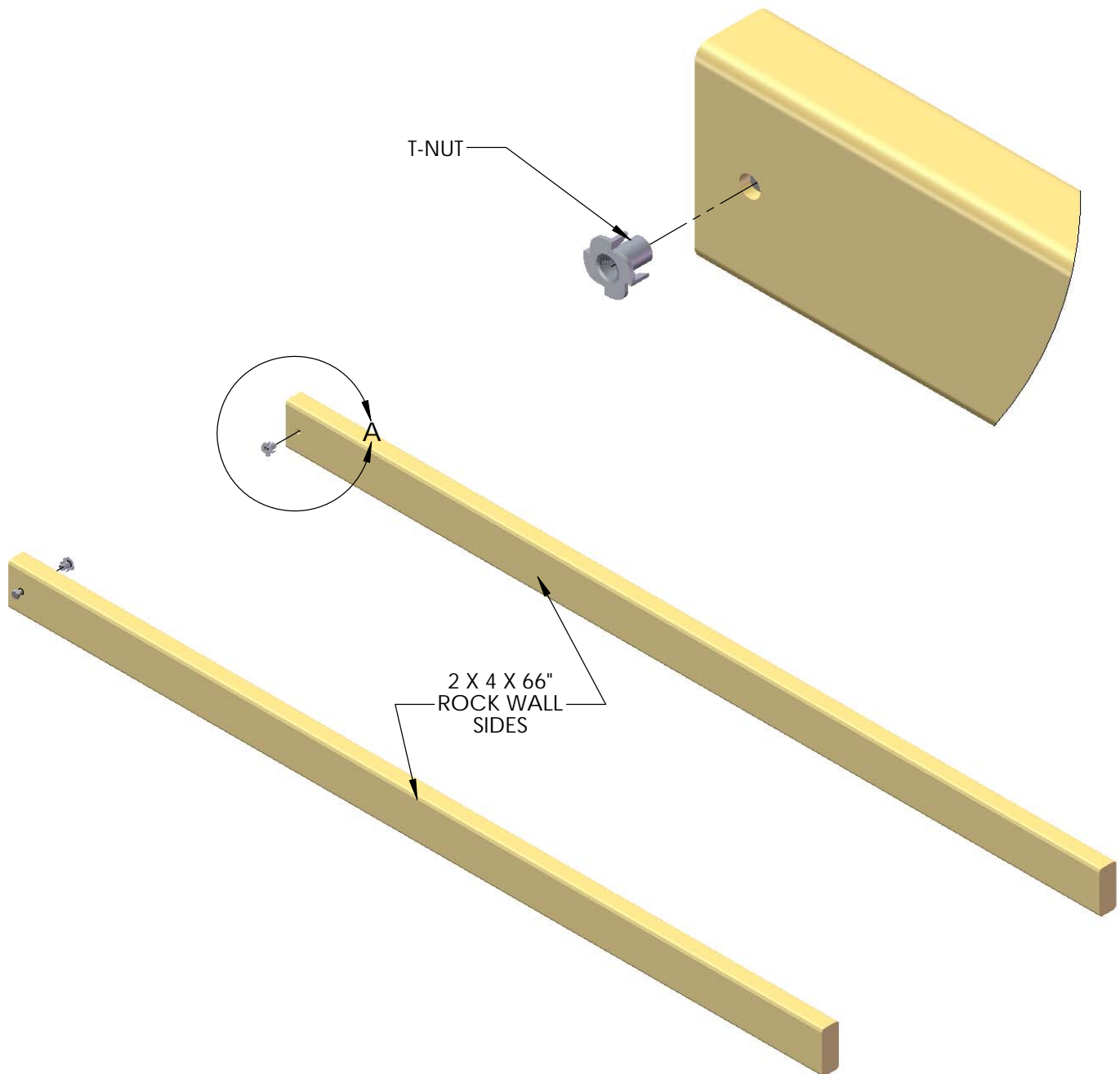

STEP 23: ROCK WALL

- 1: FIND ELEVEN 5/4 X 6 X 23-7/8" ROCK WALL BOARDS, AND ONE 5/4 X 6 X 23-7/8" BOTTOM ROCK WALL BOARD(1 HOLE).
- 2: STARTING FROM THE BOTTOM, PLACE THE ONE HOLE BOTTOM ROCK WALL BOARD ON TOP OF THE ROCK WALL SIDES AND ATTACH WITH TWO 2" WOOD SCREWS IN EACH SIDE.
- 3: CONTINUE UP THE ROCK WALL WITH THE REMAINING ROCK WALL BOARDS, FASTENING EACH BOARD WITH TWO 2" WOOD SCREWS ON EACH END.

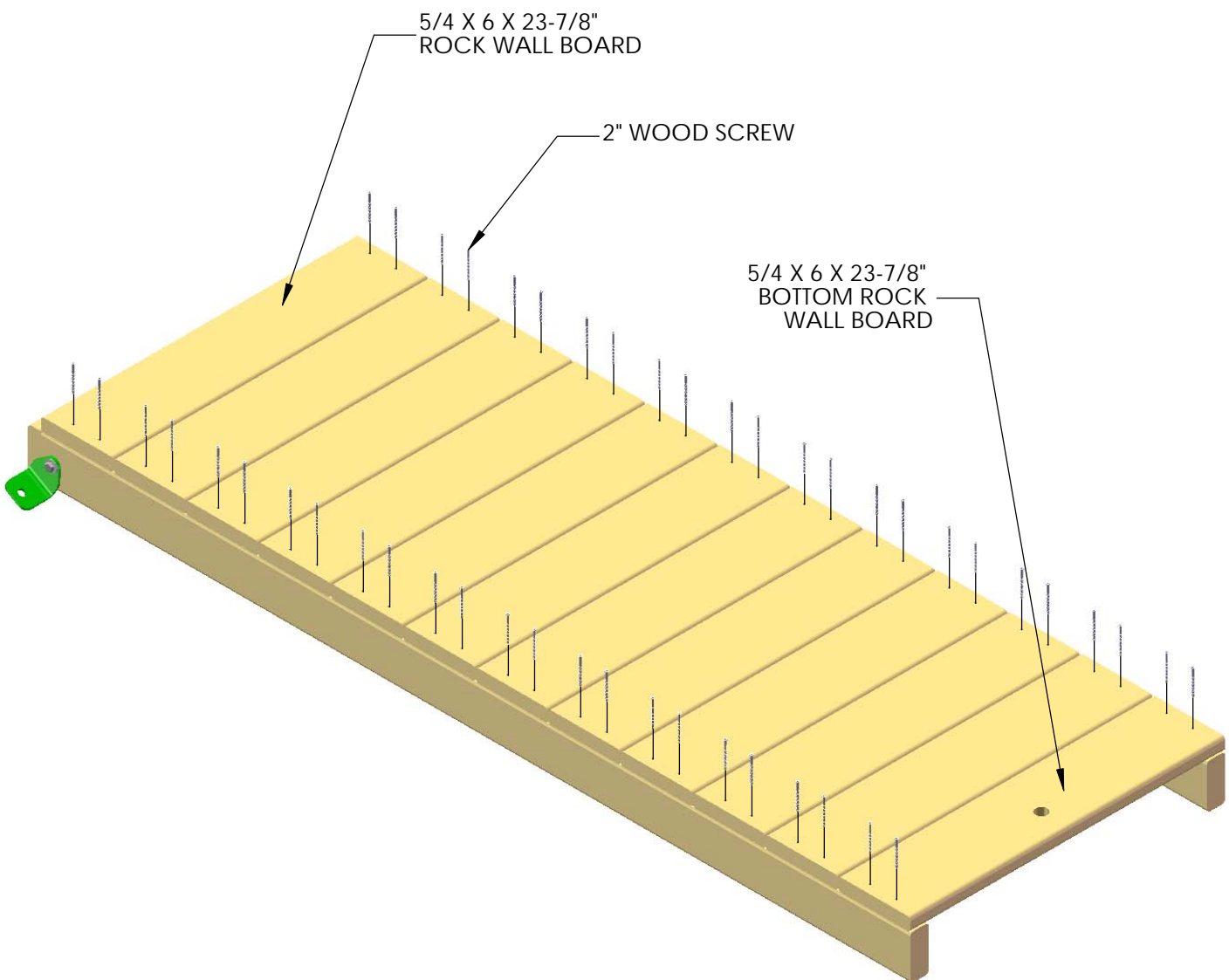

STEP 24: ROCK WALL

1: FASTEN THE 90° GREEN BRACKET TO THE ROCK WALL SIDES WITH 5/16" X 1-1/2" HEX BOLTS AND 5/16" WASHERS.

2: DO NOT FULLY TIGHTEN THE HEX BOLTS INTO THE T-NUTS AT THIS TIME.

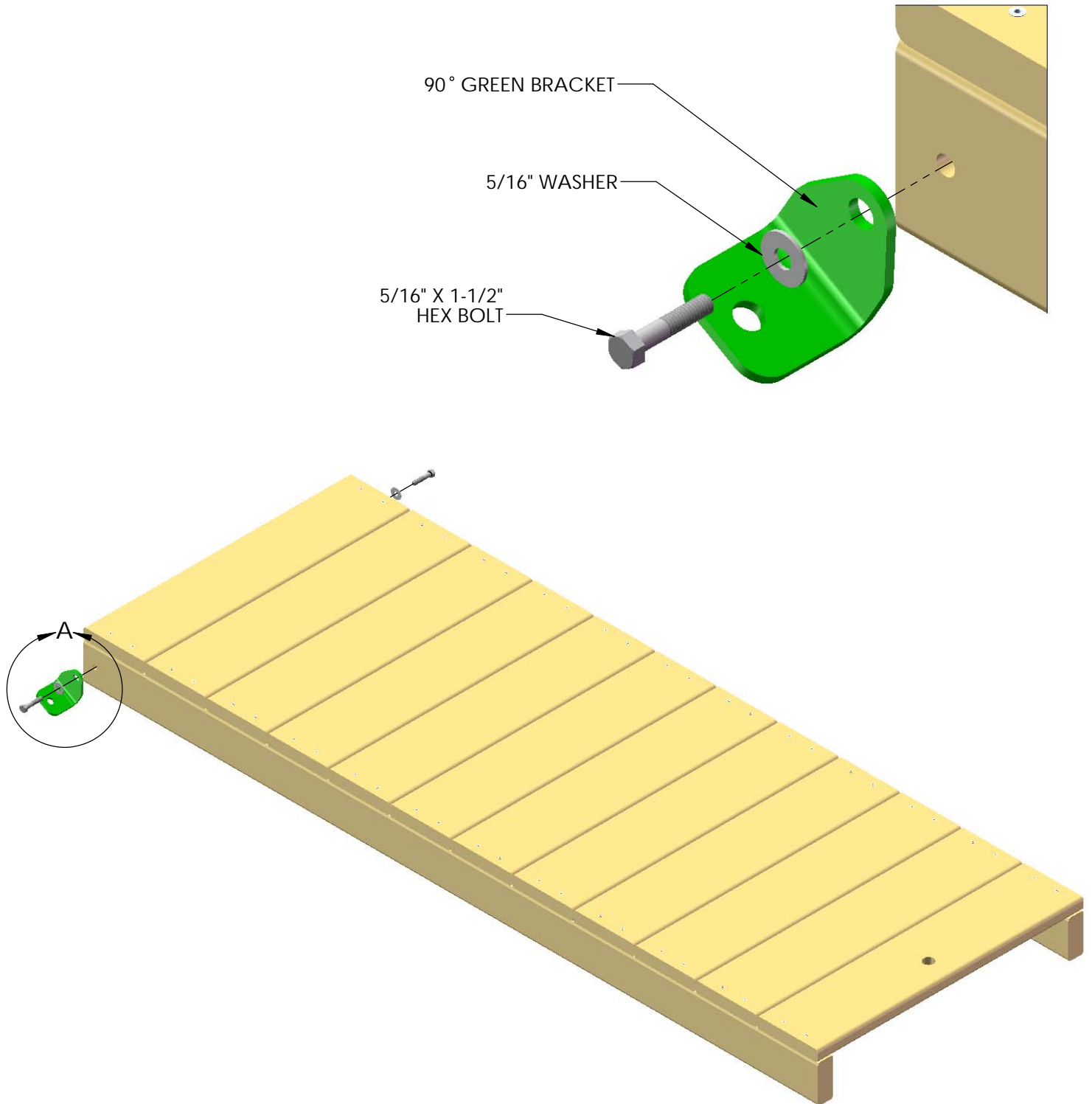

STEP 25: ROCK WALL

1: FIND TEN ROCKS AND TWENTY 1-1/4" PAN HEAD SCREWS.

2: MOUNT THE ROCKS IN A STAGGERED MANNER ON THE ROCK WALL BOARDS. TWO PAN HEAD SCREWS WILL SECURE EACH ROCK TO THE WALL.

NOTE: THE IMAGE SHOWN BELOW IS A GENERIC ARRANGEMENT OF ROCKS ON THE ROCK WALL. YOUR ACTUAL CONFIGURATION MAY BE DIFFERENT THAT WHAT YOU SEE BELOW. ROCKS CAN BE ARRANGED IN ANY PATTERN AS LONG AS THEY WILL ALLOW PROPER ACCESS TO THE FORT. BE CREATIVE!

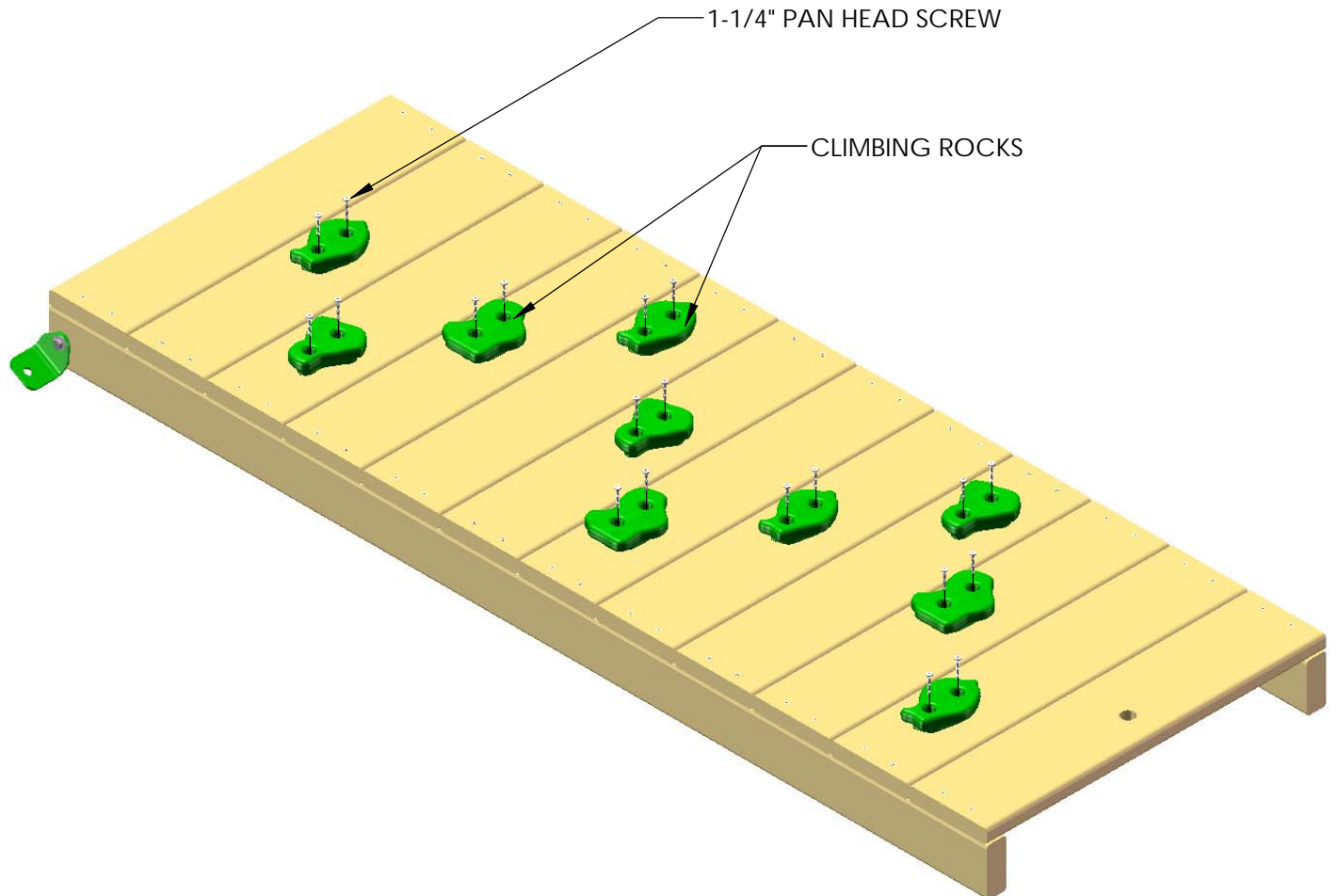

3: PLACE THE 5/4 X 3 X 23-7/8" ROCK WALL TOP CAP ON TOP OF THE ROCK WALL SIDES. FASTEN THE ROCK WALL TOP CAP TO THE ROCK WALL SIDES WITH 2" WOOD SCREWS.

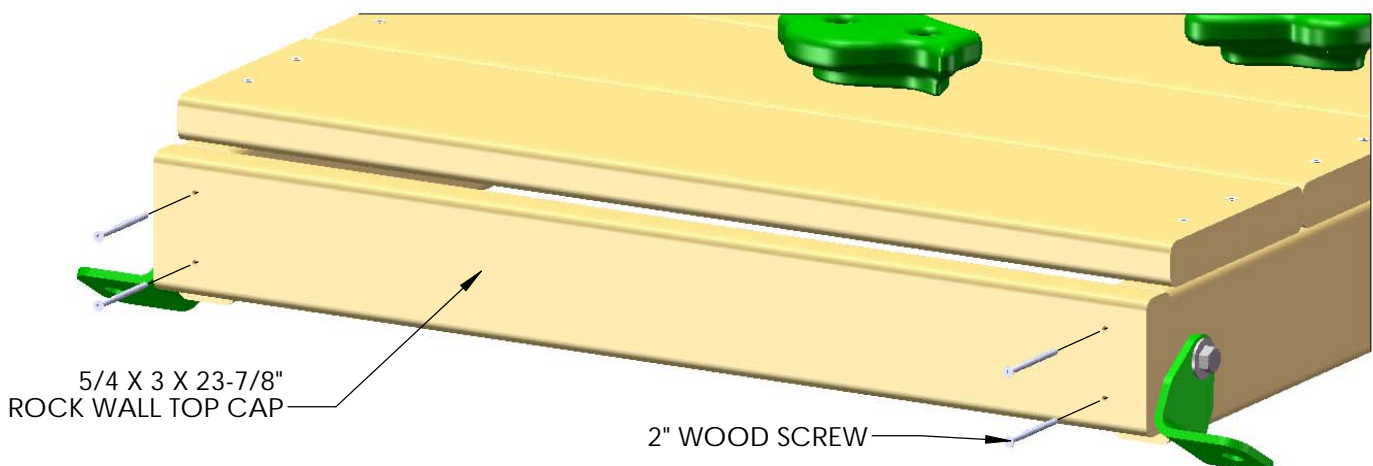

STEP 26: ROCK WALL

- 1: PLACE THE ROCK WALL INTO POSITION ON THE FORT AS SHOWN BELOW. USING THE 90 ° BRACKETS AS A TEMPLATE; DRILL A 3/8" HOLE THROUGH THE BOTTOM PANEL BOARD.
- 2: FROM THE UNDERSIDE OF THE DECK INSERT A T-NUT INTO THE BACKSIDE OF THE 3/8" HOLES ON THE BOTTOM PANEL BOARD.
- 3: ATTACH THE ROCK WALL WITH 5/16 X 1-1/2" BOLTS AND 5/16" WASHERS.
- 4: WHEN THE BRACKETS ARE SECURE, AND THE ROCK WALL IS IN ITS FINAL POSITION; TIGHTEN THE 5/16 X 1-1/2" BOLTS ON THE ROCK WALL SIDES.
- 5: THREAD ROPE THROUGH HOLE ABOVE THE ROCK WALL. TIE A KNOT ON THE INSIDE OF THE TOP SIDE RAIL.
- 6: THREAD THE OPPOSITE END OF THE ROPE THROUGH THE HOLE IN THE BOTTOM ROCK WALL BOARD, PULL TIGHT AND TIE A KNOT BEHIND THE ROCK WALL MAKING SURE THE ROPE IS TIGHT.

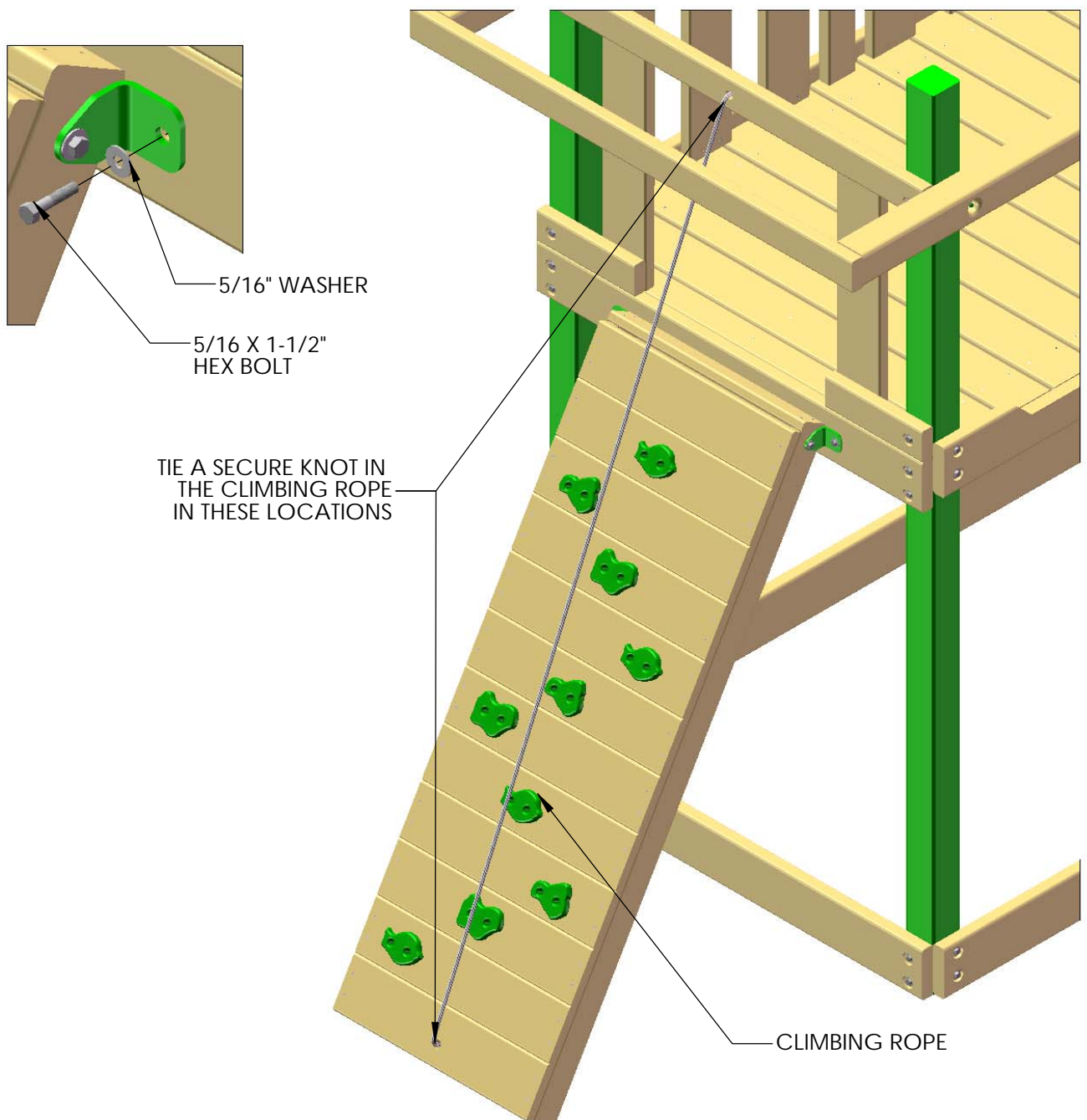

STEP 27: CORNER SEATS

- 1: FIND THE TWO 2 X 6 X 24-3/4" CORNER SEATS.
- 2: PLACE ON TOP OF THE SANDBOX BOARDS, EDGES FLUSH TO THE OUTSIDE OF THE SANDBOX BOARD, ON THE ROCK WALL SIDE OF THE UNIT.
- 3: ATTACH WITH TWO 2-1/2" WOOD SCREWS ON EACH END OF THE SEATS.

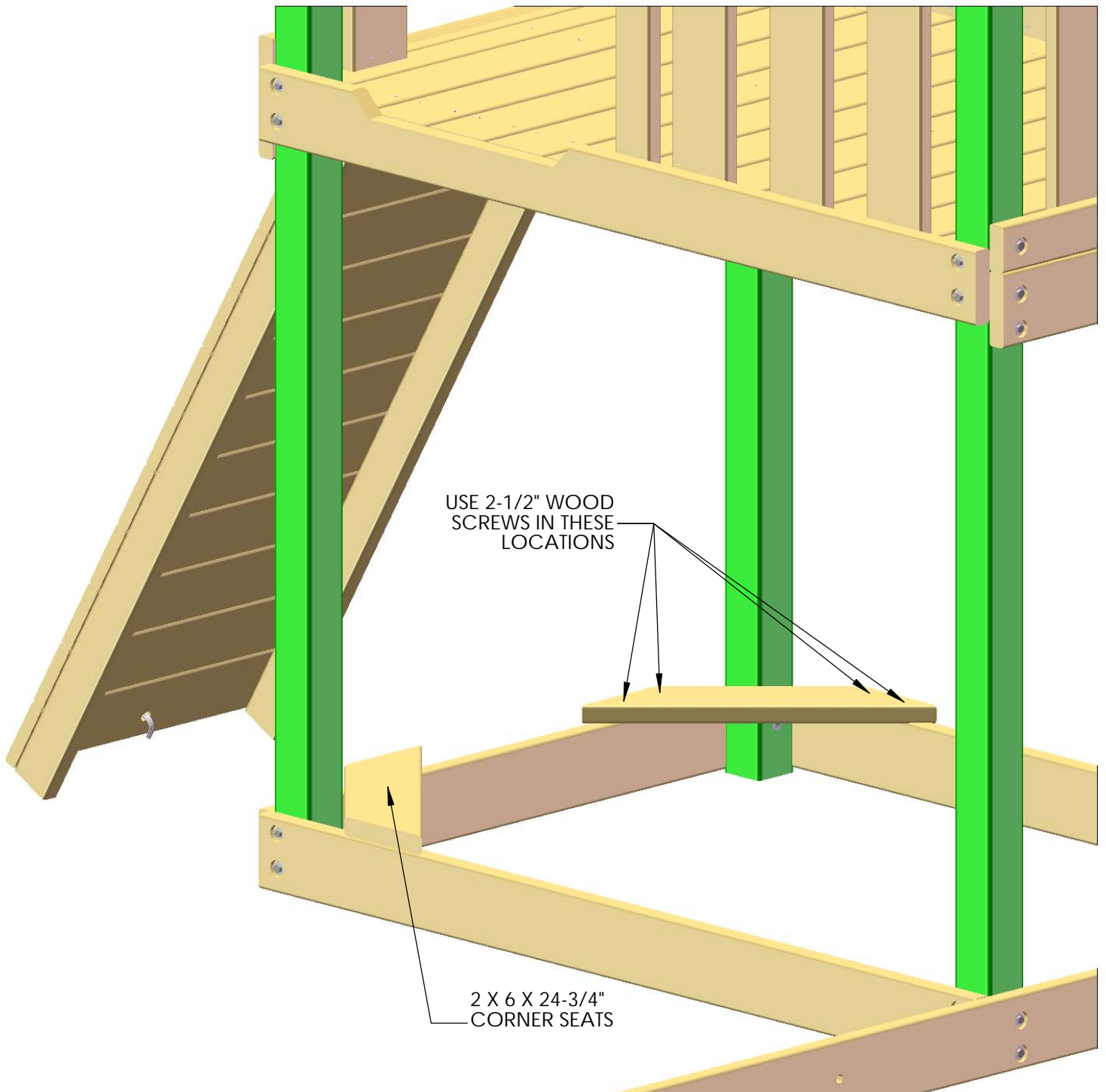

STEP 28: PICNIC TABLE ASSEMBLY

- 1: FIND THE 2 X 4 X 30-1/2" PICNIC TABLE FRAME, AND ONE 2 X 4 X 15-1/2" PICNIC TABLE SUPPORT.
- 2: PLACE PICNIC TABLE TOP SUPPORT ON TOP OF THE PICNIC TABLE FRAME, PERPENDICULAR. ATTACH WITH THREE 2-1/2" WOOD SCREWS.
- 3: ATTACH ASSEMBLY TO CORNER POST WITH THREE 2-1/2" WOOD SCREWS FROM THE OUTSIDE.
- 4: ATTACH ASSEMBLY TO SANDBOX BOARD WITH TWO 2-1/2" WOOD SCREWS FROM THE INSIDE.

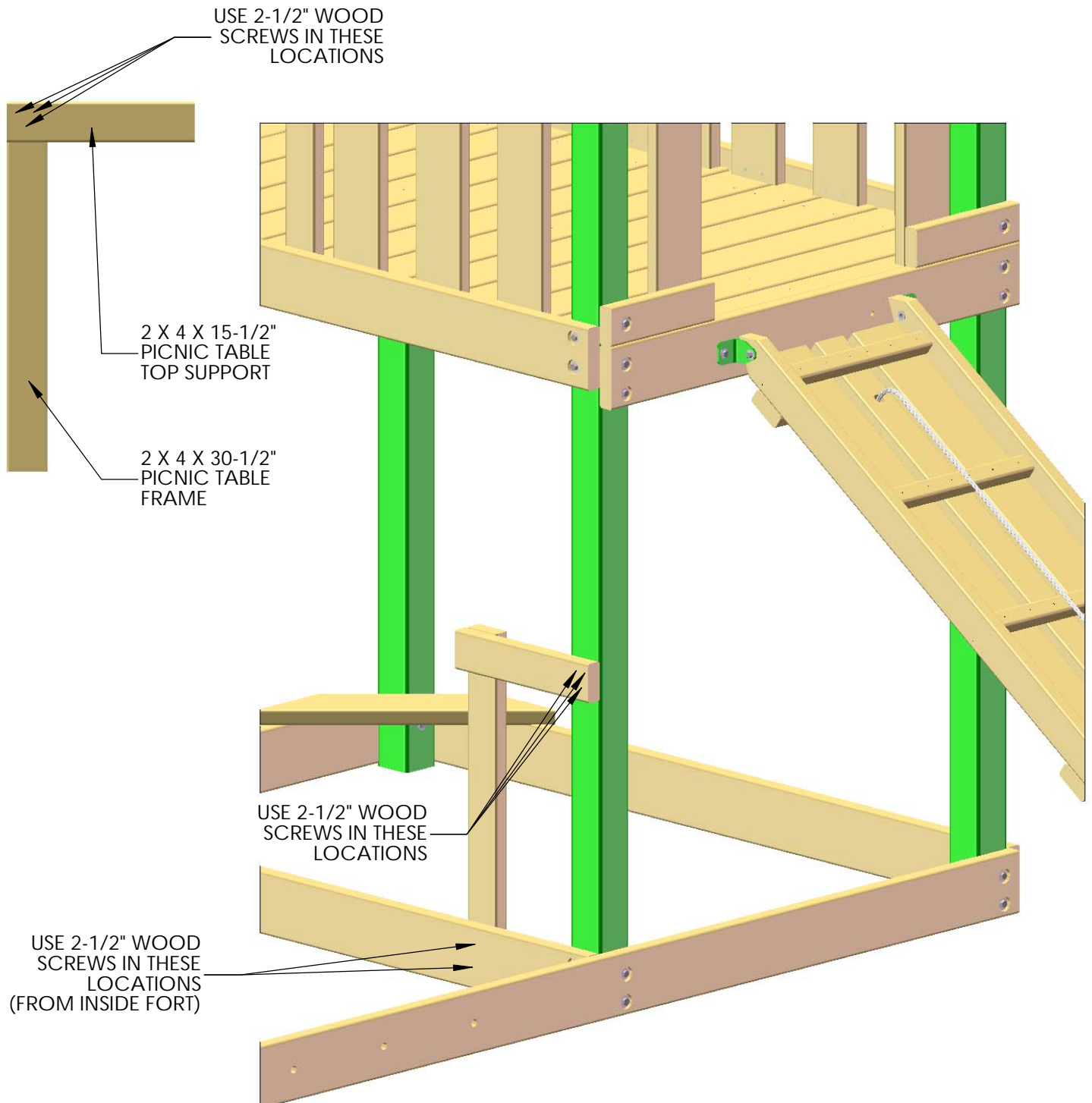

STEP 29: SAFETY BOARD

- 1: FIND THE 2 X 4 X 70" SAFETY BOARD.
- 2: MEASURE AND MARK 30-1/2" FROM THE GROUND UP ON THE TWO CORNER POSTS.
- 3: ATTACH THE SAFETY BOARD SO THAT THE TOP IS AT 30-1/2" FROM THE GROUND. USE TWO 5/16 X 3-1/2" LAG SCREWS, AND 5/16" WASHERS.

NOTE: IF USING A RATCHET, TAP THE LAG SCREWS WITH A HAMMER TO START.

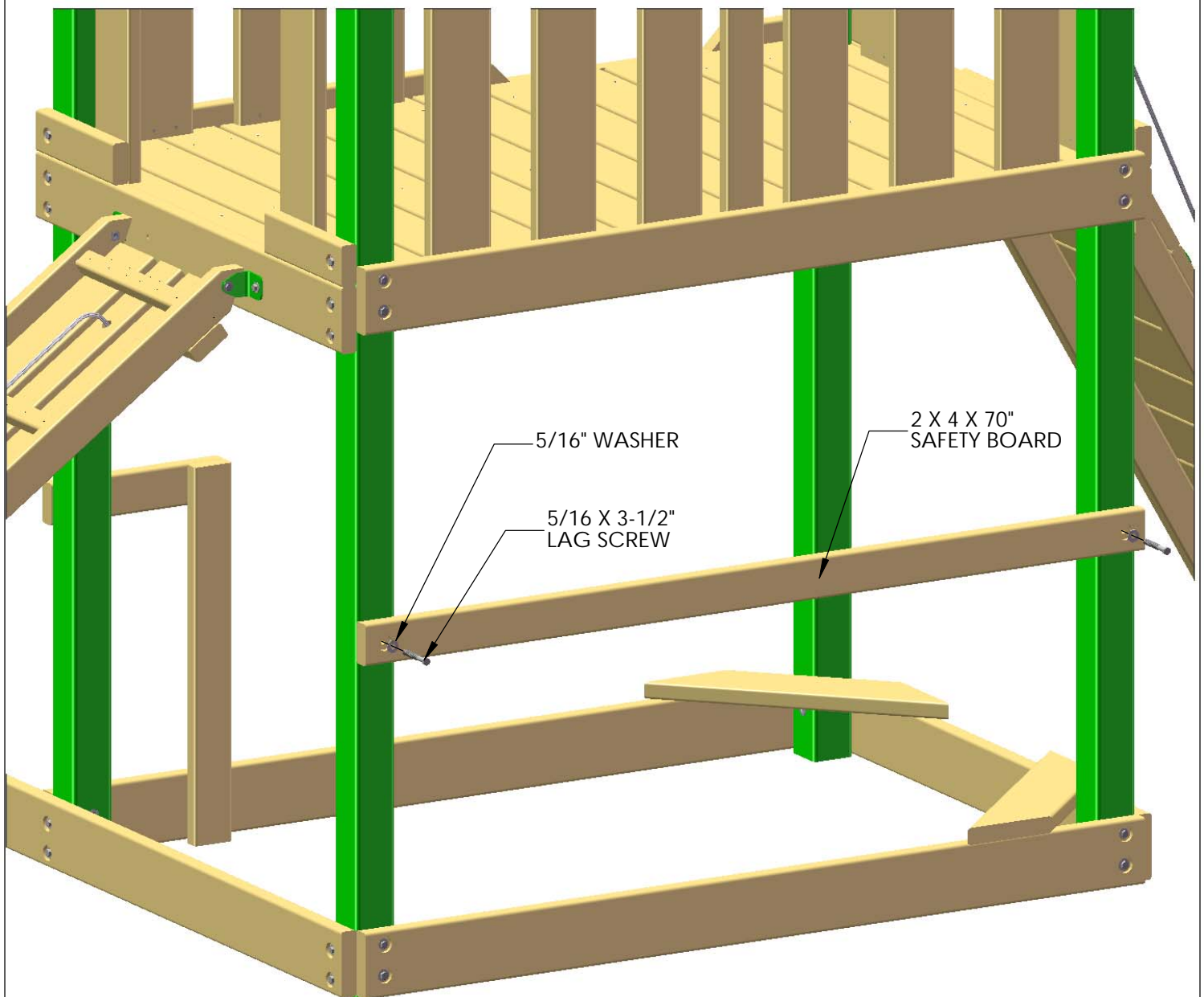

STEP 30: PICNIC TABLE FRAME

1: FIND THE 2 X 4 X 30-1/2" PICNIC TABLE FRAME BOARD.

2: MEASURE 15-1/2" FROM THE OUTSIDE OF THE CORNER POST AND MARK ON SAFETY BOARD AND SANDBOX BOARD.

ATTACH THE PICNIC TABLE FRAME BOARD TO THE INSIDE OF THE FORT WITH THREE 2-1/2" WOOD SCREWS AT THE TOP, AND TWO 2-1/2" WOOD SCREWS AT THE BOTTOM.

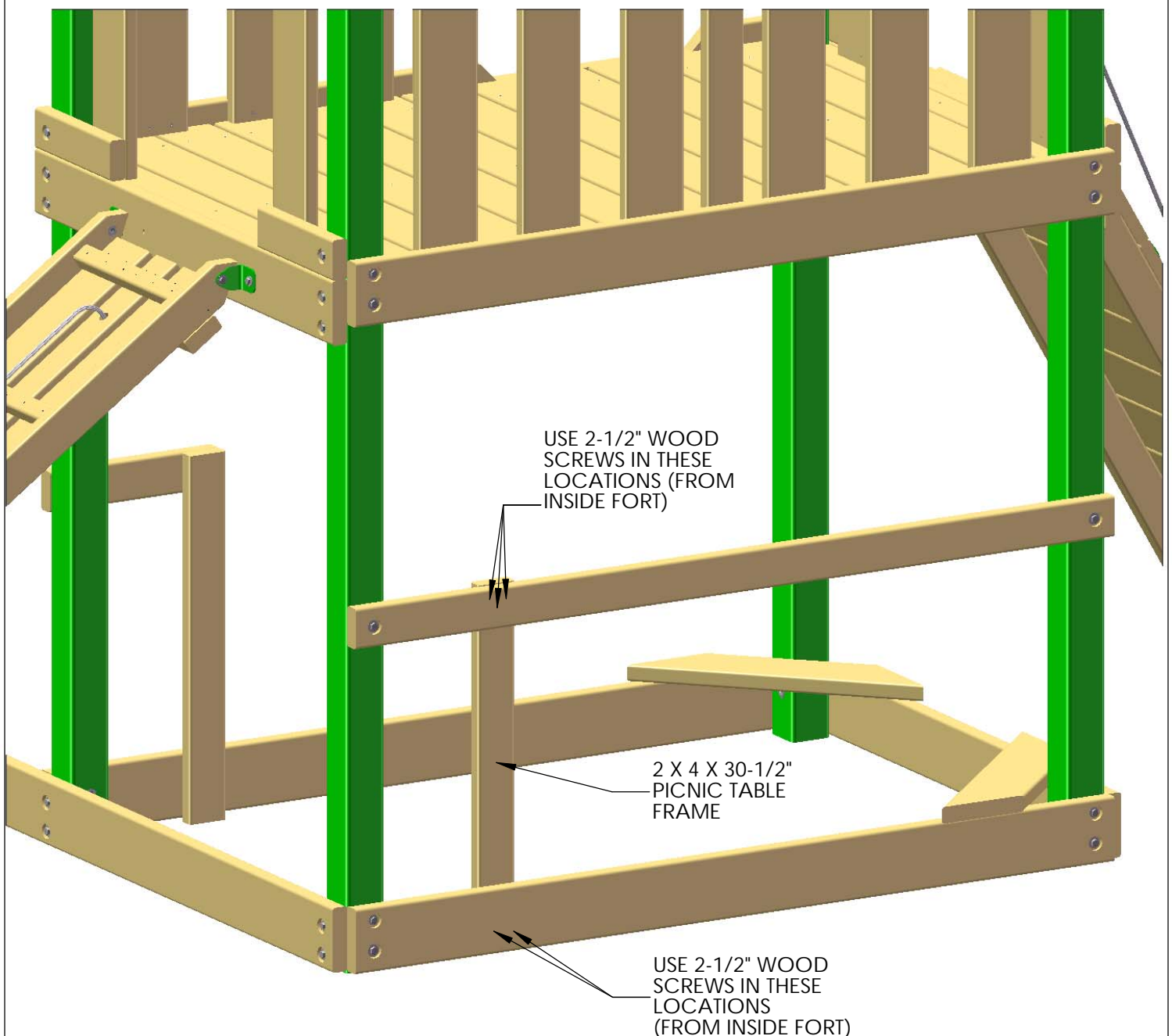

STEP 31: PICNIC TABLE SEAT SUPPORTS

- 1: FIND THE 2 X 4 X 21" PICNIC TABLE SEAT SUPPORT.
- 2: MEASURE 18" FROM THE GROUND AND MARK ON THE CORNER POST AND PICNIC TABLE FRAME.
- 3: ATTACH THE PICNIC TABLE SEAT TO THE OUTSIDE OF THE FORT SO THAT THE TOP IS 18" FROM THE GROUND. USE THREE 2-1/2" WOOD SCREWS AT EACH END.

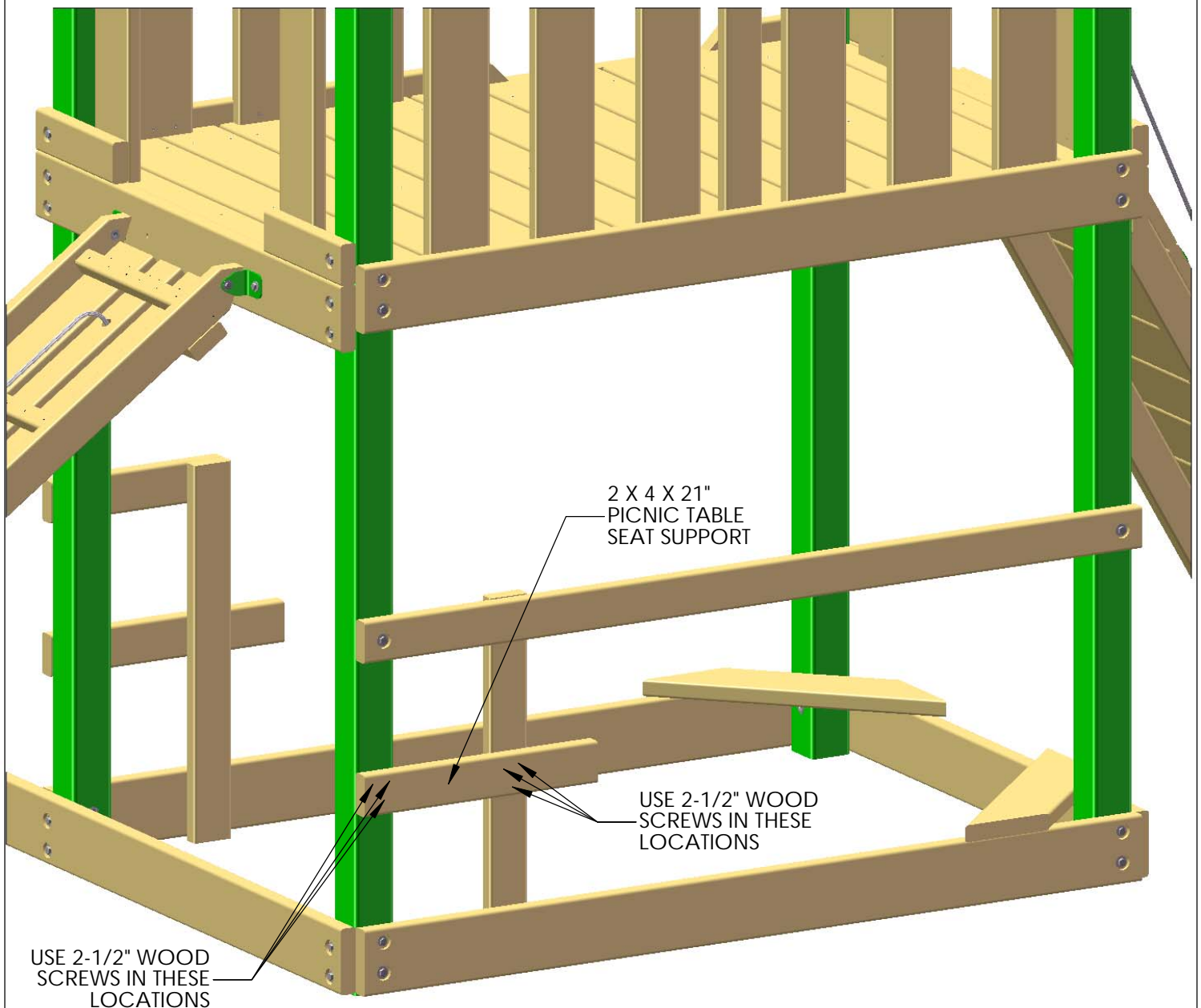

STEP 32: PICNIC TABLE SEAT

1: FIND THE 2 X 6 X 51" PICNIC TABLE SEAT.

2: ATTACH THE PICNIC TABLE SEAT TO THE SEAT SUPPORT. USE TWO 2-1/2" WOOD SCREWS AT EACH END.

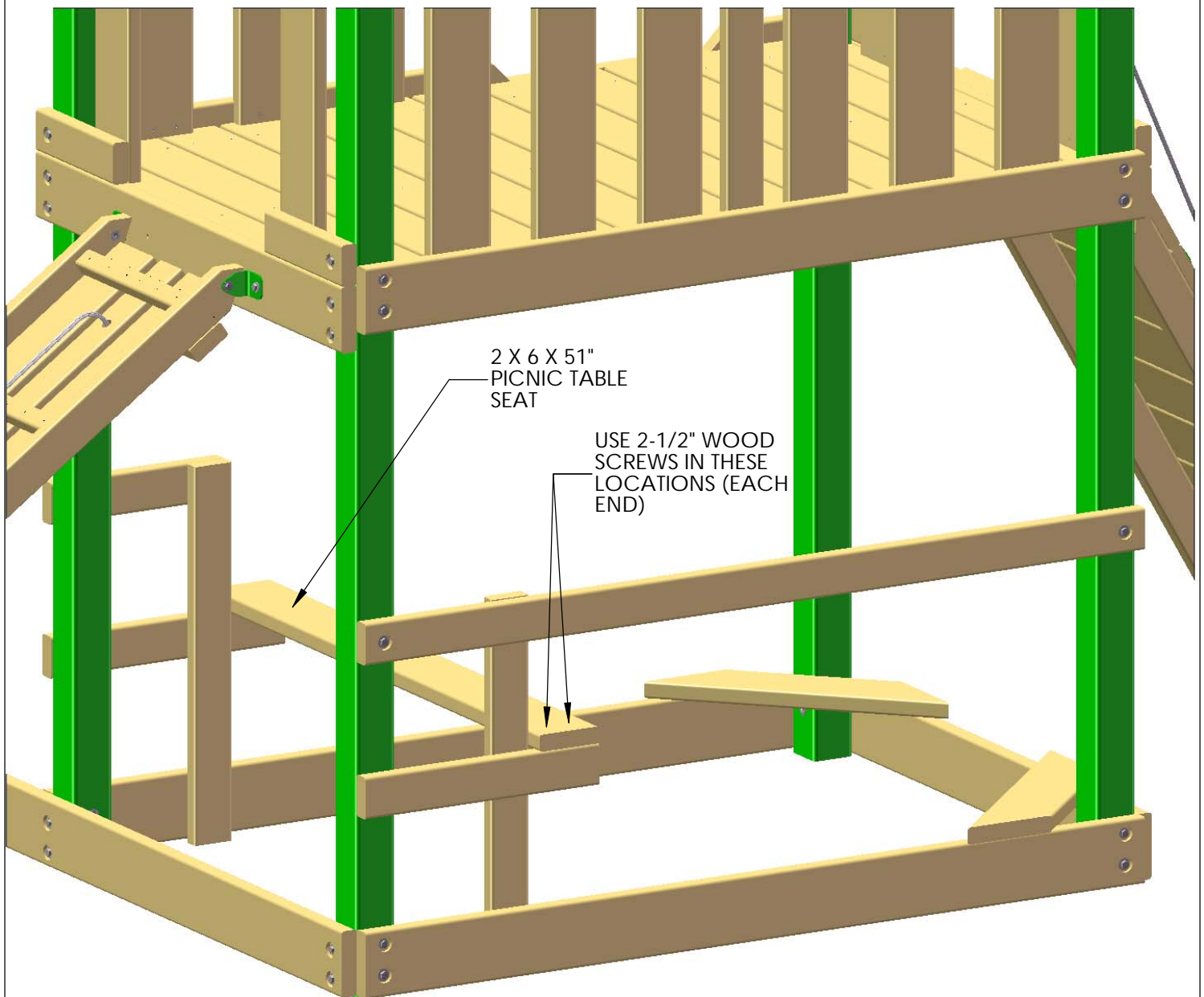

STEP 33: PICNIC TABLE TOP

1: FIND THE 5/4 X 6 X 51" PICNIC TABLE TOP.

2: ATTACH THE PICNIC TABLE TOP TO THE PICNIC TABLE SUPPORT AND THE SAFETY BOARD. USE TWO 2" WOOD SCREWS AT EACH END.

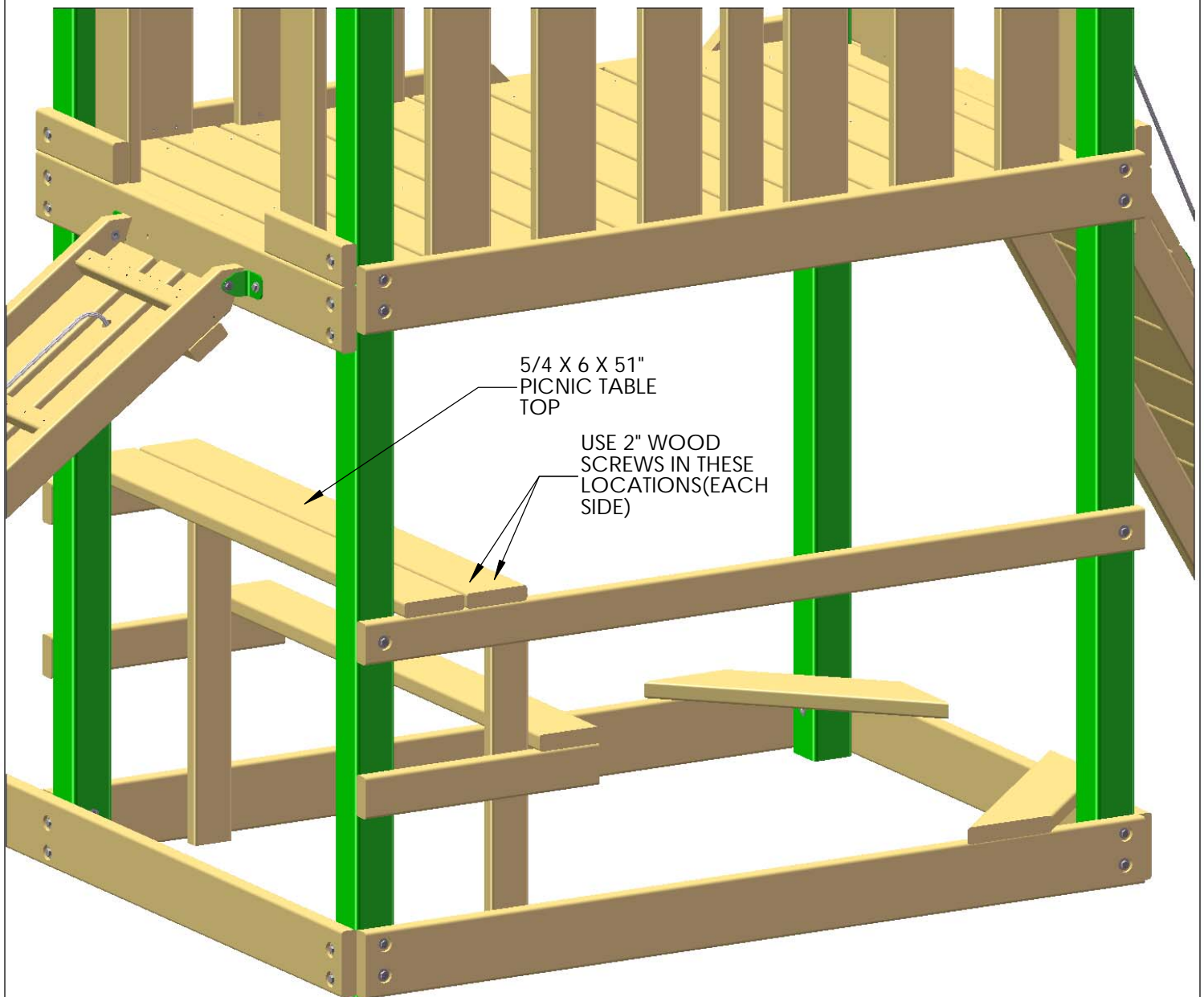

STEP 34: MOUNTING THE SLIDE

- 1: POSITION THE SLIDE SO THAT IT RESTS FLUSH ON THE DECK BOARDS IN THE FRONT OPENING.
- 2: FASTEN TO THE FORT WITH 1-1/4" WOOD SCREWS

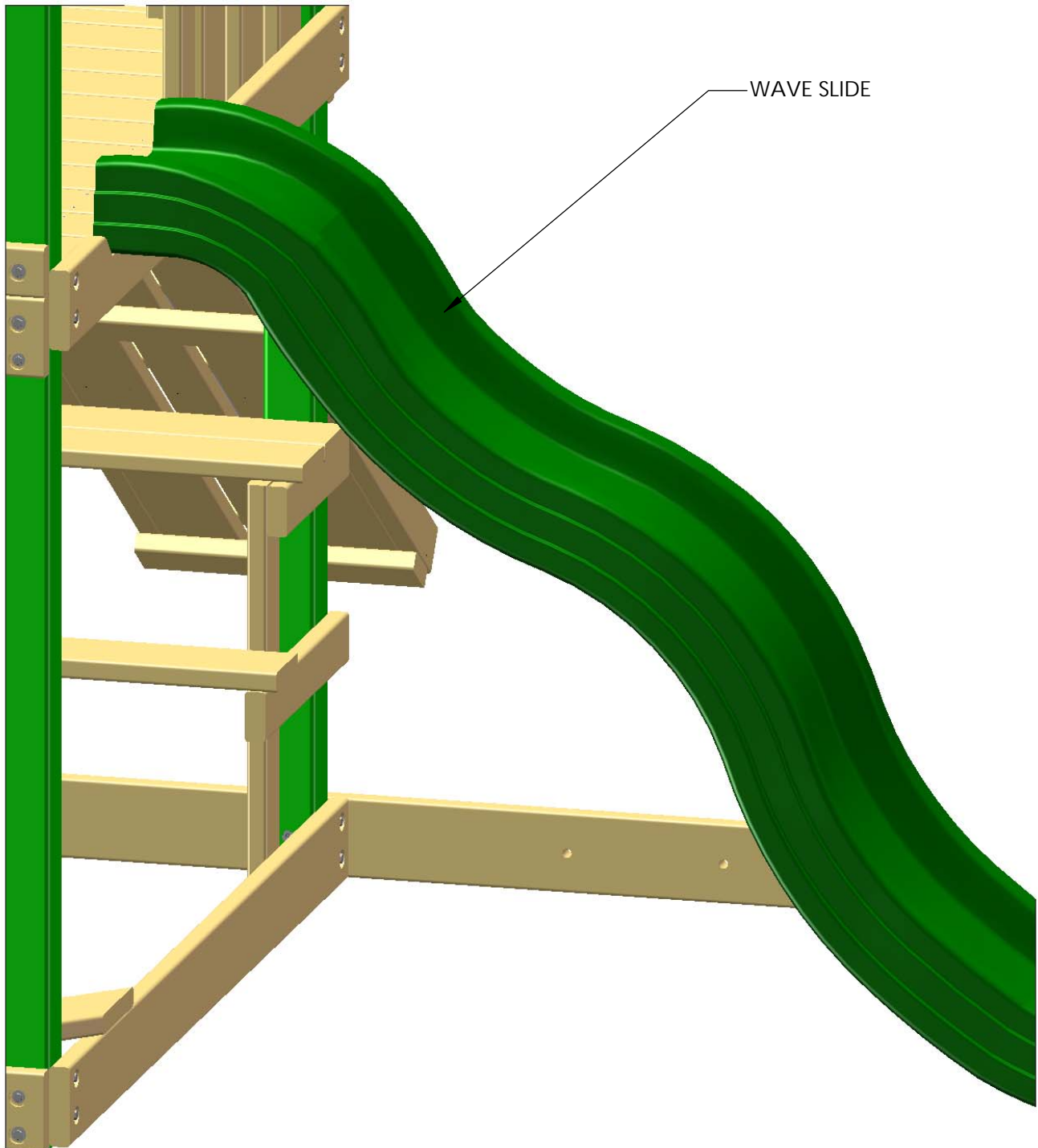

STEP 35: TARP

- 1: LAY TARP CENTERED ACROSS TARP BOARDS MAKING SURE THE HEM SIDE IS DOWN.
- 2: BEGINNING WITH THE FRONT RIGHT SIDE CORNER, ATTACH THROUGH GROMMET WITH ONE 1-1/4" PAN HEAD SCREW.
- 3: PULL THE TARP TIGHT AND SCREW IN THE LEFT FRONT SIDE CORNER.
- 4: ALTERNATE SIDE TO SIDE, KEEPING THE TARP TIGHT AND WRINKLE-FREE WHILE ATTACHING TARP THROUGH THE REST OF THE GROMMETS.

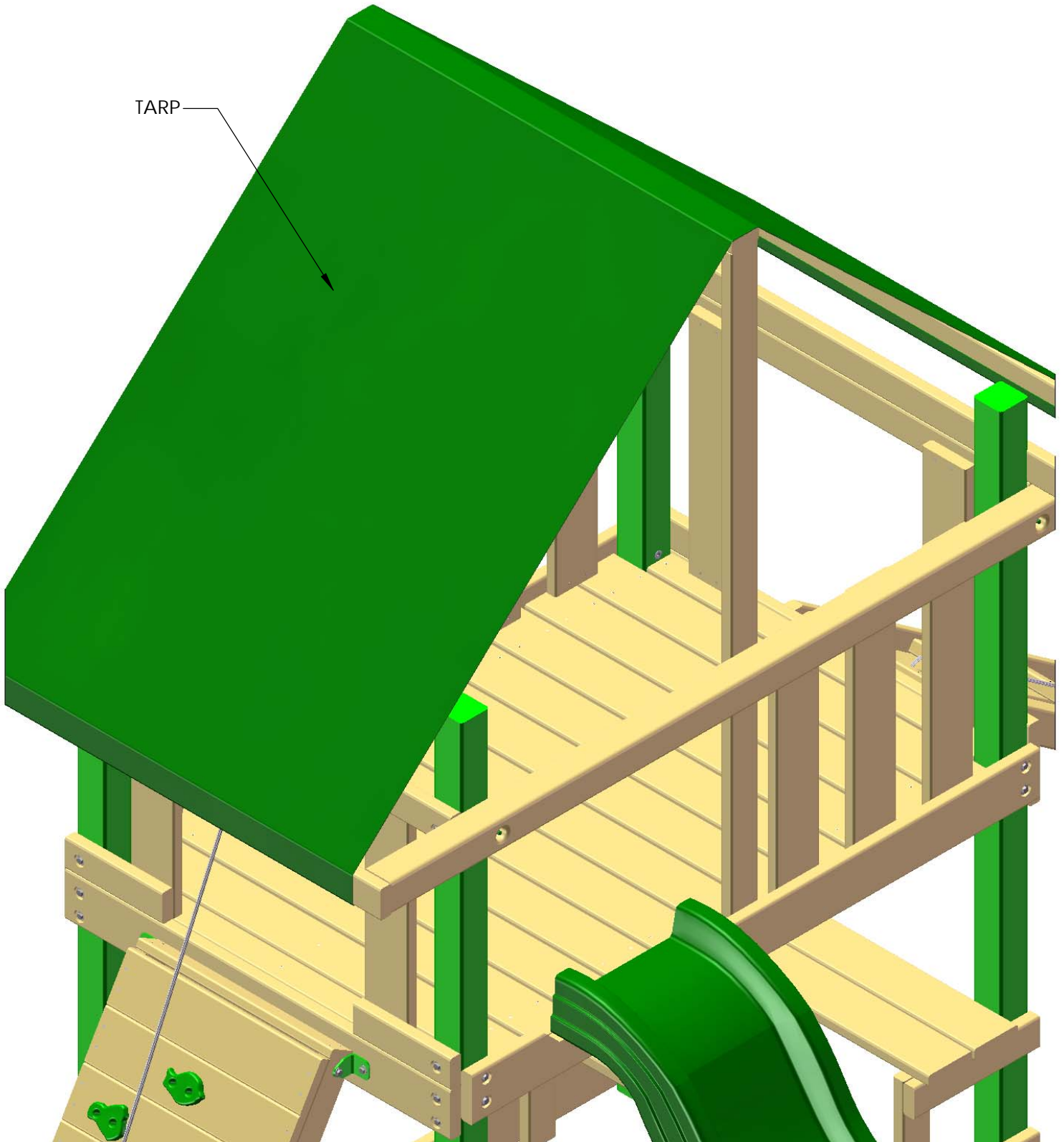

STEP 36: SWING BEAM PLATE

1: PLACE THE SWING BEAM PLATE ON TOP OF THE SWING BEAM SUPPORT, LINING UP THE PILOT HOLES.

2: FASTEN THE SWING BEAM PLATE TO THE SWING BEAM SUPPORT USING 3-1/2" CARRIAGE BOLTS WITH 1/2" WASHERS ON TOP, AND 3/8" LOCK NUTS WITH 3/8" WASHERS FROM UNDERNEATH, IN THE COUNTER-SUNK HOLES OF THE SWING BEAM SUPPORT. USE BOLT CAPS TO COVER ANY EXPOSED THREADS.

3: LEAVE THE MIDDLE HOLE EMPTY, IT WILL BE USED LATER.

4: USE VICE GRIPS TO HOLD THE CARRIAGE BOLTS IN PLACE WHEN INSTALLING.

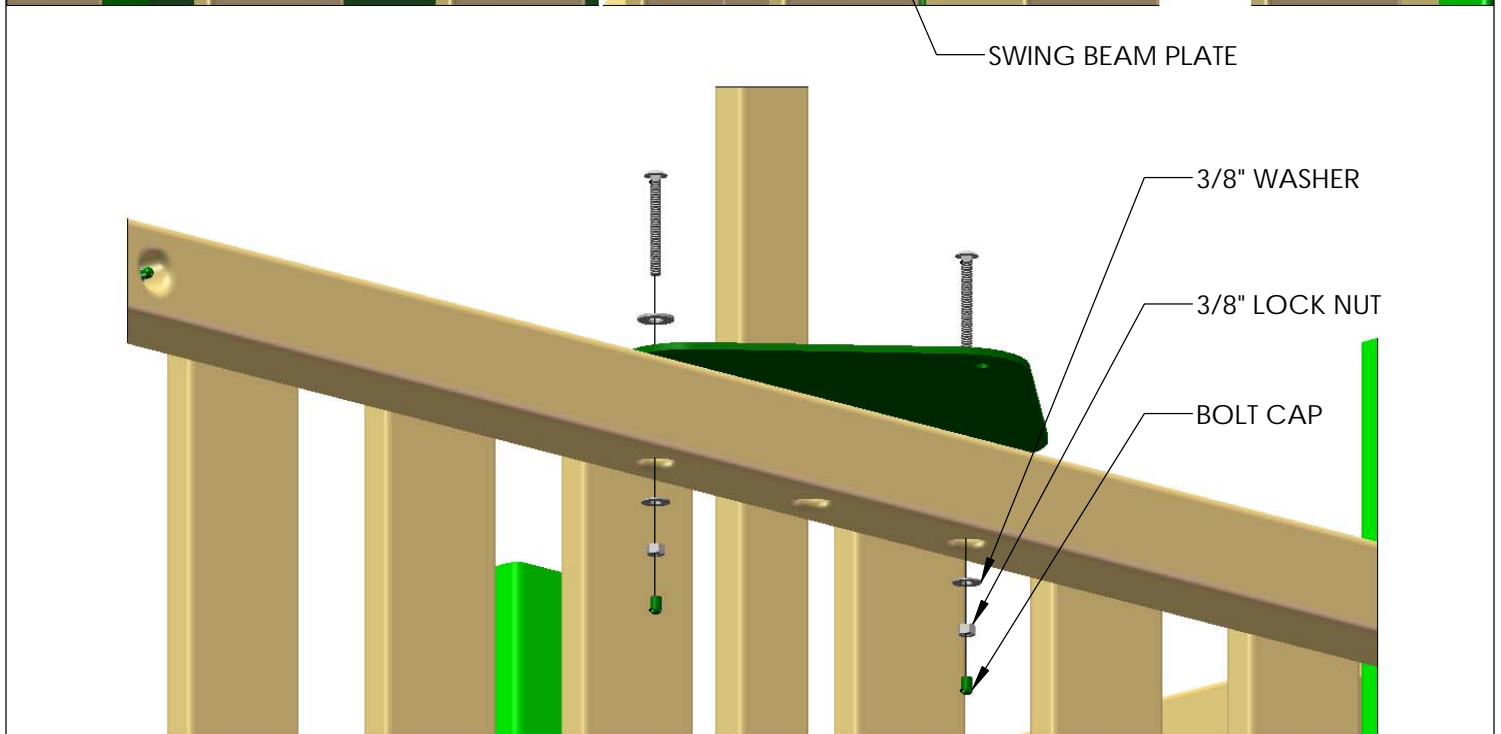
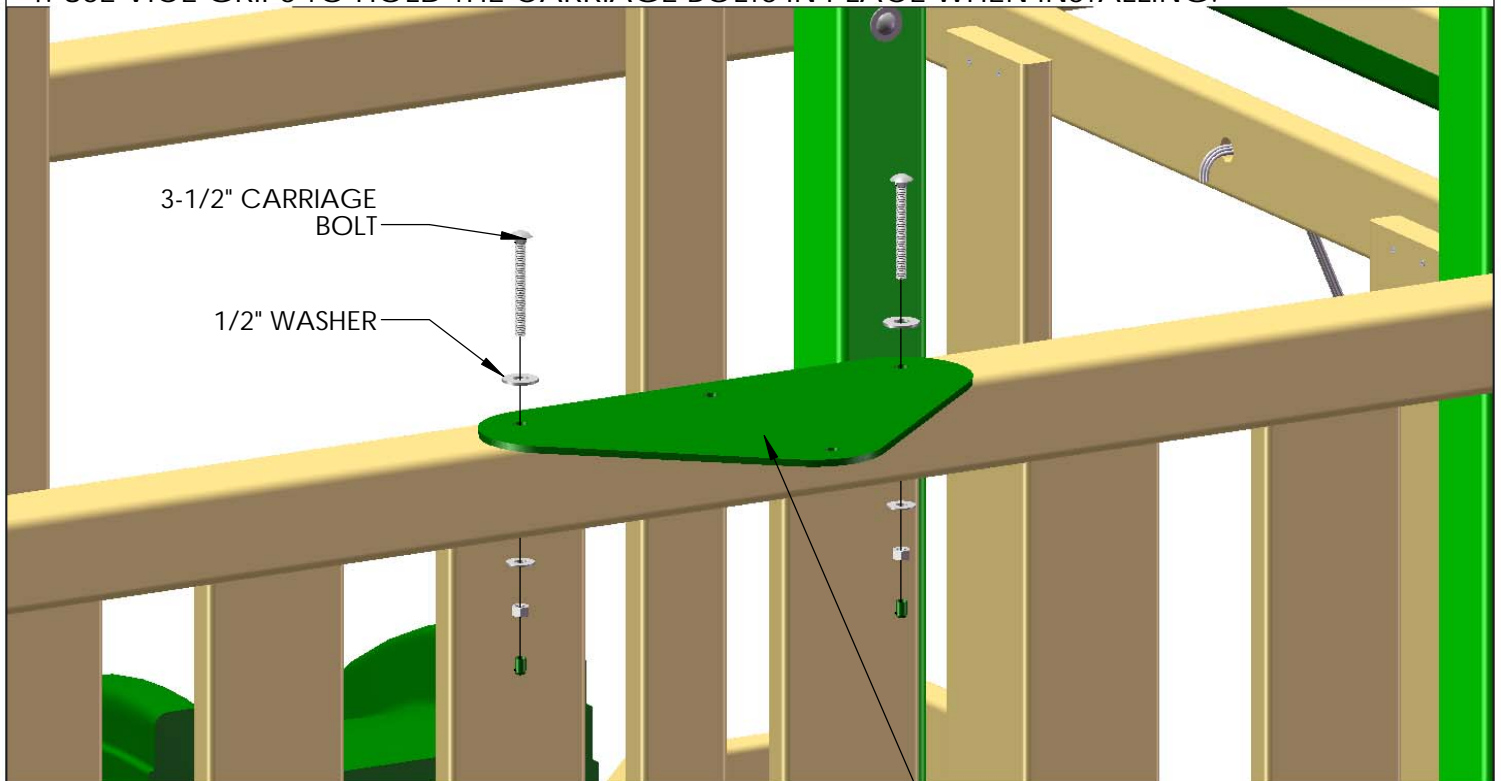

STEP 37: IRON DUCTILES

- 1: LINE UP THE HOLES OF THE IRON DUCTILES WITH THE HOLES IN THE SWINGBEAM.
- 2: FASTEN THE SWING HANGER TO THE SWING BEAM USING 6-1/2" CARRIAGE BOLTS WITH 1/2" WASHERS, AND 3/8" WASHERS WITH 3/8" LOCK NUTS.
- 3: PLACE BOLT CAPS OVER EXPOSED THREADS.
- 4: USE VICE GRIPS TO HOLD CARRIAGE BOLTS IN PLACE WHEN INSTALLING.

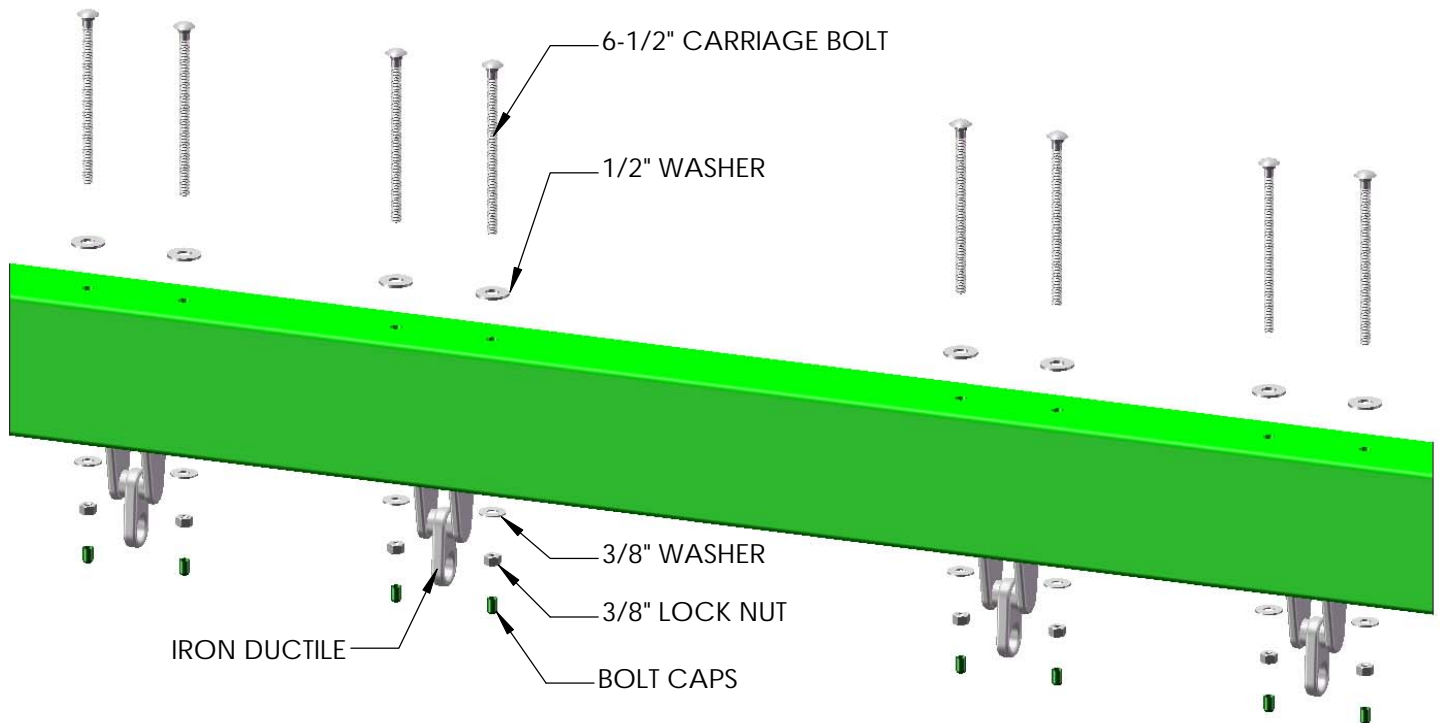

STEP 38: ATTACH SWING LEGS TO BRACKET

1: PLACE THE 4 X 4 X 96" SWING LEGS FLUSH TO THE TOP OF THE SWING LEG BRACKET.

2: FASTEN THE SWING LEGS TO THE SWING LEG BRACKET WITH 3/8 X 3-1/2" LAG SCREWS AND 3/8" WASHERS.

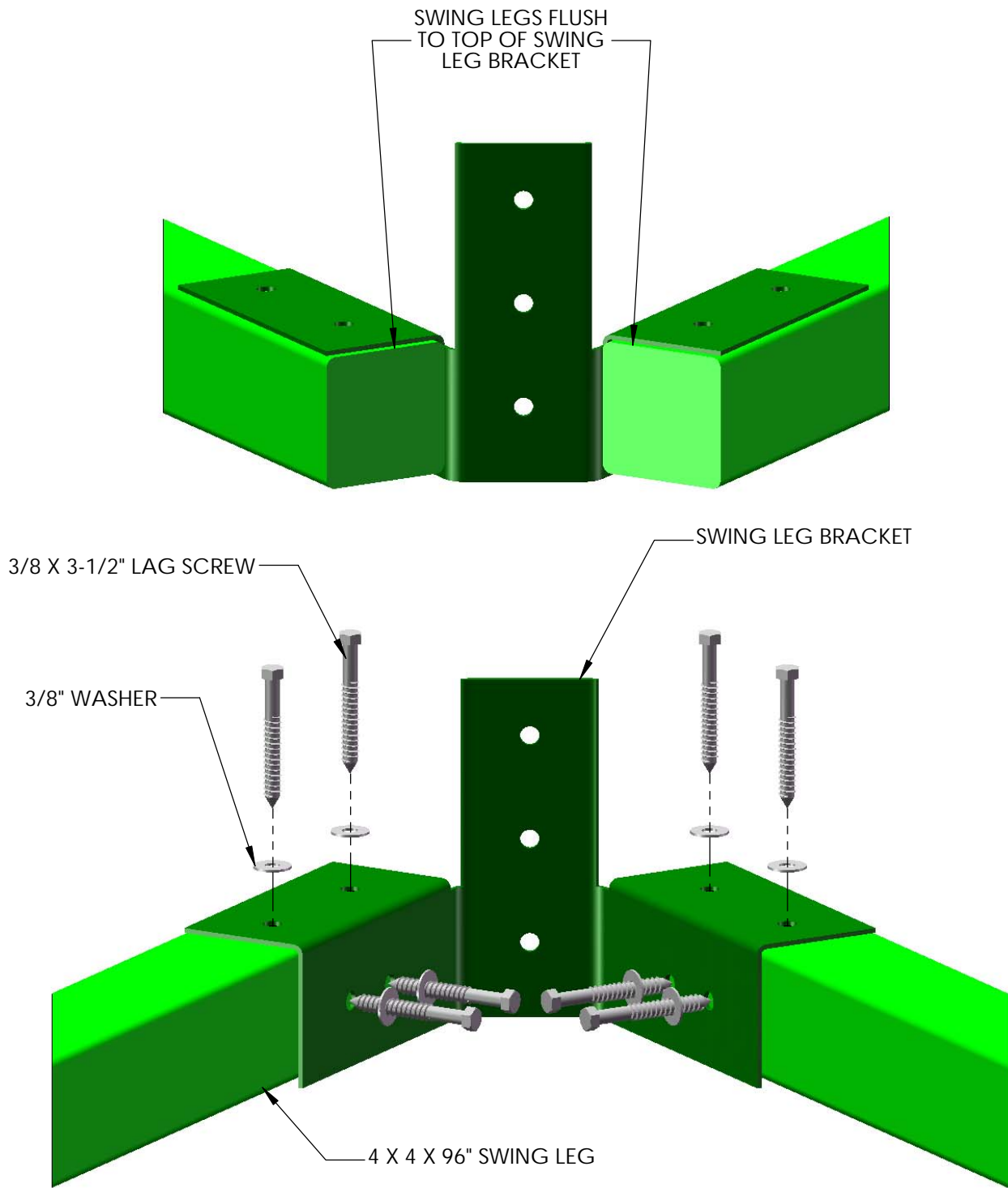

STEP 39: MOUNT SWING BEAM TO SWING BEAM LEGS

- 1: FASTEN THE SWING BEAM TO THE SWING BEAM BRACKET USING 6-1/2" CARRIAGE BOLTS WITH 1/2" WASHERS ON TOP OF THE SWING BEAM, AND 3/8" LOCK NUTS WITH 3/8" WASHERS FROM UNDERNEATH.
- 2: USE A 3/8 X 3-1/2" LAG SCREW WITH 3/8" WASHER FOR THE HOLE IN THE CENTER OF THE SWING BEAM BRACKET.
- 3: PLACE A BOLT CAP OVER ANY EXPOSED THREADS.
- 4: USE VICE GRIPS TO HOLD CARRIAGE BOLTS IN PLACE WHEN INSTALLING.

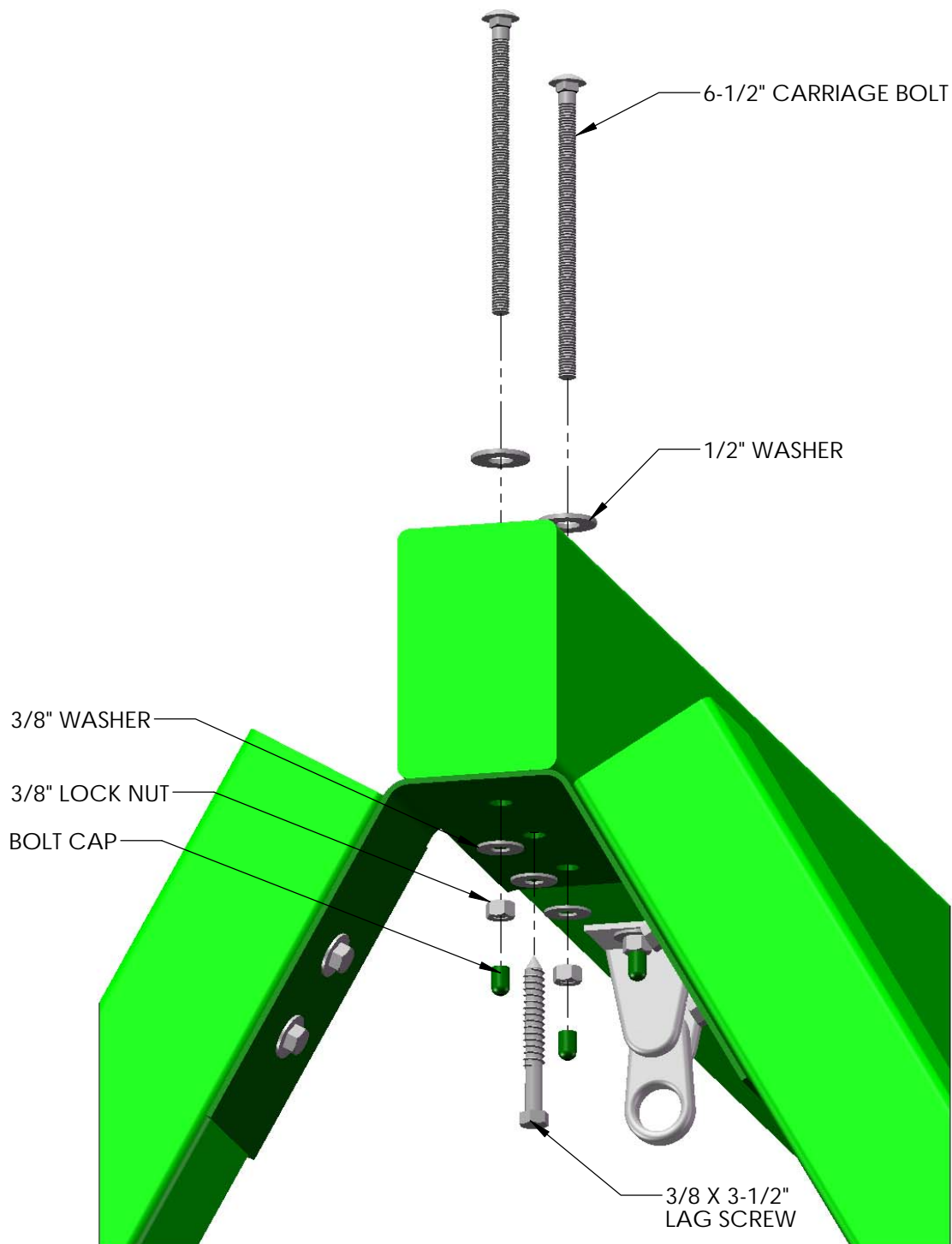

STEP 40: REST SWING BEAM ON FORT

AN EXTRA PERSON IS NEEDED FOR THIS STEP

1: SIT THE SWING BEAM LEGS UPRIGHT.

2: LINE UP THE PRE-DRILLED HOLES, AND REST THE SWING BEAM ON TOP OF THE FORT AND THE SWING BEAM LEGS. MAKE SURE THAT YOU HAVE THE BEAM FACING THE RIGHT WAY.

IMPORTANT NOTE: THE LEGS ARE DESIGNED TO ACCOMODATE SWING BEAMS ON UNEVEN GROUND (DOWN SLOPE). THEY ARE LONGER THAN REQUIRED. IF YOUR GROUND IS RELATIVELY LEVEL, YOU MAY NEED TO EITHER A) SHORTEN THE END OF THE LEGS B) DIG IN BOTH LEGS WHERE THEY MEET THE GROUND, OR C) BEND THE LEGS OUT SLIGHTLY TO MATCH YOUR GRADE.

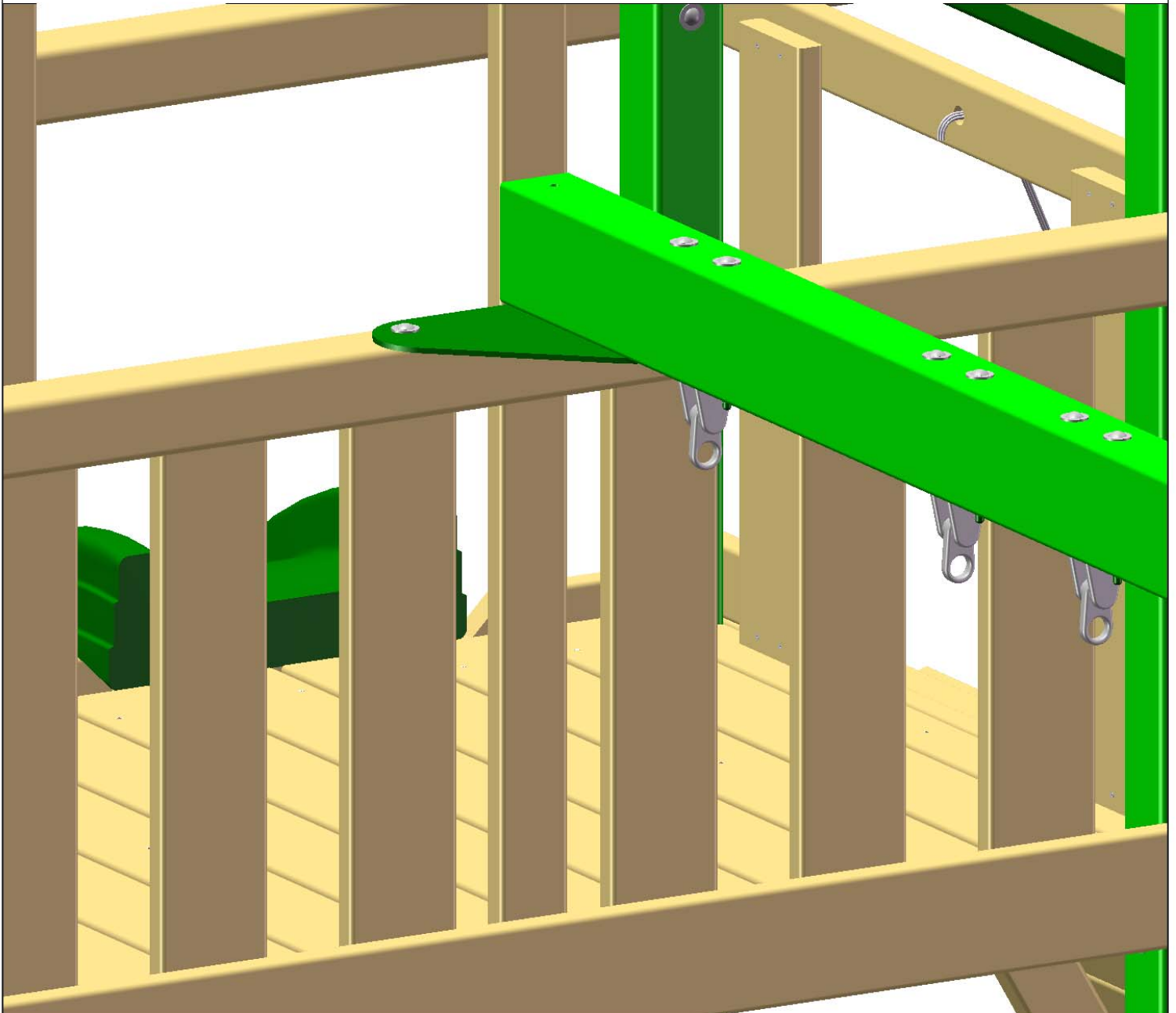

STEP 41: MOUNT SWING BEAM ON FORT

AN EXTRA PERSON IS NEEDED FOR THIS STEP

- 1: RAISE THE FREE END OF THE SWING BEAM TO FIT ON TOP OF THE SWING BEAM PLATE.
- 2: LINE UP THE PILOT HOLES AT THE END OF THE SWING BEAM WITH THE MIDDLE HOLES ON THE SWING BEAM PLATE.
- 3: FASTEN THE SWING BEAM TO THE SWING BEAM PLATE AND THE SWING BEAM SUPPORT USING A 9" CARRIAGE BOLT WITH A 1/2" WASHER AND A 3/8" LOCK NUT WITH A 3/8" WASHER. USE A BOLT CAP TO COVER EXPOSED THREADS.
- 4: FASTEN THE SWING BEAM TO THE SWING BEAM PLATE FROM UNDERNEATH WITH A 3/8 X 3-1/2" LAG SCREW AND 3/8" WASHER.
- 5: USE VICE GRIPS TO HOLD CARRIAGE BOLTS IN PLACE WHEN INSTALLING.

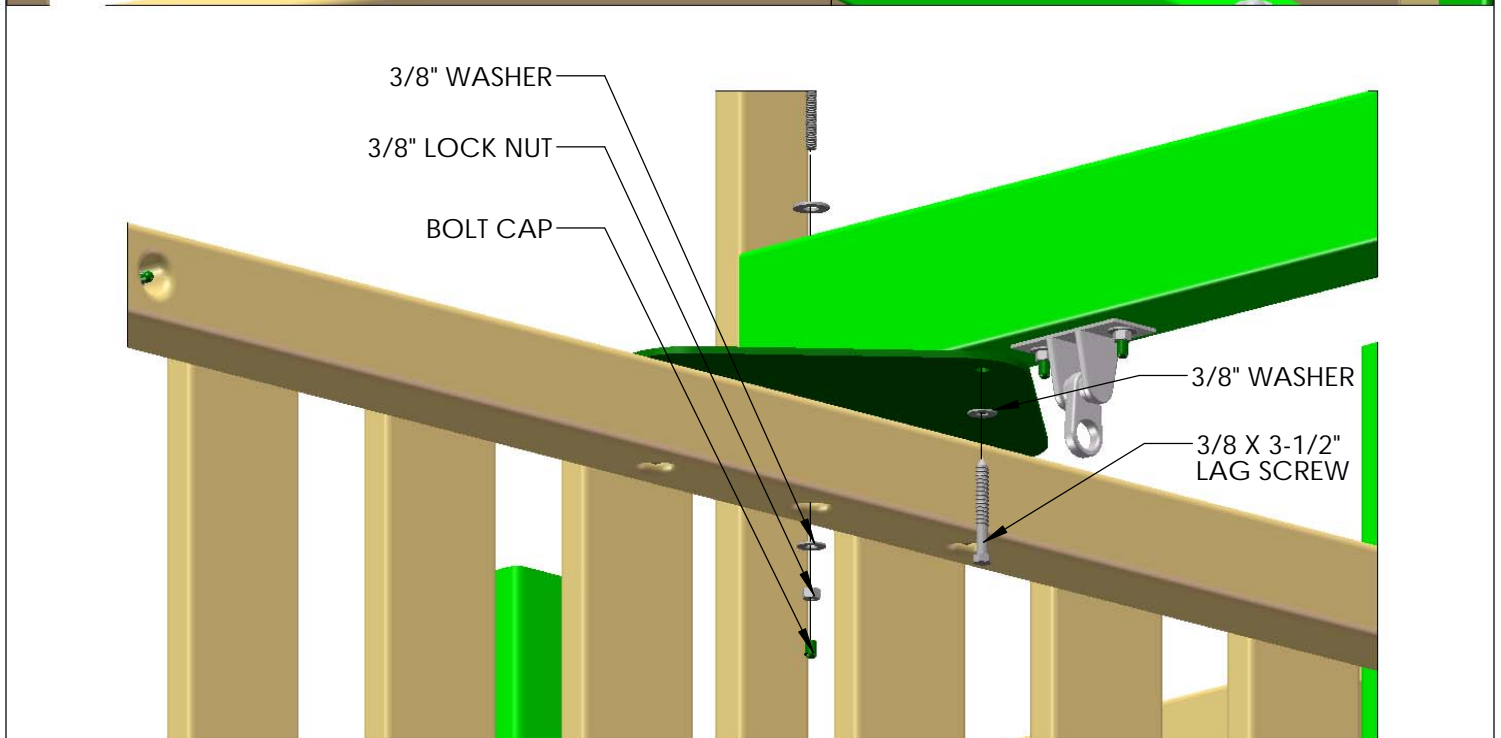
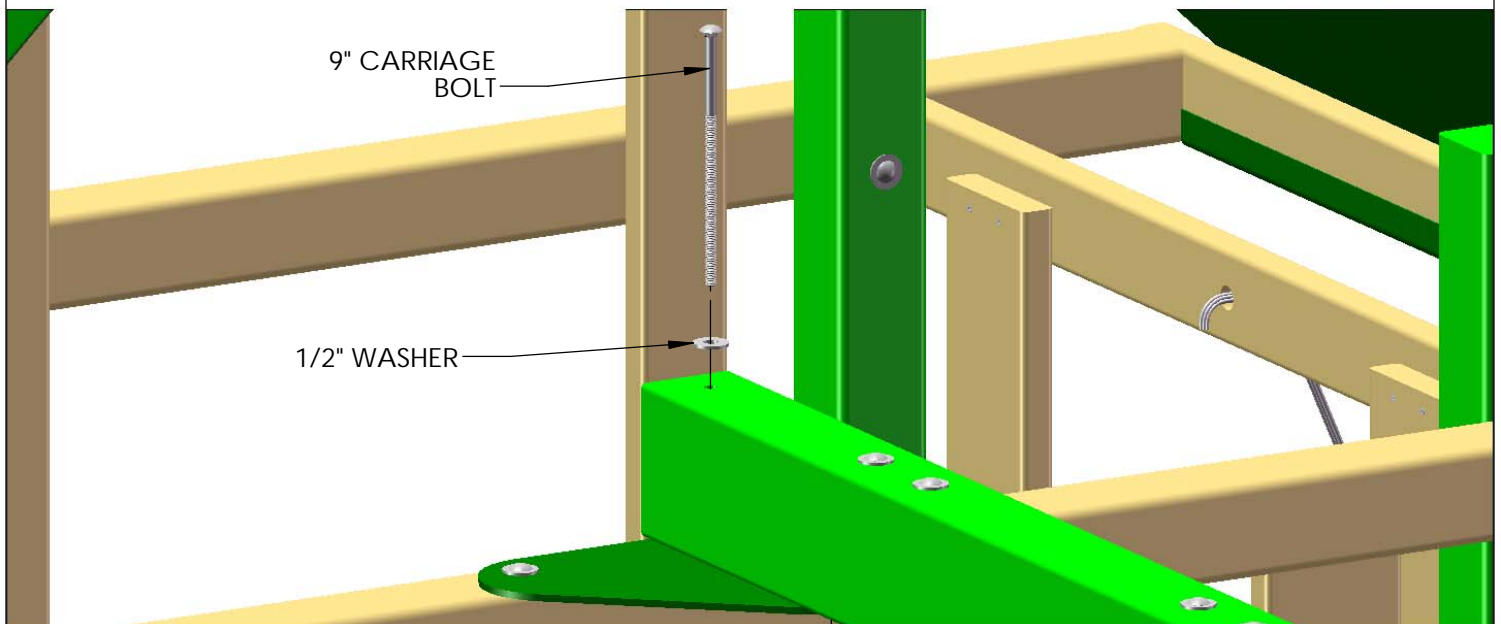

STEP 42: LEVEL SWING BEAM

1: PLACE A LEVEL ON TOP OF THE SWING BEAM AND ADJUST THE BEAM LEGS IN OR OUT AS NEEDED TO MAKE THE SWING BEAM LEVEL.

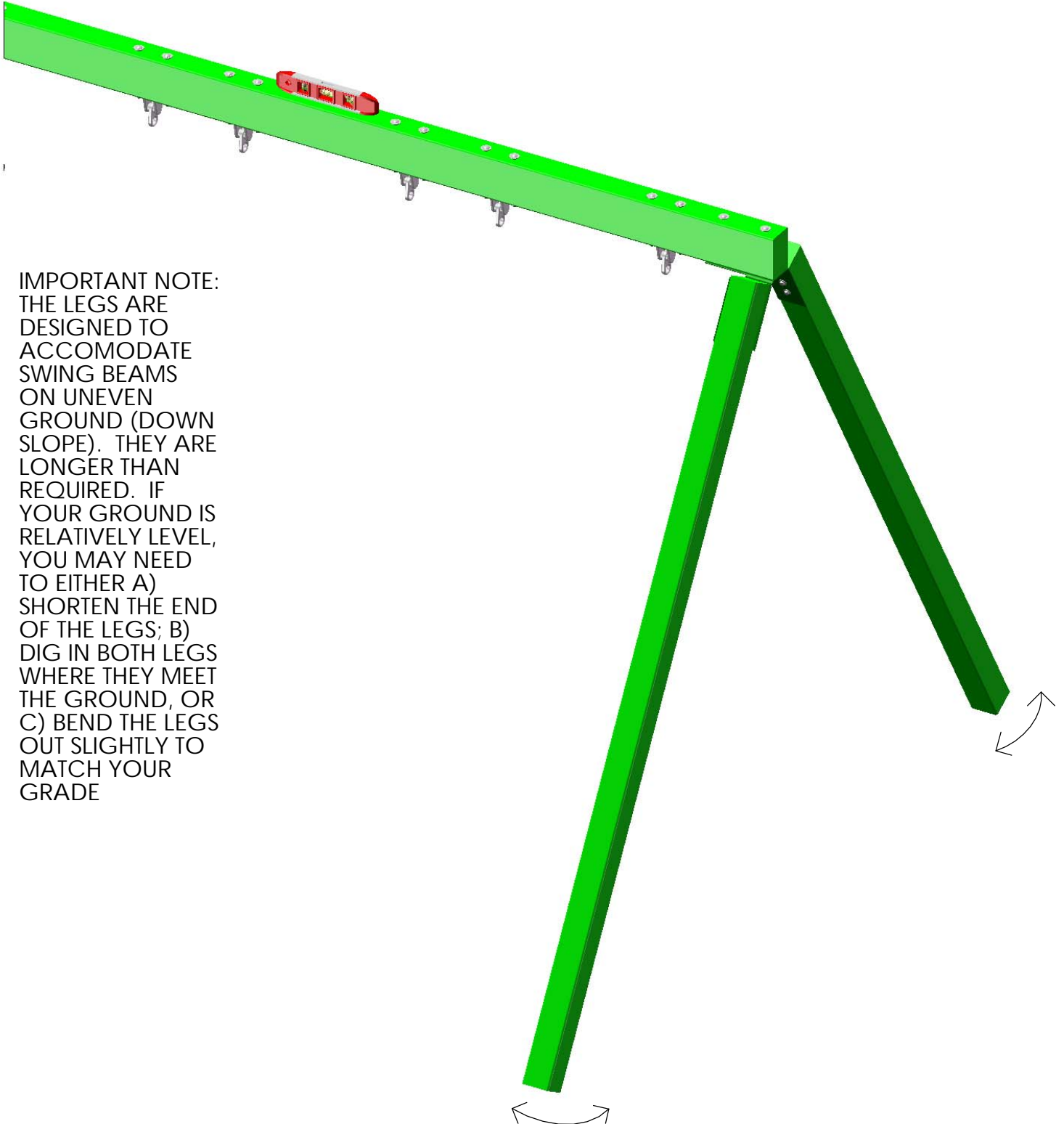

IMPORTANT NOTE:
THE LEGS ARE
DESIGNED TO
ACCOMMODATE
SWING BEAMS
ON UNEVEN
GROUND (DOWN
SLOPE). THEY ARE
LONGER THAN
REQUIRED. IF
YOUR GROUND IS
RELATIVELY LEVEL,
YOU MAY NEED
TO EITHER A)
SHORTEN THE END
OF THE LEGS; B)
DIG IN BOTH LEGS
WHERE THEY MEET
THE GROUND, OR
C) BEND THE LEGS
OUT SLIGHTLY TO
MATCH YOUR
GRADE

STEP 43: SWING LEG CROSS-MEMBER

- 1: POSITION THE 2 X 4 X 58" SWING LEG CROSS-MEMBER AGAINST THE SWING BEAM LEGS.
- 2: LEVEL CROSS-MEMBER AND MARK THE LOCATION OF THE SECURING HOLES INSIDE THE CROSS-MEMBER HOLES.
- 3: USE 3/8 X 3-1/2" LAG SCREWS WITH 3/8" WASHERS TO SECURE THE CROSS-MEMBER TO THE SWING BEAM LEGS.

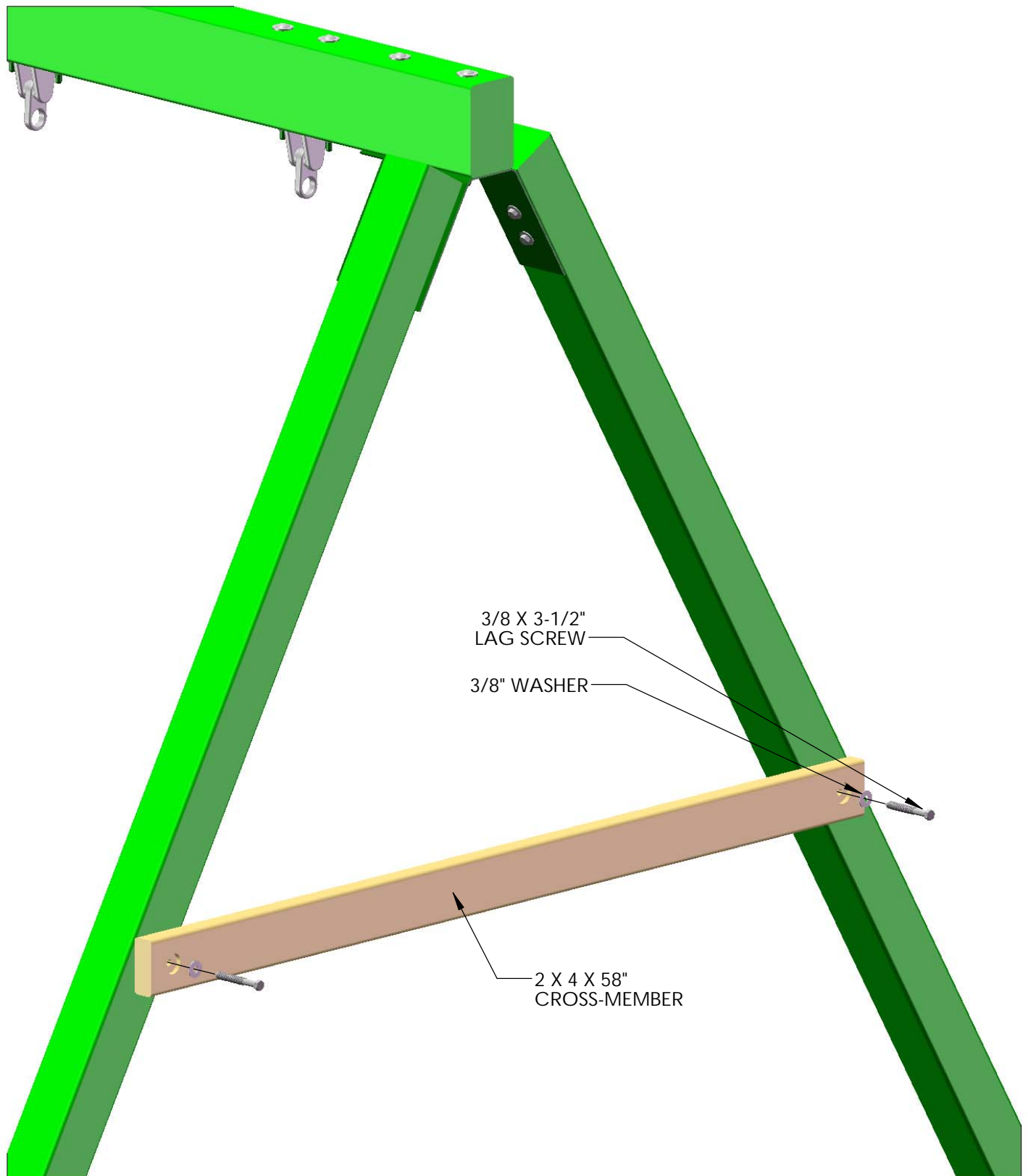

STEP 44: HANGING THE SWINGS

- 1: START BY ATTACHING ONE SPRING CLIP TO EACH IRON DUCTILE ON THE SWING BEAM.
- 2: ATTACH ONE CHAIN PER ACCESSORY TO EACH SPRING CLIP.
- 3: ADJUST HEIGHT AS NEEDED

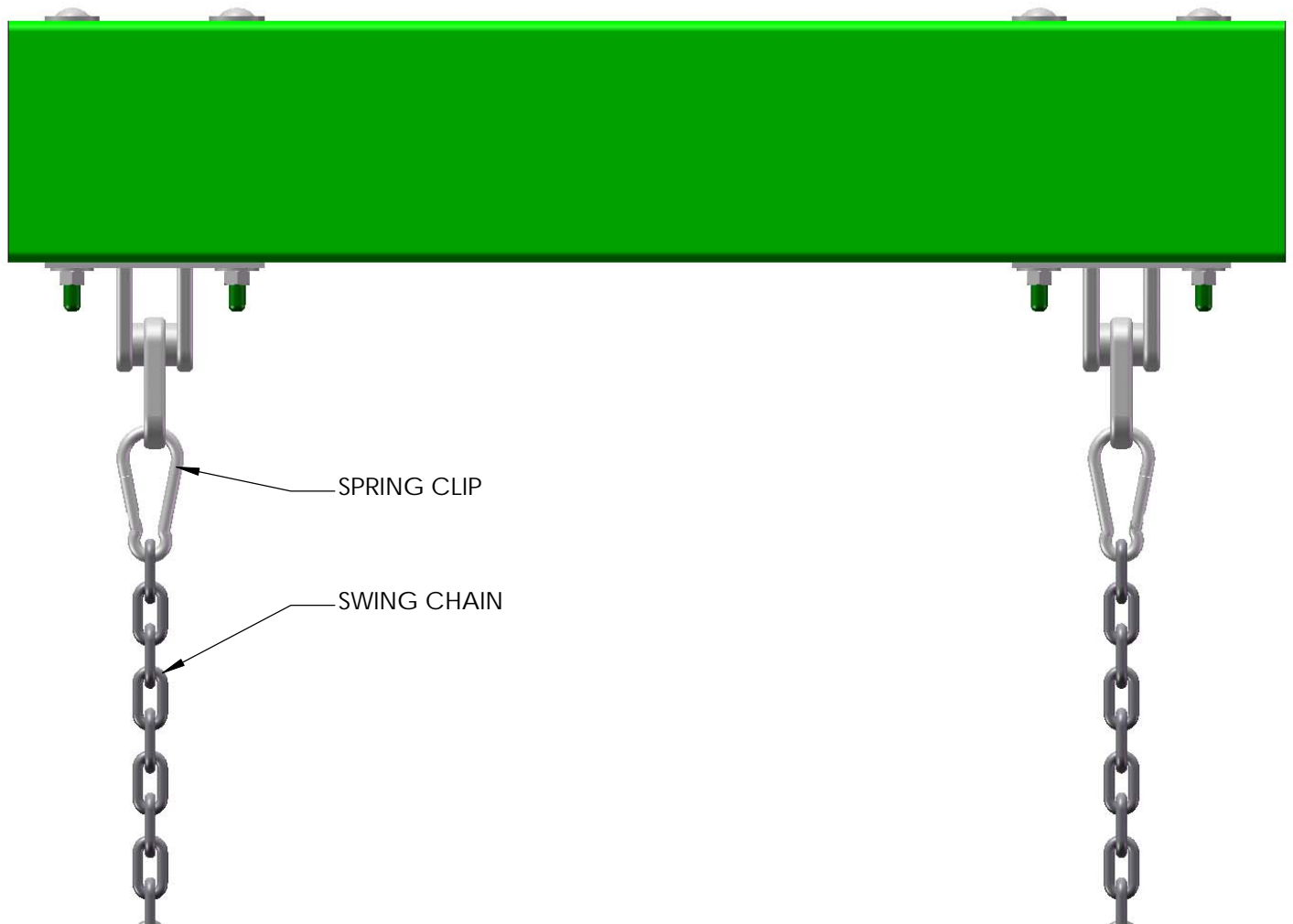

STEP 45: ROPE LADDER ASSEMBLY

1: DRILL THREE 1/8" PILOT HOLES 1" DEEP INTO THE BOTTOM OF THE ROPE LADDER SUPPORT (SEE DIMENSIONS BELOW).

2: PLACE THE EYEBOLT LAGS INTO THE HOLES AT THE BOTTOM OF THE ROPE LADDER SUPPORT AND TIGHTEN.

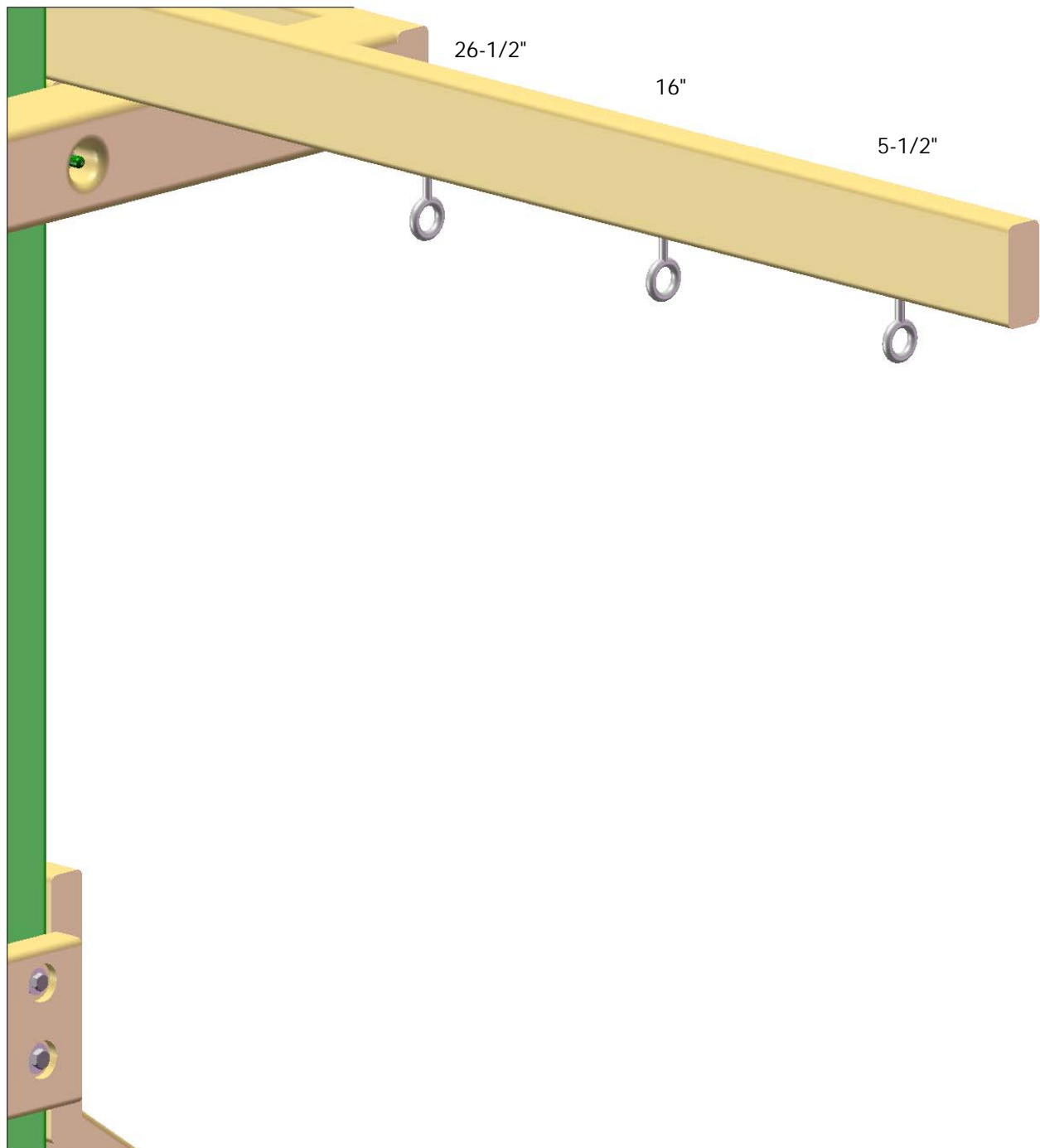

STEP 46: ROPE LADDER ASSEMBLY

- 1: PLACE THE HOOKS ON THE END OF THE ROPE LADDER ASSEMBLY THROUGH THE EYE OF THE EYBOLT LAG.
- 2: THREAD THE BOTTOM OF THE ROPE LADDER THROUGH THE HOLES IN THE ROPE LADDER RUNNER AND TIE A SECURE KNOT.



STEP 47: SAFETY HANDLES

- 1: PLACE THE SAFETY HANDLES IN THE DESIRED POSITION ON THE FORT.
- 2: FASTEN THE SAFETY HANDLES TO THE FORT WITH THE PROVIDED HARDWARE

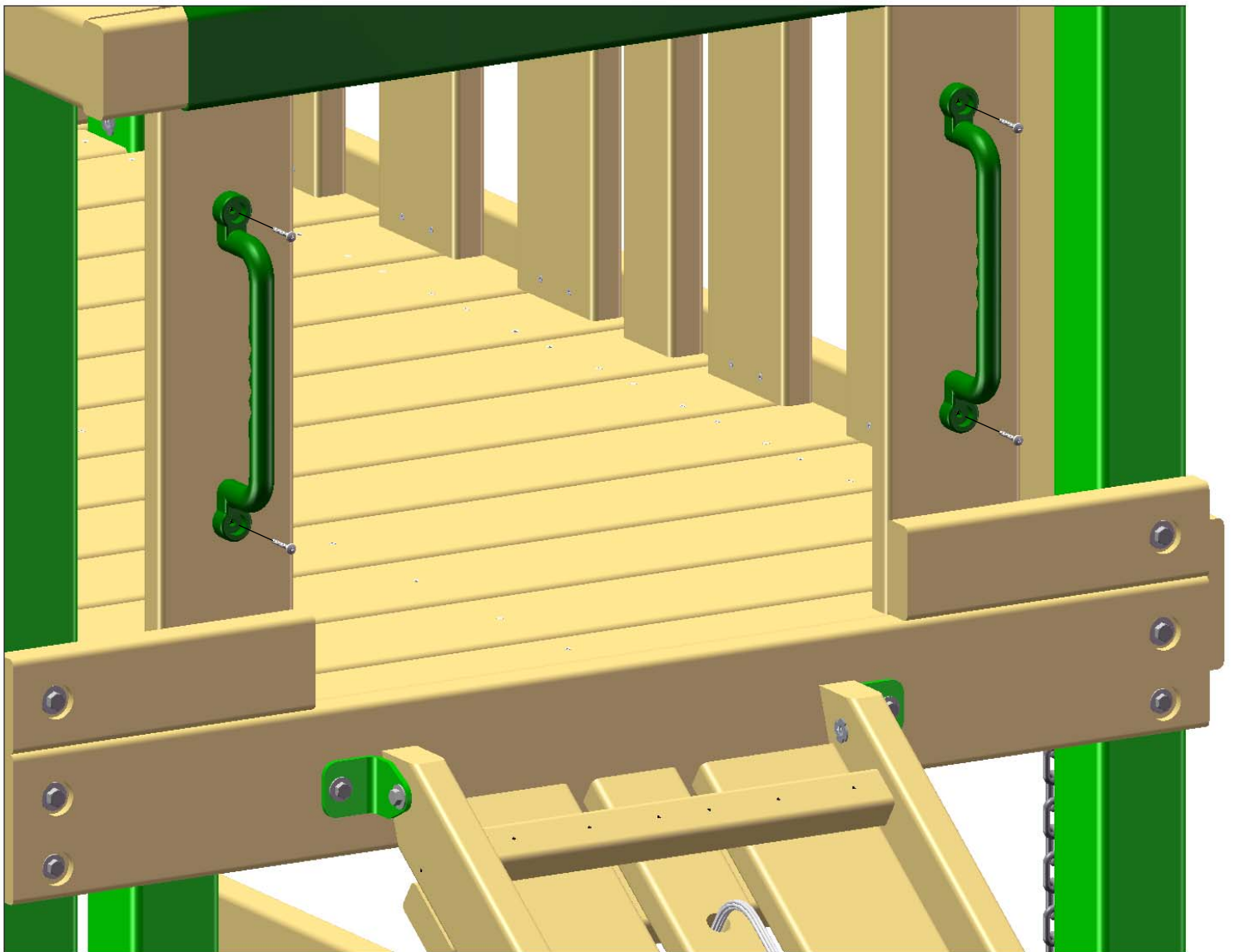

STEP 48: OPTIONAL GROUND STAKES

1: ATTACH THE 2 X 2 X 18" GROUND STAKES TO THE SWING LEGS FROM THE OUTSIDE WITH TWO 2-1/2" WOOD SCREWS PER STAKE. THE GROUND STAKES SHOULD BE APPROXIMATELY 6" ABOVE THE GROUND.

