

Blue Ridge Ranger – Deluxe Wood Roof Add-On ASSEMBLY MANUAL

Copyright © 2009 PlayNation Play Systems, Inc.
All Rights Reserved

PlayNation Play Systems, Inc. • 190 Etowah Industrial Court • Canton, GA 30114 • (800) 661-7295

7/JULY/2009 – Version 1.1.1

#8 X 1-1/2"
WOOD SCREW
QTY: 144



#8 X 2"
WOOD SCREW
QTY: 30



3/8 X 3-1/2"
LAG SCREW
QTY: 4



#2 SQUARE BIT
QTY: 1



3/8" WASHER
QTY: 4

9

8

7

6

5







4

3

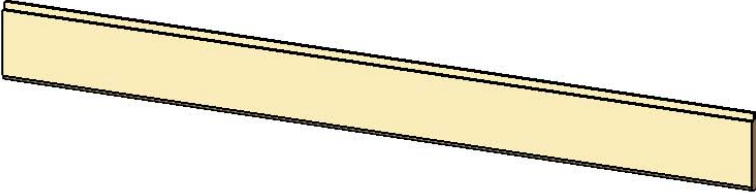
2

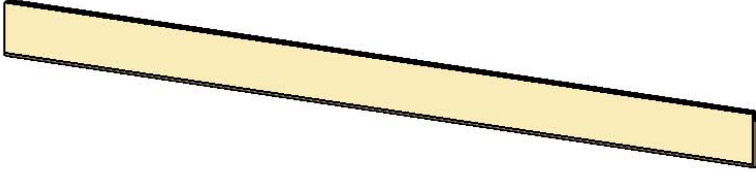
1

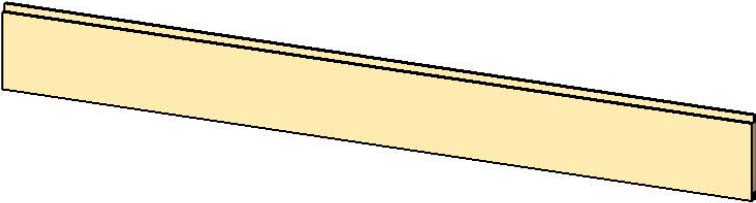
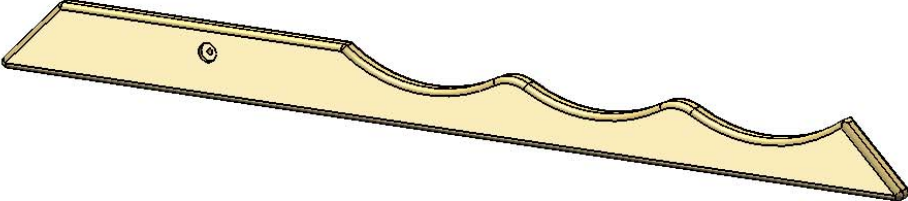
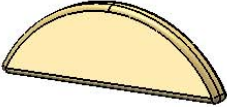
USE THE RULER TO THE RIGHT TO MEASURE YOUR BOLTS AND SCREWS. PICTURE VIEWS SHOWN ABOVE ARE 1:1 SCALE AND CAN BE USED TO MATCH BOLT AND SCREW SIZES.

	PICTURE	DESCRIPTION	QTY.
		1 X 5 X 54" TONGUE-ONLY ROOF FINISHER	2
		1 X 5 X 54" GROOVE-ONLY ROOF STARTER	2
		1 X 6 X 54" TONGUE-AND- GROOVE ROOF BOARD	24
	2 X 5 X 66" SCALLOPED ROOF SUPPORT	2 LEFT 2 RIGHT	
	2 X 6 X 16" SUN	2	
	$\frac{5}{4}$ X 2 X 10" SMALL RAY	12	
	$\frac{5}{4}$ X 2 X 16" SMALL RAY	2	

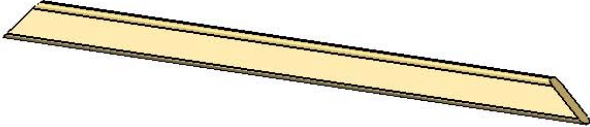
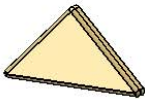
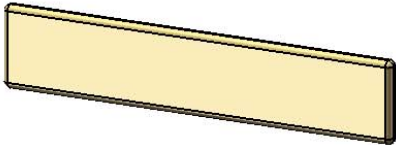
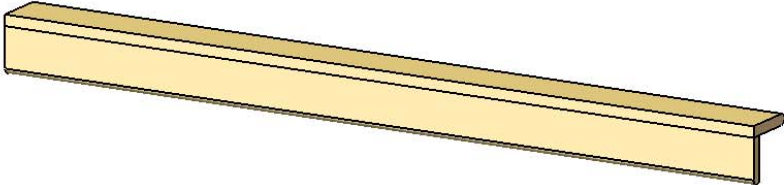
PICTURE	DESCRIPTION	QTY.
	$\frac{5}{4}$ X 3 X 42" SUN SUPPORT	2
	$\frac{5}{4}$ X 6 X 10" ROOF PEAK SUPPORT	2
	$\frac{5}{4}$ X 6 X 28" PANEL SLAT	2
	54" ROOF PEAK ASSEMBLY	1

COUNT AND ORGANIZE YOUR LUMBER INTO LIKE STACKS (2 X 4, 2 X 6, 4 X 4, 4 X 6, ETC.). THIS WILL HELP IN IDENTIFYING COMPONENTS AND REDUCE YOUR BUILDING TIME

PICTURE

DESCRIPTION

QTY.

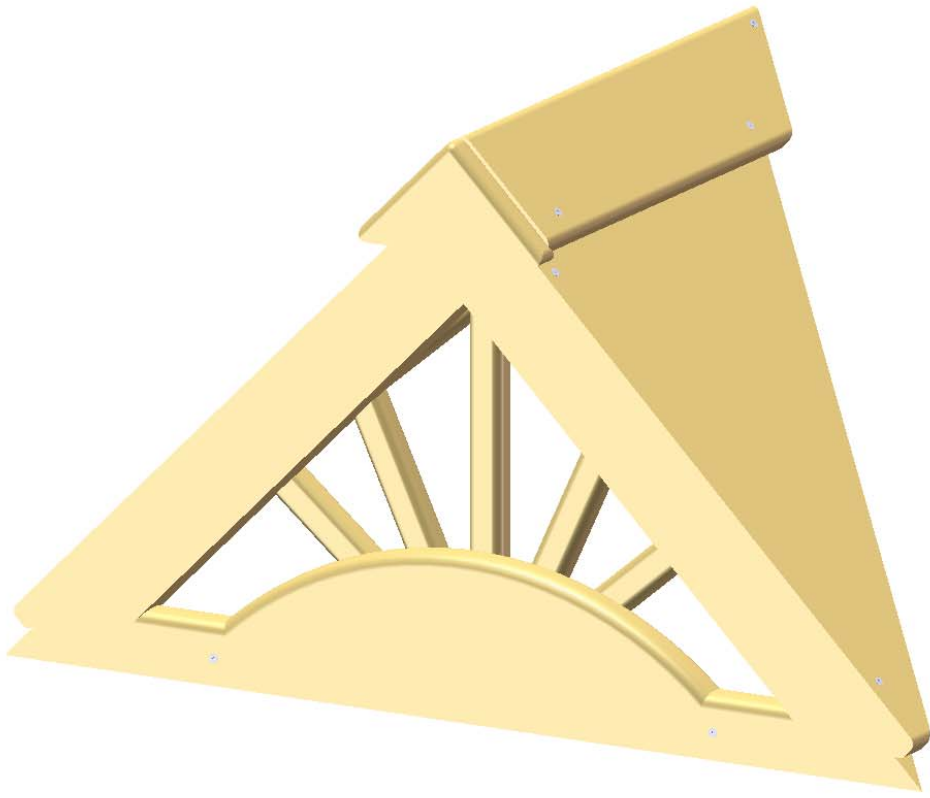

UNASSEMBLED
DORMER

2

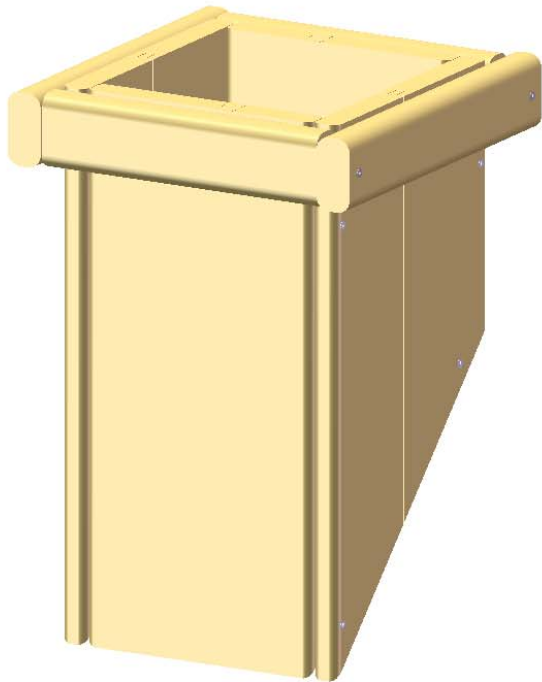

UNASSEMBLED
CHIMNEY

1

STEP 1: PANEL SLATS*

1: FIND TWO 5/4 X 6 X 28" PANEL SLATS. THE PANEL SLATS WILL REPLACE THE 2 X 4 X 72" CENTER POSTS.

2: REMOVE THE TARP, 2 X 4 X 72" CENTER POSTS, 2 X 4 X 47-1/2" CENTER TARP BOARD, AND THE 2 X 4 X 54-1/2" END TARP BOARDS FROM THE UNIT. IN THE SAME PLACE THAT THE 72" CENTER POSTS WERE INSTALLED, ATTACH THE 28" CENTER POSTS.

3: USE TWO 2" WOOD SCREWS IN THE TOP AND BOTTOM OF THE PANEL SLATS (FOUR TOTAL).

4: YOU MAY NEED TO REMOVE THE PANEL SLATS FROM THE SWING BEAM AND SLIDE SIDES OF THE UNIT, AND RE-CENTER THE SLATS ON THE WALL.

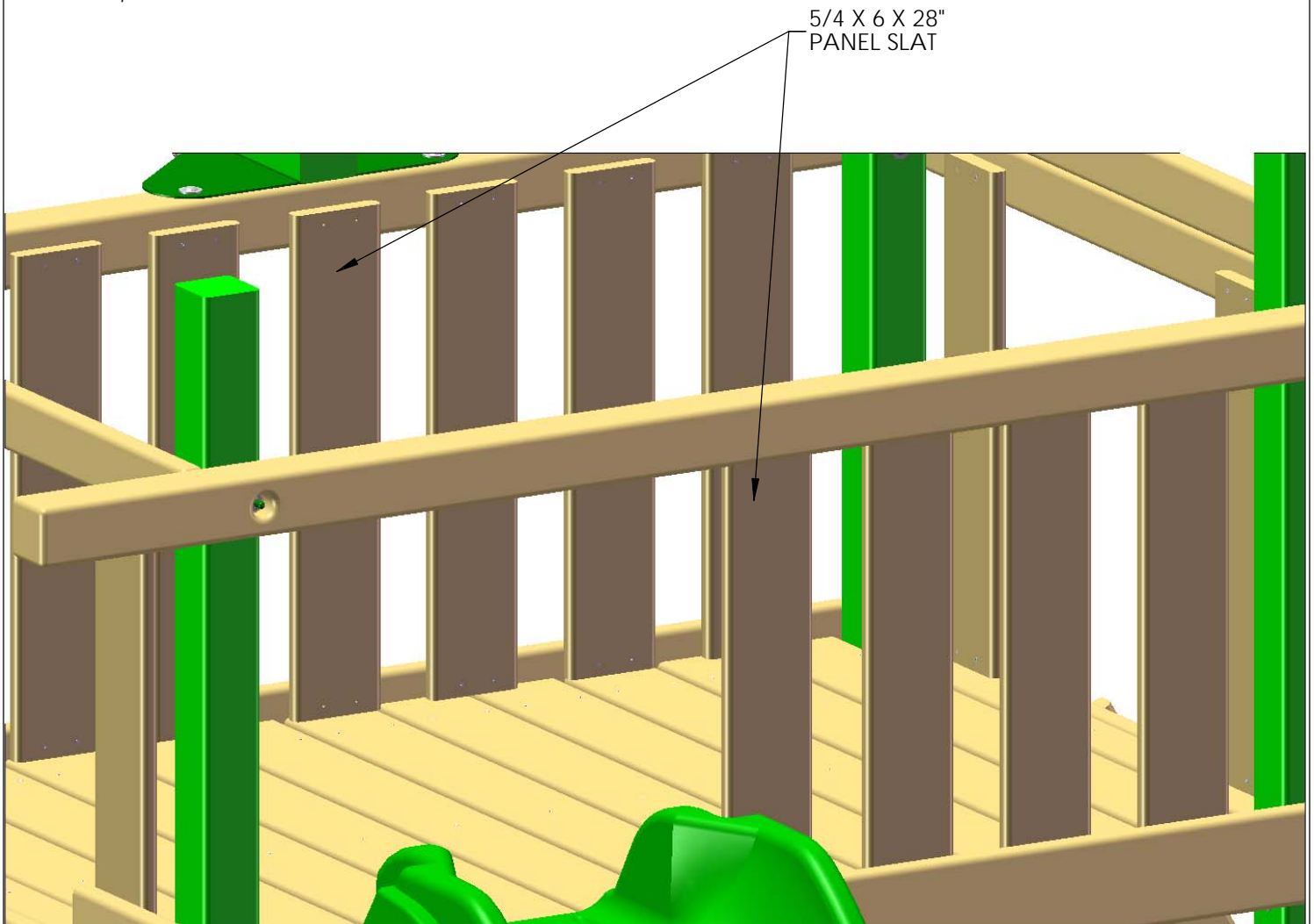

*THESE INSTRUCTIONS ARE FOR A RANGER DELUXE UPGRADE. IF YOU PURCHASED THE RANGER DELUXE UNIT YOU WILL NOT BE REMOVING ANY BOARDS. IT SHOULD ALSO BE NOTED THAT IF YOU PURCHASED THE RANGER DELUXE, AT THIS POINT IN YOUR ASSEMBLY, MANY OF THESE BOARDS HAVE NOT YET BEEN INSTALLED. IT IS RECOMMENDED THAT YOU RETURN TO YOUR PLAYSET INSTRUCTIONS AFTER COMPLETING THIS STEP, AND SKIP OVER ANY PAGES REFERRING TO TARP BOARD INSTALLATION. THE REMAINING STEPS IN THIS MANUAL SHOULD BE RESUMED AFTER THE REST OF THE UNIT HAS BEEN ASSEMBLED.

STEP 2: ROOF SUPPORTS

1: FIND FOUR 2 X 5 X 66" SCALLOPED ROOF SUPPORTS. THERE WILL BE TWO FOR THE LEFT AND TWO FOR THE RIGHT.

2: PLACE ONE LEFT AND ONE RIGHT SIDE ROOF SUPPORT ON THE SIDE RAIL. THE ENDS SHOULD MEET AND LOOK LIKE THE TOP PART OF A GIANT "A". CENTER THE BOARDS ALONG THE SIDE RAIL, AND FASTEN WITH 3/8 X 3-1/2" LAG SCREWS AND 3/8" WASHERS.

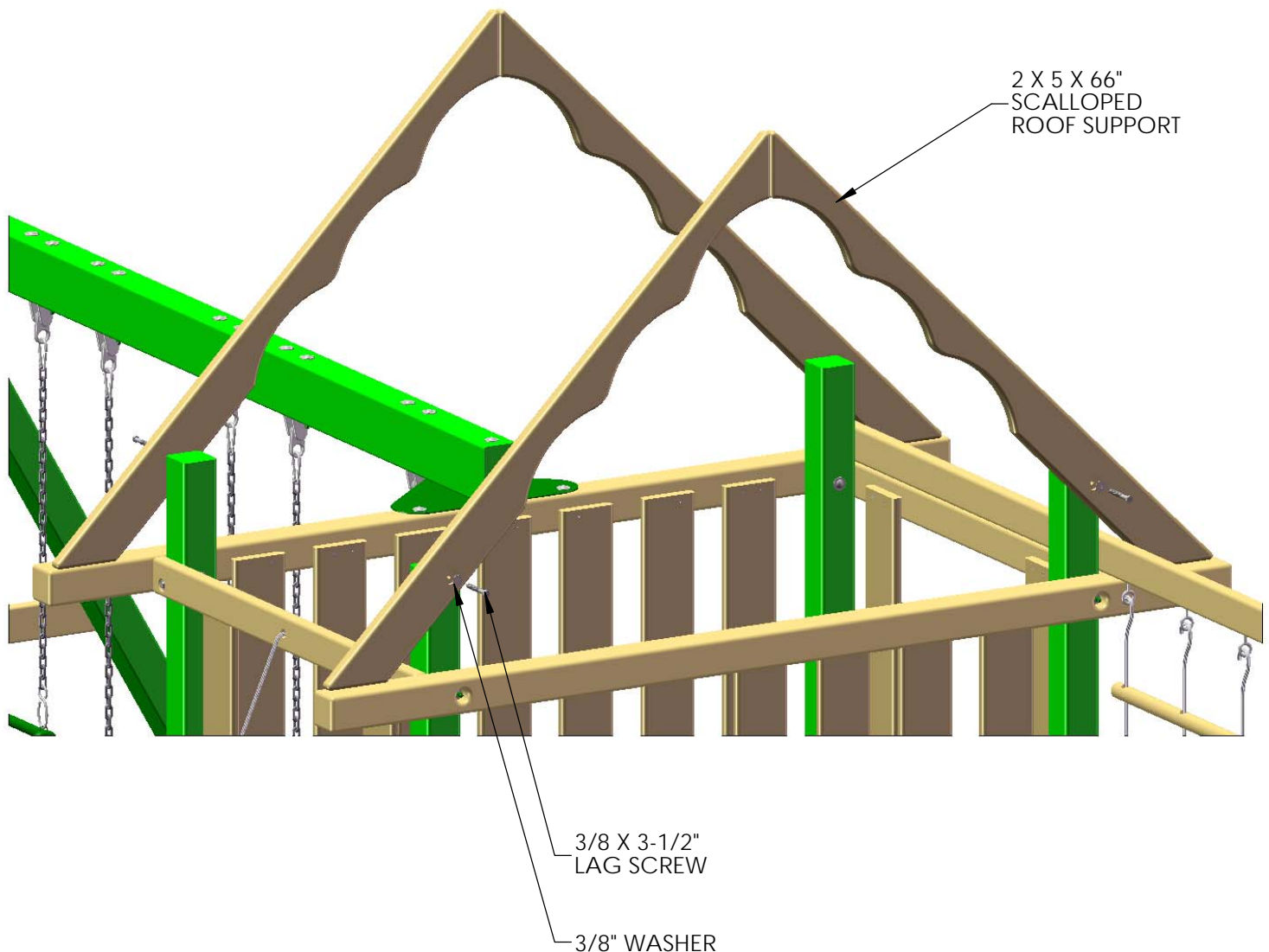

STEP 3: ROOF PEAK SUPPORTS

1: FIND TWO 5/4 X 6 X 10" ROOF PEAK SUPPORTS.

2: PLACE THE ROOF PEAK SUPPORTS AT THE PEAK FORMED BY THE TWO SCALLOPED ROOF SUPPORTS. FASTEN THE ROOF PEAK SUPPORTS TO THE SCALLOPED ROOF SUPPORTS WITH THREE 2" WOOD SCREWS PER SIDE (SIX TOTAL IN EACH BOARD).

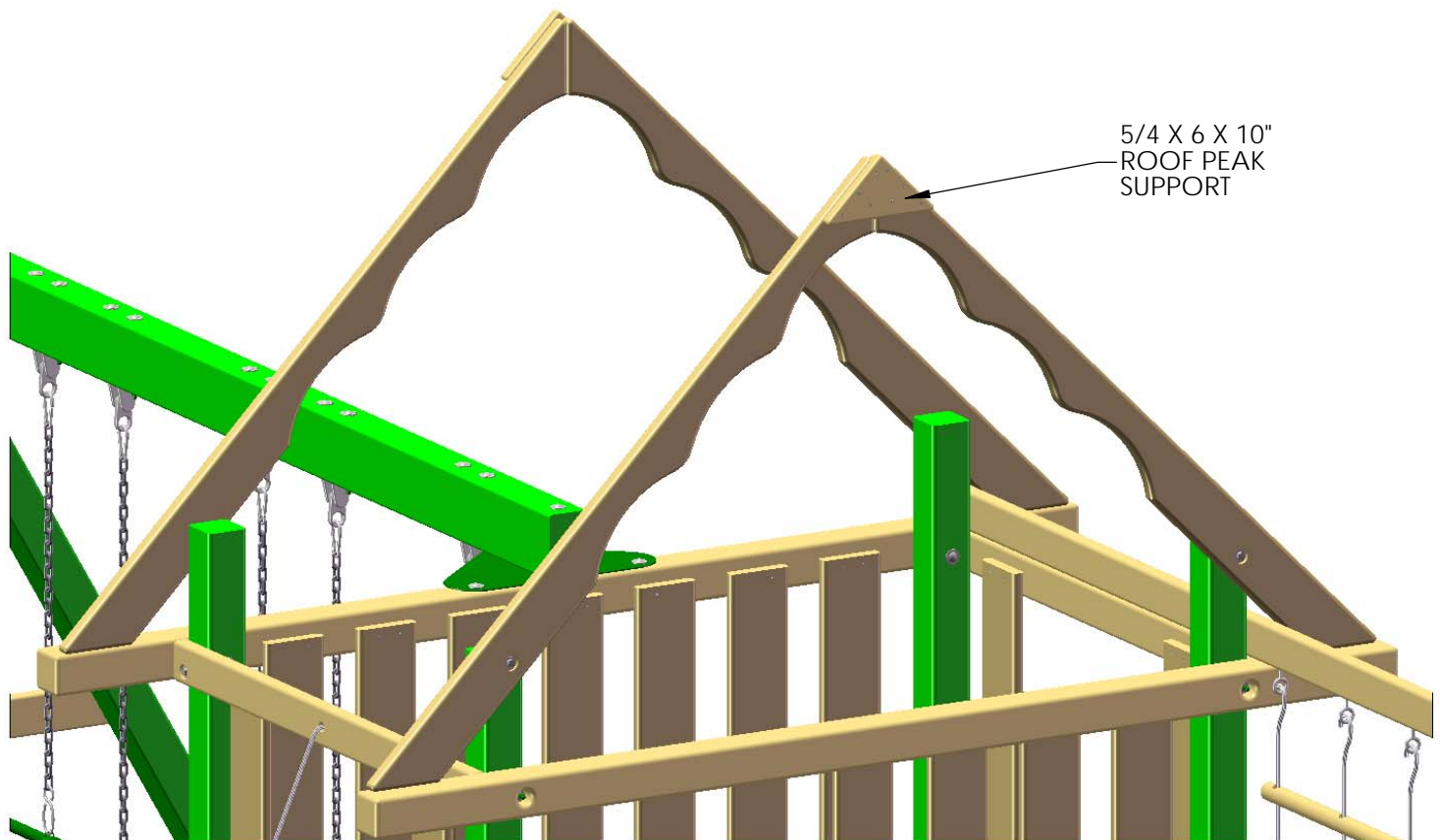

STEP 4: ROOF

1: PLACE THE 1 X 5 X 54" GROOVE-ONLY ROOF STARTER BOARDS AT THE PEAK OF THE ROOF. THE FLAT ENDS OF THE ROOF STARTERS SHOULD BE PLACED AS CLOSE TO EACH OTHER AS POSSIBLE WITHOUT THE BOARDS OVERLAPPING.

2: FASTEN THE ROOF STARTER BOARDS TO THE ROOF SUPPORTS WITH 1-1/2" WOOD SCREWS.

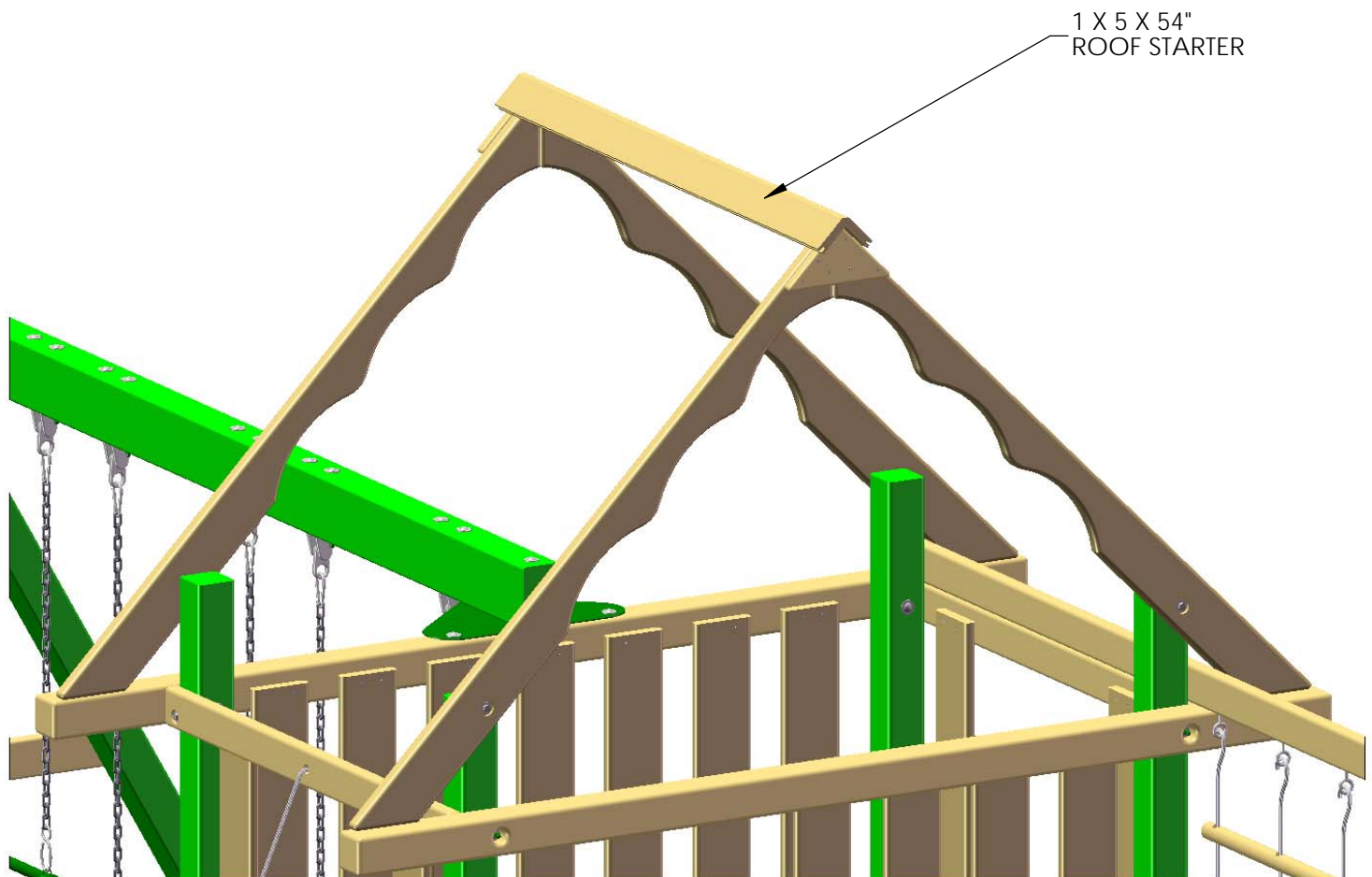

STEP 5: ROOF

1: PLACE THE 54" ROOF PEAK ON TOP OF THE ROOF STATER BOARDS.

2: FASTEN THE ROOF PEAK TO THE ROOF STARTER BOARDS WITH 1-1/2" WOOD SCREWS.

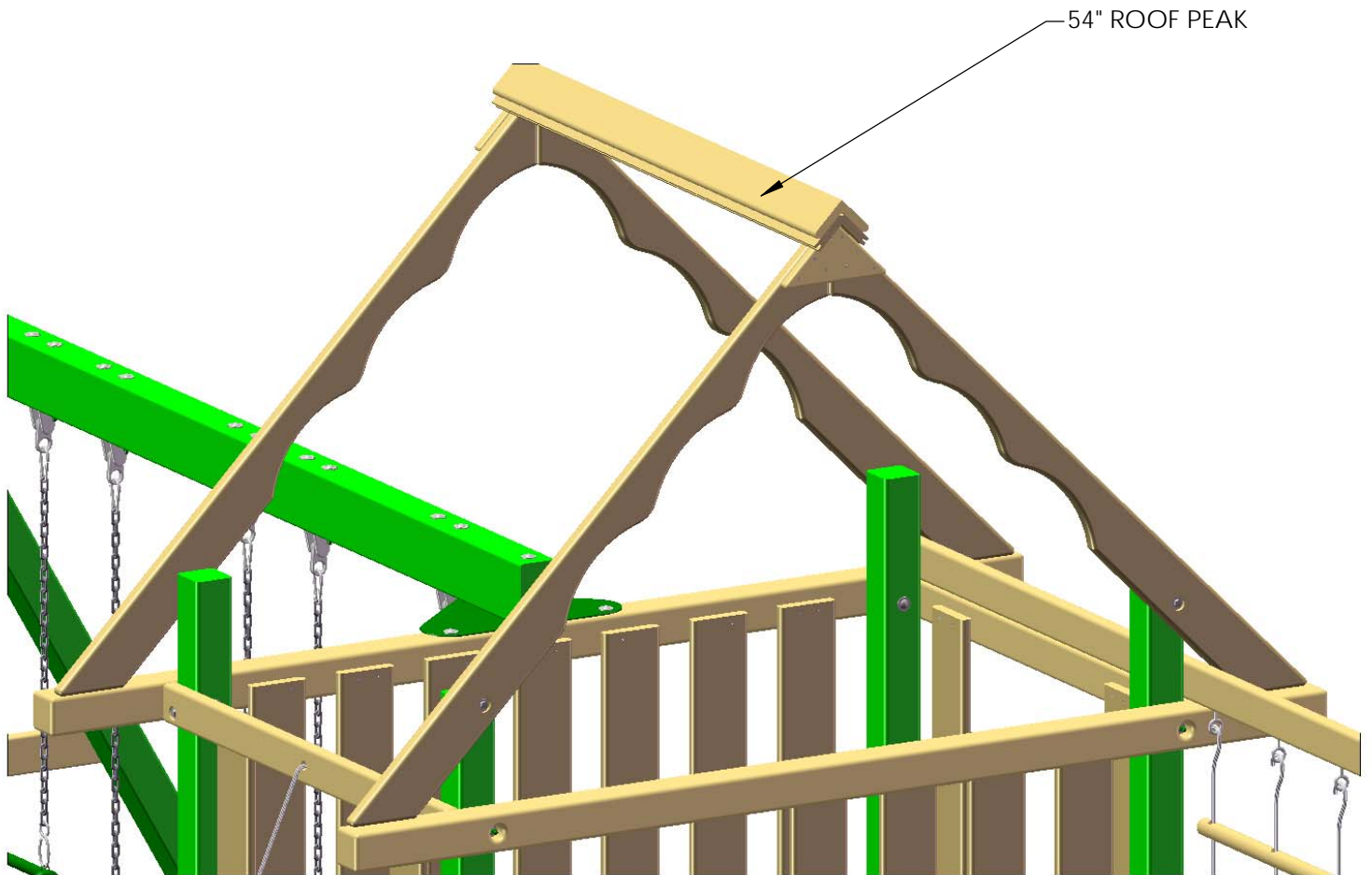

STEP 6: ROOF

1: PLACE THE 1 X 6 X 54" ROOF BOARDS ON TOP OF THE ROOF SUPPORTS, FITTING THE TONGUE END INTO THE GROOVE END OF THE ROOF STARTERS. EACH SIDE OF THE ROOF GETS TWELVE ROOF BOARDS.

2: FASTEN THE ROOF BOARDS TO THE ROOF SUPPORTS WITH 1-1/2" WOOD SCREWS.

3: PLACE A 1 X 5 X 54" ROOF FINISHER AT THE END OF THE ROOF ASSEMBLY, AND FASTEN WITH 1-1/2" WOOD SCREWS.

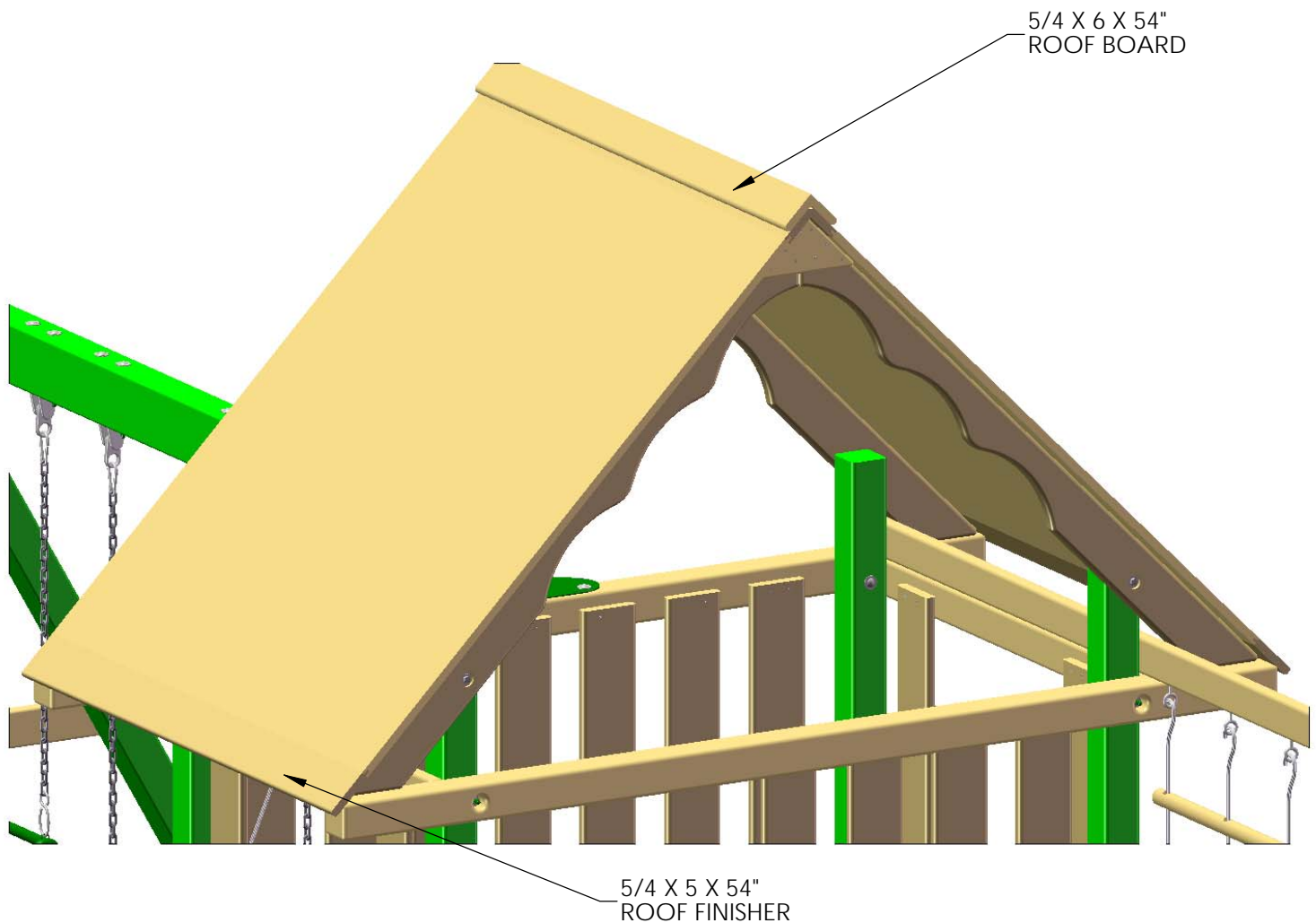

STEP 7: SUNBURST

1: PRE-DRILL HOLES IN THE 2 X 6 X 16" SUN TO THE PATTERN SHOWN BELOW.

2 X 6 X 16"
SUN

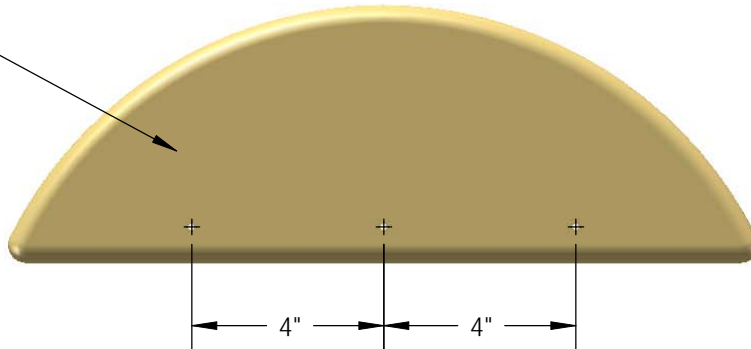

2: PLACE THE 2 X 6 X 16" SUN CENTERED AGAINST THE 5/4 X 3 X 42" SUN SUPPORT. FASTEN THE SUN TO THE SUN SUPPORT WITH 2" WOOD SCREWS.

5/4 X 3 X 42"
SUN SUPPORT

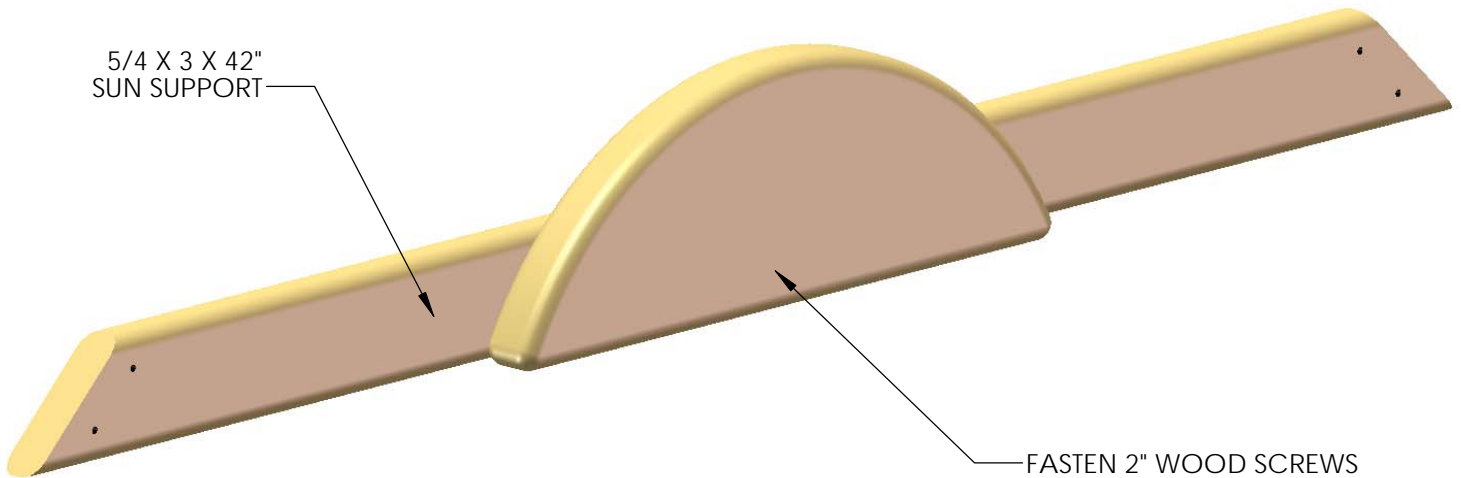

FASTEN 2" WOOD SCREWS
FROM THIS SIDE

STEP 8: SUNBURST

1: PLACE THE ASSEMBLY MADE IN THE PREVIOUS STEP UNDERNEATH THE ROOF BOARDS, AND AGAINST THE ANGLED ROOF SUPPORTS. MAKE SURE THE ASSEMBLY IS LEVEL BEFORE PROCEEDING TO THE NEXT STEP.

2: FASTEN THE SUN ASSEMBLY TO THE FORT WITH 2" WOOD SCREWS FROM THE OUTSIDE INTO THE ROOF SUPPORTS.

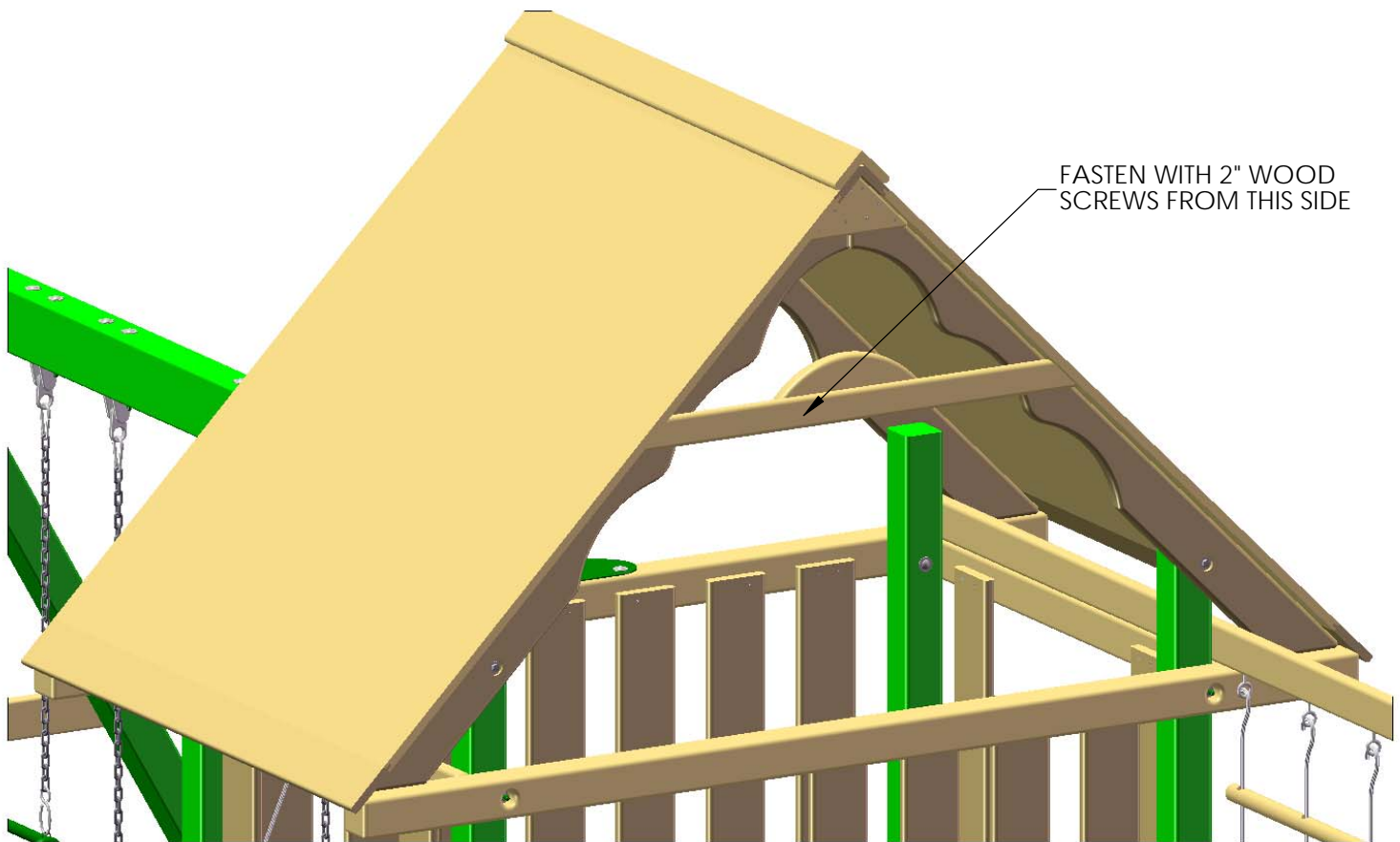

STEP 9: SUNBURST

1: PREDRILL ALL SUNRAYS AT 1/2" ON CENTER FROM EACH END.

2: CENTER THE 5/4 X 2 X 16" LARGE RAY ONTO THE HALF SUN AND THE ROOF SUPPORT BOARDS AND FASTEN WITH TWO 1-1/2" SCREWS.

3: EQUALLY SPACE THE SMALL RAYS ABOUT THE HALF SUN (THREE ON EACH SIDE OF LARGE RAY) AND MARK THE POSITION OF THE SMALL SUNRAYS WITH A PENCIL.

4: SECURE THE SMALL SUNRAYS ONE AT A TIME TO THE HALF SUN AND THE ROOF SUPPORT BEAMS AND LINE THEM UP WITH THE MARK DRAWN. FASTEN THE SMALL SUNRAYS WITH TWO 1-1/2" WOOD SCREWS EACH. REPEAT ON OTHER SIDE OF FORT.

NOTE:
ROOF BOARDS REMOVED FROM VIEW FOR CLARITY

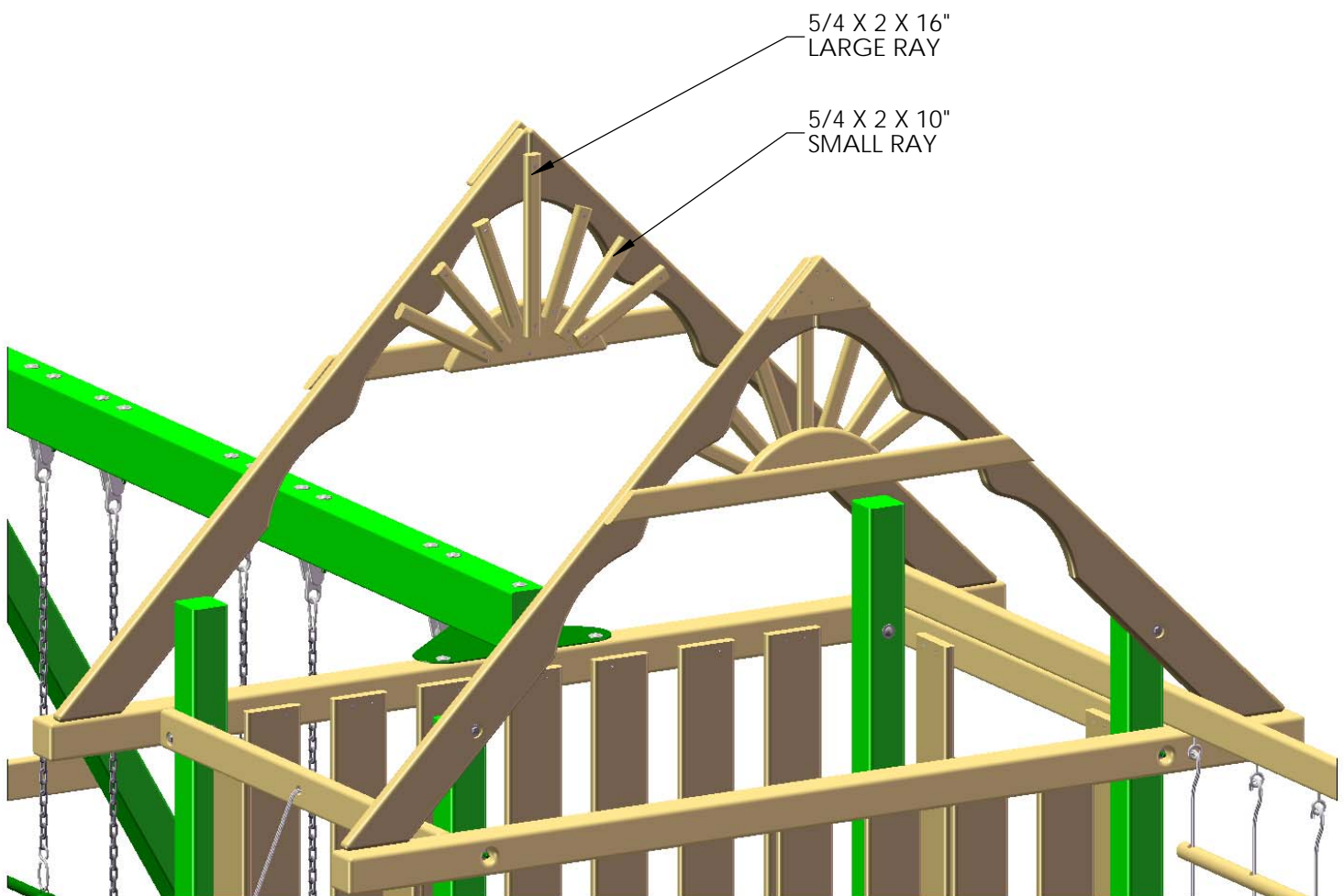

STEP 10: DORMER

- 1: FIND TWO LEFT SIDE AND TWO RIGHT SIDE DORMER ROOF ASSEMBLIES.
- 2: FIND TWO DORMER SUNRAY ASSEMBLIES.
- 3: PLACE THE LEFT AND RIGHT ROOF ASSEMBLIES ON THE BACK SIDE OF THE DORMER SUNRAY ASSEMBLY AS SHOWN BELOW.
- 4: ATTACH THE DORMER ROOF SIDES TO THE DORMER SUNRAY WITH 1-1/4" WOOD SCREWS FROM THE ROOF BOARDS OF THE ROOF ASSEMBLIES.

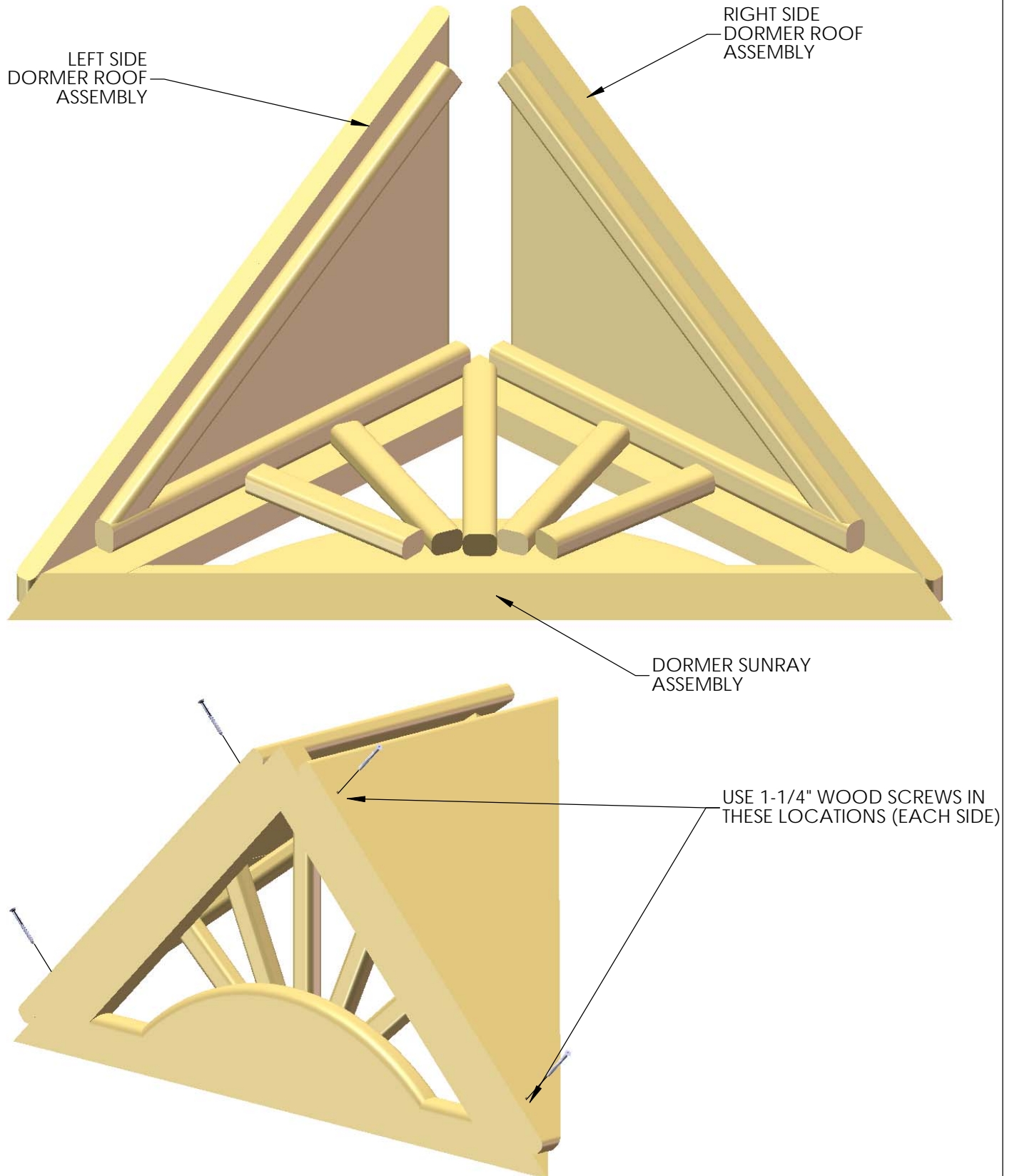

STEP 11: DORMER

1: FIND THE DORMER ROOF PEAK ASSEMBLY.

2: PLACE THE ROOF PEAK ASSEMBLY IN THE TOP OF THE ROOF AND FASTEN WITH 1-1/4" WOOD SCREWS.

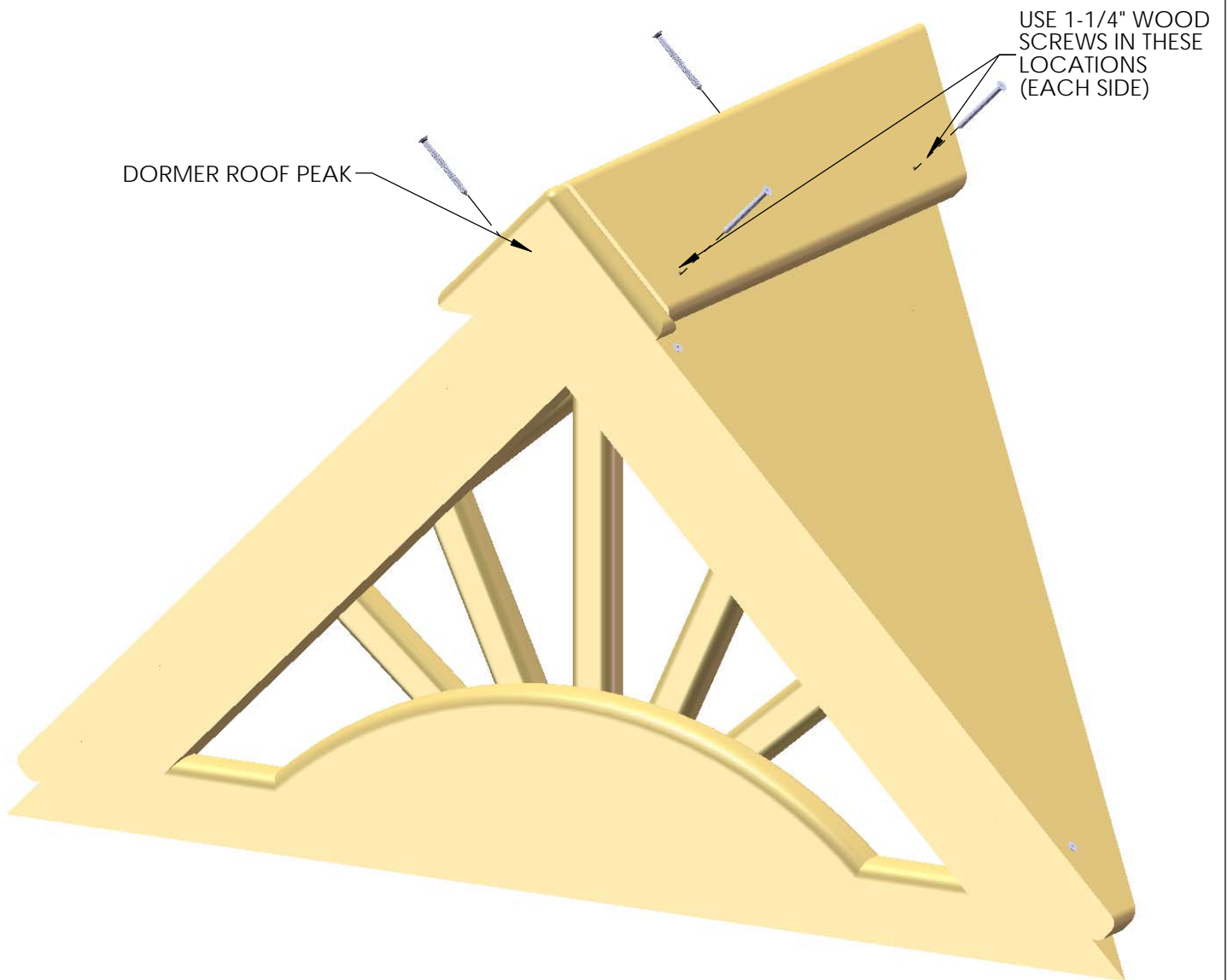

STEP 12: DORMER

- 1: CENTER THE DORMER ASSEMBLIES ON THE ROOF.
- 2: USE 2" WOOD SCREWS TO FASTEN THE DORMERS TO THE ROOF.

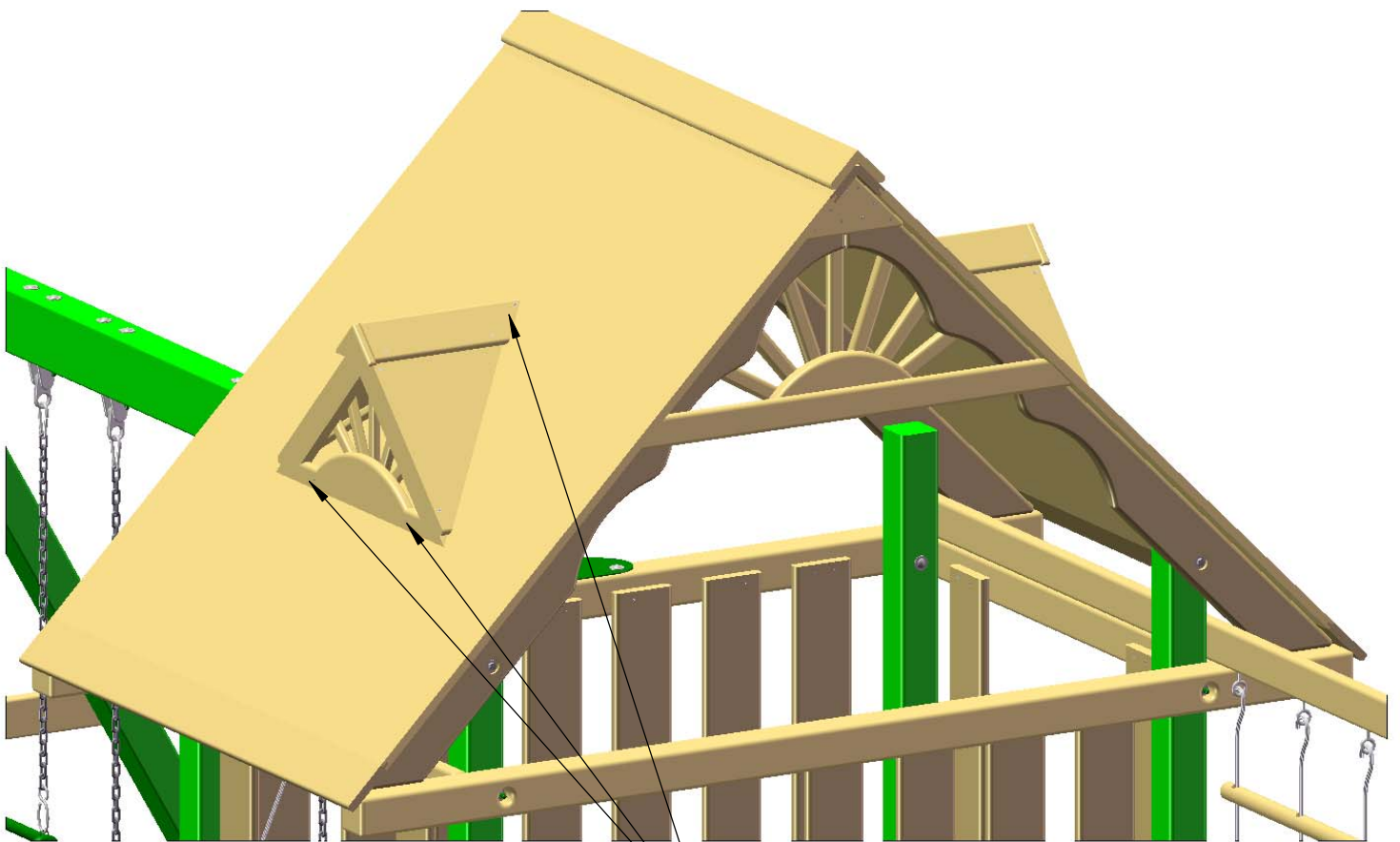

USE 2" WOOD SCREWS IN
THESE LOCATIONS (EACH SIDE)

STEP 13: CHIMNEY

1: FIND THE FRONT AND LEFT SIDE OF THE CHIMNEY.

2: ATTACH THE FRONT AND LEFT SIDES OF THE CHIMNEY WITH A 2" WOOD SCREW.

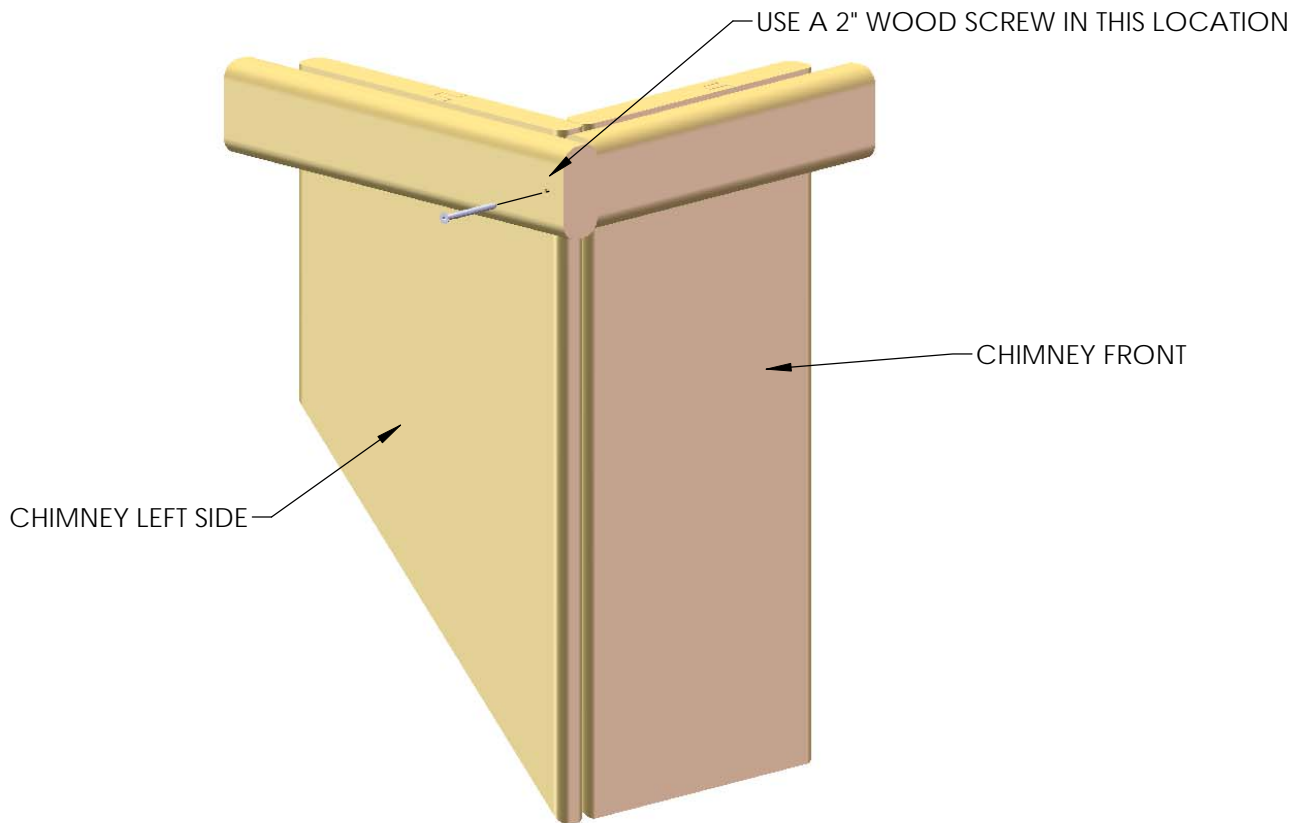

1: FIND THE REAR AND RIGHT SIDE OF THE CHIMNEY.

2: ATTACH THE REAR AND RIGHT SIDES OF THE CHIMNEY WITH A 2" WOOD SCREW.

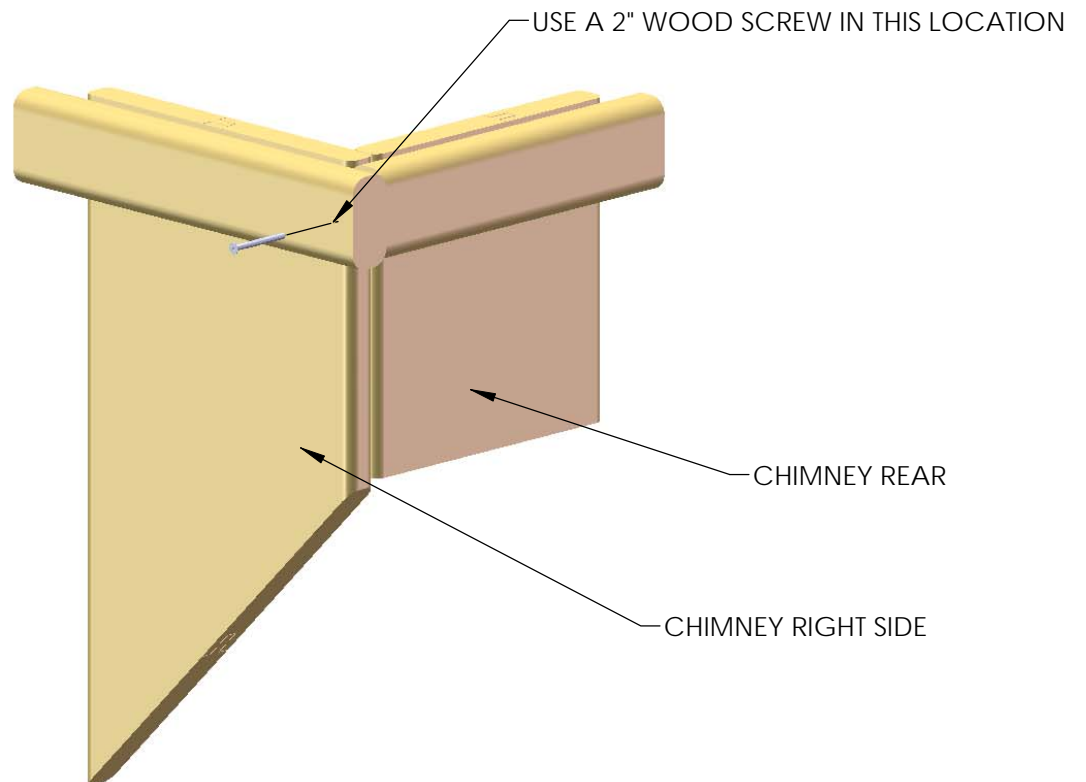

STEP 14: CHIMNEY

1: ATTACH THE CHIMNEY SIDES FROM THE PREVIOUS SIDES TO FORM THE CHIMNEY WITH 2" AND 1-1/4" WOOD SCREWS.

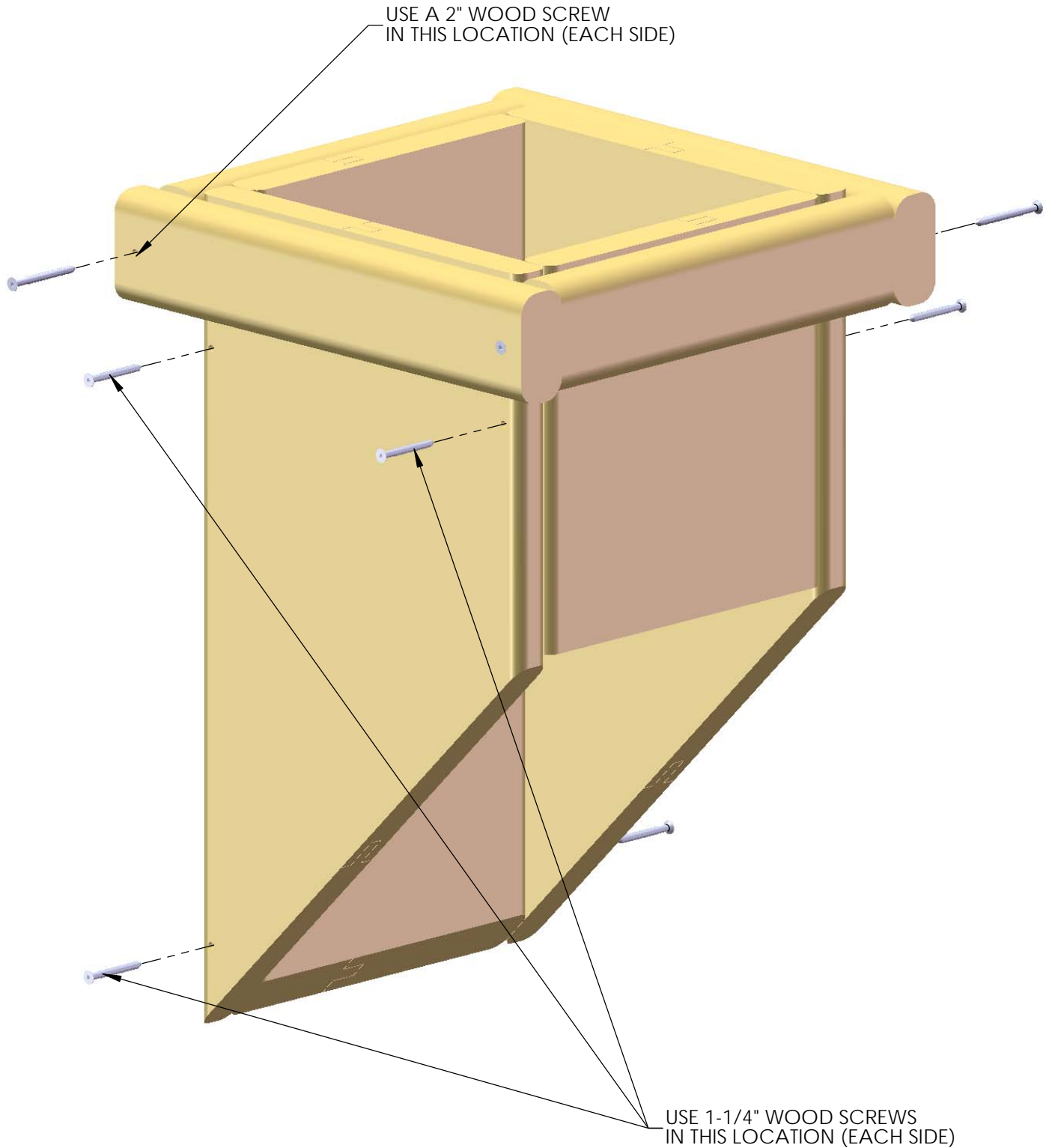

STEP 15: CHIMNEY

1: FASTEN THE 5/4 X 3 X 6-3/4" CHIMNEY MOUNTING BLOCK TO THE ROOF WITH 1-1/2" WOOD SCREWS. YOU CAN PLACE THE BLOCK AT ANY DESIRED PLACE ON THE ROOF. USE THE DIAGRAM BELOW AS A GUIDE AS TO WHERE YOU MIGHT INSTALL YOUR CHIMNEY.

2: AFTER INSTALLING THE CHIMNEY MOUNTING BLOCK, PLACE THE CHIMNEY ASSEMBLY ON THE ROOF SO THAT THE INSIDE OF THE BACK WALL RESTS AGAINST THE BLOCK.

3: FASTEN THE CHIMNEY TO THE CHIMNEY MOUNTING BLOCK WITH A 2" WOOD SCREW IN EACH SIDE.

