



Escapade

ASSEMBLY MANUAL

Copyright © 2010 PlayNation Play Systems, Inc.

All Rights Reserved

www.PlayNation.com • 190 Etowah Industrial Court • Canton, GA 30114 • (800) 661-7295

Latest Revision: January 31, 2011

TABLE OF CONTENTS

Warranty and Safety Guidelines.....	Pages 3-10
Leveling Fort, General Information and Site Plan.....	Pages 10-14
Kit Contents and Tool List.....	Page 15
Hardware, Lumber Checklist and Accessory Checklist.....	Pages 16-29
Corner Post Layout and Adding T-Nuts to Corner Post.....	Steps 1-2
Framing Fort.....	Steps 3-8
Attaching Deck Spacers, Deck Stringer, Face Boards.....	Steps 9-11
Ladder Assembly and Attaching Ladder.....	Steps 12-13
Attaching Deck Boards, Panel Supports, Panel Boards and Panel Slats.....	Steps 14-17
Building and Mounting Rockwall.....	Steps 18-23
Swing Beam Assembly.....	Steps 24-32
Attaching Arched Side Top Boards.....	Step 33
Assembling Roof, Chimney and Dormers.....	Steps 34-36
Sun Burst Assemblies.....	Steps 37-38
Attaching Window Supports and Window Assembly.....	Step 39
Attaching Safety Board and Angle Supports.....	Steps 40-41
Attaching Accessories and Ground Stakes.....	Steps 42-50
Warranty Registration Card.....	Last Page

**PLEASE READ OWNER'S MANUAL CAREFULLY
BEFORE STARTING ASSEMBLY!**

IMPORTANT – PLEASE READ

As fresh lumber acclimates to its new environment, the natural tendencies of the tree can show itself in the form of checks, or “cracks” in the lumber. In almost all cases this is normal and it will not affect the structural integrity of your play set.

Cosmetic defects that do not affect the structural integrity of the product, or natural defects of wood such as warping, checking or any other physical properties of wood that do not present a safety hazard, are not covered by this warranty. Defects that develop because the product is exposed to extreme climate conditions are not covered by this warranty. Defects that develop as a result of faulty or improper installation of the product are also not covered by this warranty.

Most cracks are not warrantable, however if you believe that the integrity of your play set is compromised by this natural occurrence, please follow the warranty claim procedure found at www.playnation.com. Click on the “Customer Care” tab on the left hand side of the page, then click on “Warranty Claim” and follow the instructions.

We appreciate your purchase and know that you will enjoy your play system for many years to come.

IF YOU HAVE MISSING OR DAMAGED PARTS OR NEED ASSISTANCE ASSEMBLING, PLEASE CALL PlayNation Play Systems, Inc. MANUFACTURING DIRECT.(800) 445-7529 FACTORY HOURS – MON.–FRI., 8AM-5PM EST DO NOT RETURN THIS PRODUCT TO THE RETAILER OR CONTACT THE RETAILER DIRECT. THE RETAILER DOES NOT STOCK COMPONENTS. PLEASE RETAIN THESE INSTRUCTIONS FOR FUTURE REFERENCE. KEEP THEM IN A SAFE PLACE WHERE YOU CAN REFER TO THEM AS NEEDED.

CONTACT INFO:

PlayNation Play Systems, Inc.
190 Etowah Industrial Court
Canton, GA 30114
Tel. (770) 704-9300
Fax. (678) 880-3300
custsrv@playnation.com

Check for revised instructions at www.playnation.com/instructions.html

Thank you for choosing PlayNation Play Systems, Inc.

We've included everything you need, except tools, to build your very own professional looking play set. When complete, your new play set should far exceed the quality of play set kits from other build-your-own companies. Our engineers and design team have over 30 years of playground experience. What we've developed is a play set that doesn't compromise quality for simplicity. Yet you'll appreciate how quick and easy construction really is! Our play set kits are designed for children ages 3 to 11. PlayNation Play Systems, Inc. believes every child should have a play set and with our kits they can! You can rest assured your new play set is safe, durable and designed to hold up to the elements. As parents ourselves, we know how important the security and well-being of our children is, and this shows in all of our products.

Each play set features our step-by-step 3D illustrated manual, patented powder coated swing beam bracket, heavy-duty swing belts with chains, slide(s), accessories, plus all the required hardware and pre-milled lumber.

Limited Manufacturers Warranty

PlayNation Play Systems, Inc. (“PlayNation”) warrants its play sets to be free from defects in workmanship and materials, under normal use and conditions at its original installation, for 10 years for structural wood components and for one year for all other components (e.g., hardware, plastics, tarps, rope ladder, etc.)

Cosmetic defects or natural defects of wood (e.g., warping, seasonal checking or cracking, knots, or knot holes, etc.) that do not affect the structural integrity of the product are not covered by this warranty. Defects that develop because the product is exposed to extreme climate conditions, or that develop as a result of faulty or improper installation of the product, are not covered by this warranty. Fading or discoloration of any part or accessory, cracks in plastic components, surface rust on hardware, and chips on powder coated materials are not considered defects in material as long as they do not affect the functionality or structural integrity of the part or component.

It is the owner’s responsibility to properly maintain the play set. Instructions for proper maintenance can be found on PlayNation’s website. Imperfections or defects that develop because of a failure to properly maintain the play set are not covered by this warranty.

PlayNation will repair or, at its discretion, replace any part within the stated warranty period that is defective in workmanship or materials. This decision is subject to verification of the defect, which, at PlayNation’s discretion, may be accomplished by submitting photographs or by delivery of the defective part to PlayNation. Any warranty claim must include proof of purchase, including the date of purchase.

This warranty is valid only if the product is used for the purpose for which it was designed and installed at a residential, single-family dwelling. This warranty is void if the product is used for commercial, institutional or multi-family dwelling use. This warranty does not cover (a) products that have been damaged by acts of God, negligence, misuse, or accident, or that have been modified or repaired by unauthorized persons; (b) the cost of labor; or (c) the cost of shipping the product, any part, or any replacement product or part.

PLAYNATION DISCLAIMS ALL OTHER REPRESENTATIONS AND WARRANTIES OF ANY KIND, EXPRESS, IMPLIED, STATUTORY, OR OTHERWISE, INCLUDING THE IMPLIED WARRANTIES OF MERCHANTABILITY AND FITNESS FOR A PARTICULAR PURPOSE. PLAYNATION WILL NOT BE LIABLE FOR ANY INCIDENTAL OR CONSEQUENTIAL DAMAGES. This warranty is valid only in the United States of America, is nontransferable and does not extend to the owners of the product subsequent to the original purchaser, and only applies to the product as originally installed (in other words, installing the product and then later disassembling and reinstalling the product at the same or another location voids the warranty). Some states do not allow limitations on implied warranties or exclusion of incidental or consequential damages, so these restrictions may not be applicable to you. This warranty gives you specific legal rights. You may also have other rights which vary from state to state.

Important Safety Guidelines

This product is intended for residential use only and not intended for use in any public setting. A safety surface such as mulch or recycled tire should be used under the play set to prevent injury from falls. Also a 6 foot safety zone should be used around the entire play set.

As with any home project, good judgment and respect for power tools will greatly reduce the risk of injury. PlayNation recommends you follow all tool manufacturers' safety guidelines. Always wear eye protection and safety gloves to prevent injury. In several phases of construction two people may be required for lifting and securing of lumber. While play set is being constructed, please keep children off the equipment until the project is complete. Bolts and screw heads should be checked regularly for tightness. The ground ladder, rope ladder, slide, swings and other areas where children spend a majority of their playtime should be checked more frequently.

PlayNation shall not be liable for incidental, indirect or consequential damages or injuries that result from the building and/or playing on our play sets. Adult supervision is recommended anytime a play set is being used.

WEIGHT LIMITS FOR PlayNation Play Systems

- FORT PLATFORMS: 800 LBS. TOTAL WEIGHT
- SWING BELTS: 175 LBS.
- GLIDER SWINGS: 70 LBS. PER CHILD
- TRAPEZE: 125 LBS.
- FULL BUCKET SWING: 50 LBS.
- TODDLER BUCKET SWING: 50 LBS.
- INFANT SWING: 35 LBS.
- TIRE SWING: 125 LBS. TOTAL WEIGHT
- ROPE LADDER: 75 LBS.
- ROCK WALL: 150 LBS.
- ALL SLIDES: 125 LBS.

PlayNation recommends that the weight limits for all components must not be exceeded. Failure to adhere to these and other safety guidelines could result in damage to the play set and injury to the users.

Safety and Maintenance Tips for Your New Play Set:

NOTE: Your children's safety is our #1 concern. Observing the following statements and warnings reduces the likelihood of serious or fatal injury. Please review these safety rules regularly with your children.

- This play set is designed for the use of 4 occupants who have a combined weight not exceeding 800 pounds on the elevated floor, 3 occupants who have a combined weight of 525 pounds on the swing area, for a total unit capacity of 7 occupants who have a combined weight of 1325. (this weight is not including the picnic table area)
- On-site adult supervision is required.
- Teach children not to walk close to, in front of, behind, or between moving swings or other moving playground equipment.
- Teach children to sit in and never stand on swings.
- Teach children not to twist the chains and ropes and not to loop them over the swing beam, since this may reduce the strength of the chain or rope.
- Teach children not to jump from swings or other playground equipment in motion.
- Teach children not to push empty seats. The seat may hit them and cause serious injury.
- Teach children to sit in the center of the swings with their full weight on the seats.
- Teach children not to use the equipment in a manner other than intended.
- Teach children to always go down slides feet first. Never slide headfirst.
- Teach children to look before they slide to make sure no one is at the bottom.
- Teach children to never run up a slide, as this increases their chances of falling.
- The parents should have the children dress appropriately with well-fitting shoes. Loose clothing such as scarves and ponchos should not be worn. Always take off, tie up or tuck in cords and drawstrings on children's clothing. These things can get caught on playground equipment and strangle a child.
- Teach children not to climb when the equipment is wet.
- Teach children to never jump from a fort deck. They should always use the ladder, ramp or slide.
- Teach children to never crawl or walk across the top of monkey bars.
- Teach children to never crawl on top of a fort roof.
- Verify that any suspended climbing ropes, chains, or cables are secured at both ends.
- Verify climbing ropes are tight enough that they cannot be wrapped around an adult hand.
- Teach children not to attach items to the playground equipment that are not specifically designed for use with the equipment, such as, but not limited to, jump ropes, clothesline, pet leashes, cables and chain as they may cause a strangulation hazard.
- Teach children to never wrap their legs around swing chain.
- Teach children to never slide down the swing chain.

WARNING: Children must NOT use this play set until unit has been completely assembled and inspected by an adult to insure set has been properly installed and anchored.

Safety and Maintenance Tips for Your New Play Set: (continued)

Playgrounds should be inspected on a regular basis. If any of the following conditions are noted, they should be removed, corrected, or repaired immediately to prevent injuries.

- Hardware that is loose, worn or that has protrusions or projections.
- Exposed equipment footings.
- Scattered debris, litter, rocks, or tree roots.
- Splinters, large cracks, and decayed wood components.
- Deterioration and corrosion on structural components, which connect to the ground.
- Missing or damaged equipment components, such as handholds, guardrails, swing seats.
- Check all nuts and bolts frequently during the usage season and tighten as required. (But not so tight that you crack the wood) We recommend you check the swing beam and hardware often due to wood expansion and contraction. It is particularly important that this procedure be followed at the beginning of each season.
- Remove plastic swing seats and take indoors or do not use when the temperature drops below 32°F.
- Oil all metallic moving parts monthly during the usage period.
- Check all coverings for bolts and sharp edges twice monthly during usage season to be certain they are in place. Replace when necessary. It is especially important to do this at the beginning of each new season.
- Check swing seats, ropes, cables and chains monthly during usage season for evidence of deterioration. Replacement should be made of any swing seat that has developed cracks in the plastic seats or has exposed metal in the edges of the swing seat. If there are already exposed metal inserts on the edge of the seat, immediately remove the seats and chains to prevent serious injury. Ropes, cables and chains should be removed and replaced if excessive wear is found. Contact PlayNation for warranted replacement parts.
- For rusted areas on metallic members such as monkey bars, hand supports brackets, etc.; sand and repaint, using a non lead-based paint meeting the requirements of Title 16 CRF Part 1303.
- Inspect wood parts monthly. The grain of the wood sometimes will lift in the dry season causing splinters to appear. Light sanding may be necessary to maintain a safe playing environment. If you are treating your play set with stain regularly, it will help prevent severe checking/splitting and other weather damage.
- Once or twice a year, depending on your climate conditions, you must apply some type of protection (sealant) to the wood of your unit. Prior to the application of sealant, lightly sand any “rough” spots on your set. Please note this is a requirement of your warranty.
- Creating and maintaining the play set on a level location is very important. As your children play, your play set will slowly dig its way into the soil, and it is very important that it settles evenly. Make sure the play set is level and true once each year or at the beginning of each play season.
- Rake the playground surface periodically to prevent compaction and maintain appropriate depths. Disposal Instructions: When the play set is no longer desired, it should be disassembled and disposed of in such away that no unreasonable hazards will exist at the time the unit is discarded.

Play Set Surfacing Recommendations:

Below are some of the recommendations that the U.S. Consumer Product Safety Commission (CPSC) offers from its *Handbook for Public Playground Safety*. The guide can be downloaded in full at www.cpsc.gov/cpscpub/pubs/325.pdf

1. Protective Surfacing - Since almost 60% of all injuries are caused by falls to the ground, protective surfacing under and around all playground equipment is the most critical safety factor on playgrounds.

Certain manufactured synthetic surfaces also are acceptable; however, test data on shock absorbing performance should be requested from the manufacturer.

Asphalt and concrete are unacceptable. They do not have any shock absorbing properties. Similarly, grass and turf should not be used. Their ability to absorb shock during a fall can be reduced considerably through wear and environmental conditions.

Certain loose-fill surfacing materials are acceptable such as the types and depths shown in the table.

Fall Heights and Recommended Materials

Type Of Material	6 in. depth	9 in. depth	12 in. depth
Double-Shredded bark mulch	6' Fall Height	10' Fall Height	11' Fall Height
Wood Chips	6' Fall Height	7' Fall Height	12' Fall Height
Fine Sand	5' Fall Height	5' Fall Height	9' Fall Height
Shredded Tires*	10-12' Fall Height	n/a	n/a
Fine Gravel	6' Fall Height	7' Fall Height	10' Fall Height

*This data is from tests conducted by independent testing laboratories on a 6-inch depth of uncompressed shredded tire samples produced by four manufacturers. The tests reported critical heights, which varied from 10 feet to greater than 12 feet. It is recommended that persons seeking to install shredded tires as a protective surface request test data from the supplier showing the critical height of the material when it was tested in accordance with ASTM F1292.

It should be recognized that all injuries due to falls cannot be prevented no matter what surfacing material is used.

2. Fall Zones - A fall zone, covered with a protective surfacing material, is essential under and around equipment where a child might fall. This area should be free of other equipment and obstacles onto which a child might fall. Stationary climbing equipment and slides should have a fall zone extending a Minimum of 6' in all directions from the perimeter of the equipment.

Swings should have a fall zone extending a minimum of 6' from the outer edge of the support structure on each side. The fall zone in front and back of the swing should extend out a minimum distance of twice the height of the swing as measured from the ground to the top of the swing support structure.

Leveling Your Fort During Assembly

- Complete the steps which will be the basic frame of the fort {i.e. four corner posts with base (sand box boards) and deck supports}
- Position in the most level area chosen for the play set, keeping in mind the location and size of the swing beam, ladder, slides, etc. that extend off the fort.
- Once the frame is in the final position, check for vertical and horizontal levelness to determine which side(s) will need to be dug into the ground to level the play set.
- With a shovel, score the ground around the outside edges of the sandbox boards on the 'high' side of the fort. This is the area that will be dug in. Make sure to score deep enough; the scored lines will be your digging template.
- Push the frame off and away from the scored area, far enough to dig and remove dirt to reach the appropriate depth.
- Dig a channel along the scored line(s) for the base of the fort (corner post and sandbox boards) to rest into. Dig the channel(s) to the same level depth. The bottom of the channel(s) should be level to each other so your frame doesn't teeter or rock because the channel(s) are uneven.
- Once you have removed enough grass and dirt, slide/push the frame into the channel(s). Place a level on the vertical and horizontal boards of the frame to determine if enough soil, or too much, was removed.
- Repeat this process until the basic frame is plumb and level and in its final position before completing the rest of the assembly.
- Measure diagonally make sure fort is square.

Important: if you require a channel depth of more than 6", then we recommend you have your play set area professionally graded before completing assembly.

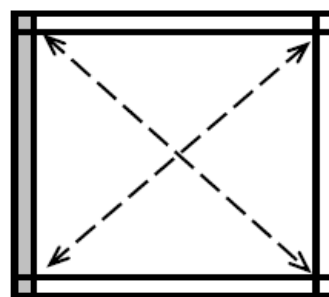
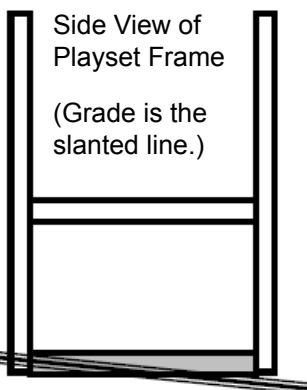

Top View of Playset Frame showing diagonal measurements.

THE DIAGONAL MEASUREMENTS SHOULD BE THE SAME FROM CORNER POST TO CORNER POST. IF NOT, ADJUST FORT SO THAT THE DISTANCE IS EQUAL.

■ = AREA TO BE SCORED AND CHANNELLED FOR LEVELNESS

General Info to Review Before Installation

- Depending on your experience, assembly of PlayNation Playsets can take as little as 6 hours up to 24 hours, depending on size, after inventory of parts; therefore, we recommend you set aside a full two days for assembly.
- Identify all of the parts for your play set. Empty each box and lay out boards so you can see each part. Your instruction book will have detailed drawings that will make it easy for you to recognize individual parts. Keep all hardware and metal parts separate from wooden pieces.
- After everything is laid out, check carefully to ensure all parts are present. Make sure there are no broken boards.
- Find an area to sort your hardware. It is best to open the hardware on a solid surface so that you do not lose any pieces in the grass. This will save time and familiarize you with all the different pieces in the hardware bag.
- Important note: Wood has some natural defects such as knots, surface cracks, etc... We reject parts that are structurally defective. We use a high quality lumber in our structures; however, you should inspect each part for splinters or rough spots and sand them smooth to prevent injury.
- After familiarizing yourself with all of the components, read all instructions thoroughly. Reading instructions after you have studied the parts will help you understand more clearly the installation process, and help to eliminate unnecessary mistakes.
- Pay close attention to the diameter and length of each bolt and screw.
- Never tighten hardware completely at first. It helps to have some adjustment for bolt alignment while you are attaching parts together. After everything is square, tighten each joint.
- After the main unit is assembled it is critical that the floor is **level** and **square**. If the main frame is not level, the walls and floor will be out of square.
- After you complete installation, make sure every bolt, screw, and nut is tight, and every board is secure. Wood will expand and contract with the seasons.
- Check all bolt connections and swing hangers seasonally.
- Place the set on level ground, not less than 6ft from any structure or obstruction such as a fence, garage, house, overhanging branches, laundry lines, or electrical wires.

This page is a list of definitions and explanations used throughout our instructions to aid you in the assembly of your play set.

Offset Holes- Throughout the installation procedures we will refer to parts with offset holes. This refers to the orientation of the holes on the board. An offset hole is one that is closer to one side than it is to the other or in other words, it is not centered on the board. In the procedures you will be instructed to attach the boards with the holes “offset up” or with the holes “offset down”. This refers to which side of the board the hole/holes should be closer to. Offset Holes Up= hole/holes will be closer to the top of the board. Offset Holes Down= hole/holes will be closer to the bottom of the board. Note: some parts do not have offset holes, but instead the holes are on center. Therefore there will not be any reference to how to offset these parts.

EXAMPLE OF OFFSET HOLES DOWN

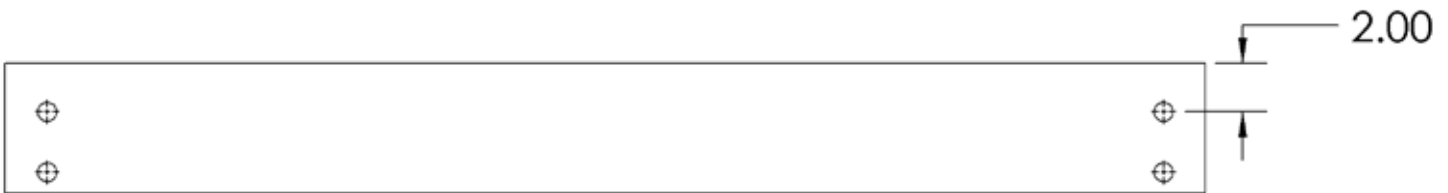

EXAMPLE OF OFFSET HOLES UP



Counter-sunk holes- Many of the parts that will be used have counter-sunk holes. A counter-sunk hole is one that surrounds one side of a thru hole, but does not extend through the wood itself. When using a counter-sunk hole the bolt will be inserted through the thru hole. In some cases the bolt head with a washer will occupy the counter-sunk hole. In other cases a nut with a washer will occupy the counter-sunk hole.

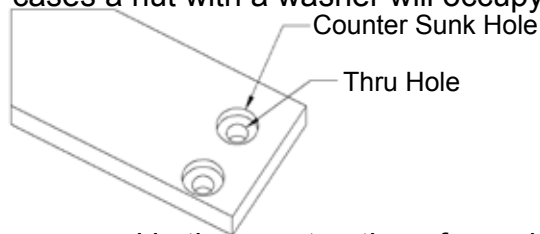

Lag Screws- Lag screws are used in the construction of our play sets to enhance the structural integrity of the unit. There will not be predrilled holes in the post for lag screw installation. Lag screws are self-tapping, though if you are using a manual socket wrench it may be necessary to tap the head of the lag screw with a hammer. You should also be sure to tighten the lag screws completely. Power tools such as an impact wrench or power drill should have enough torque to drive the lag screws without using a hammer, but make sure not to over tighten as this can cause the threads to “strip out” in the post.

Common Installation Practice Installing T-nuts

When installing T-nuts into the wood, use a smooth faced hammer to set the face of the T-nut flush into the wood

Corner Post

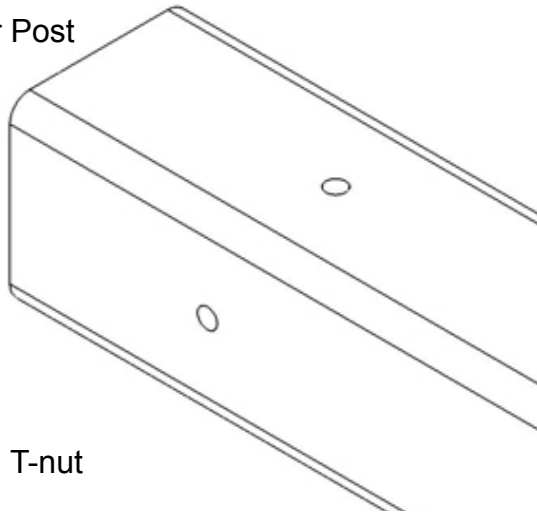

T-nut

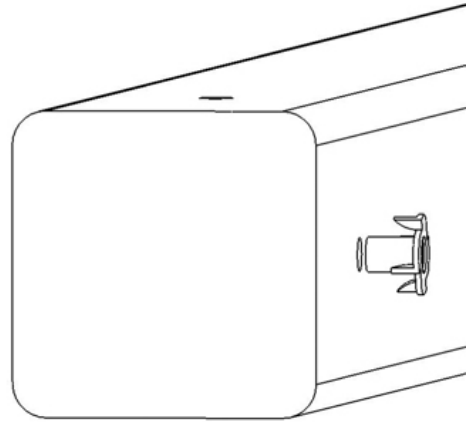

Insert the barrel of the T-nut into the predrilled hole. Using a smooth faced hammer, drive the T-nut until the face of the T-nut is flush to the wood.

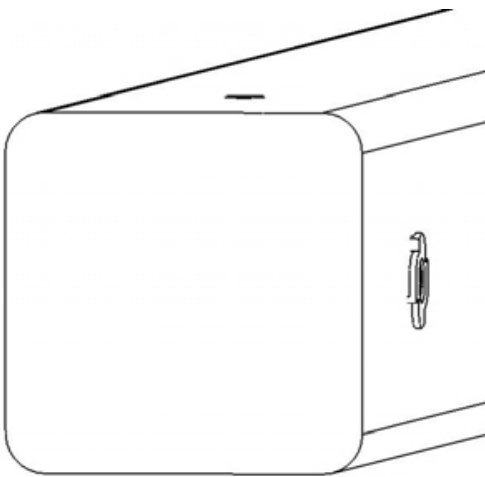

This picture shows the T-nut insert and installed flush to the wood.

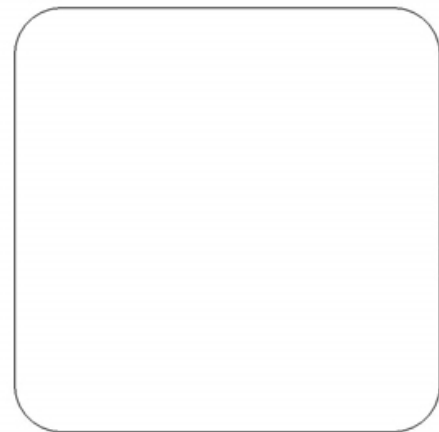

This picture shows an end view of the T-nut insert and installed flush to the wood.

WARNING: DO NOT EMBED THE TOP OF THE T-NUT INTO THE FACE OF THE WOOD

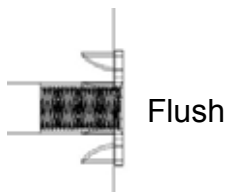

Flush

Cross Section end views, you are looking at an Xray view of the post and T-nut. The barrel of the T-nut is in the corner post. The line is the face of the wood.

Please familiarize yourself with the manual, parts/components and general construction process of your new playset before getting started.

SITE PLAN:

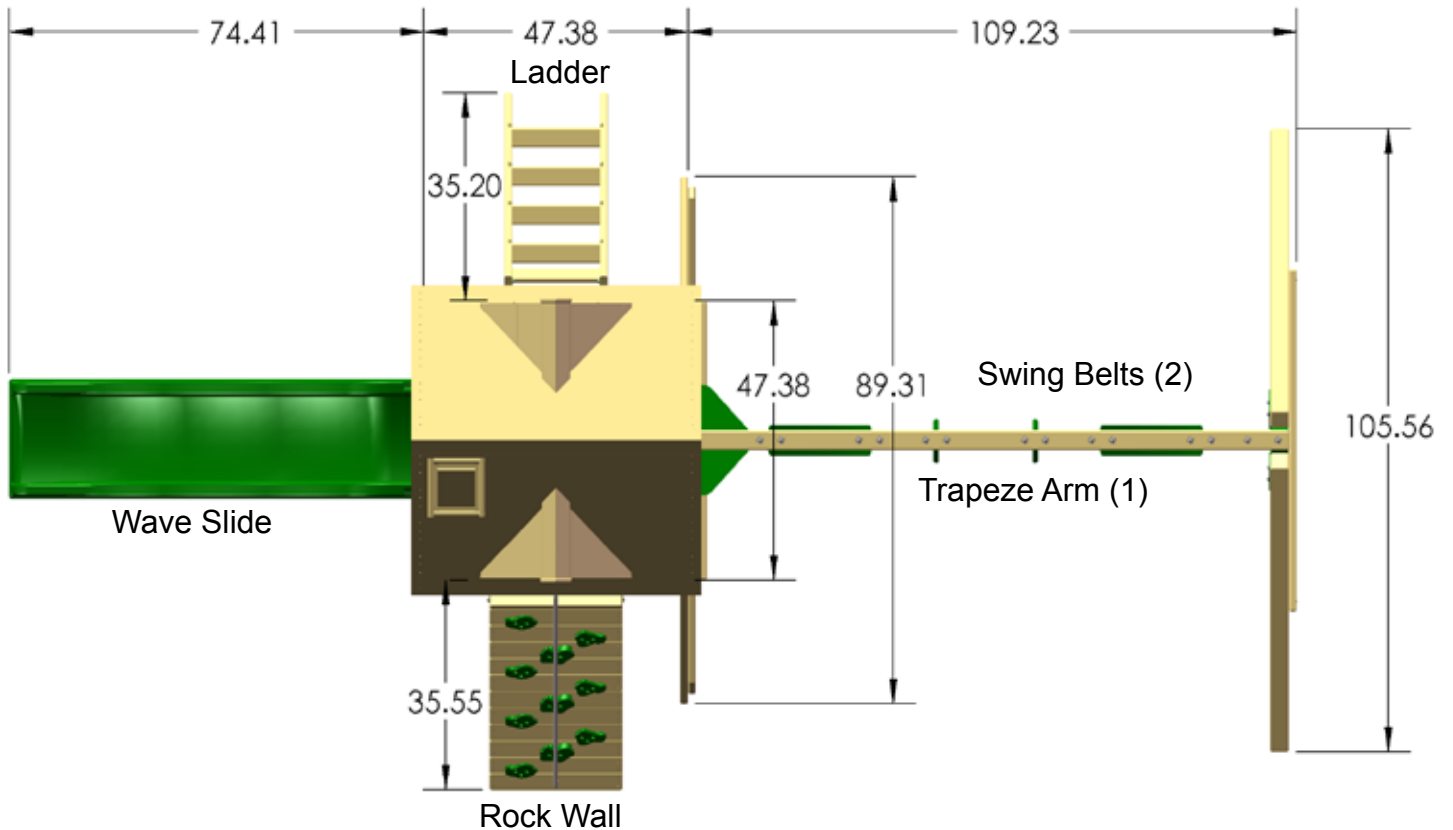

Playset height: 10' - 4-1/2"

Approximate assembly time: 6-8 Hours

(6) foot unobstructed safety perimeter around playset recommended

REQUIRED TOOL LIST

- ___ Standard or Cordless Drill w/ Phillips Bit (#2 square bit provided)
- ___ 1/8" Drill Bit
- ___ 3/8" Drill Bit
- ___ 1/2" Wrench and Socket
- ___ 1/2" Deep Well Socket
- ___ 9/16" Deep Well Socket
- ___ 9/16" Wrench and Socket
- ___ Level
- ___ Tape Measure
- ___ Extension Cord (if using standard drill)
- ___ Hammer
- ___ Pencil
- ___ Locking Pliers (Vise Grips)
- ___ Shovel

KIT CONTENTS

Swings, Slides, Accessories:

- ___ (Qty) Description
- ___ (2) Swingbelts w/ Chains
- ___ (1) 8ft. Wave Slide
- ___ (1) Escapade Assembly Manual
- ___ (10) Rock Wall Grips
- ___ (1) Trapeze Bar w/ Chains
- ___ (1) Telescope
- ___ (1) Steering Wheel
- ___ (2) Safety Handles
- ___ (1) Tic Tac Toe Panel
- ___ (2) Working Plastic Window Shutters
- ___ (4) Ground Stakes
- ___ (1) 10ft Rope
- ___ (2) Flag Kit

Fort Hardware:

see following pages

Wood Components:

see following pages

Swing Beam Hardware:

see following pages

Use the ruler to the right to measure your bolts and screws. Picture views shown below are 1:1 scale and can be used to match bolt and screw sizes.

#8 x 1 1/4"
Wood Screw
QTY: 10



#8 x 1-1/2"
Wood Screw
QTY: 104



#8 x 2"
Wood Screw
QTY: 191



#8 x 2 1/2"
Wood Screw
QTY: 34



#8 x 3"
Wood Screw
QTY: 14



5/16" Tee Nut
QTY: 42



Torque Washer
QTY: 17



3/8" Lock Nut
QTY: 19



3/8" Washer
QTY: 31



5/16" Washer
QTY: 68



5/16 x 4 1/2"
Hex Bolt
QTY: 32



5/16 x 2 1/2"
Hex Bolt
QTY: 2



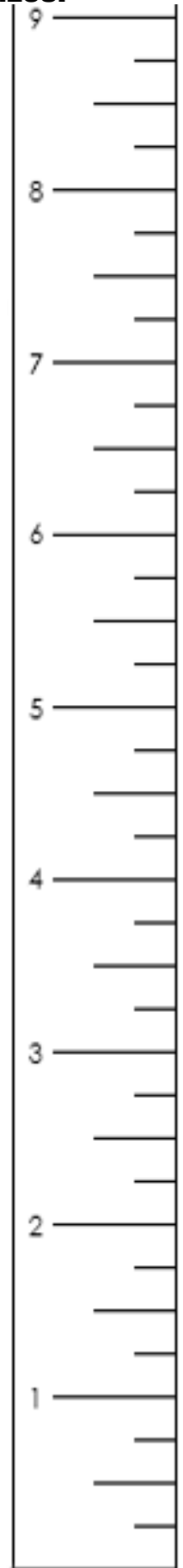

5/16 x 1 1/2"
Hex Bolt
QTY: 8

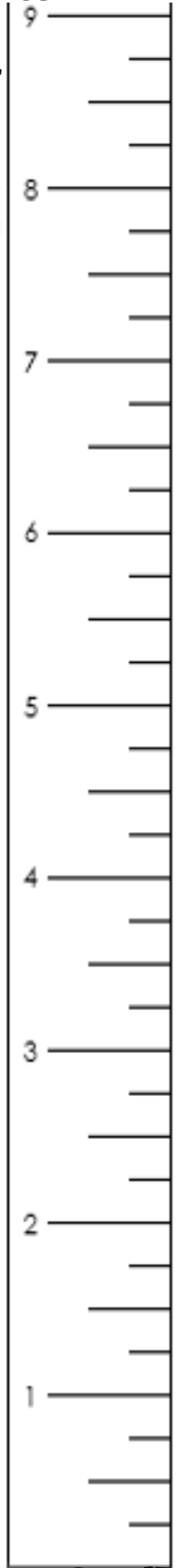
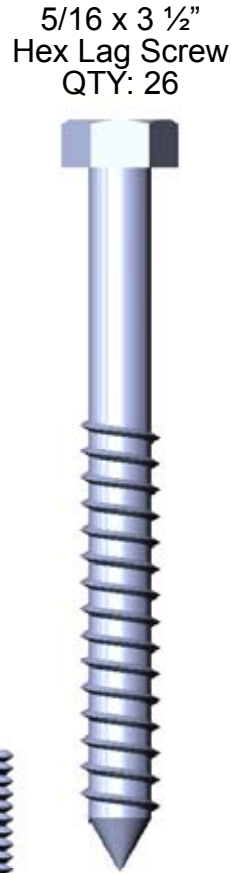
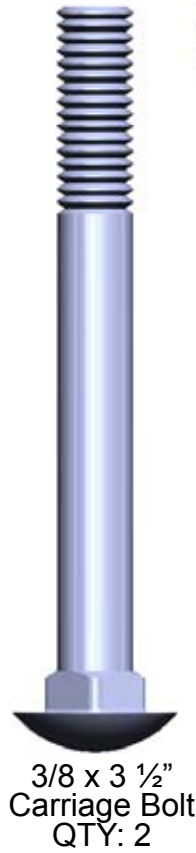
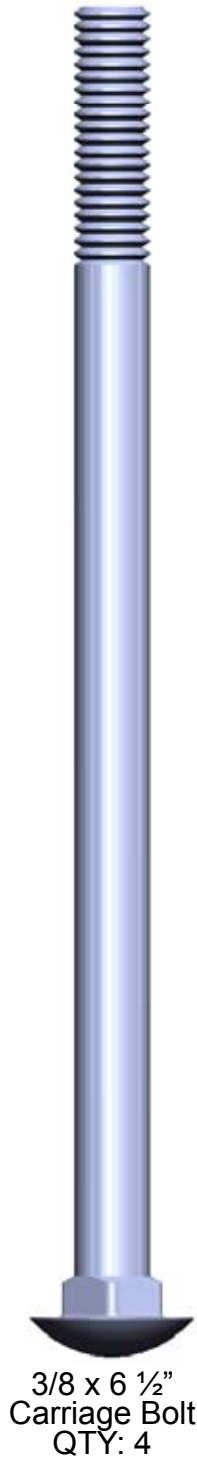
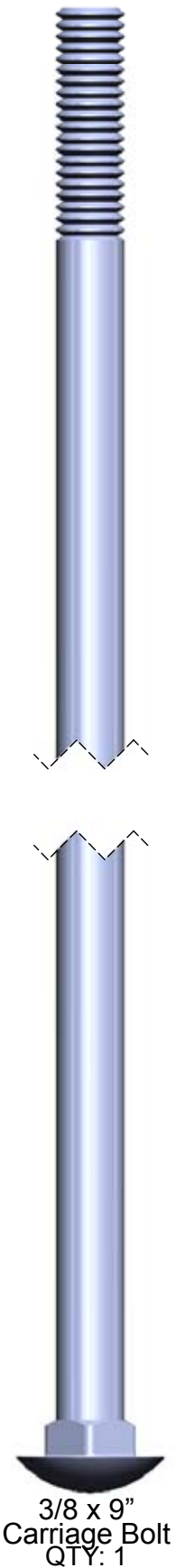

Use the ruler to the right to measure your bolts and screws. Picture views shown below are 1:1 scale and can be used to match bolt and screw sizes.

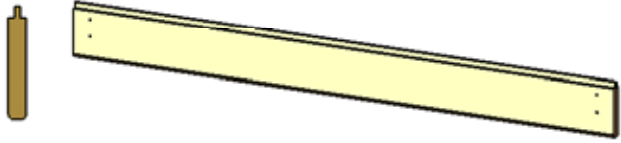
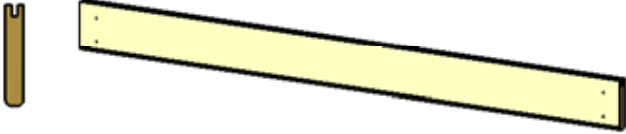

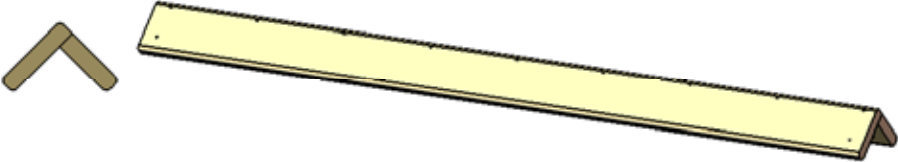
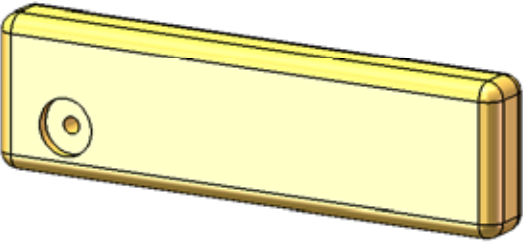
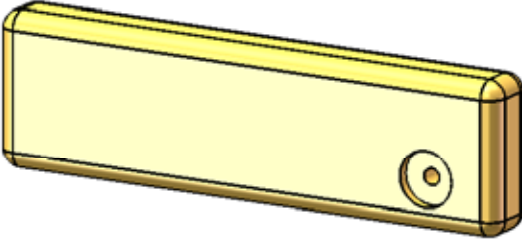
Picture	Description	Qty.
	1 x 5 x 52" Roof Finisher (Tongue Only)	2
	1 x 5 x 52" Roof Starter (Groove Only)	2
	1 x 5 x 52" Roof Board (Tongue and Groove)	14
	3-1/2 x 3-1/2 x 52" Roof Peak	1
	2 x 4 x 12" Bottom Panel Board - Left	3
	2 x 4 x 12" Bottom Panel Board - Right	3

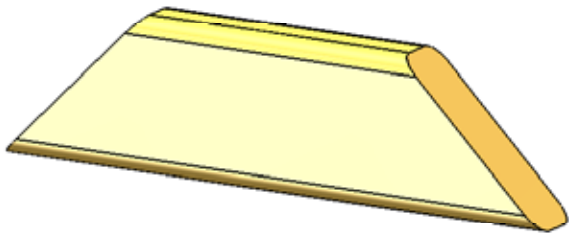
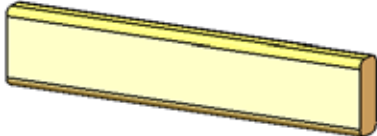
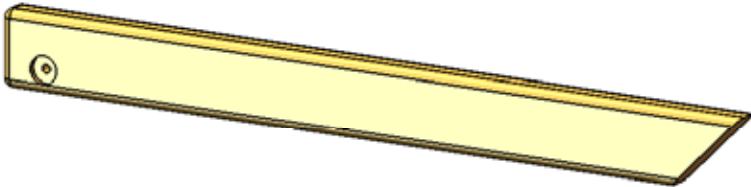
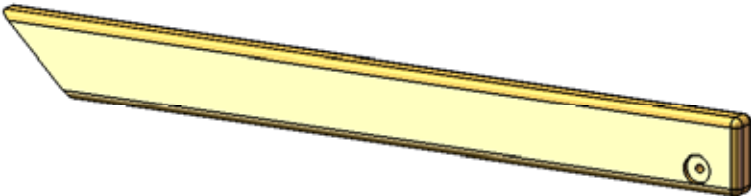
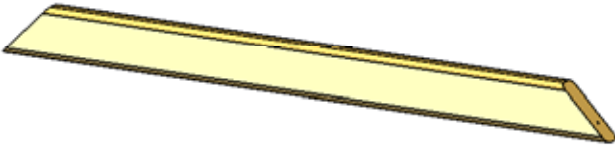
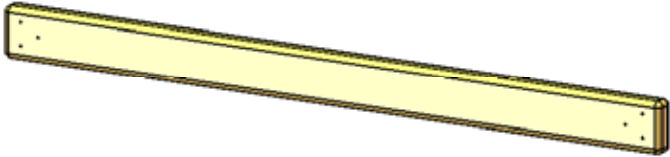
Picture	Description	Qty.
	2 x 4 x 13" Angle Support	8
	2 x 4 x 17" Ladder Step	4
	2 x 4 x 35-1/2" Roof Support - Left	2
	2 x 4 x 35-1/2" Roof Support - Right	2
	2 x 4 x 43-3/4" Sun Support	2
	2 x 4 x 47-3/8" Face Board	2

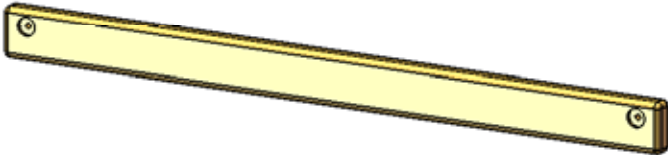
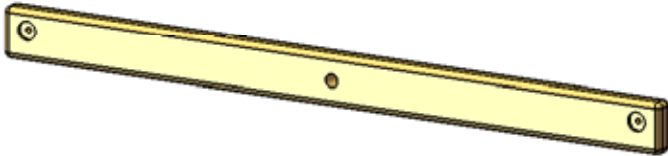
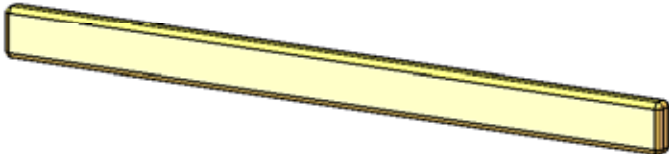
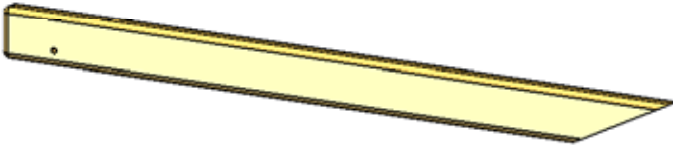
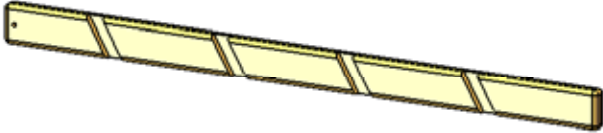
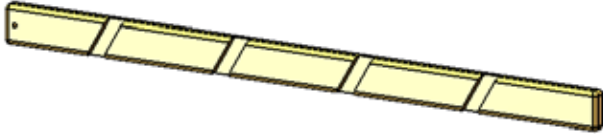

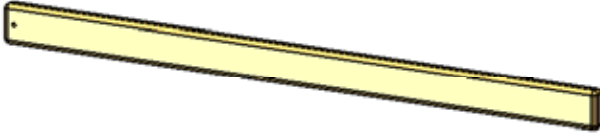
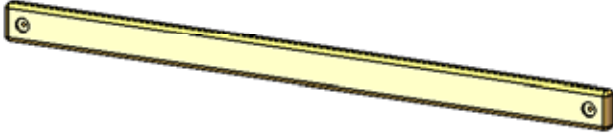
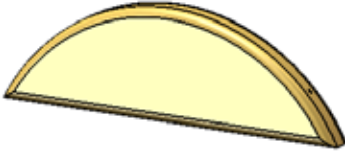
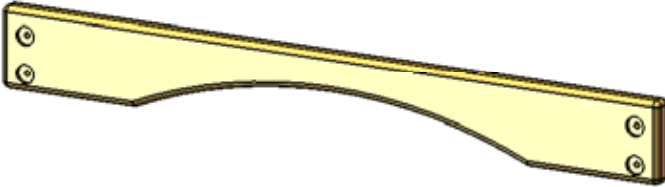
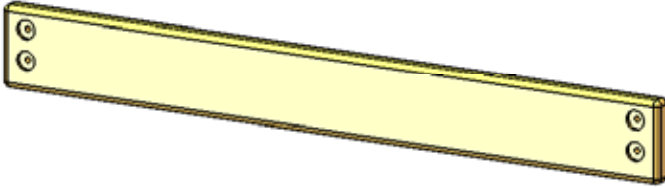
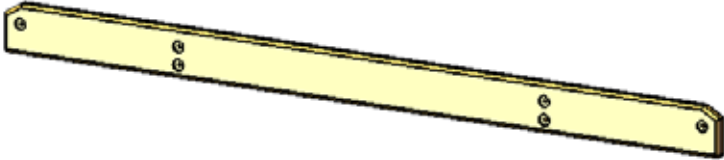
Picture	Description	Qty.
	2 x 4 x 47-3/8" Panel & Deck Support	9
	2 x 4 x 47-3/8" Rock Wall Side Top Panel Board	1
	2 x 4 x 47-3/8" Stringer	1
	2 x 4 x 48" Fort Support	2
	2 x 4 x 57" Ladder Left Side	1
	2 x 4 x 57" Ladder Right Side	1

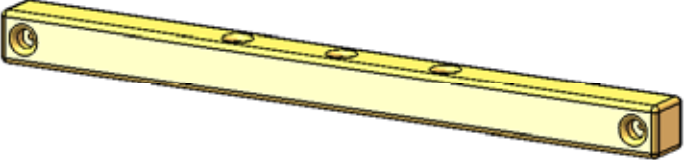
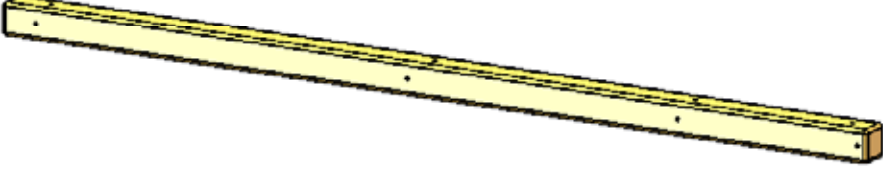
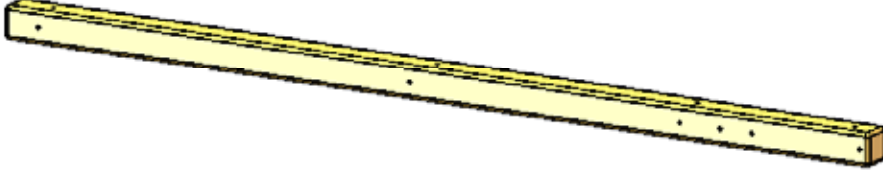
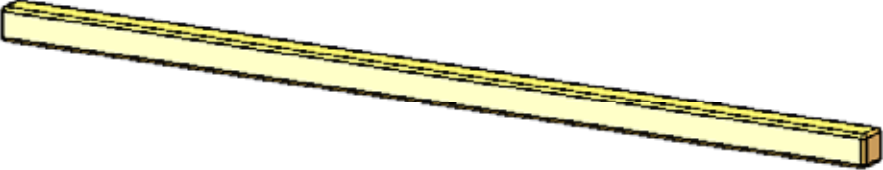
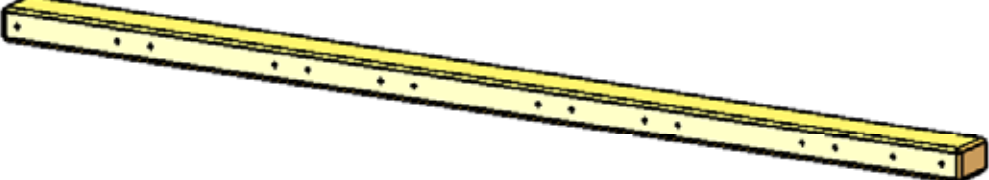
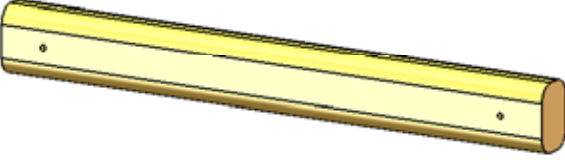
Picture	Description	Qty.
	2 x 4 x 57" Rock Wall Side	2
	2 x 4 x 58" Swing Leg Cross Member	1
	2 x 6 x 16" Sun	2
	2 x 6 x 47-3/8" Arched Side Top Board	2
	2 x 6 x 47-3/8" End Sandbox Board	3
	2 x 6 x 86" Rear Sandbox Board	1

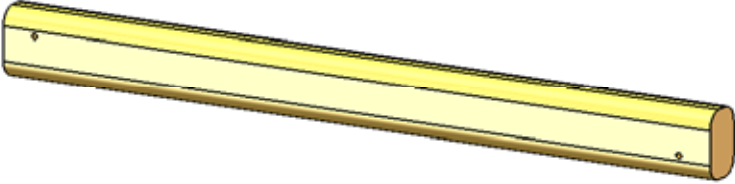
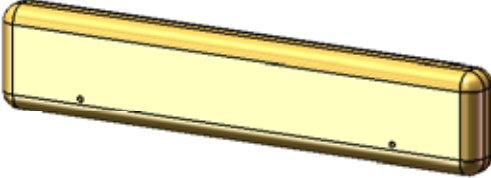
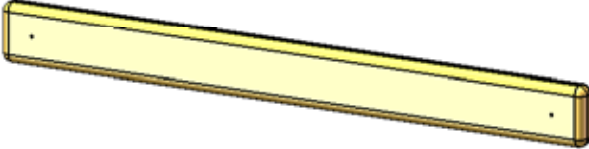
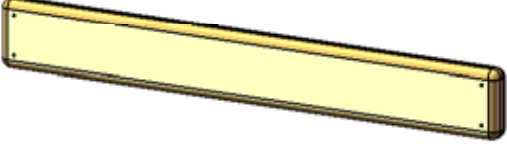
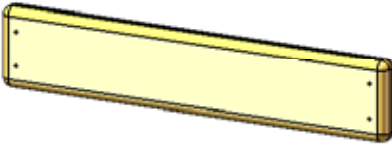
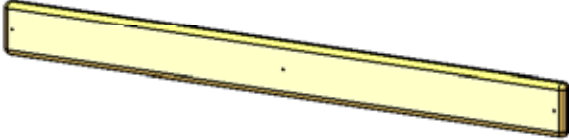
Picture	Description	Qty.
	4 x 4 x 47-3/8" Swing Beam Support	1
	4 x 4 x 96" Front Corner Post	2
	4 x 4 x 96" Rear Corner Post	2
	4 x 4 x 96" Swing Leg	2
	4 x 6 X 108" Swing Beam	1
	5/4 x 2 x 13" Small Ray	12

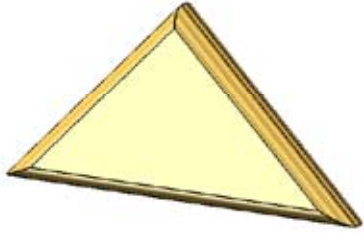
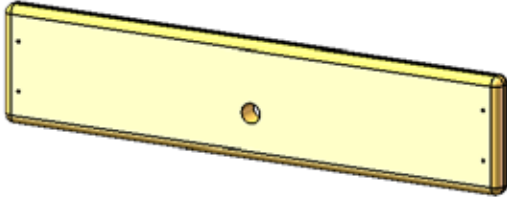
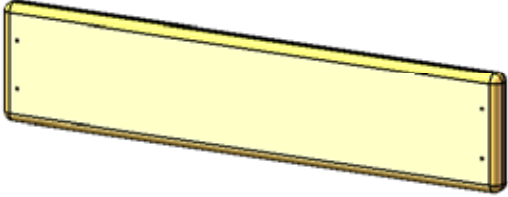
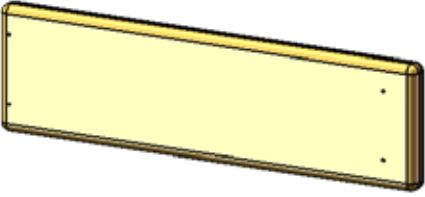
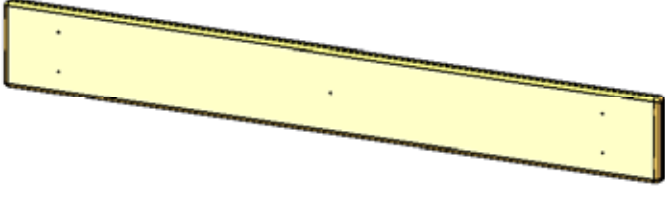

Picture	Description	Qty.
	5/4 x 2 x 17" Large Ray	2
	5/4 x 2-1/4 x 11-1/2" Horizontal Window Support	4
	5/4 x 3 x 28" Panel Slat	19
	5/4 x 3 x 23-7/8" Rock Wall Top Cap	1
	5/4 x 4 x 18-1/2" Ladder Back	1
	5/4 x 4 x 40-1/2" Deck Spacer	2

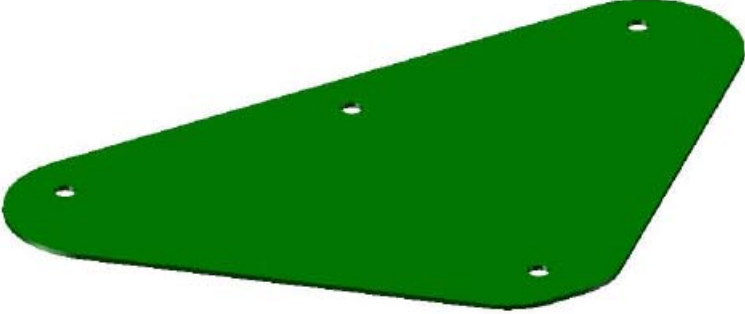
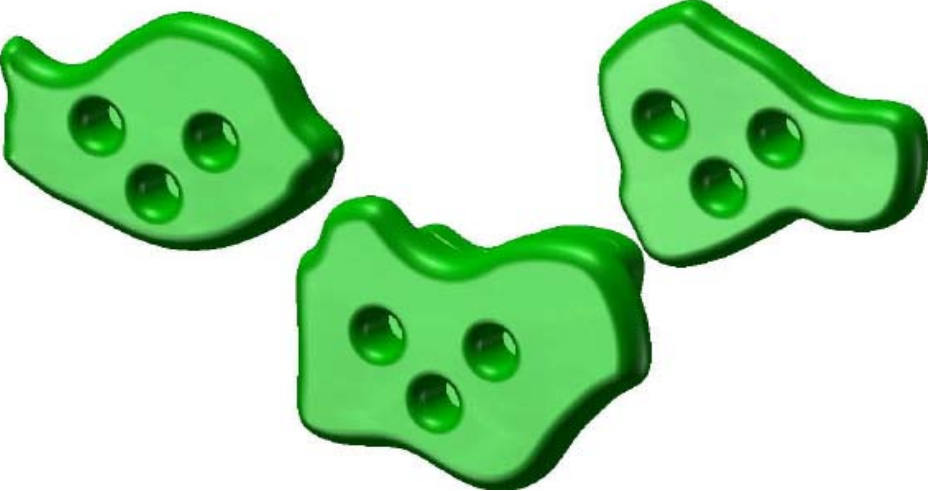
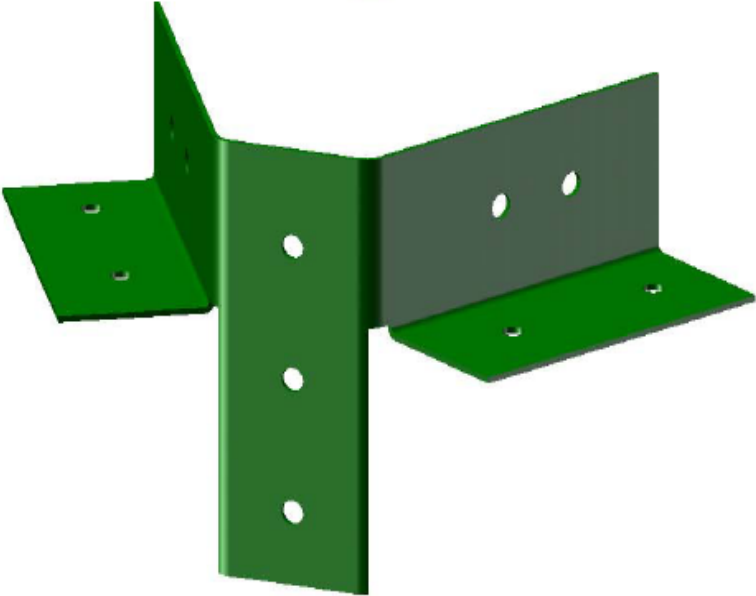

Picture	Description	Qty.
	5/4 x 6 x 10-1/2" Roof Peak Support	2
	5/4 x 5 x 23-7/8" Bottom Rock Wall Board	1
	5/4 x 5 x 23-7/8" Rock Wall Board	10
	5/4 x 6 x 20" Vertical Window Support	3
	5/4 x 6 x 47-3/8" Deck Board	7

Picture	Description	Qty.
	8' Wave Slide	1
	Swings w/Chains Trapeze Bar w/Chains	2 1

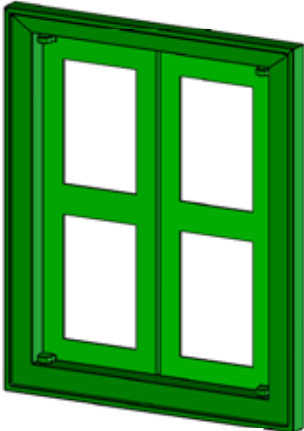
Picture	Description	Qty.
	Swing Plate	1
	Climbing Rocks	10
	A-Frame Swing Leg Bracket	1
<p style="text-align: center;">Not Shown</p>	Hardware Box Instructions	1

Picture	Description	Qty.
	Iron Ductile Swing Hangers	6
	90 ° Green Bracket	4
	Spring Clip	6
	<p>Unassembled Tic Tac Toe panel</p> <p>Tic Tac Toe Boards 1-3/8" x 1-5/8" x 10-1/2"</p>	<p>1</p> <p>2</p>

Picture	Description	Qty.
	10' Rope	1
	Plastic Window	2
	Flag Kit	2
	Ground Stake	4

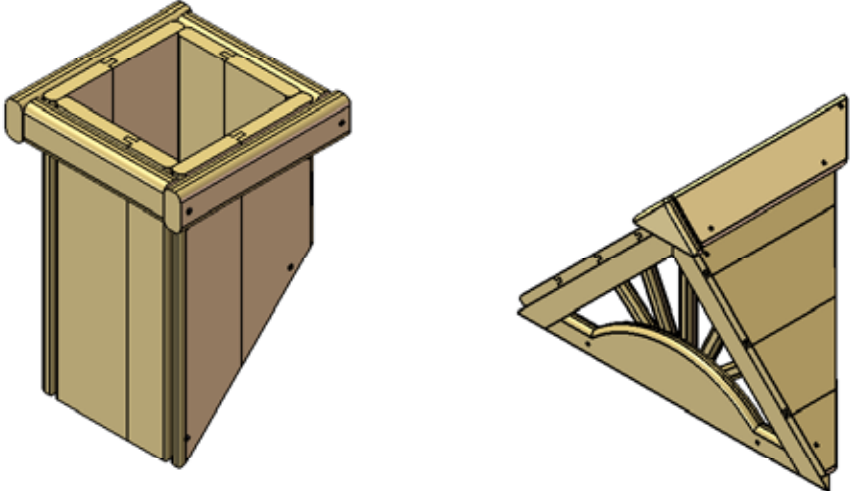
Picture	Description	Qty.
	Telescope	1
	Steering Wheel	1
	Safety Handle	2
	Unassembled Chimney Unassembled Dormer	1 2

Step 1: Corner Post Layout

1: This step is critical to building the fort properly. If any mistakes are made here, you will need to dis-assemble and then re-assemble to make your corrections.

2: Lay out each of the 4 x 4 x 96" Corner Posts in the area you intend on building the fort side of the playset.

3: Use the diagram below to correctly identify and orient the necessary direction the posts should face. Note: the Slide side is considered the front of the playset with the swing beam extending off the rear side.

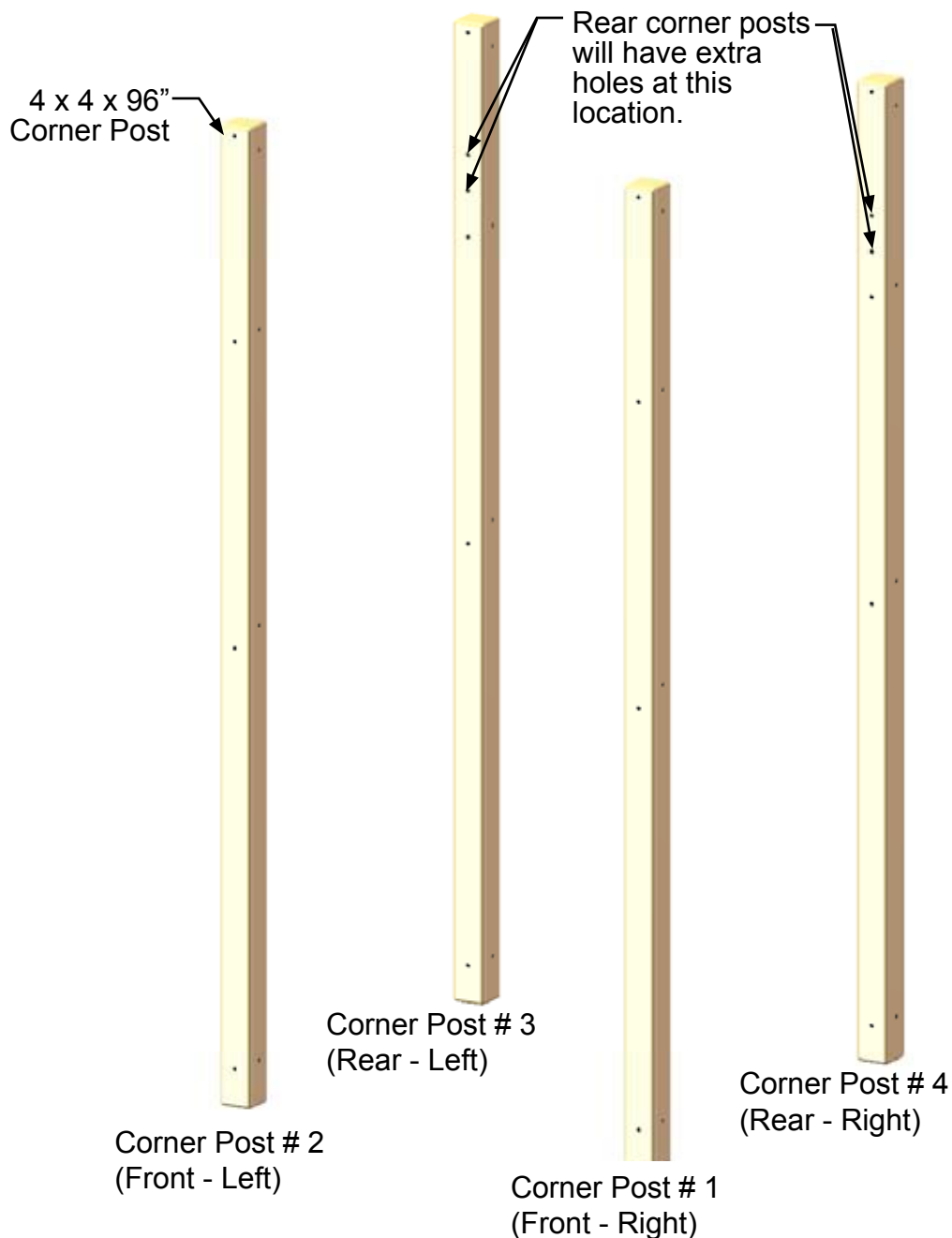

Step 2: Inserting T-Nuts Into Corner Posts

1: Use a hammer to seat the t-nuts after inserting them into the holes shown in the diagram below.

2: The barrel of the t-nut should go in the hole first. Hammer the t-nut until it is flush/ almost flush to the corner posts. No t-nuts will be installed in the Rear Corner Posts where shown below.

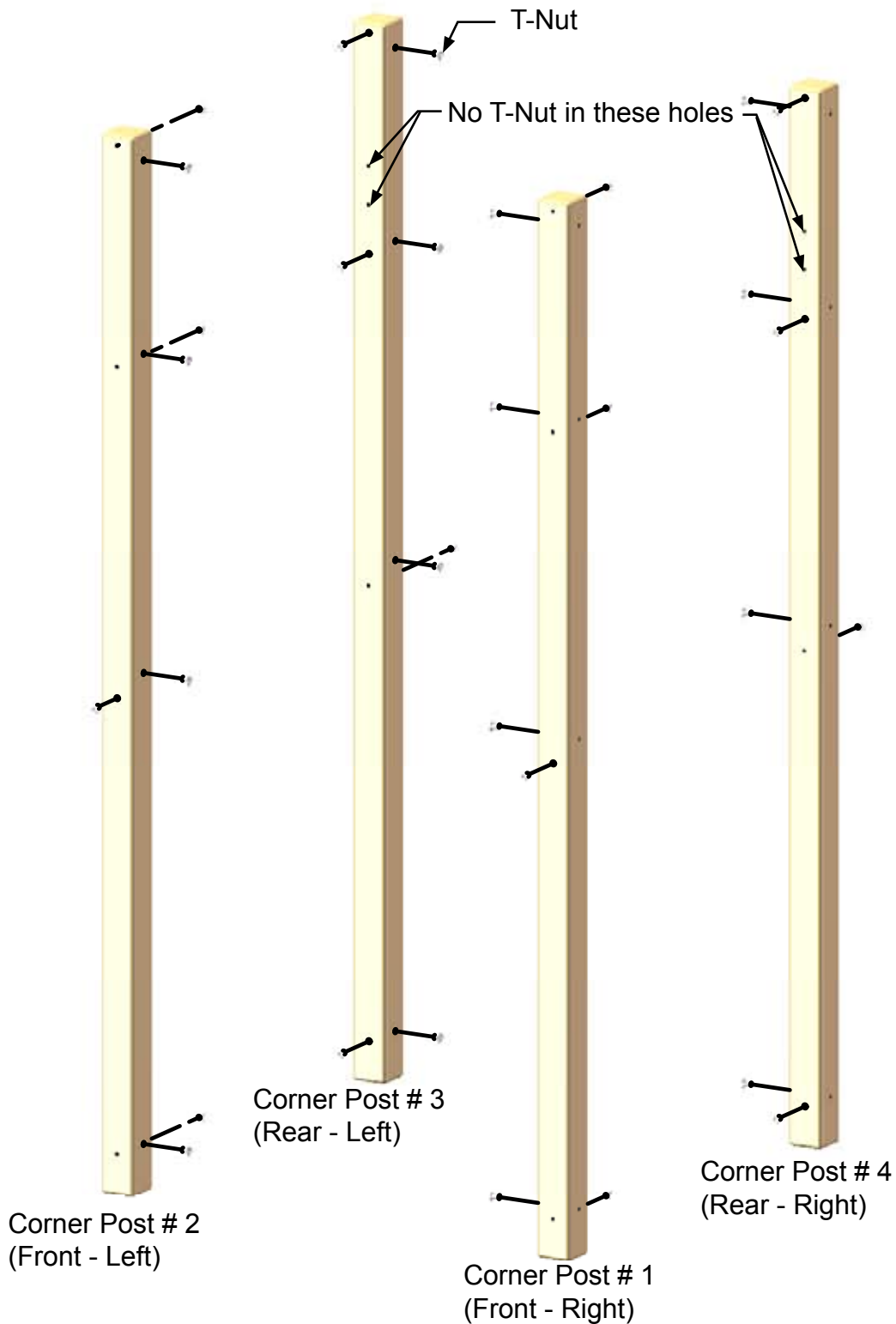

Step 3: Sandbox And Panel Support Board

1: The 2 x 6 x 47-3/8" End Sandbox Board (with four pre-drilled holes) attaches to the bottom of the Front Corner Posts, offset holes down with two 5/16" x 4-1/2" hex bolts and two 5/16" washers.

2: The 2 x 4 x 47-3/8" Panel Support (with two pre-drilled holes) attaches to the front side of the Front Corner Posts, offset holes down, with two 5/16" x 4-1/2" hex bolts and two 5/16" washers.

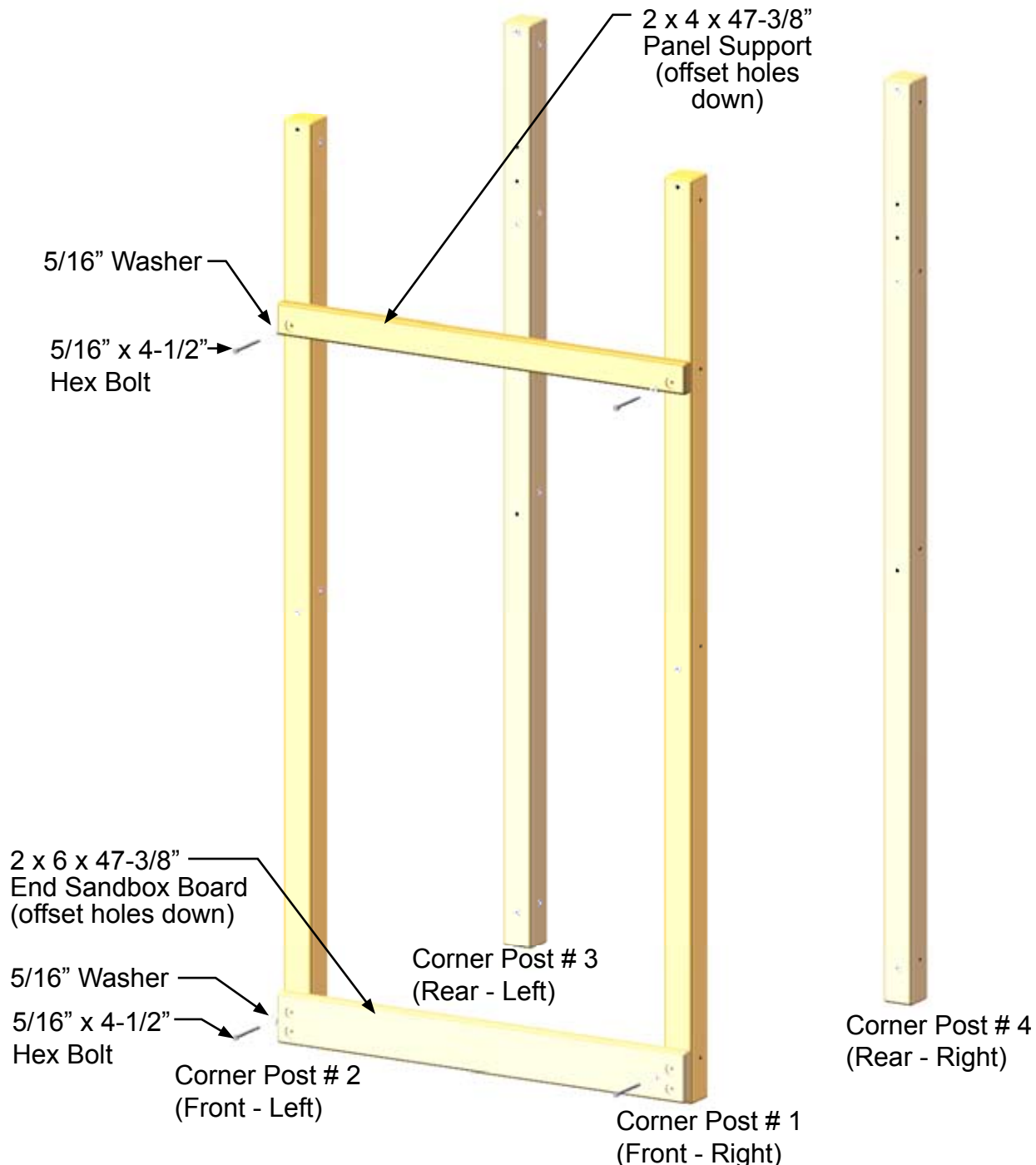

Step 4: Rear Sandbox/Panel Support Board

1: The 2 x 4 x 47-3/8" Panel Support (offset holes down) attaches to the back side of the Rear Corner Posts with two 5/16" x 4-1/2" hex bolts and two 5/16" washers.

2: The 2 x 6 x 86" Rear Sandbox Board (offset holes down) attaches to the back side of the Rear Corner Posts with two 5/16" x 4-1/2" hex bolts and two 5/16" washers into the topmost holes in the Rear Sandbox Board.

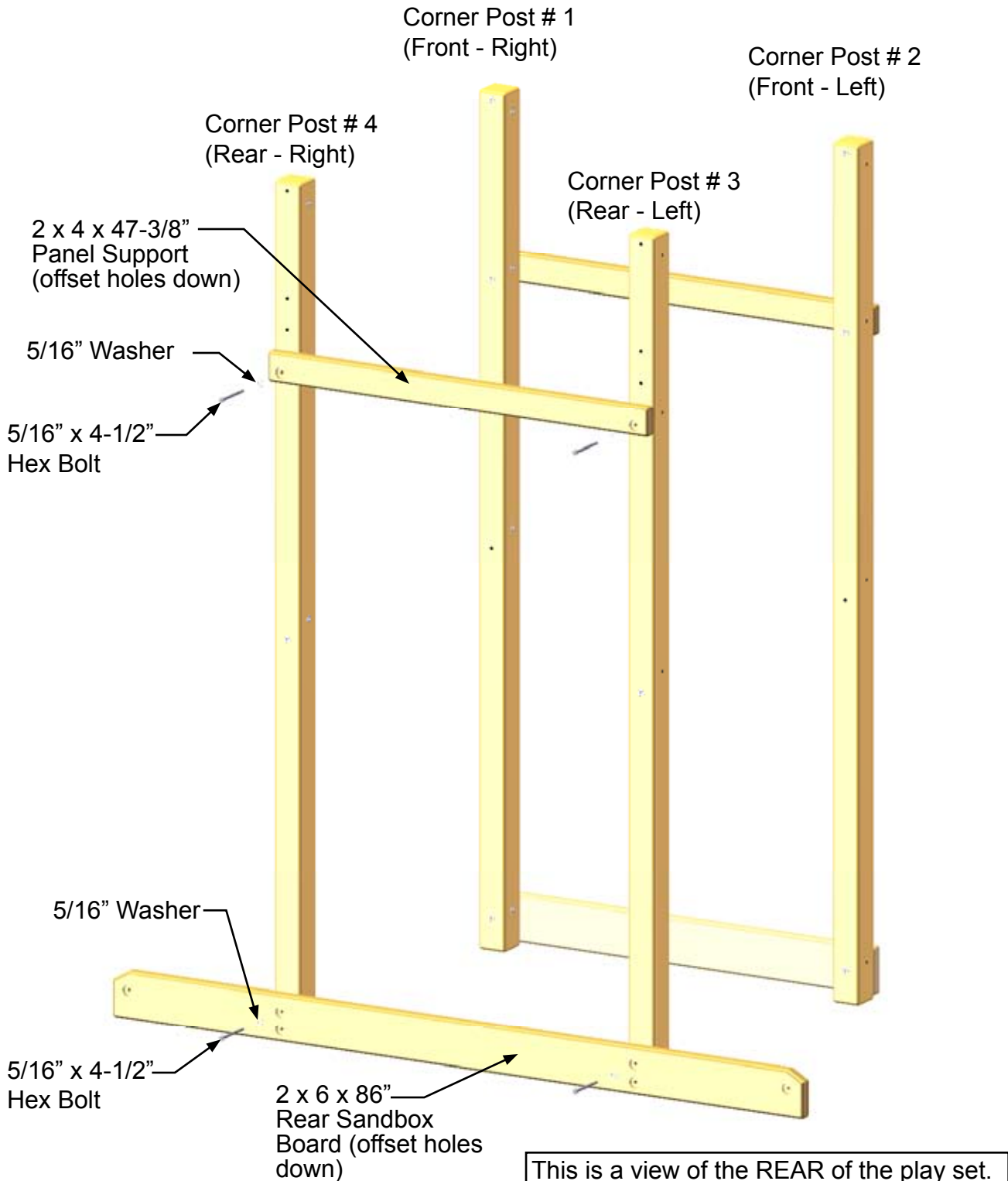

Step 5: Sandbox Boards and Panel Support

1: The 2 x 4 x 47-3/8" Panel Supports (offset holes up) attach to the sides of the front and rear corner posts with two 5/16" x 4-1/2" hex bolts and two 5/16" washers.

2: Attach the top holes in the 2 x 6 x 47-3/8" End Sandbox Boards (offset holes up) to the sides of the front and rear corner posts with two 5/16" x 4-1/2" hex bolts and two 5/16" washers. The structure should be able to stand on its own, without any support, at this stage.

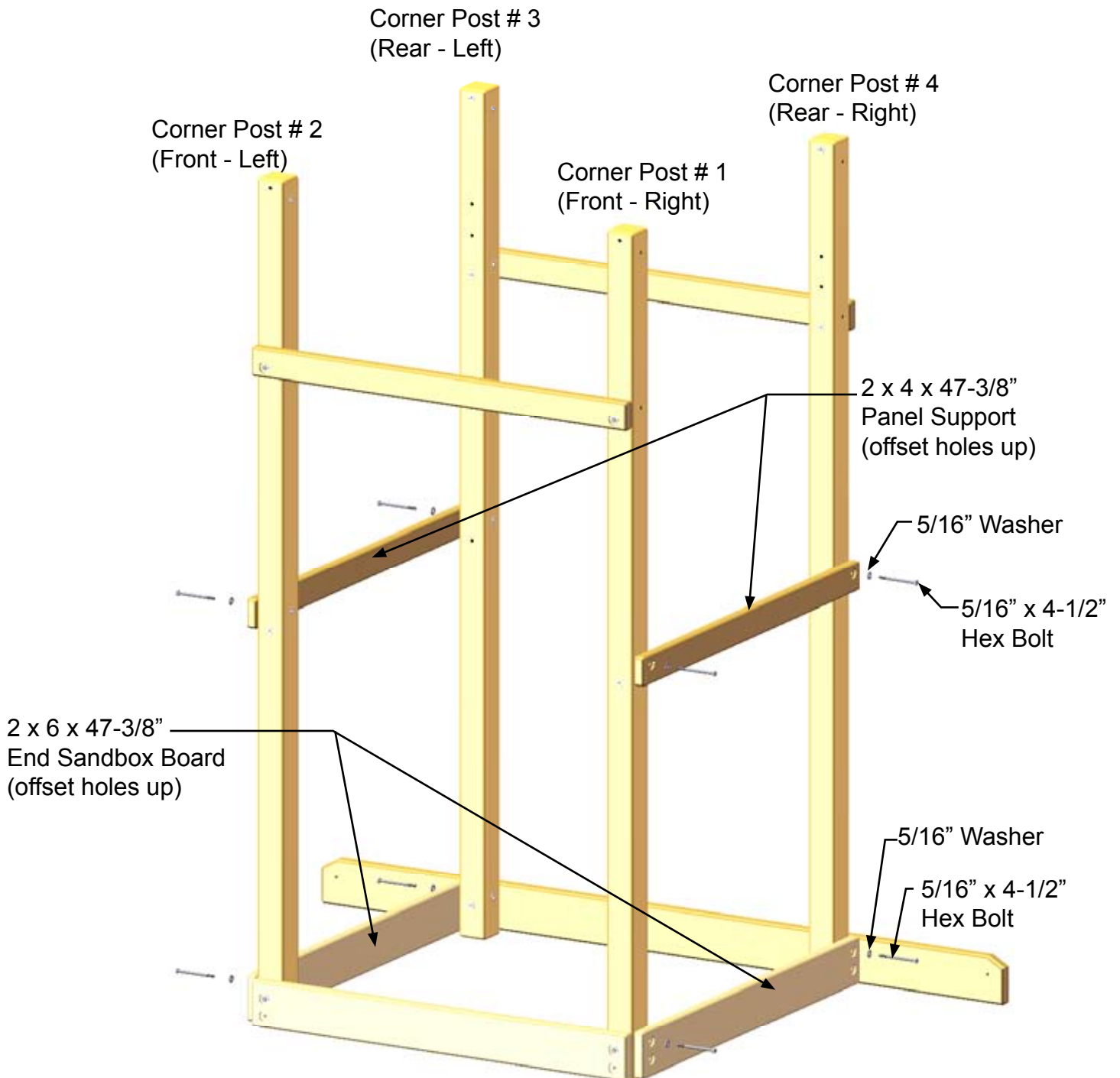

Step 6: Deck Supports

1: Attach one Deck Support (offset holes down) to the inside of the Front and Rear Corner Posts with two 5/16" x 4-1/2" hex bolts and 5/16" washers.

Note: One Panel Support Board was removed for clarity.

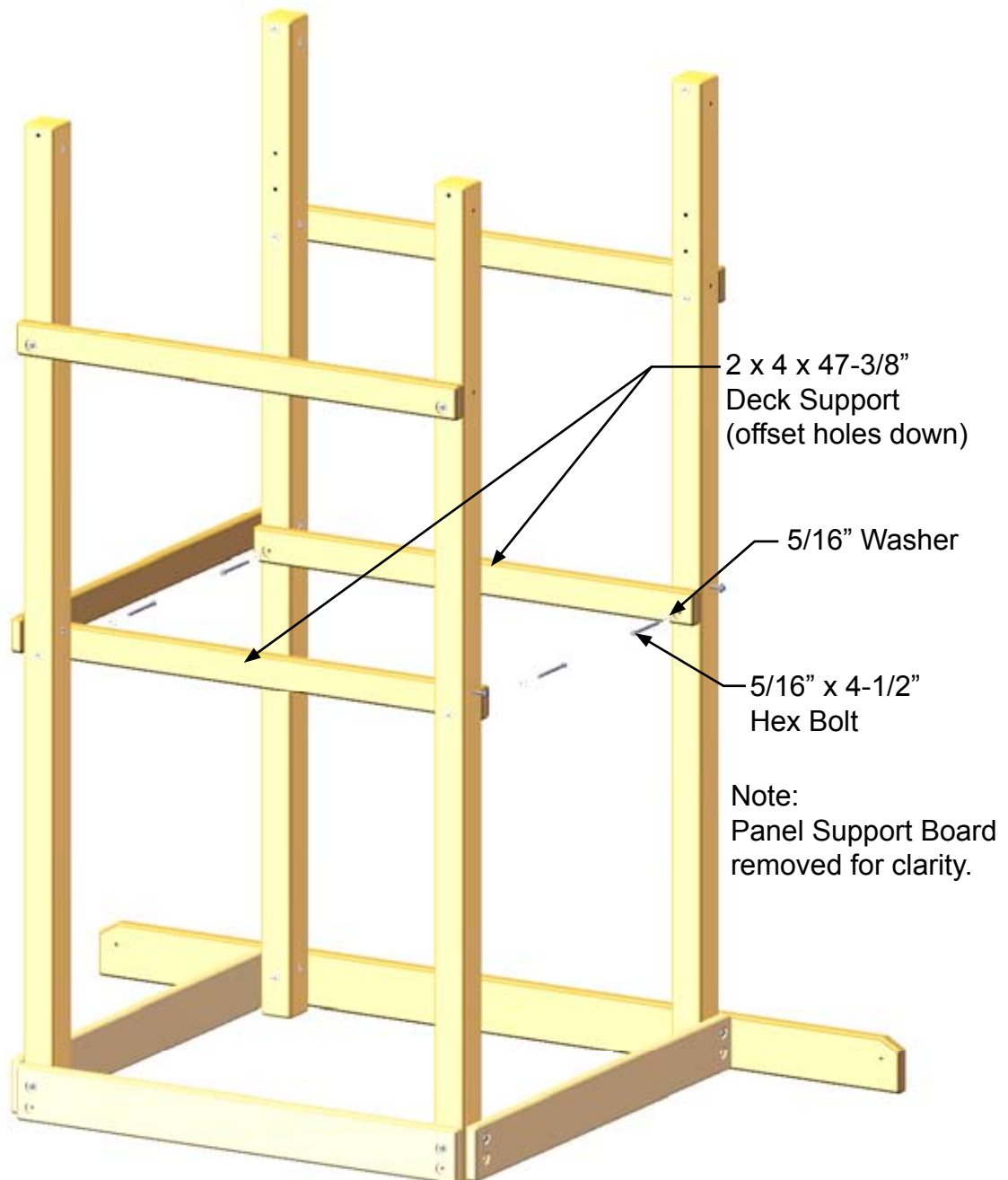

Step 7: Leveling the Play Set and installing Lag Screws

1: Level your play set frame. Level side to side and front to back. Check the diagonals for square. Once you have a level and square play set frame you may install lag screws.

2: Install one 5/16" x 3-1/2" Lag Screw with 5/16" washer into the empty holes in all of the 2 x 6 parts at the base of the play set frame.

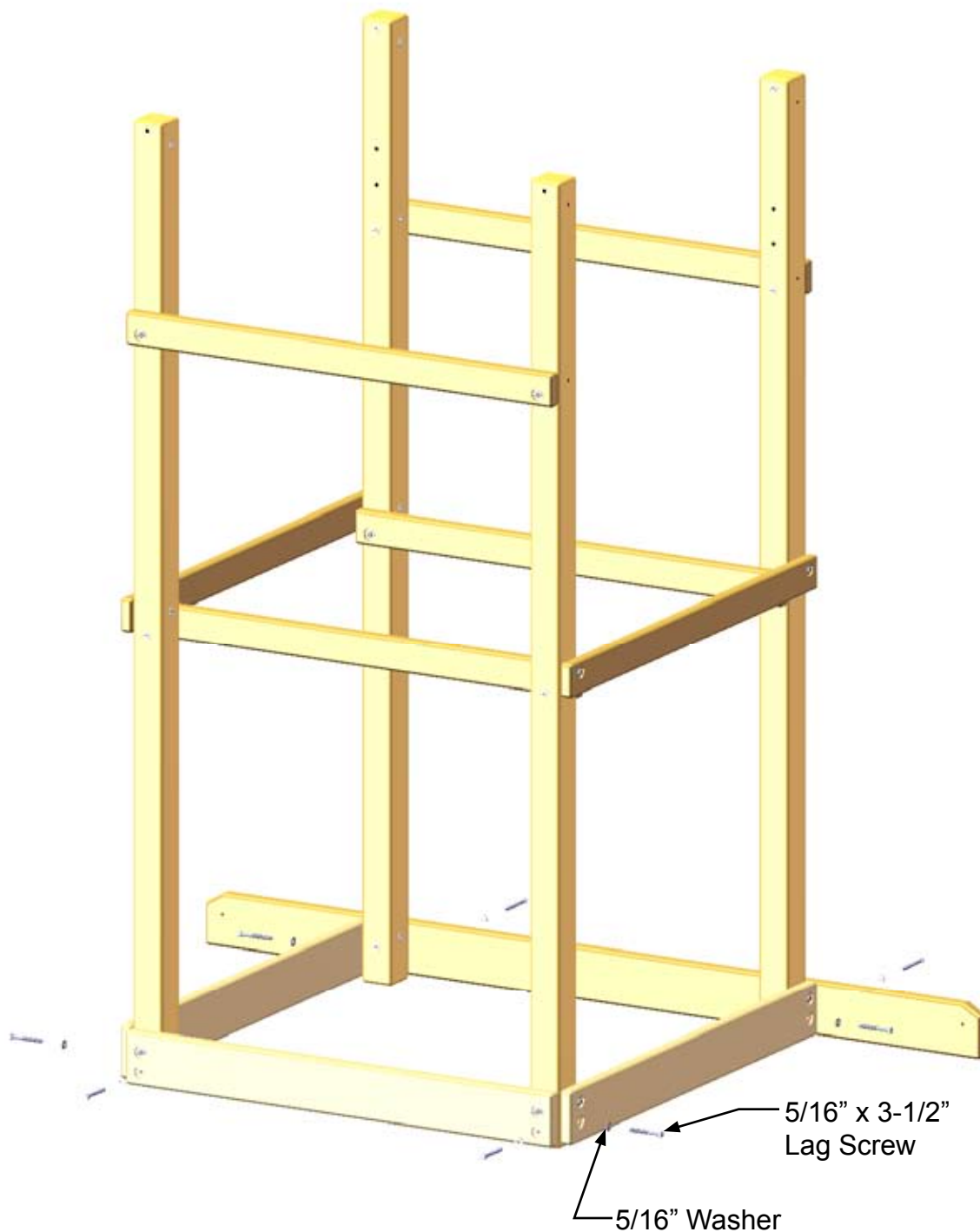

Step 8: Fort Supports

- 1: Place a 5/16" Tee Nut into the hole in the Fort Supports as shown.
- 2: From the Rear side of the Rear Panel Board loosely attach each Fort Support with one 5/16" x 2-1/2" Hex Bolt and one 5/16" washer.
- 3: Measure 2" and 3-1/2" down from the tip of each Fort Support and drill a 1/8" hole through the Fort Support along the center. (See Detail A)
- 4: Place each Fort Support against the Rear Corner Post. The side of the Fort Support should be flush with the rear side of the Rear Corner post.
- 5: Attach the angled end of each Fort Support with one 2-1/2" Wood Screw and one 3" Wood Screw. Tighten each 5/16" x 2-1/2" Hex Bolt.

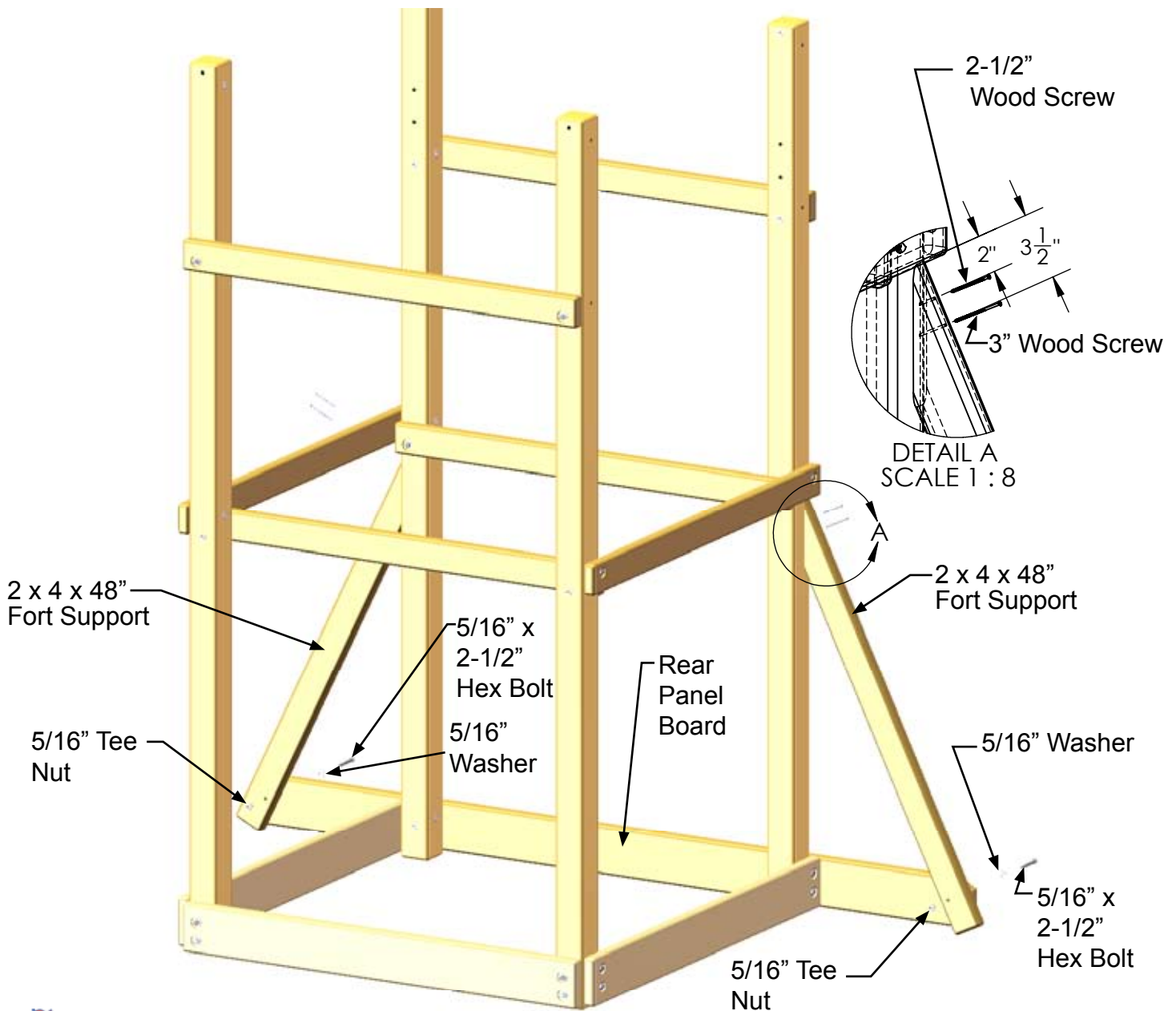

Step 9: Deck Spacers

1: Place a 5/4 x 4 x 40-1/2" Deck Spacer between the Front and Rear Corner Posts on top of the Deck Supports as shown below.

2: The Deck Spacer side should be flush with the inside of the Panel Support.

3: Attach each Deck Spacer to the Deck Supports with two 2" Wood Screws.

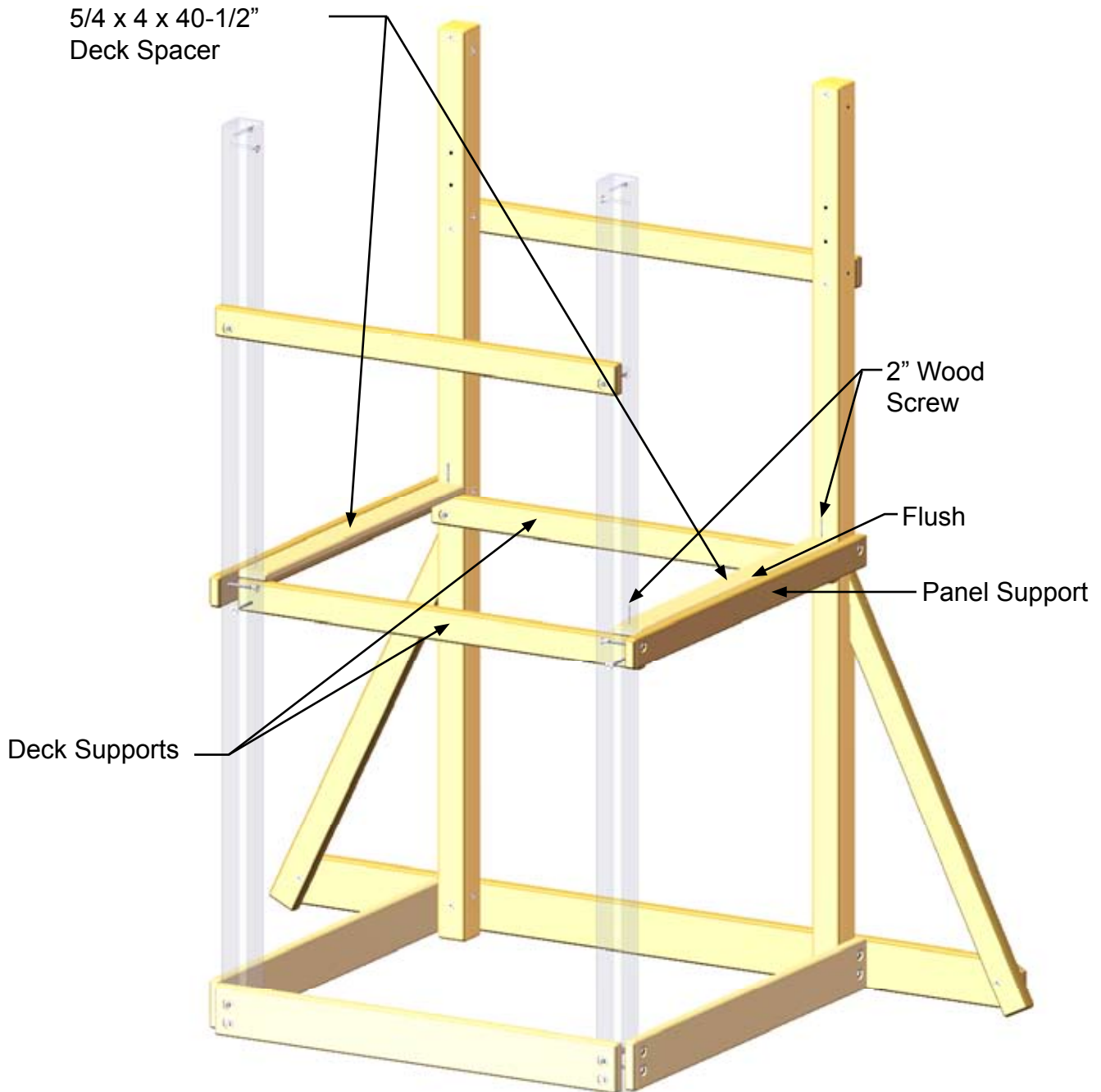

Step 10: Deck Stringer

- 1: Center the 2 x 4 x 47-3/8" Deck Stringer underneath the Deck Spacers.
- 2: Attach the Deck Stringer to the Deck Spacers with two 2" Wood Screws.

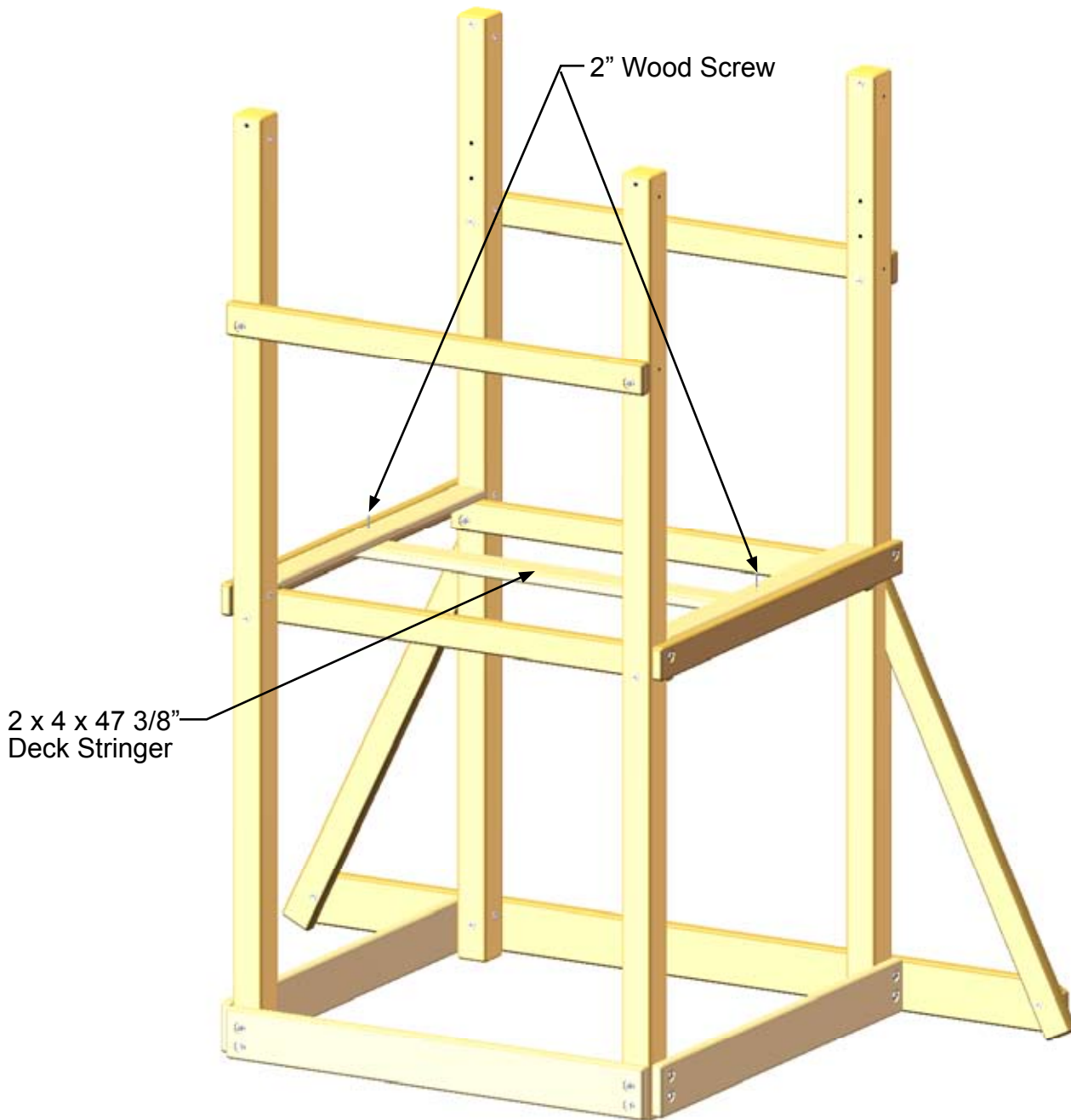

Step II: Face Boards

- 1: Locate two 2 x 4 x 47-3/8" Face Boards.
- 2: Attach a Face Board to the front of the Front Corner posts making sure the top side is flush with the top side of the Panel Supports.
- 3: Attach the Face Board with six 2-1/2" wood screws.
- 4: Repeat this process attaching the other Face Board to the rear side of the Rear Corner posts.

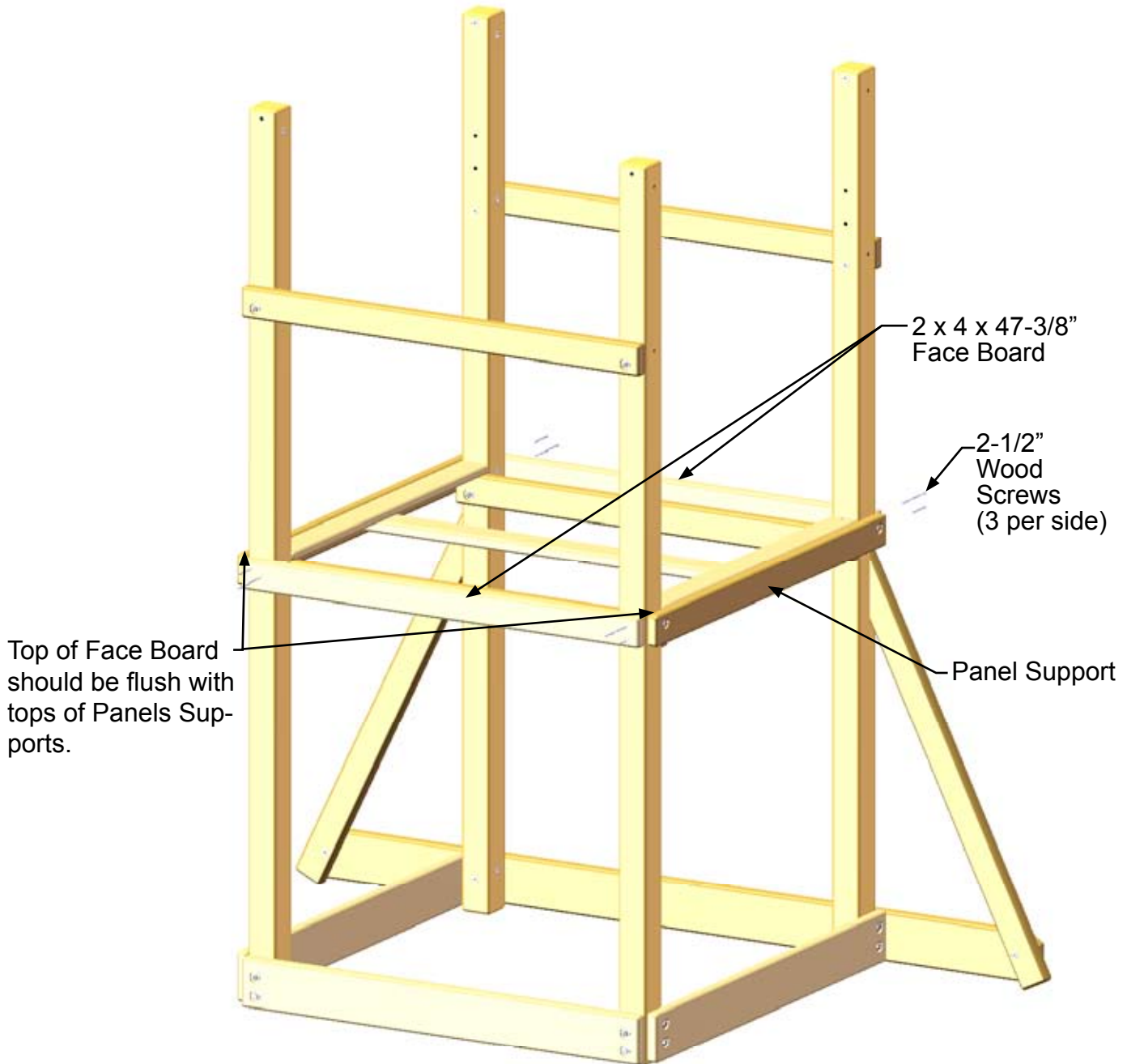

Step 12: Ladder Assembly

1: Lay one 2 x 4 x 57" Ladder Side on a flat surface with channels facing down. Place the barrel of a T-Nut in the hole at the top of the Ladder Side, and secure with a hammer. Repeat this step for the other Ladder Side.

1: Flip the Ladder Side over so that the channels are facing up.

2: Place the Ladder Steps into the channels, and then place the second Ladder Side on top, with the channels facing down.

3: Now place two 2" wood screws in each step.

4: Carefully turn the ladder over and finish the other side with two 2" wood screws per step.

5: Install two 90° green brackets using 1 1/2" bolts and 5/16" washers

6: Install the 5/4 x 4 x 18 1/2" ladder back above the opening of the top channels with two 2" wood screw per side.

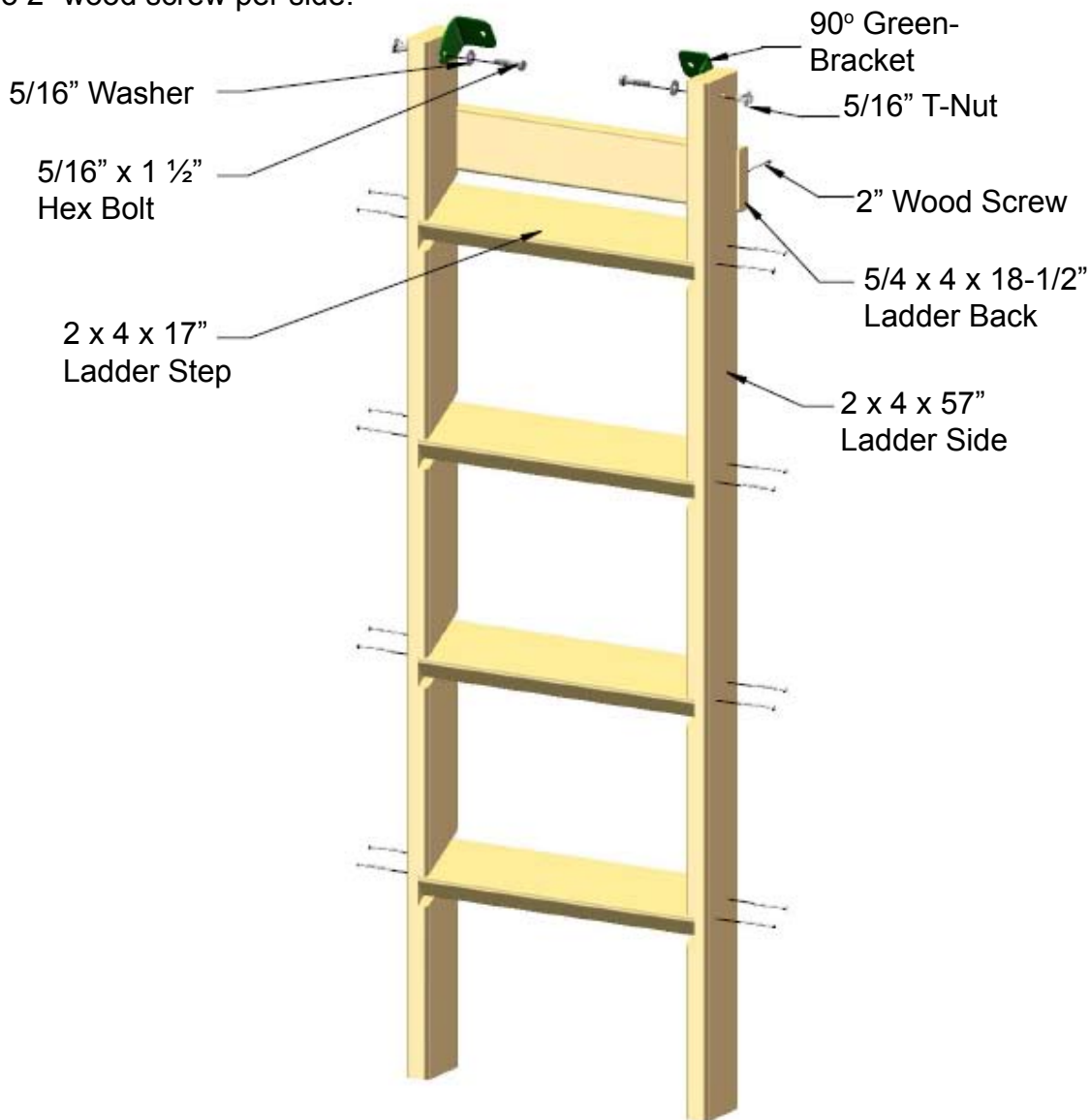

Step 13: Attaching The Ladder

- 1: The Ladder attaches to the left side of the play set, 14-7/16" from the outside edge of the front corner post.
- 2: Make sure the ladder is level. The bottom edge of the 90° brackets should be 3/4" up from the bottom edge of the 2 x 4. Mark the position of the bracket holes on the 2 x 4.
- 3: Drill 3/8" holes where marked.
- 4: Insert 5/16" T-nuts in the back of the holes.
- 5: Attach the 90° brackets to the 2 x 4 with two 1-1/2" hex bolts and two 5/16" washers.

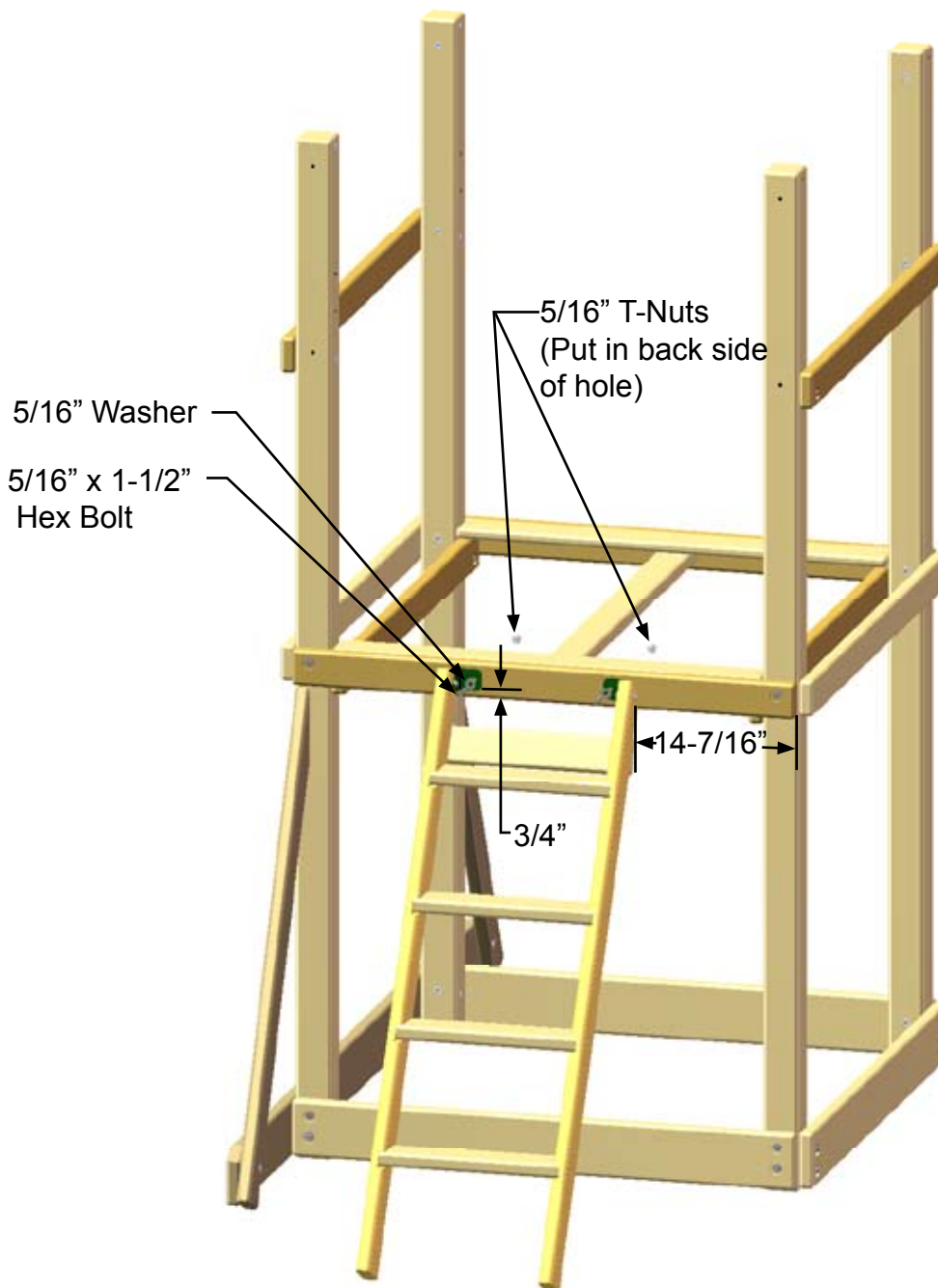

Step 14: Deck Boards

- 1: Seven 5/4 x 6 x 47 3/8" Deck Boards will lay across the Deck Supports, flush to the Face Boards. There will be approximately a 1/4" gap between each Deck Board.
- 2: Space the Deck Boards evenly across the supports.
- 3: Secure each Deck Board to the Deck Supports and the Deck Stringer with five 2" wood screws, two per end and one in the center.

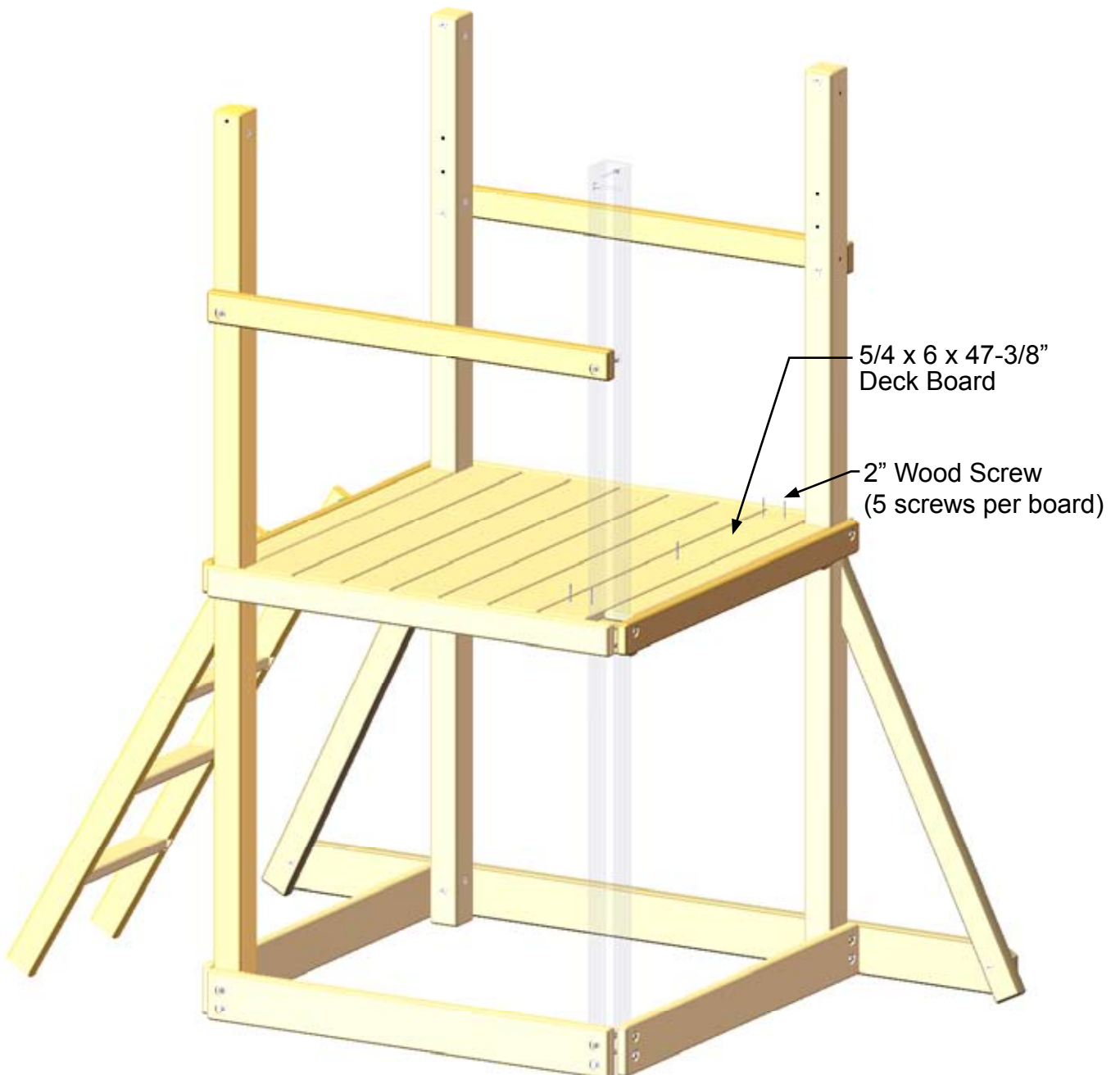

Step 15: Panel and Panel Support Boards

1: Place the 2 x 4 x 12" Bottom Panel Board - Left and 2 x 4 x 12" Bottom Panel Board - Right on top of the 2 x 4's as shown below with offset holes up. Attach each Bottom Panel Board with one 5/16" x 3-1/2" lag screw and 5/16" washer.

2: Place the 2 x 4 x 47-3/8" Panel Support against the left side of the play set with offset holes up. Attach the Panel Support with two 5/16" x 4-1/2" hex bolts and 5/16" washers.

3: Place the 2 x 4 x 47-3/8" Rock Wall Side Top Panel Board against the right side of the play set with offset holes up. Attach the Rock Wall Side Top Panel Board with two 5/16" x 4-1/2" hex bolts and 5/16" washers.

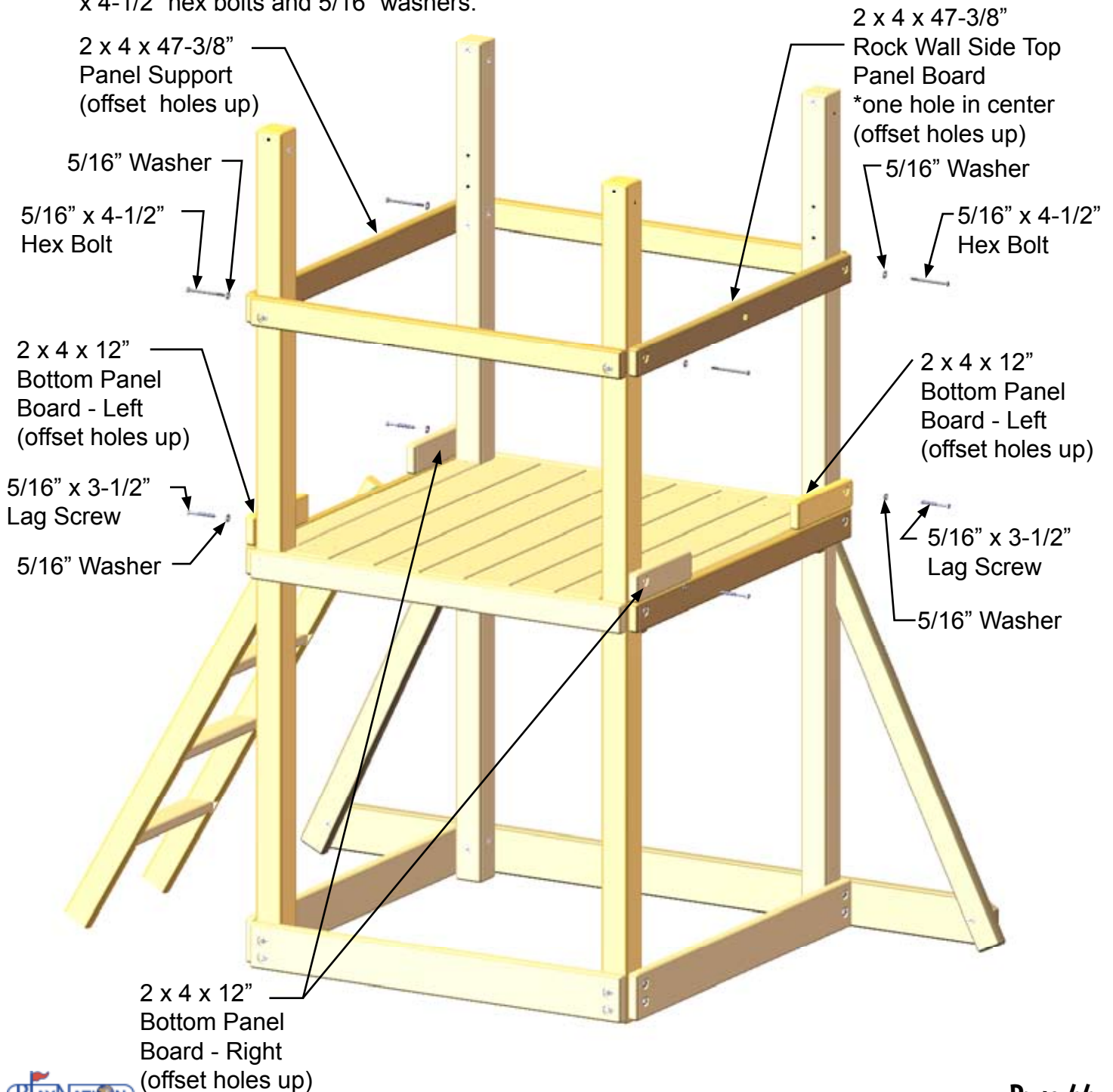

Step 16: Panel Boards

1: Place the 2 x 4 x 12" Bottom Panel Board - Left and 2 x 4 x 12" Bottom Panel Board - Right on top of the 2 x 4 at the front of the play set as shown below with offset holes down. Attach each Bottom Panel Board with one 5/16" x 3-1/2" lag screw and one 5/16" washer.

2: Place the 2 x 4 x 47-3/8" Panel Support on top of the 2 x 4 at the rear of the play set with offset holes down. Attach the Panel Support with two 5/16" x 3-1/2" lag screws and two 5/16" washers.

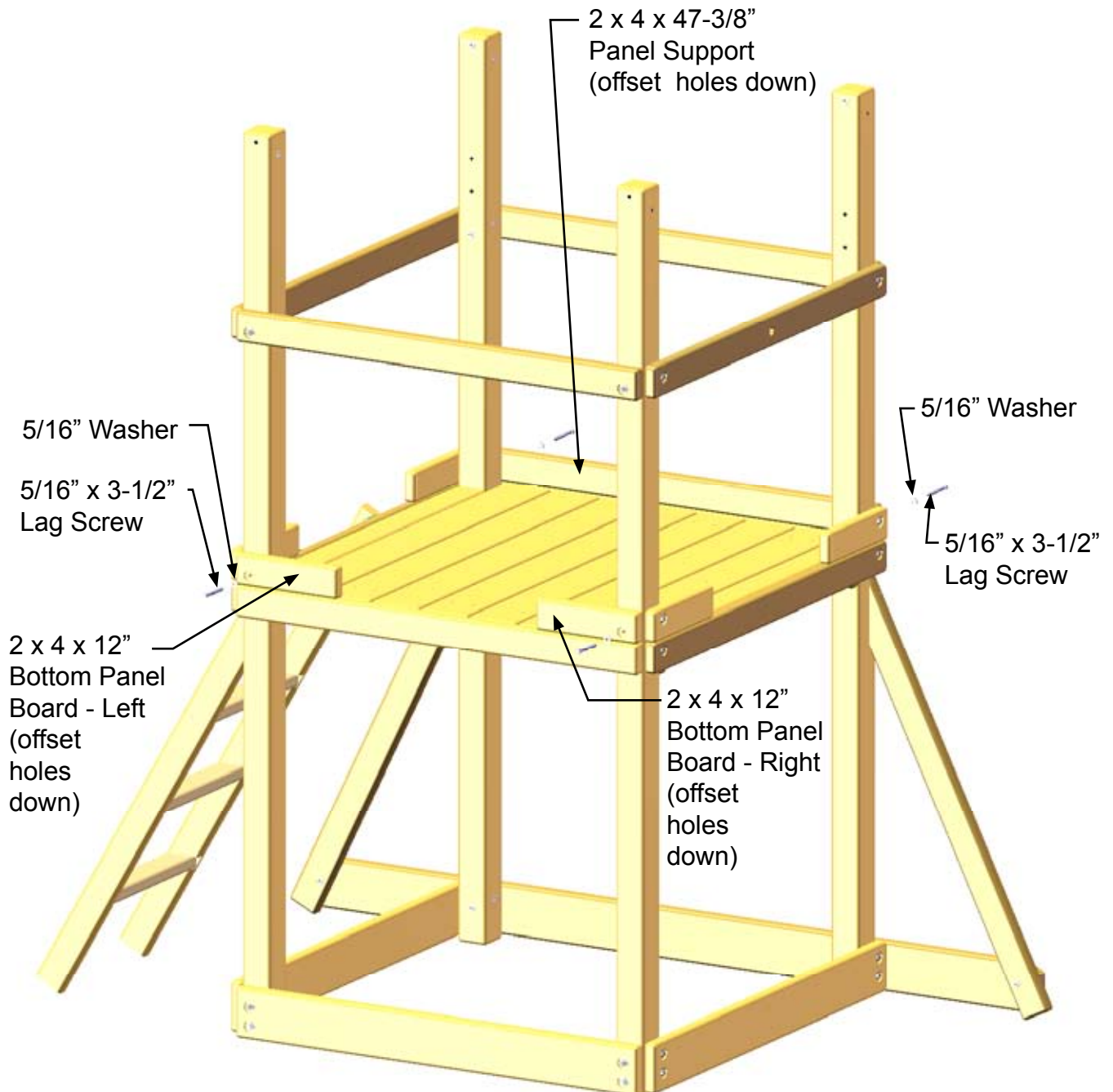

Step 17: Panel Slats

1: Locate nineteen 5/4 x 3 x 28" Panel Slats. Four Panel Slats will be installed at both the left, right and front of the play set. Seven Panel Slats will be installed at the rear of the play set..

2: At the rear of the play set center one Panel Slat over the center of each deck board. Square each Panel Slat to the Panel Support. Attach each Panel Slat to the inside of the Panel Supports with two 2" wood screws for each Panel Slat.

3: At each side and at the front of the play set place one Panel Slat flush with the end of the 2 x 4 x 12" Bottom Panel Board. Square the top of the Panel Slat with the Panel Support or Panel Board. Attach the Panel Slat to the Panel Board/Panel Support with two 2" wood screws. Center another Panel Slat between the one you just installed and the corner post. Attach the Panel Slat with two 2" wood screws.

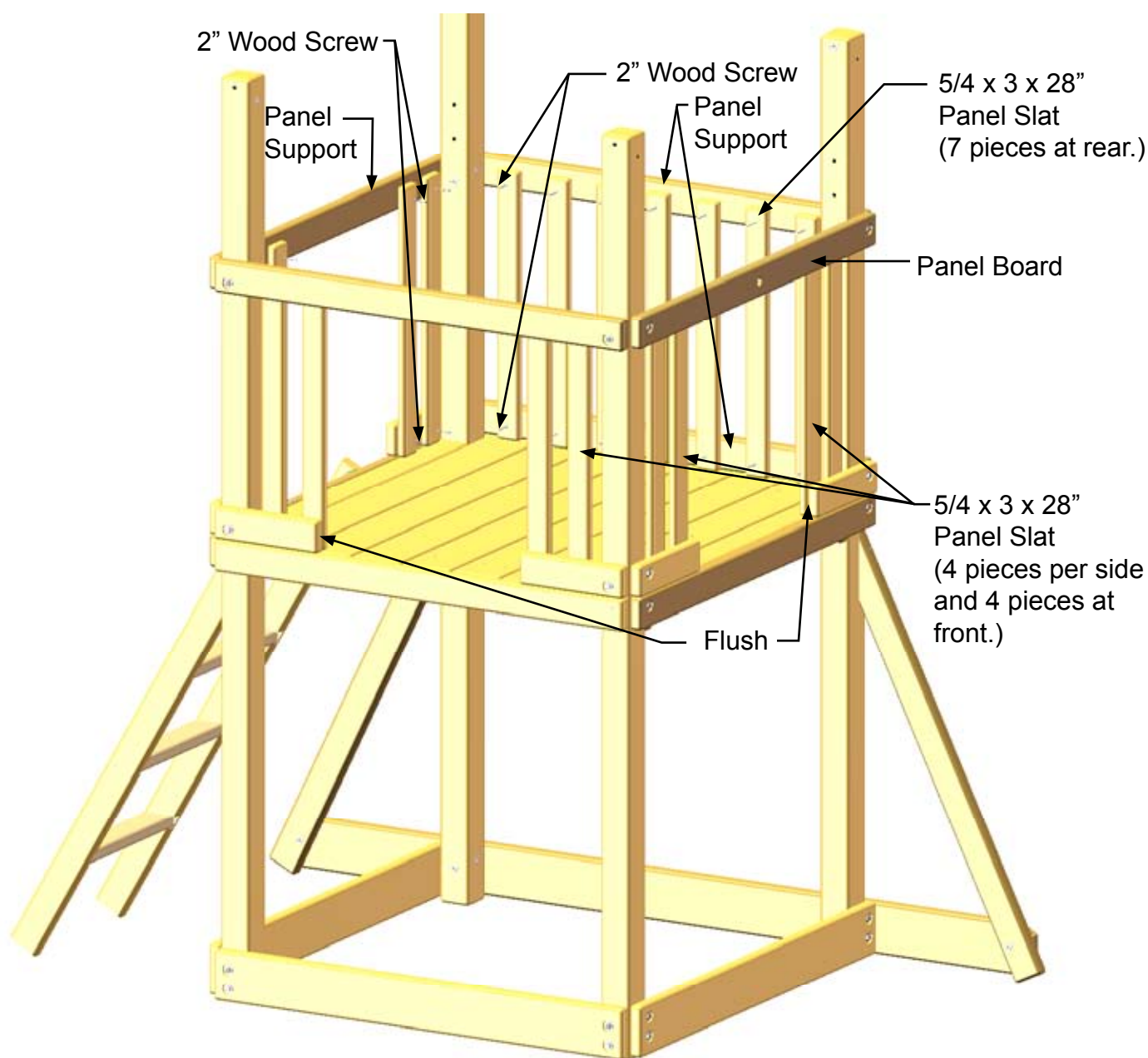

Step 18: Rock Wall

1: Locate two 2 x 4 x 57 Rock Wall Side boards. Lay the boards out as shown and insert a 5/16" t-nut into the hole on the inside of each board. Use a hammer to set each t-nut flush with the board.

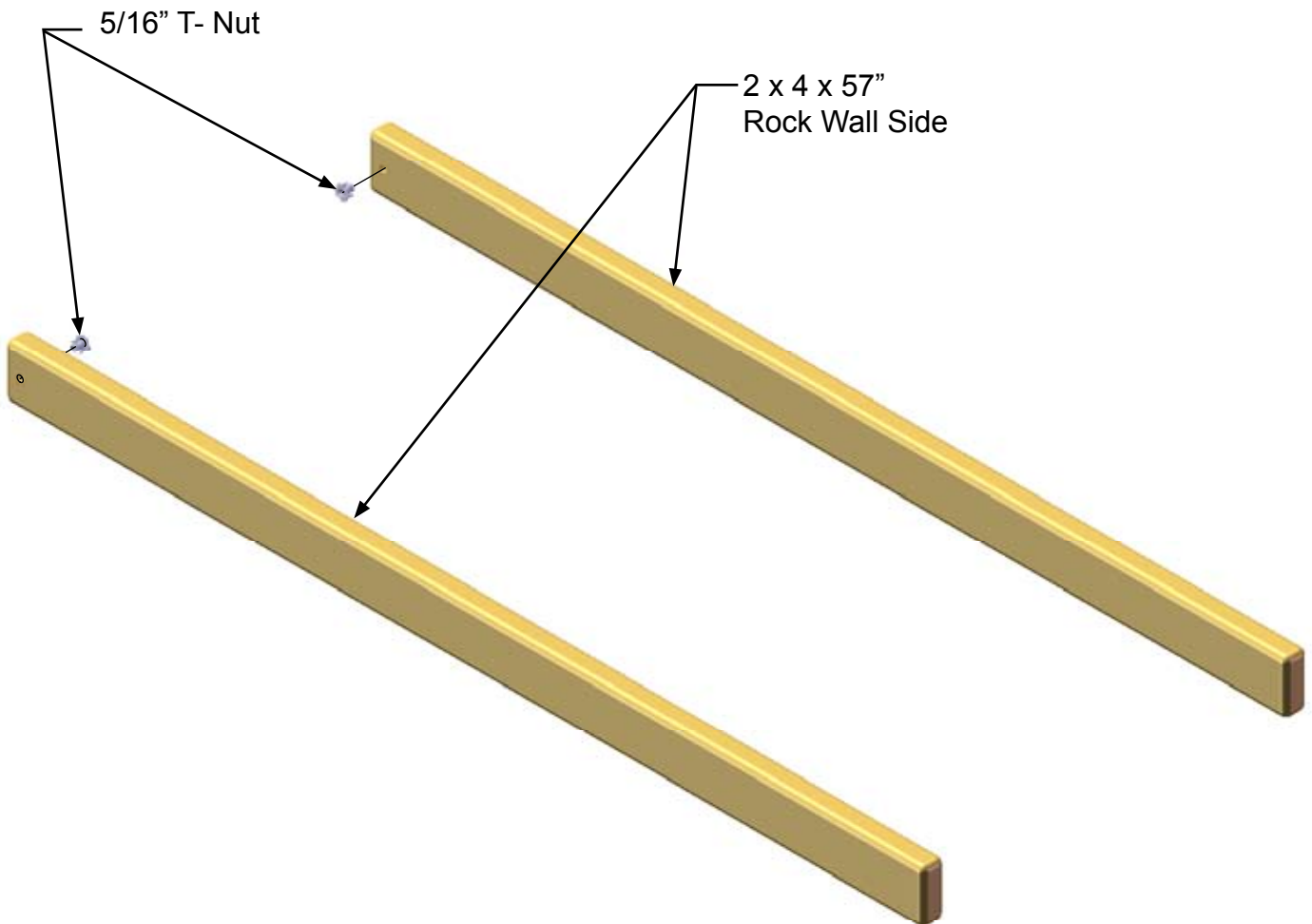

Step 19: Rock Wall

1. Locate ten $5/4 \times 5 \times 23\text{-}7/8$ " Rock Wall Boards and one $5/4 \times 5 \times 23\text{-}7/8$ " Bottom Rock Wall Board with one big hole in it.
2. Place one Rock Wall Board at the top of the Rock Wall Sides nearest the holes where you previously installed the tee nuts. Make sure the Rock Wall Board is flush with the ends and sides of the Rock Wall Side boards.
3. Attach the Rock Wall Board with four 2" wood screws.
4. Now place another Rock Wall Board beneath the one previously installed and attach with four 2" wood screws. Continue installing Rock Wall Boards to the Rock Wall Sides until they are used up.
5. Attach the Bottom Rock Wall Board with one large hole in it last with four 2" wood screws. The large hole should be offset up.

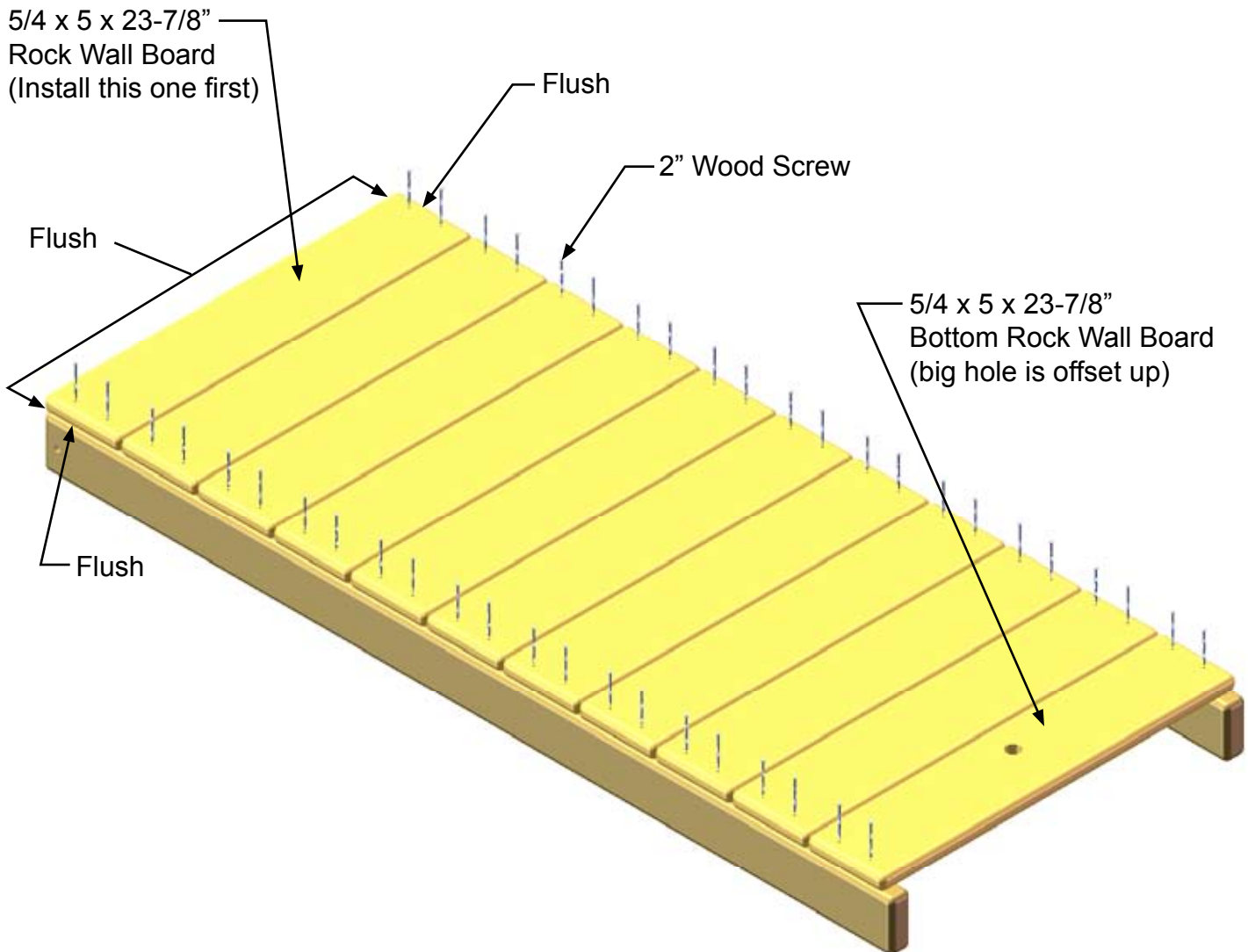

Step 20: Rock Wall

1. Locate two 90° Green Brackets, two 5/16" washers and two 5/16" x 1-1/2" hex bolts.
- 2: Fasten the tapered side of each 90° Green Bracket to each Rock Wall Side with a 5/16" x 1-1/2" hex bolt and 5/16" washer.

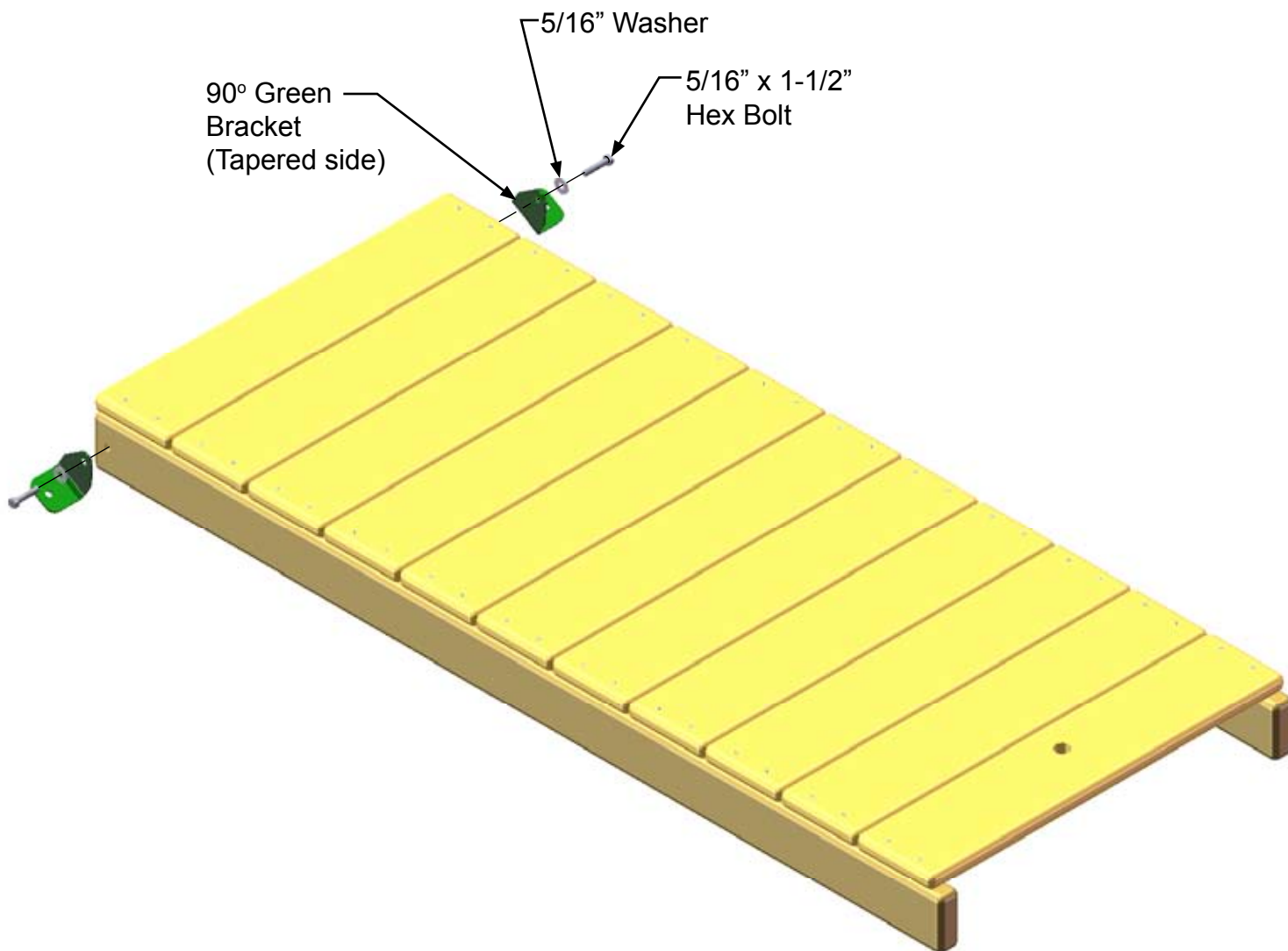

Step 21: Rock Wall

- 1: Locate two bags of Climbing Rocks. Inside each bag should be five rocks, fifteen #14 x 1-1/4" pan head screws and fifteen 1/4" flat washers
- 2: Place the Climbing Rocks in a staggered pattern on the Rock Wall Boards. Place one rock on each board except for the bottom rock wall board with the hole in it.
- 3: Attach each Climbing Rock with three #14 x 1-1/4" pan head screws and three 1/4" flat washers.

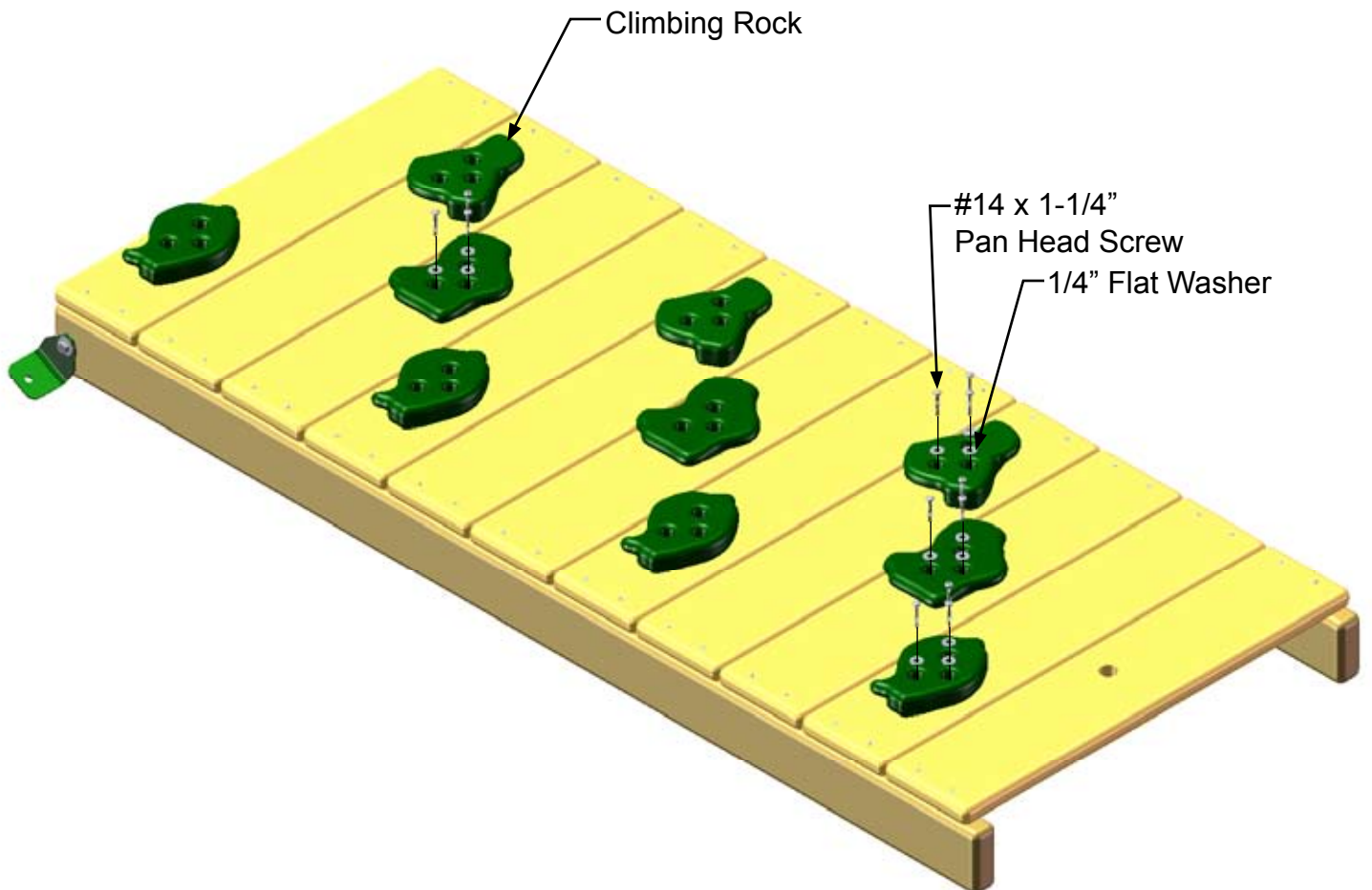

Step 22: Rock Wall

1: Place the 5/4 x 3 x 23-7/8" Rock Wall Top Cap on top of the Rock Wall Sides flush with the top Rock Wall Board.

2: Fasten the 5/4 x 3 x 23-7/8" Rock Wall Top Cap to the Rock Wall Sides and the top Rock Wall Board with four 2" wood screws. .

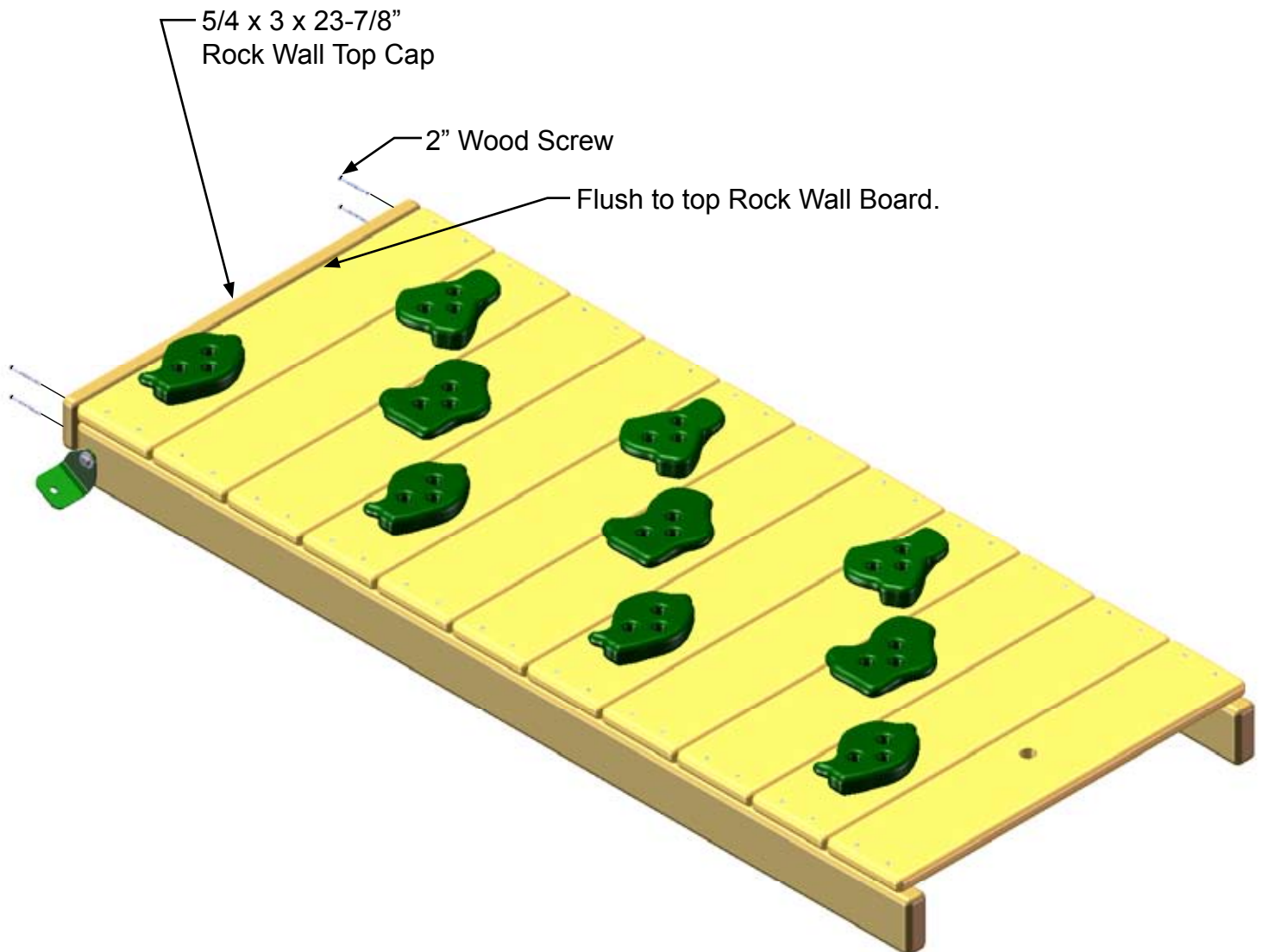

Step 23: Attaching Rock Wall

- 1: The Rock Wall attaches to the right side of the play set, 11-3/4" from the outside edge of the rear corner post.
- 2: Make sure the Rock Wall is level. The bottom edge of the 90° brackets should be 3/4" up from the bottom edge of the 2 x 4. Mark the position of the bracket holes on the 2 x 4. Drill 3/8" holes where marked.
- 3: Insert 5/16" t-nuts in the back of the holes.
- 4: Attach the 90° brackets to the 2 x 4 with two 1-1/2" hex bolts and two 5/16" washers.

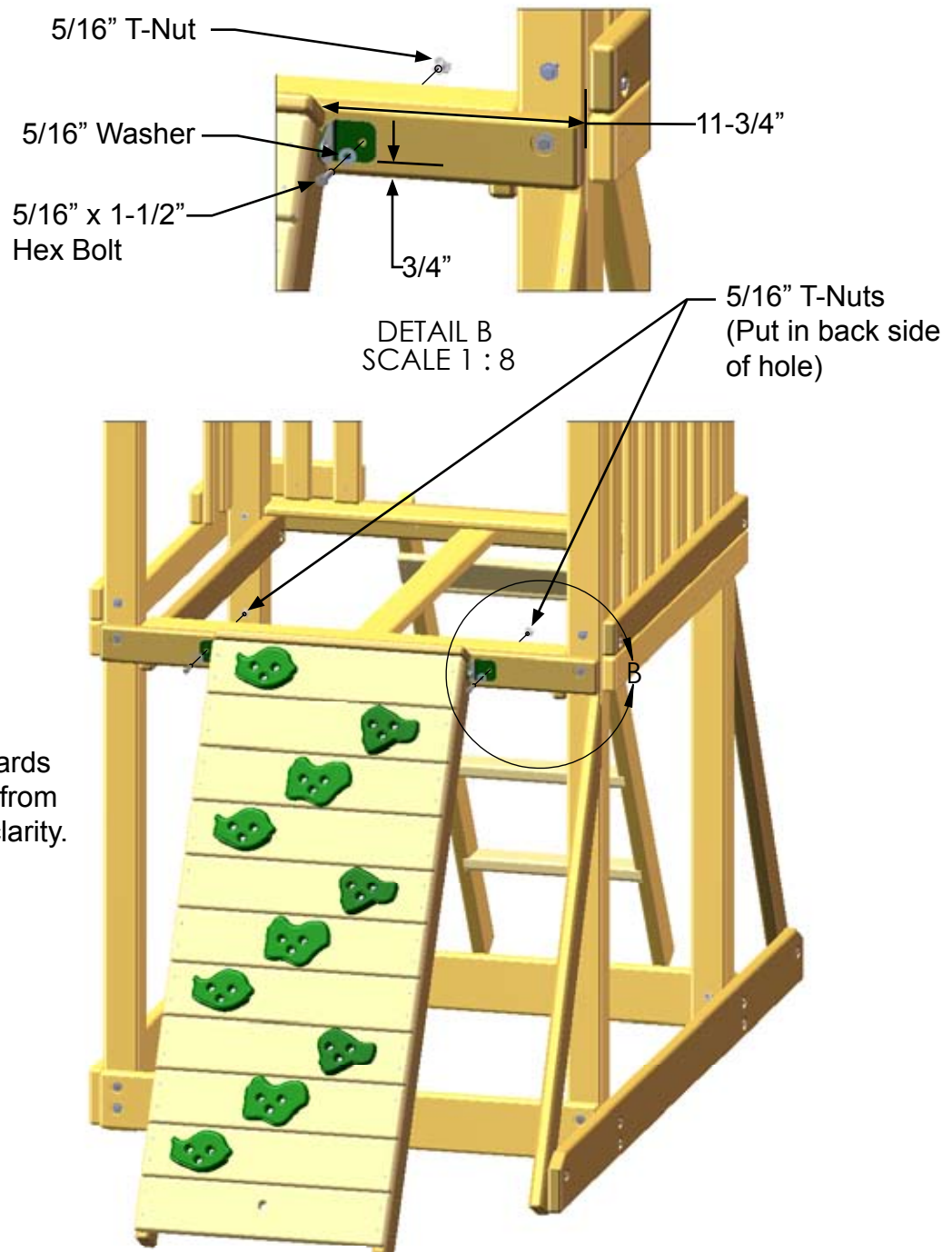

Note:
Some boards
removed from
view for clarity.

Step 24: Swing Beam Support

1. The 4 x 4 x 47-3/8" Swing Beam Support has counter-sunk holes in the center and on the ends. Install the Swing Beam Support so that the counter-sunk holes on each end of the beam face out, and the counter-sunk holes in the center face down.

2. Fasten the Swing Beam Support to the rear corner posts using 3/8" x 6-1/2" carriage bolts and torque washers. Place the carriage bolt into the torque washer, then into the hole of the corner post and set with a hammer. Use 3/8" lock nuts and 3/8" washers to secure the Swing Beam Support from the outside. Place bolt caps over the exposed threads after securing.

Note: There are two mounting positions for the Swing Beam Support. Use the lower holes in the rear corner posts if your yard is relatively flat. Stand with your back against the rear of the play set. If your yard runs uphill then you should use the upper holes in the rear corner posts.

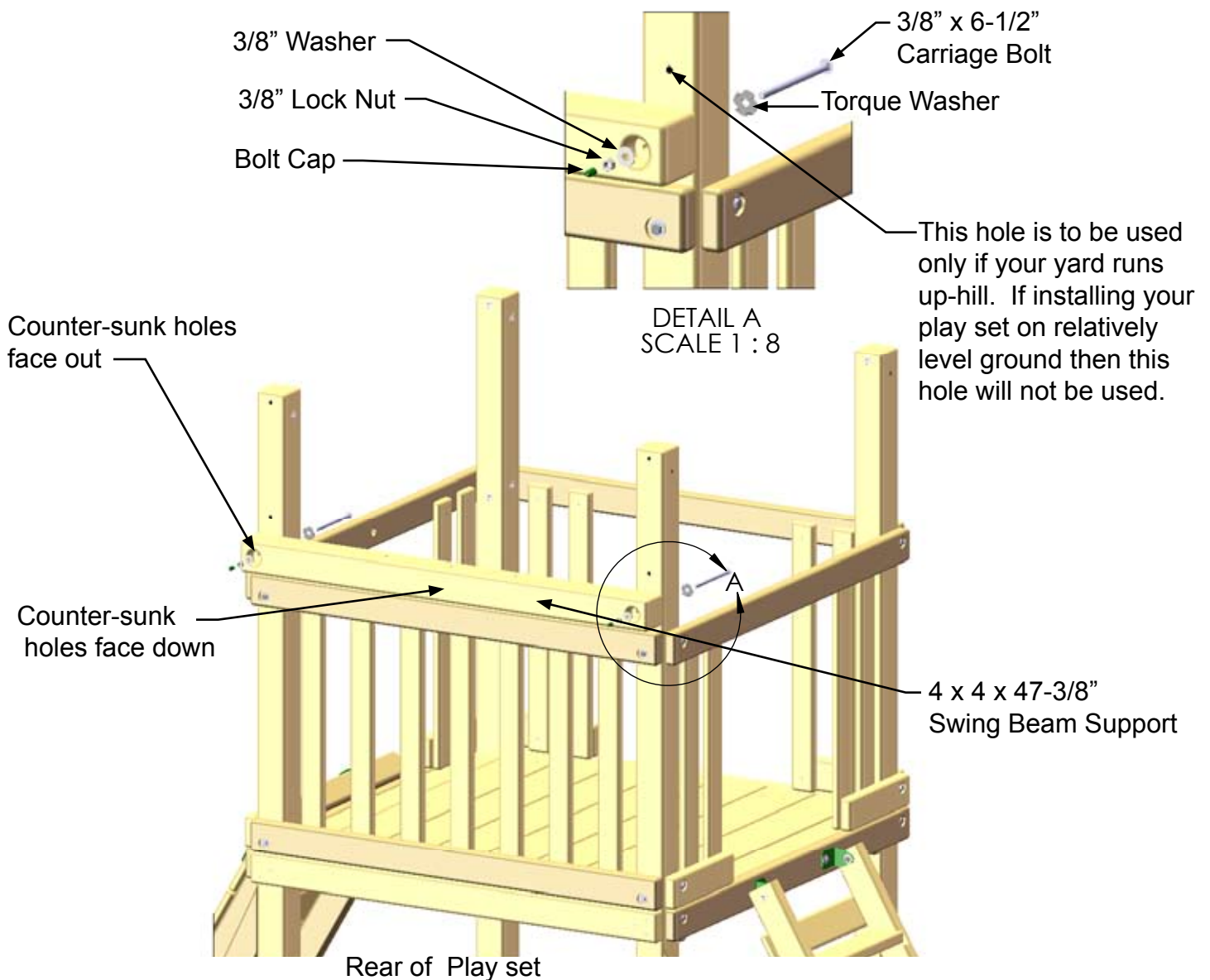

Step 25: Swing Beam Plate

- 1: Place the Swing Beam Plate on top of the Swing Beam Support, lining up the pilot holes.
- 2: Fasten the Swing Beam Plate to the Swing Beam Support on the outside holes using $3/8"$ x $3-1/2"$ carriage bolts from the top and $3/8"$ washers with $3/8"$ lock nuts on the bottom. Place bolt caps over exposed threads after securing.
- 3: Leave the middle hole empty, it will be used later.

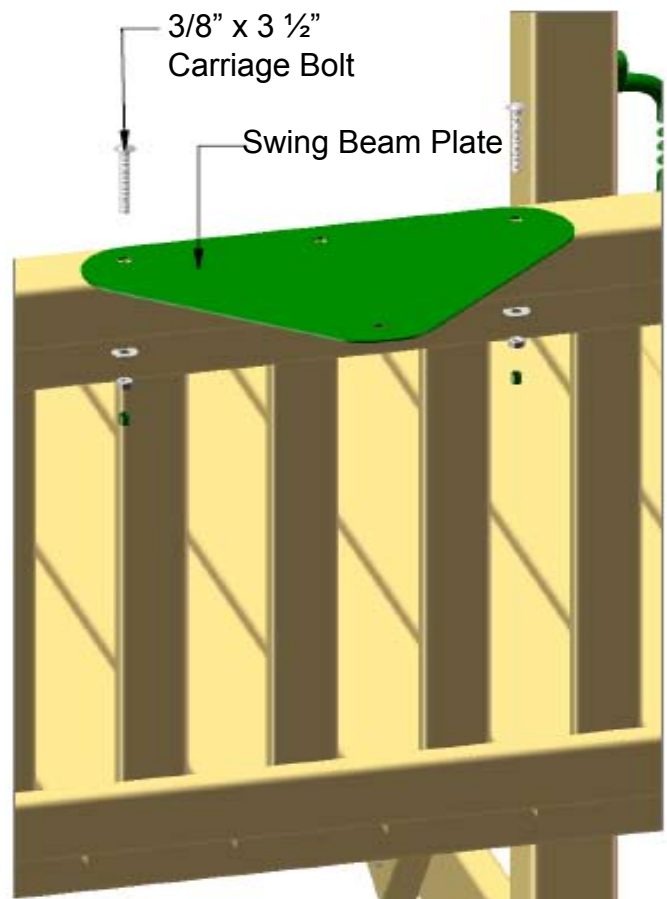
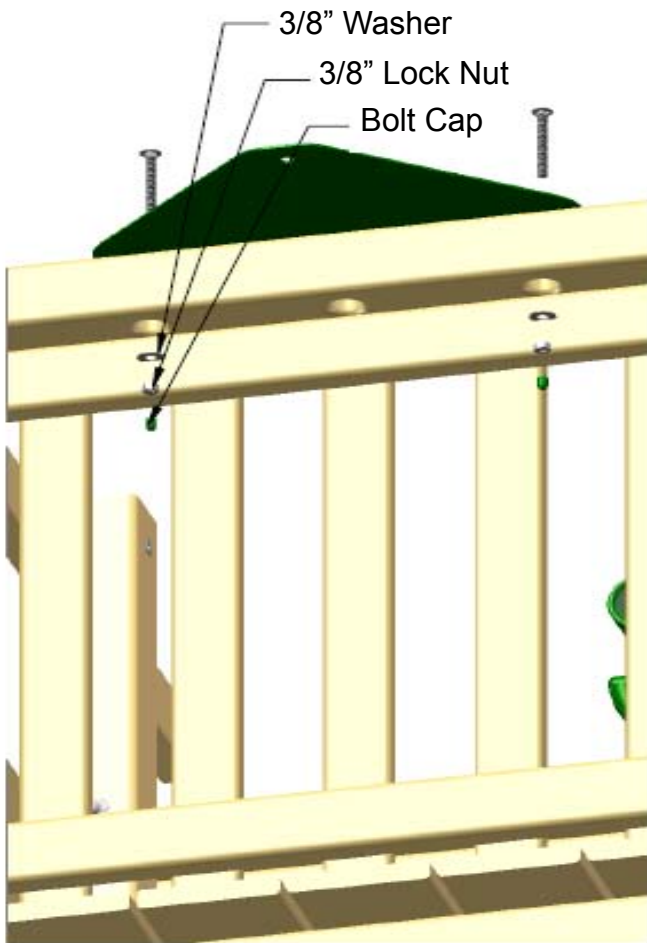

Step 26: Attach Swing Legs To Bracket

- 1: Place the 4 x 4 x 96" Swing Legs flush to the top of the Swing Leg Bracket.
- 2: Fasten the Swing Legs to the Swing Leg Bracket with eight 3/8" x 3-1/2" lag screws and eight 3/8" washers

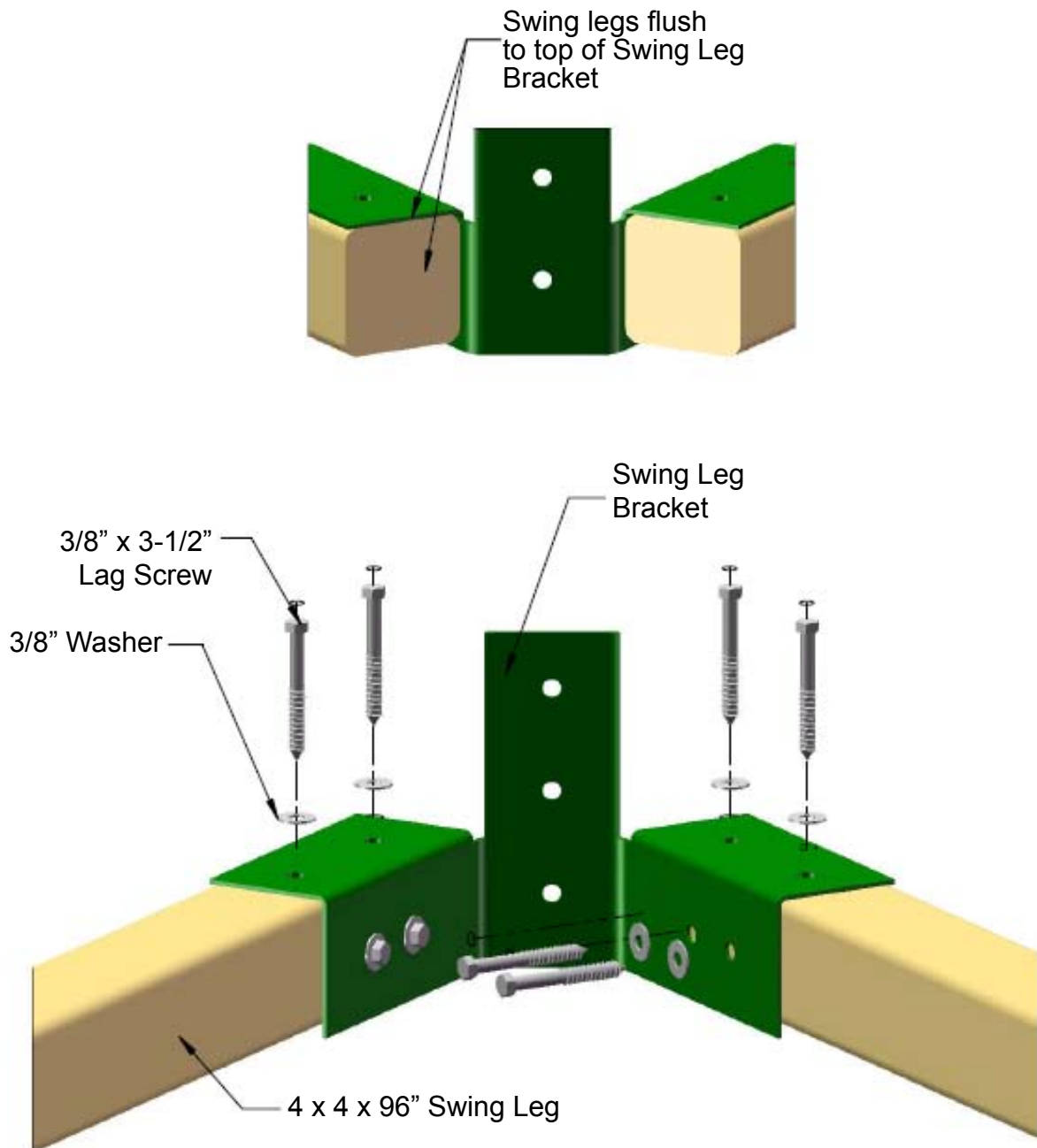

Step 27: Iron Ductiles

1: Line up the holes of the Iron Ductiles with the holes in the Swing Beam.

2: Fasten the Iron Ductiles to the Swing Beam using 3/8" x 7" carriage bolts with torque washers on top of the Swing Beam, and 3/8" lock nuts with 3/8" washers on the bottom. Place bolt caps over exposed threads after securing.

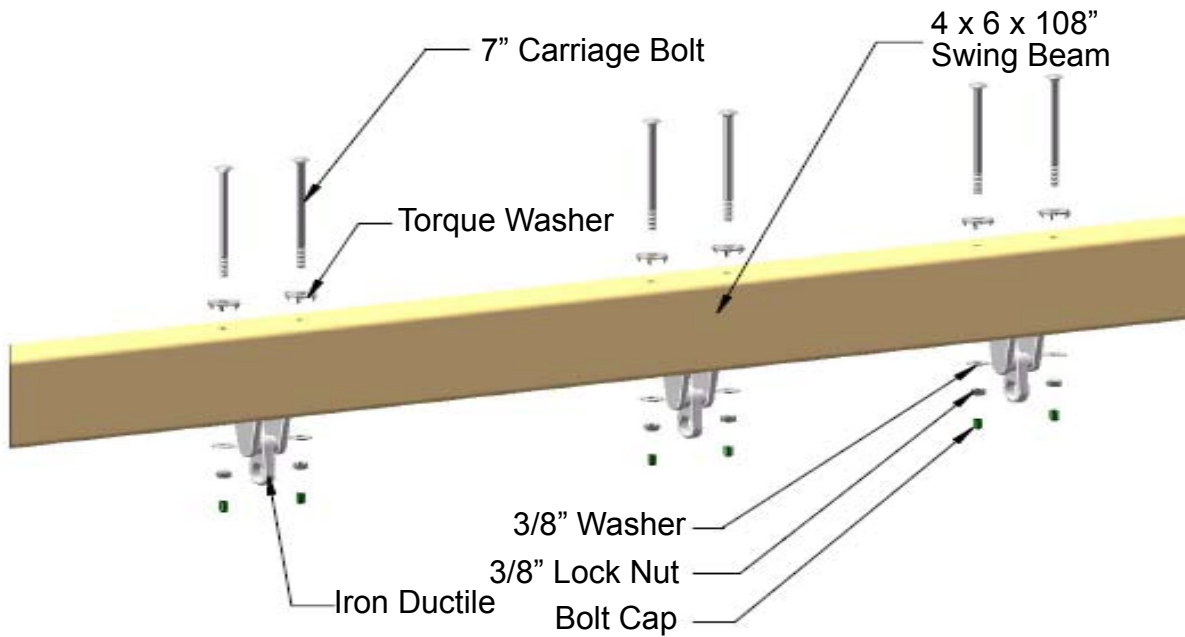

Step 28: Rest Swing Beam on Fort

***Two people are required for this step.**

1. Sit the swing beam legs upright.
2. Line up the pre-drilled holes and rest the swing beam on top of the fort and swing legs. Make sure the iron ductiles are facing down.



Step 29: Swing Beam to Swing Legs

- 1: Fasten the Swing Beam to the Swing Leg Bracket using 3/8" x 6-1/2" carriage bolts with torque washers on top of the Swing Beam, and 3/8" lock nuts with 3/8" washers underneath.
- 2: Use a 3/8 x 3-1/2" lag screw and 3/8" washer in the middle hole of the Swing Leg Bracket.
- 3: Place bolt caps over exposed threads after securing.

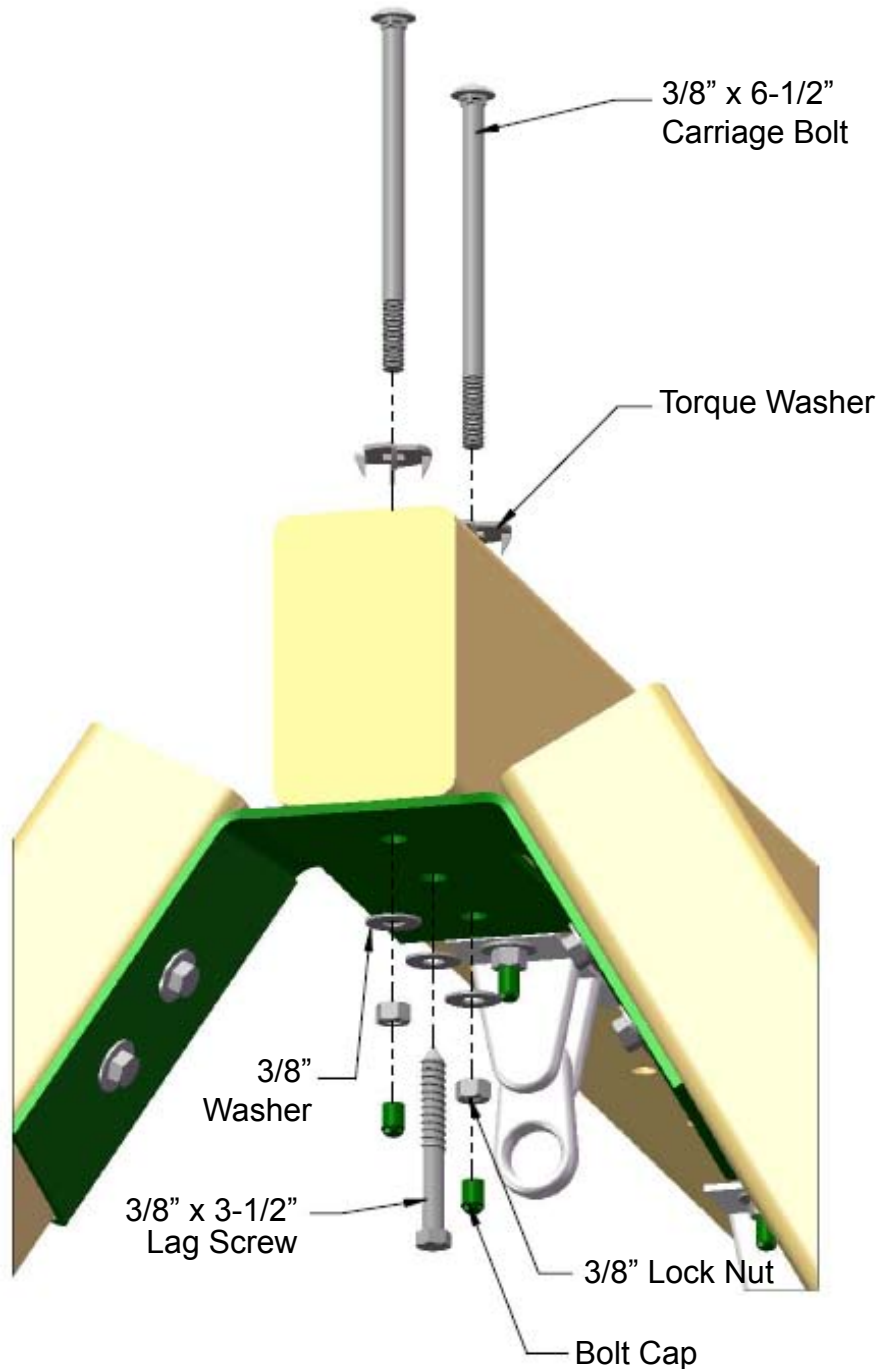

Step 30: Swing Beam to Fort

***Two people are required for this step.**

1: Have one person line up the hole in the end of the Swing Beam with the middle hole on the Swing Beam plate. The other person may have to carry the other end where the legs are located to accomplish this task.

2: Fasten the Swing Beam to the Swing Beam Plate and Swing Beam Support using a 9" carriage bolt with a torque washer on top and a 3/8" lock nut and washer on the bottom. Place green bolt caps over exposed threads after securing.

3: Fasten the Swing Beam to the Swing Beam Plate from underneath with a 3/8" x 3-1/2" lag screw and a 3/8" washer.

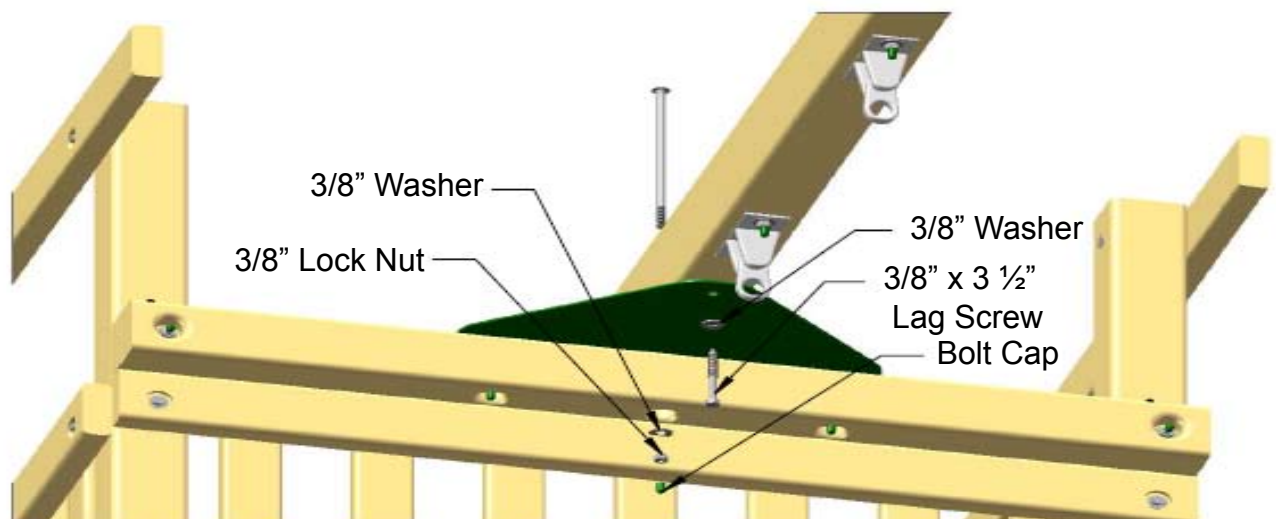
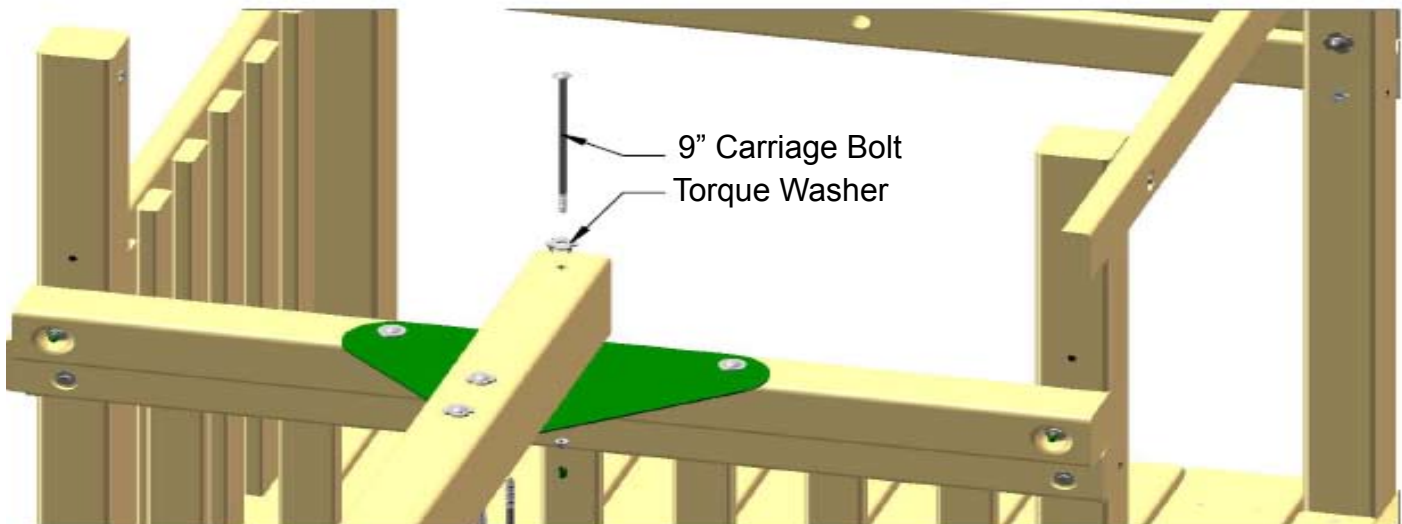

Step 31: Level The Swing Beam

1: Place a level on top of the Swing Beam and adjust the legs in or out as needed to make the Swing Beam level.



Step 32: Swing Leg Cross-Member

- 1: Position the 2 x 4 x 58" Swing Leg Cross-Member against the Swing Legs.
- 2: Level the Swing Leg Cross-Member, and secure to the Swing Legs with 3/8" x 3-1/2" lag screws and 3/8" washers.

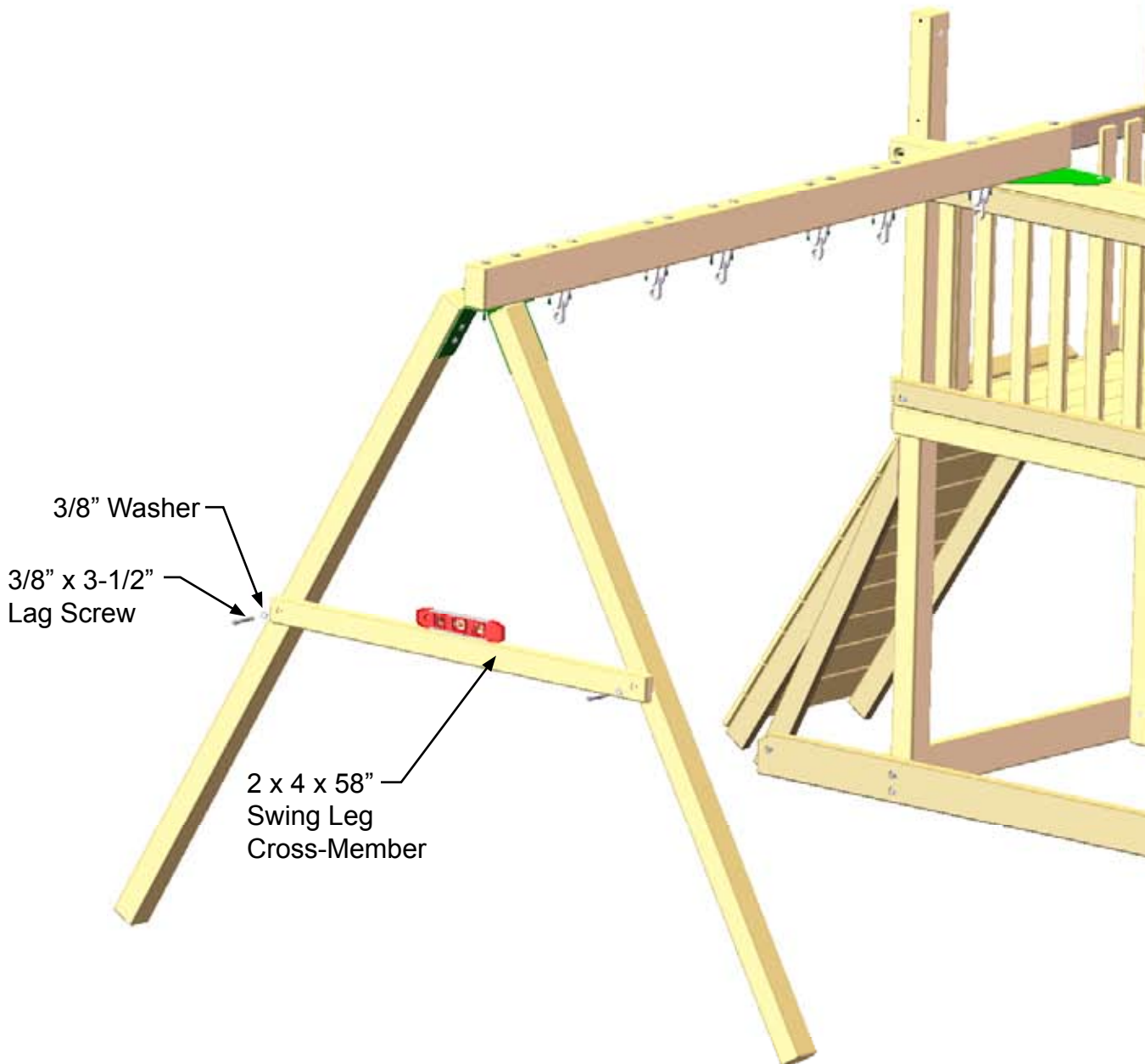

Step 33: Arched Side Top Boards

- 1: Place one Arched Side Top Board on each side of the play set at the top.
- 2: Attach each Arched Side Top Board through the top hole into the t-nut in the corner post with 5/16" x 4-1/2" hex bolts and 5/16" washers.
- 3: Attach each Arched Side Top Board through the bottom hole into the corner posts with 5/16" x 3-1/2" lag screws and 5/16" washers.

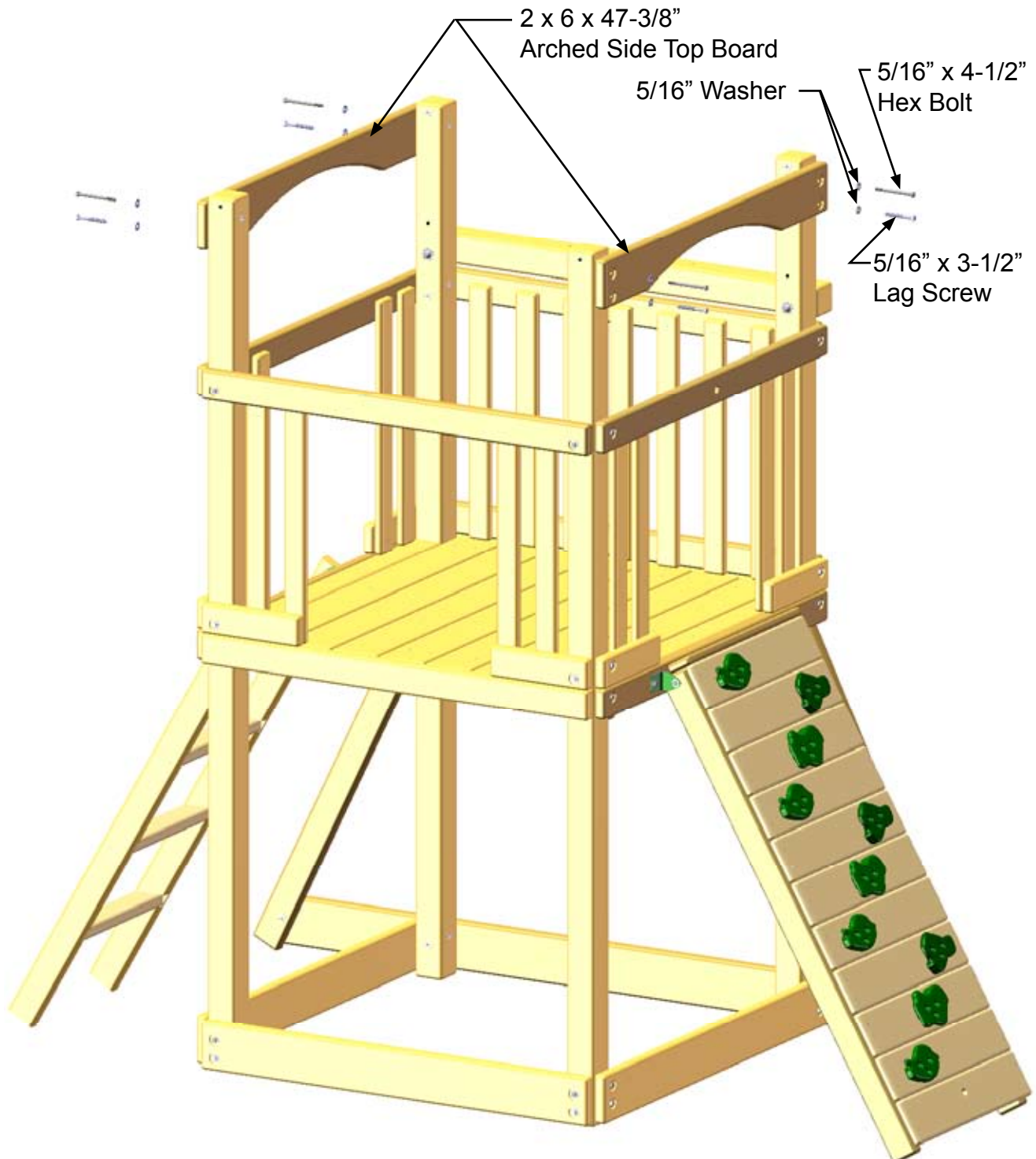

Step 34: Roof Supports

1: Attach one 2 x 4 x 35-1/2" Roof Support-Left and one 2 x 4 x 35-1/2" Roof Support-Right to the front and rear of the play set with 5/16" x 4-1/2" hex bolts and 5/16" washers. Note the counter-sunk holes face out. The roof supports will meet to form a 90° angle at the peak.

2: Place a 5/4 x 6 x 10-1/2" Roof Peak Support at the peak of the roof supports. on the outside. Attach the roof supports to the Roof Peak Support with four 2" wood screws from the inside. The Roof Peak Support should be flush to the roof supports on the top surfaces.

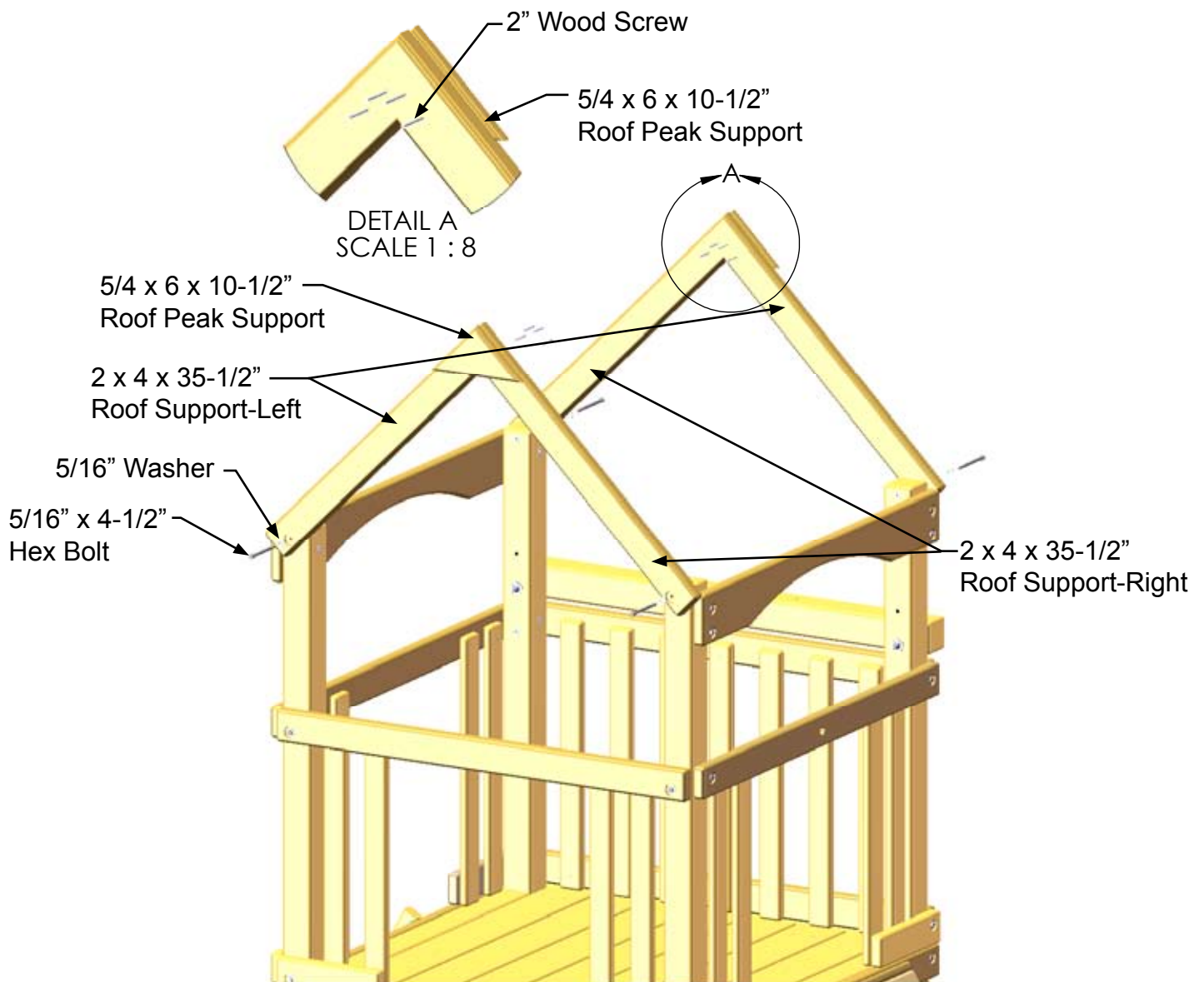

Step 35: Roof Starters/Roof Peak

1: Place the 1 x 5 x 52" (groove only) Roof Starter Boards at the peak of the roof. The holes in the Roof Starters should be centered on the Roof Supports. The flat side of the Roof Starters should be placed as close together as possible near the peak without the boards overlapping.

2: Fasten the Roof Starter Boards to the Roof Supports with 1-1/2" wood screws.

3: Place the 3-1/2 x 3-1/2 x 52" Roof Peak on top of the Roof Starter Boards and fasten with four 1-1/2" wood screws.

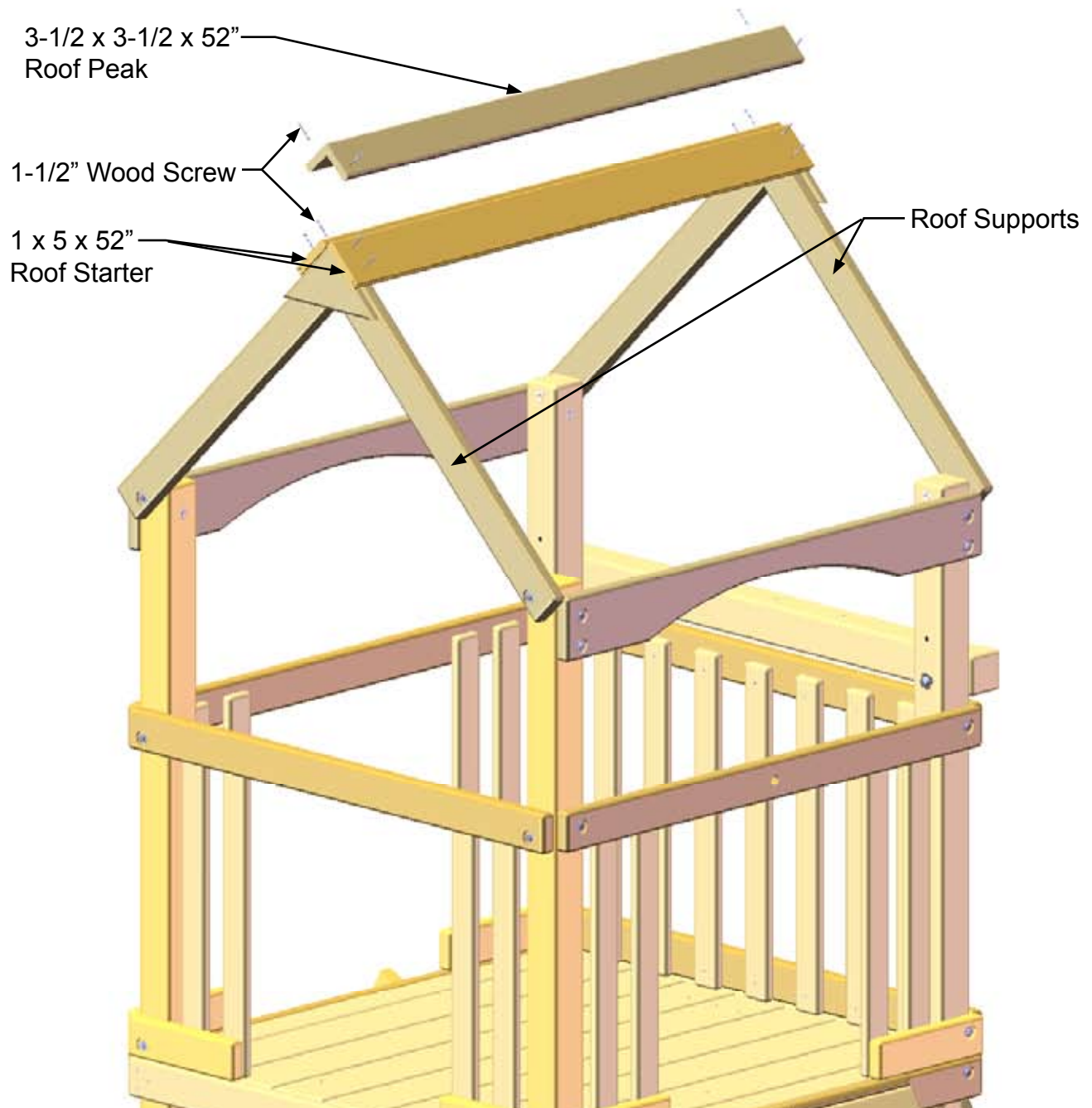

Step 36: Roof Boards/Roof Finishers and Chimney and Dormers

1: Place the 1 x 5 x 52" Roof Boards on top of the Roof Supports, fitting the tongue into the groove of the Roof Starter. The holes in the Roof Boards should be centered over the Roof Supports. There are seven Roof Boards on each side of the roof. If necessary place a scrap 2 x 4 board against the Roof Board and hammer on it to seat the tongue into groove for the Roof Boards. Fasten each Roof Board to the Roof Supports with four 1-1/2" wood screws.

2: Place the 1 x 5 x 52" Roof Finisher at the end of the roof assembly and fasten to the Roof Supports with four 1-1/2" wood screws. Each side of the roof gets one Roof Finisher.

Tip: Use the instructions provided with the Chimney and Dormers to build them. After putting in three Roof Boards on the right roof STOP and then install the Chimney. Notice the mounting block for the Chimney will get installed on the first Roof Board. Once all the Roof Boards/Finishers are installed mount the Dormers as shown below centered on the roof.

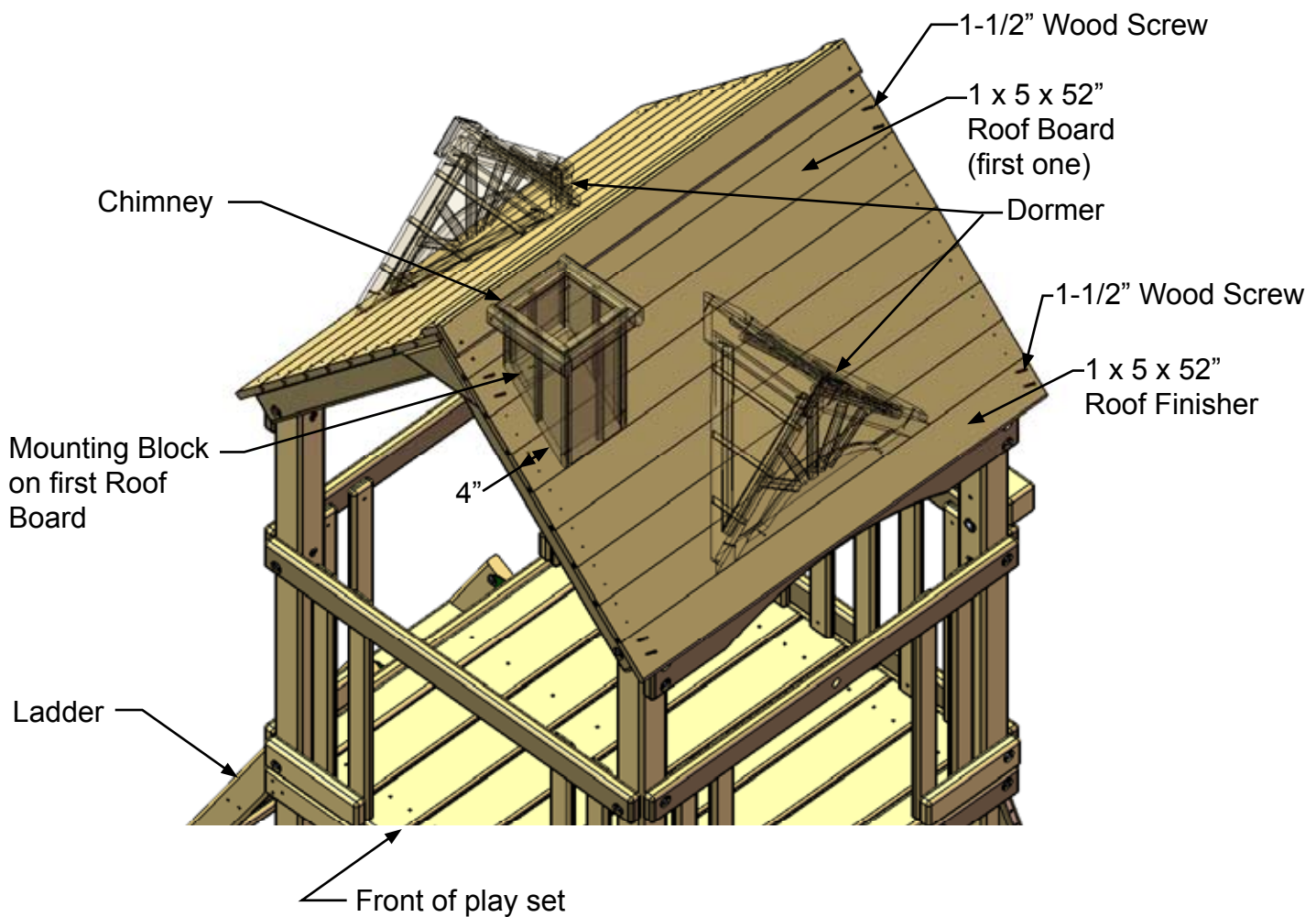

Step 37: Sun Support and Sun

1: Place a 2 x 4 x 43-3/4" Sun Support underneath the Roof Supports. Make sure the Sun Support is level. Attach the Sun Support through the pre-drilled holes in the bottom to the Roof Supports with two 2-1/2" wood screws. Repeat for the other side of the roof.

2: Place a 2 x 6 x 16" Sun centered on top of the Sun Support. The face of the Sun should be flush with the face of the Sun Support. Fasten the Sun to the Sun Support with two 3" wood screws. Repeat for the other side of the roof.

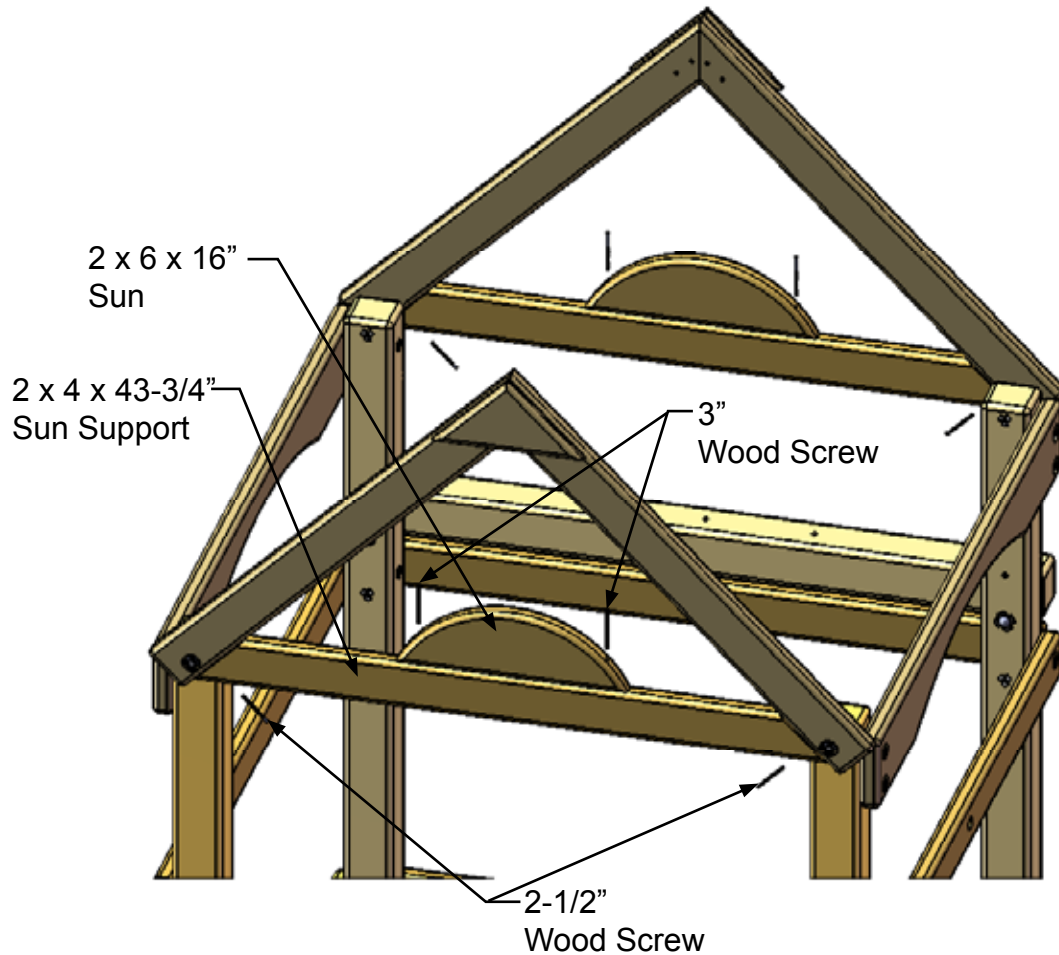

Step 38: Sun Rays

- 1: All the sun ray pieces get installed to the inside surface of the Roof Supports and Sun pieces.
- 2: Place the 5/4 x 2 x 17" Large Ray centered under the peak of the Roof Supports. Attach the Large Ray to the Roof Support and Sun with two 1-1/2" wood screws.
- 3: Arrange six 5/4 x 2 x 13" Small Rays on either side of the Large ray (three small rays per side) as shown below. Attach each Small Ray to the Roof Support and Sun with two 1-1/2" wood screws.
- 4: Repeat substeps 2 and 3 for the other side of the roof.

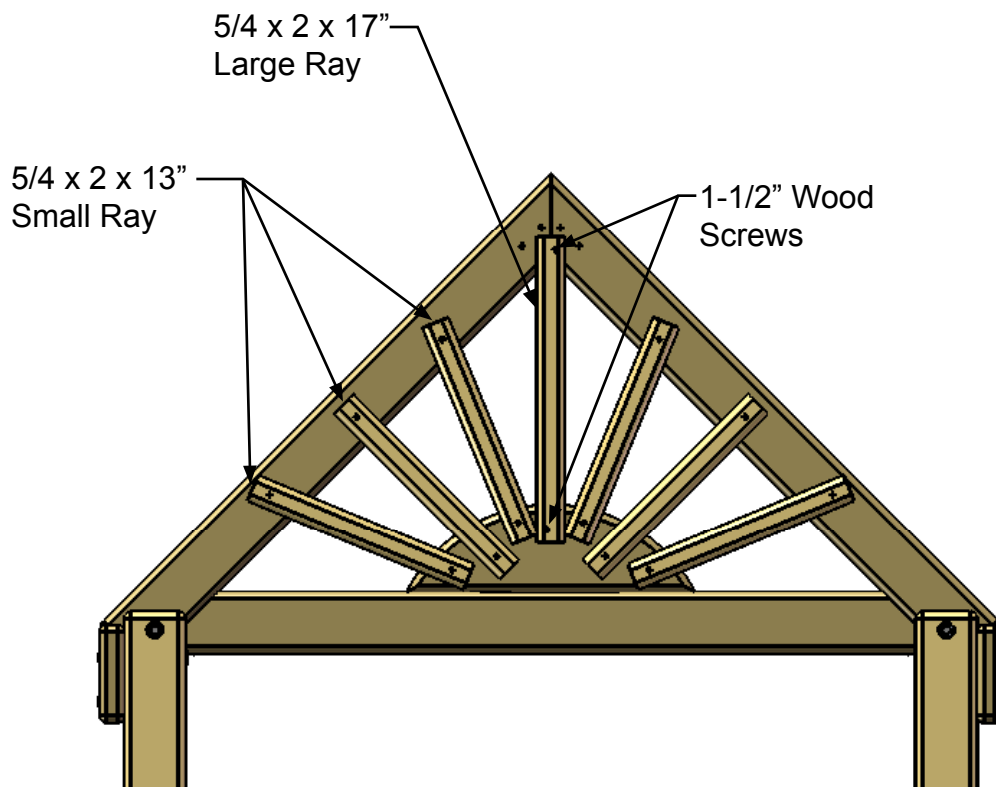

Step 39: Window Supports/Windows

In this step the wood components to attach windows will be installed on the inside of the front of the play set. Go up on top of the deck and look out the front of the play set.

- 1: Attach the 5/4 x 6 x 20" Vertical Window Support in the center with 2" wood screws.
- 2: Attach the 5/4 x 6 x 20" Vertical Window Supports on the sides with 2" wood screws.
- 3: Attach the 5/4 x 2-1/4 x 11-1/2" Horizontal Window Supports at the bottom with 2" wood screws.
- 4: Go to the front of the play set and install the Windows with 1-1/4" wood screws.
- 5: Attach the 5/4 x 2-1/4 x 11-1/2" Horizontal Window Supports at the top with 2" wood screws.

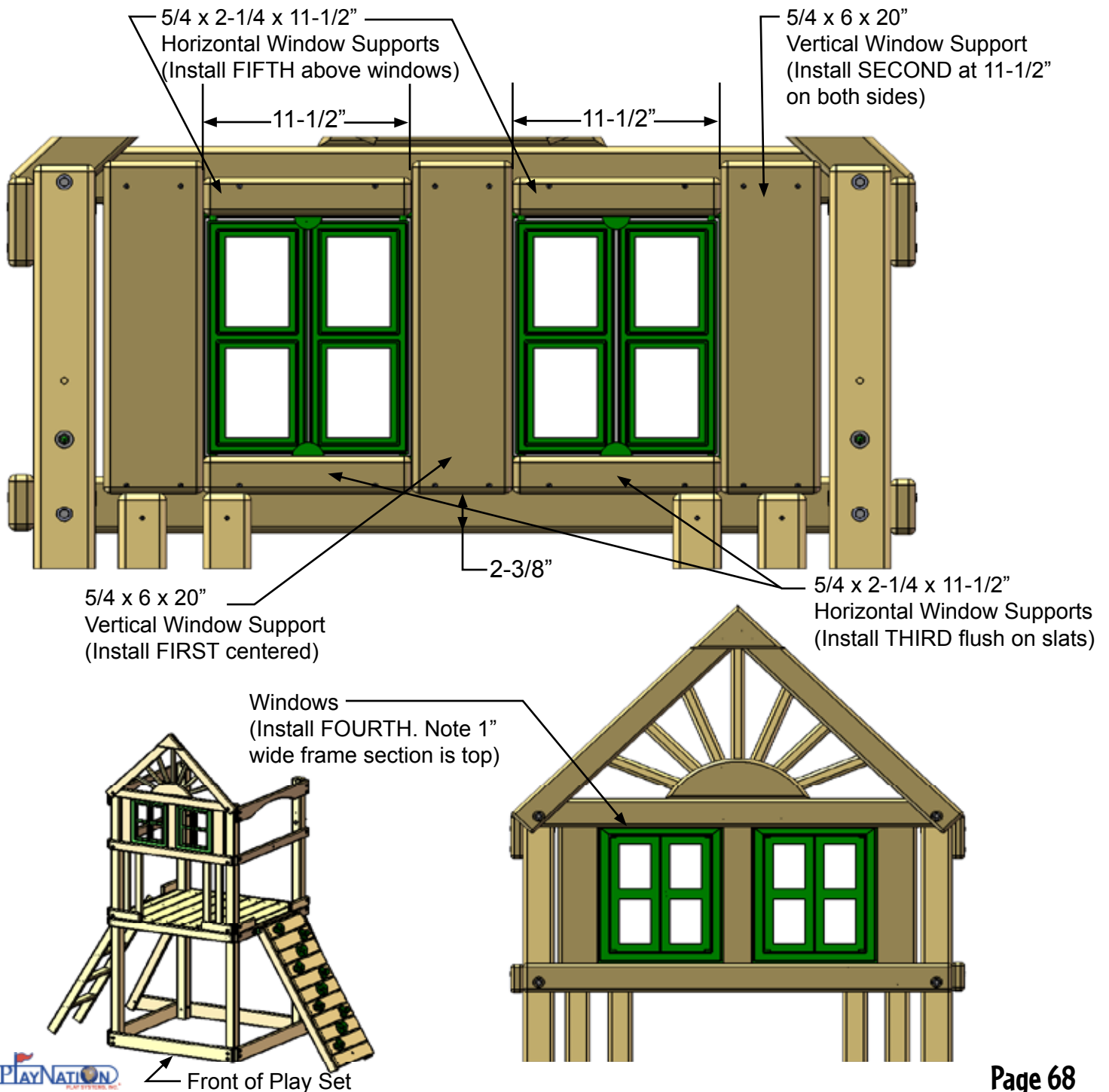

Step 40: Safety Board

This board is meant to be a visual deterrent to prevent children from running through the base of the play set into other children on the swing set.

- 1: Measure 17-1/4" from the top of the Rear Sandbox Board and make a mark on the rear corner posts.
- 2: Place the bottom of a 2 x 4 x 47-3/8" Panel Support with offset holes down on the marks.
- 3: Attach the Panel Support to the rear corner posts with two 5/16" x 3-1/2" lag screws and two 5/16" washers.

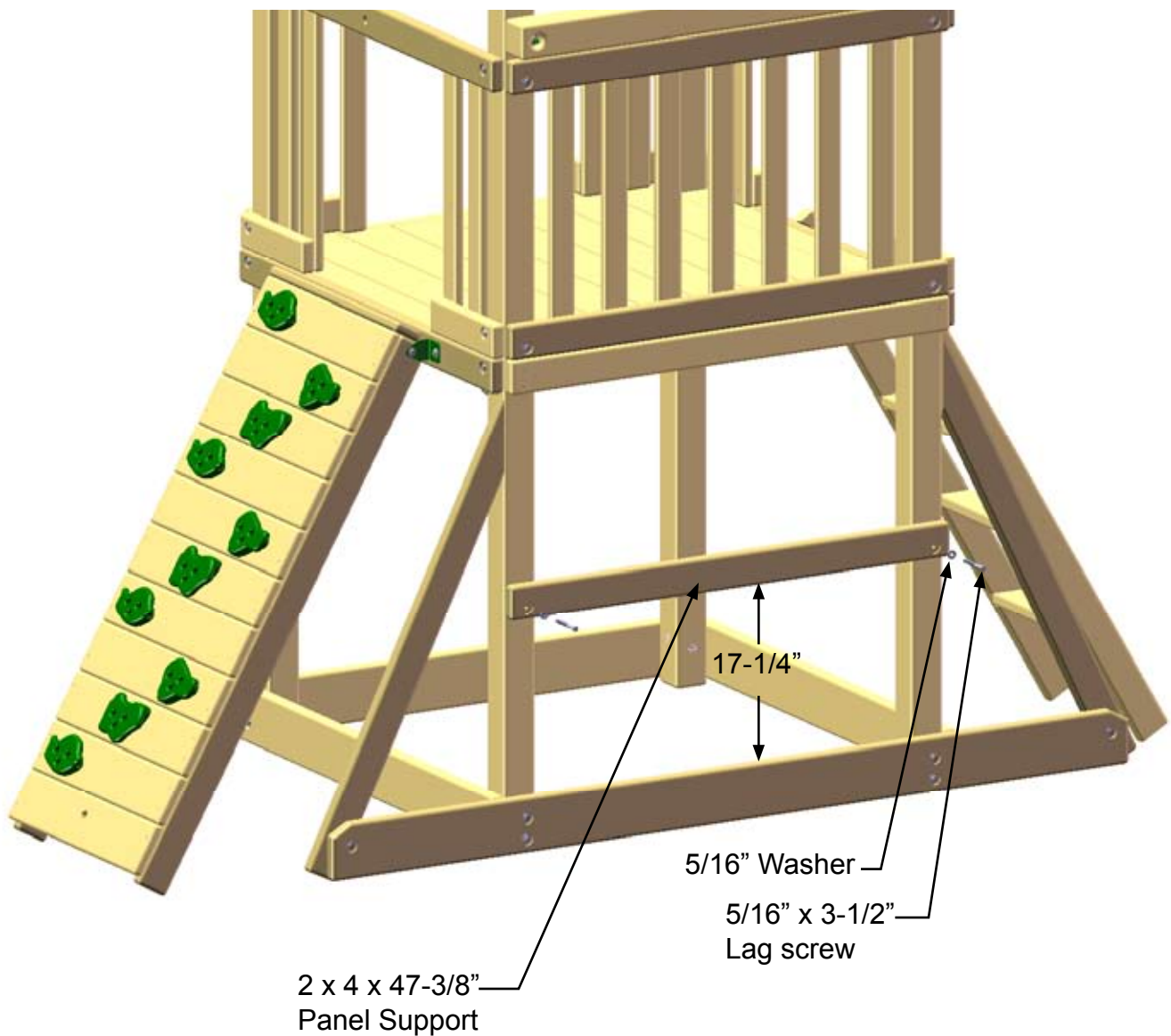

Step 41: Angle Supports

1: Four 2 x 4 x 13" Angle Supports are mounted underneath the deck on the front and back of the fort. (These are called out by the letter "X")

2: Attach each Angle Support (X) to the Deck Support with two 2-1/2" wood screws at the top going through the Deck Support first and then into the Angle Support (X). Attach the bottom of the Angle Support (X) to the corner post with one 2" wood screw and one 3" wood screw.

3: Two 2 x 4 x 13" Angle Supports are mounted underneath the deck on each side of the fort. (These are called out by the letter "Q")

4: Attach each Angle Support (Q) to the Panel Support with two 2-1/2" wood screws at the top going through the Angle Support (Q) first and then into the Panel Support. Attach the bottom of the Angle Support (Q) to the corner post with one 2" wood screw and one 3" wood screw.

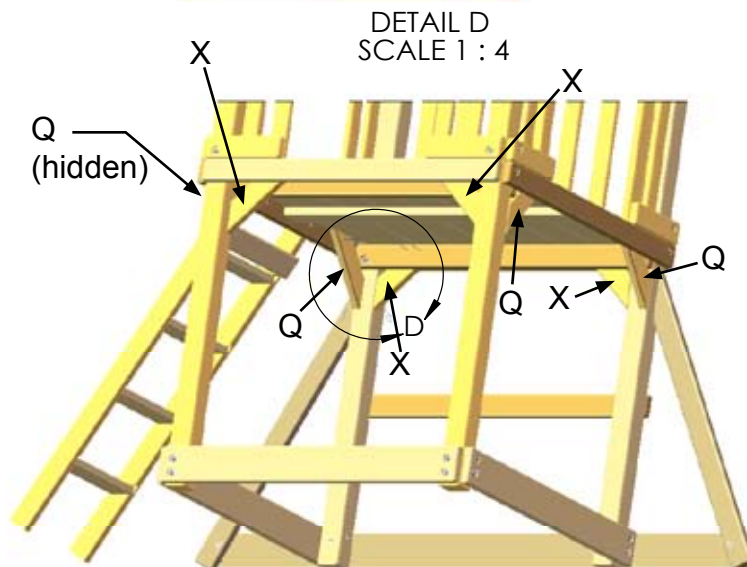
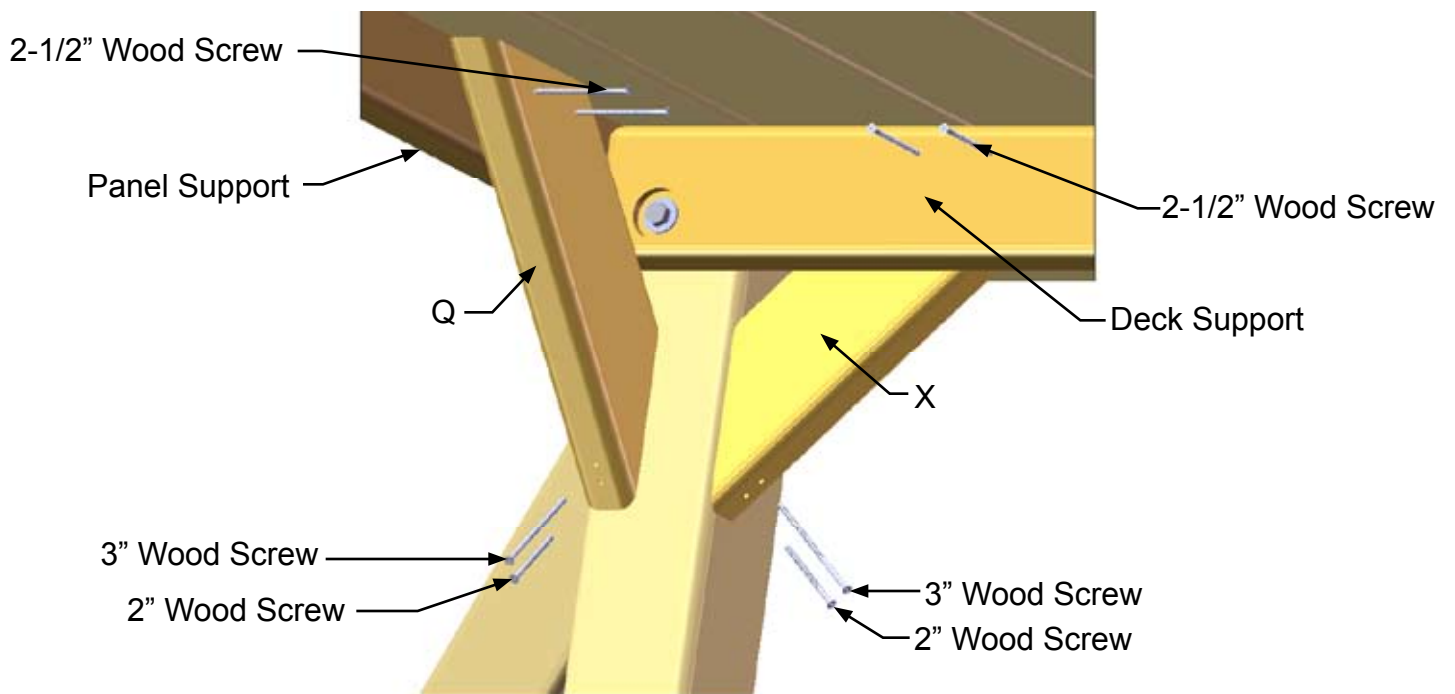

Step 42: Slide

1: Lay Slide on deck with the lip extending onto/over the Deck Boards.

2: Secure the Slide to the Deck Boards with two 1-1/4" wood screws

*** DO NOT OVER TIGHTEN***

3: Once slide is installed DO NOT lift the end of the slide or you may crack it at the screw mounting points.

*** DO NOT PICK UP SLIDE FROM BOTTOM ONCE
INSTALLED***

1-1/4" Wood Screws
DO NOT OVER TIGHTEN



Step 43: Hanging The Swings

- 1: Clip each of the Spring Clips onto the Iron Ductile Swing Hangers, then clip onto the swing chains.
- 2: Use the clips to adjust the height of the swing by clipping onto higher or lower links.
- 3: Count back the same number of links on the opposite side to ensure that the swing is level, and adjust to fit your needs.

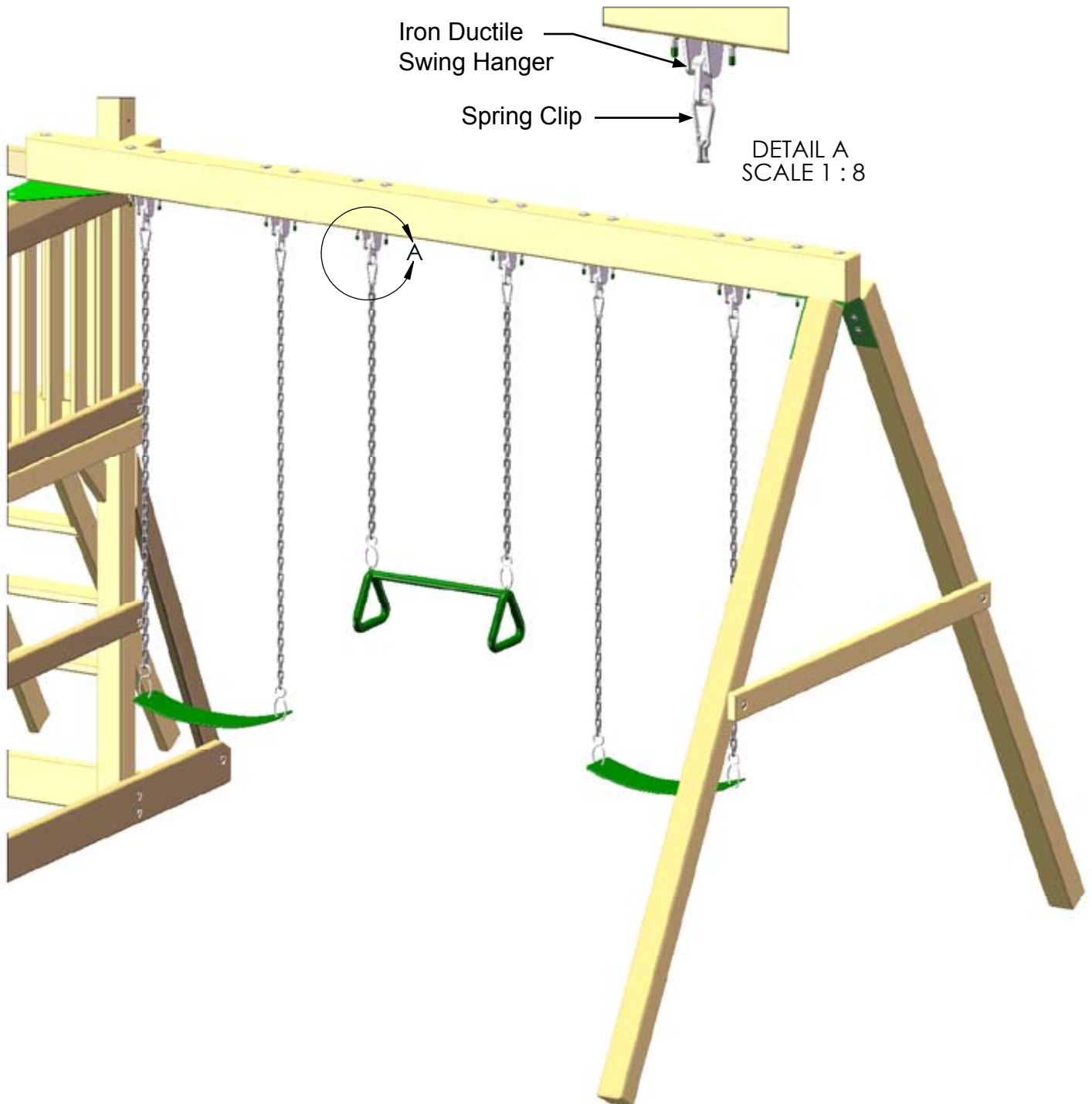

Step 44: Climbing Rope

- 1: Thread one end of the Rope through the hole in the Rock Wall Side Top Panel Board.
- 2: Tie a secure knot on the inside of the Rock Wall Side Top Panel Board.
- 3: Thread the other end of the Rope through the hole in the Bottom Rock Wall Board. Pull the Rope tight and tie a secure knot behind the Bottom Rock Wall Board.
- 4: Note: you may tie two knots in the Rope to aid in climbing if you wish. Do this before performing sub step 3.
- 5: Once the Rope is tied on both ends attempt to wrap the rope around your hand. If the rope wraps around your hand it is too loose. Untie one end and retie the rope until you can no longer wrap it around your hand.

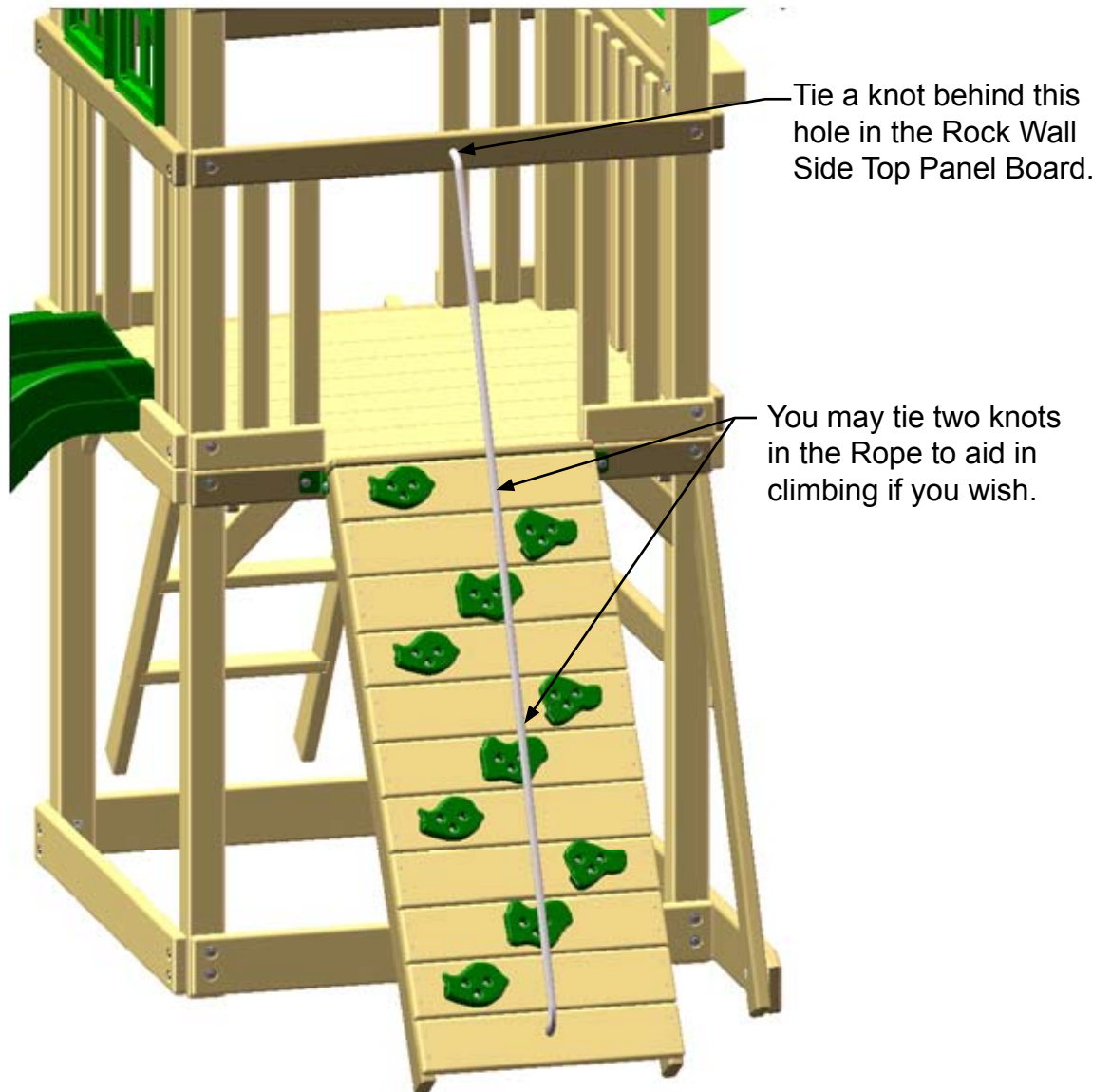

Step 45: Flag Kit

- 1: Place the Flags on the front of the play set centered on the corner posts.
- 2: Attach the plastic base of each Flag to the corner post with the 1/2" phillips head screws provided with the Flags.

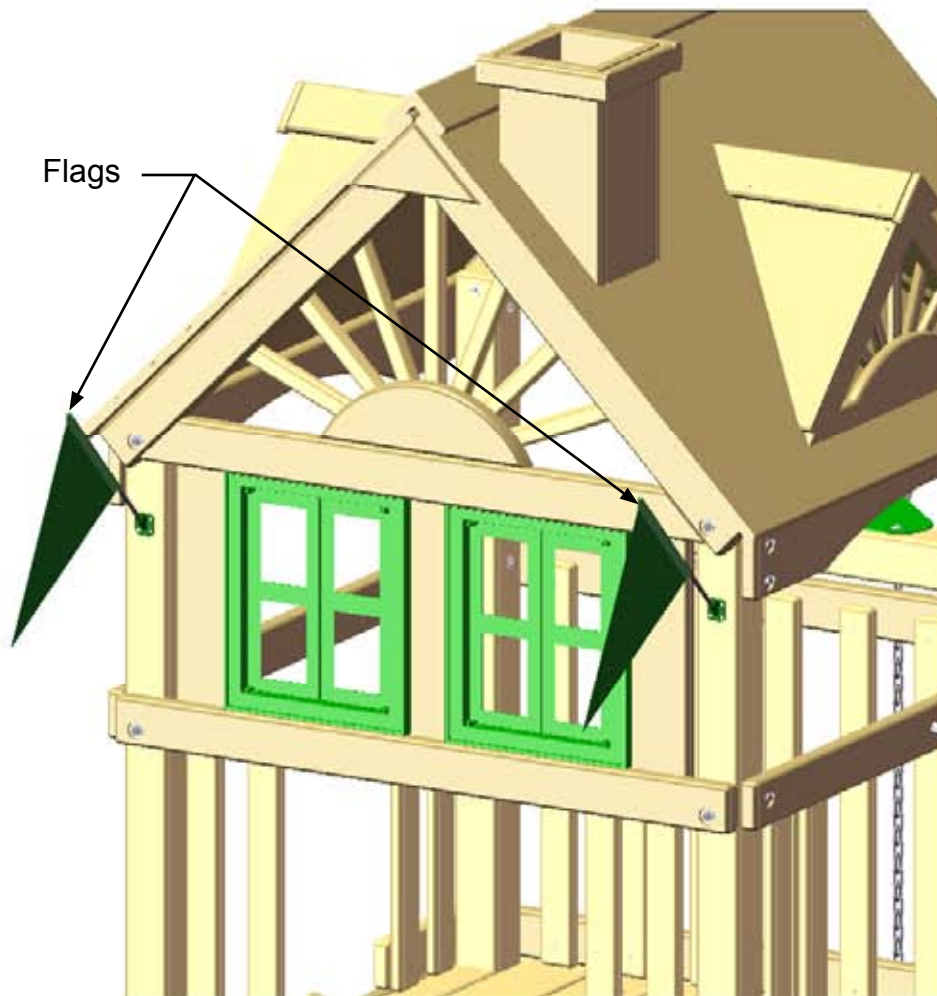

Step 46: Steering Wheel

- 1: Place the Steering Wheel Insert inside the Steering Wheel.
- 2: Use the hardware included (one 3/8 x 2-1/2" lag screw and one 3/8" washer) with the Steering Wheel to mount the Steering Wheel to the end of the Swing Beam. DO NOT over-tighten the lag screw into the Steering Wheel Insert or the Steering Wheel will not turn.
- 3: Place the Steering Wheel Cap over the center of the Steering Wheel and snap into place.

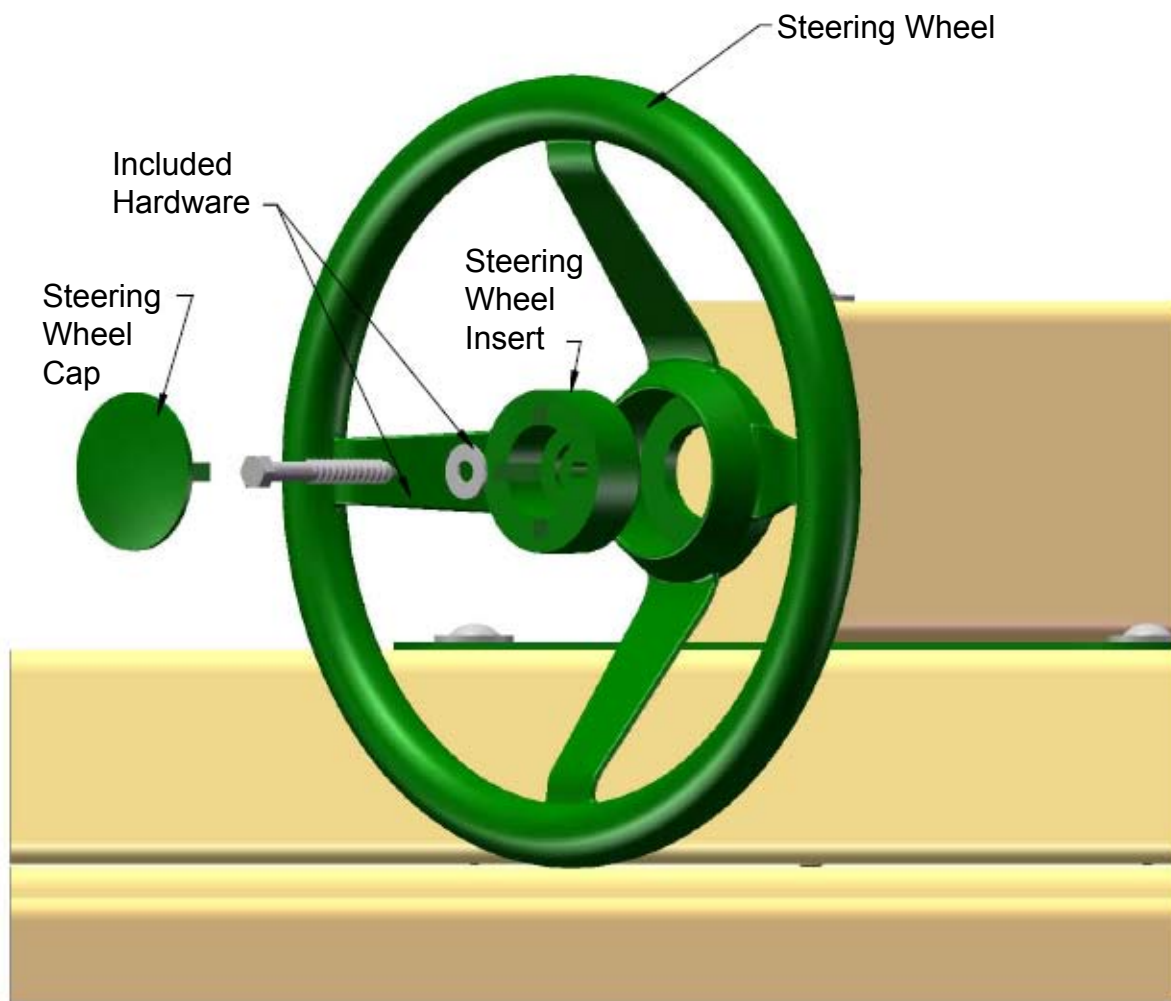

Step 47: Telescope

- 1: Place one of the L-shaped Telescope Mounting Brackets on the Rock Wall Side Top Panel Board.
- 2: Attach the L-shaped bracket with two screws provided with the Telescope.
- 3: Place the base of the Telescope into the cut out area of the L-shaped bracket.
- 4: Attach another L-shaped Telescope Mounting Bracket directly across from the previously installed bracket and secure with the provided hardware.

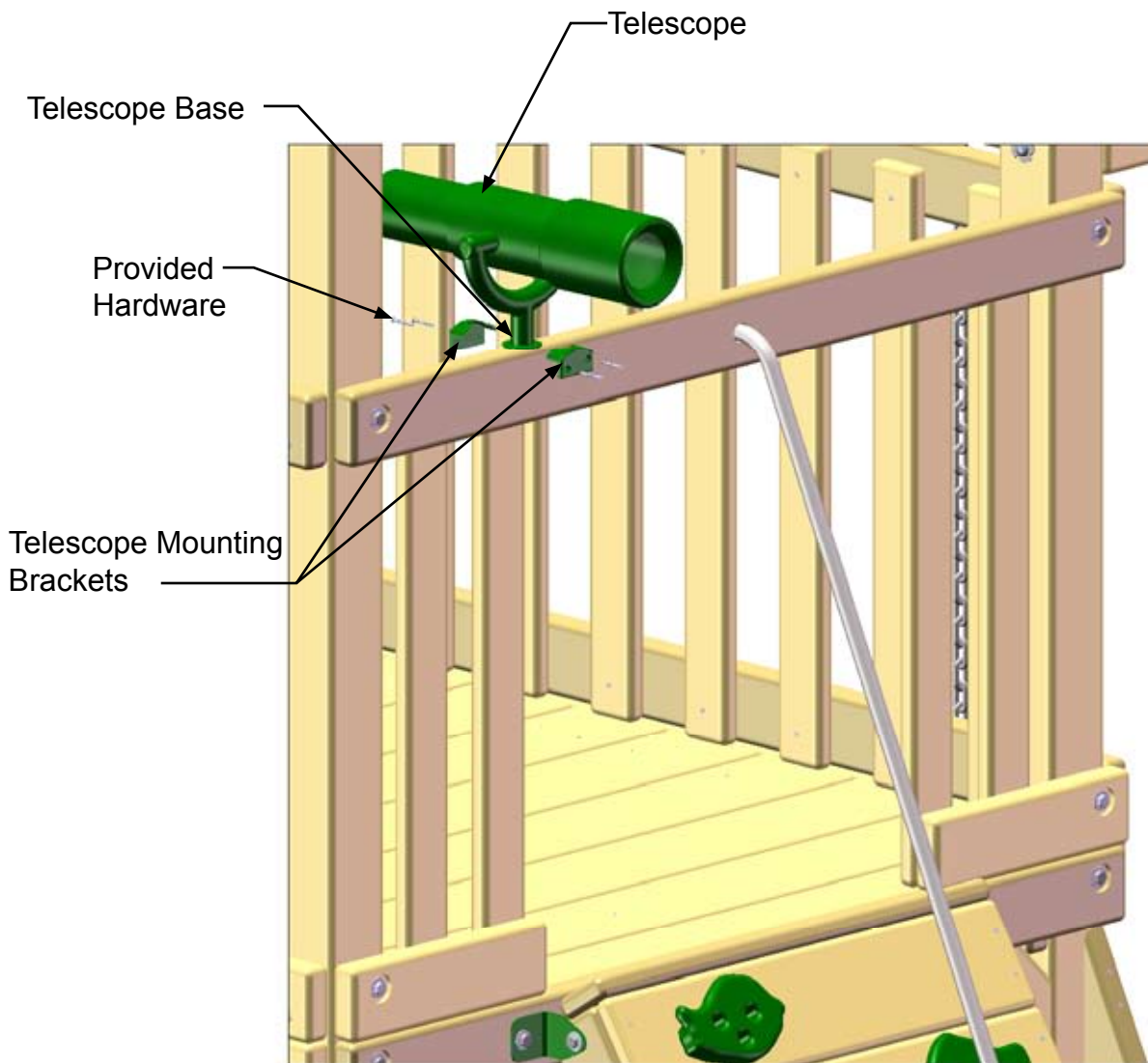

Step 48: Safety Handles

1: Place the Safety Handles centered onto the Panel Slats above the Ladder. Adjust the Safety Handles up or down to suit the needs of your child.

2: Attach each Safety Handle with two 1-1/4" pan head screws and two 1/4" washers provided with each Safety Handle.

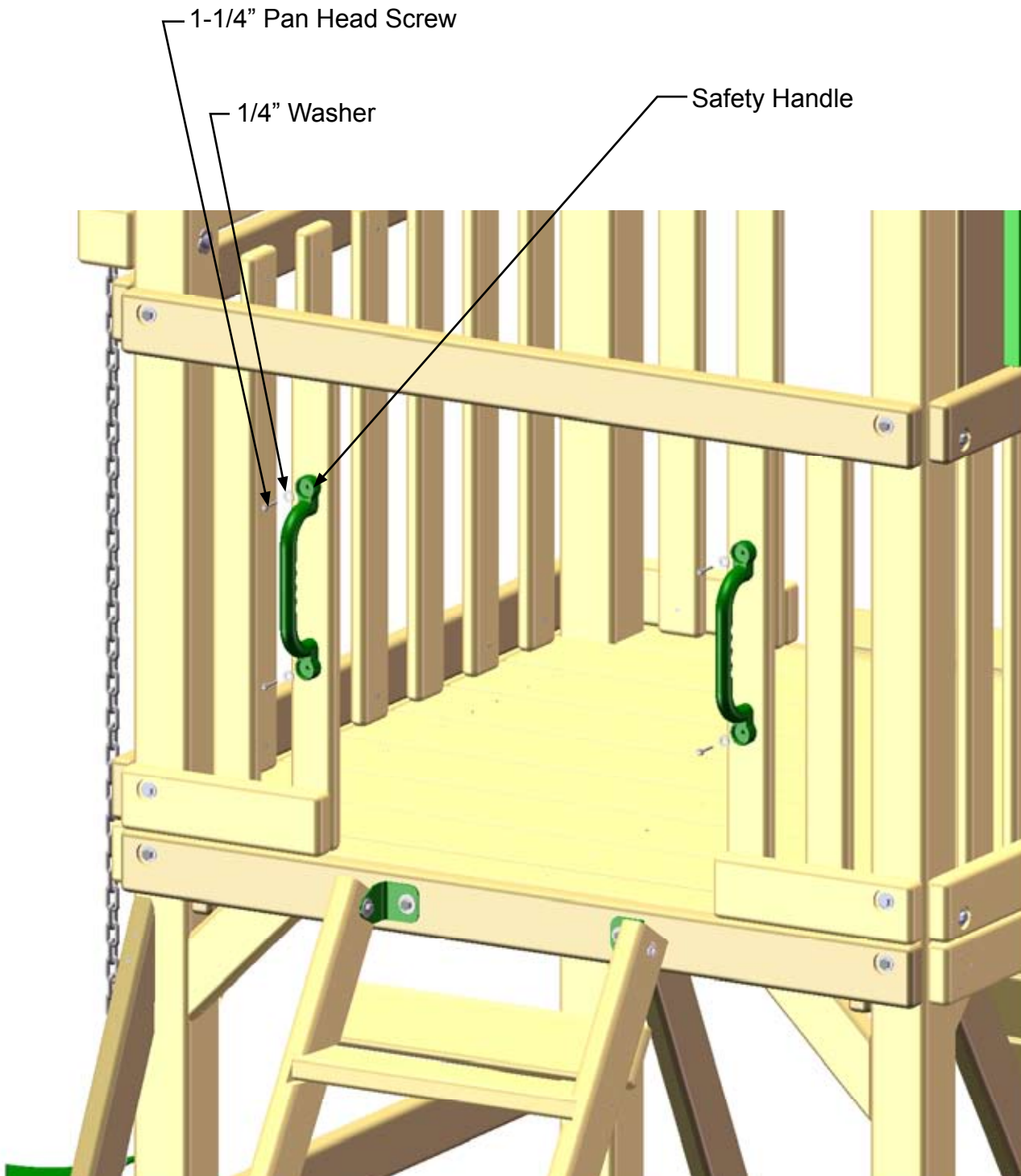

Step 49: Ground Stakes

1: Drive the Ground Stakes into the ground so that approximately 4" of the stake is above ground on the outside of the swing legs.

2: Use 5/16" x 3-1/2" lag screws and 5/16" washers to attach the Ground Stakes to the swing legs.

3: Two more Ground Stakes will be on the inside of the sandbox on the two corner posts closest to the slide. On the inside of the base of the play set drive the Ground Stakes into the ground to a distance that will not interfere with the hex bolts that are installed in the sandbox boards.

4: Use 5/16 x 3-1/2" lag screws and 5/16" washers to attach the Ground Stakes to the corner posts.

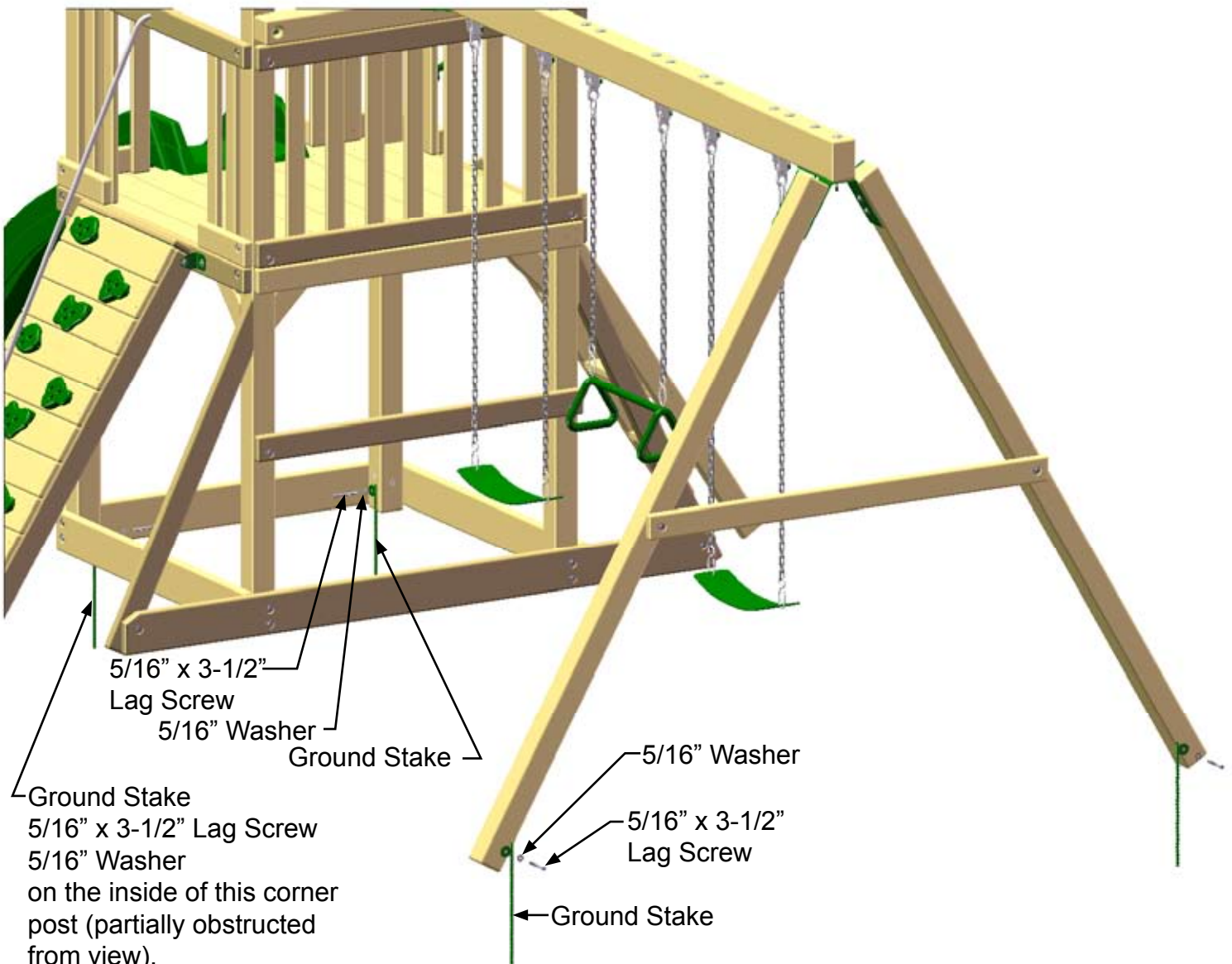

Step 50: Tic Tac Toe

1: Assemble the Tic Tac Toe panel according to the instructions in the box. **IGNORE** Step 6 and Step 7 in the instructions.

2: Attach the two 1-3/8" x 1-5/8" x 10-1/2" Tic Tac Toe Boards to the Green Plastic Brackets with the 1"L phillips head screws provided in the Tic Tac Toe box. **IMPORTANT:** Make sure the Tic Tac Toe Board is mounted to the Green Plastic Bracket observing the 1-5/8" dimension shown below.

3: Center the unit on the panel slats on the swing beam side of the play set.

4: Mount the lower Tic Tac Toe Board 4" above the deck. Attach the Tic Tac Toe Boards to the Panel Slats from outside the play set with #8 x 2"L wood screws.

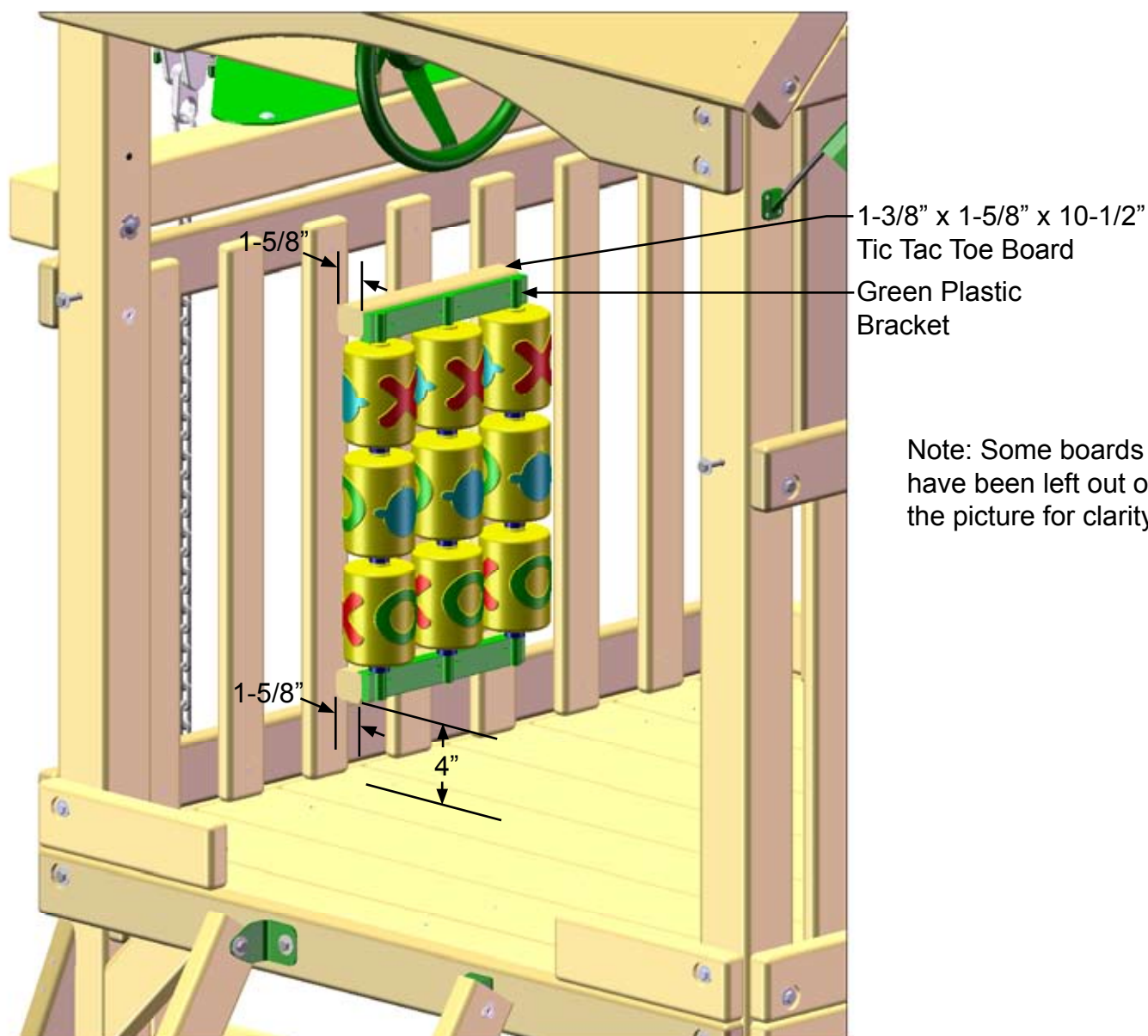

Step 51: PlayNation Name Plate

- 1: Attach the PlayNation Name Plate to the middle of the Swing Beam with two 2" wood screws.
- 2: Your play set is finished! Enjoy your play set!

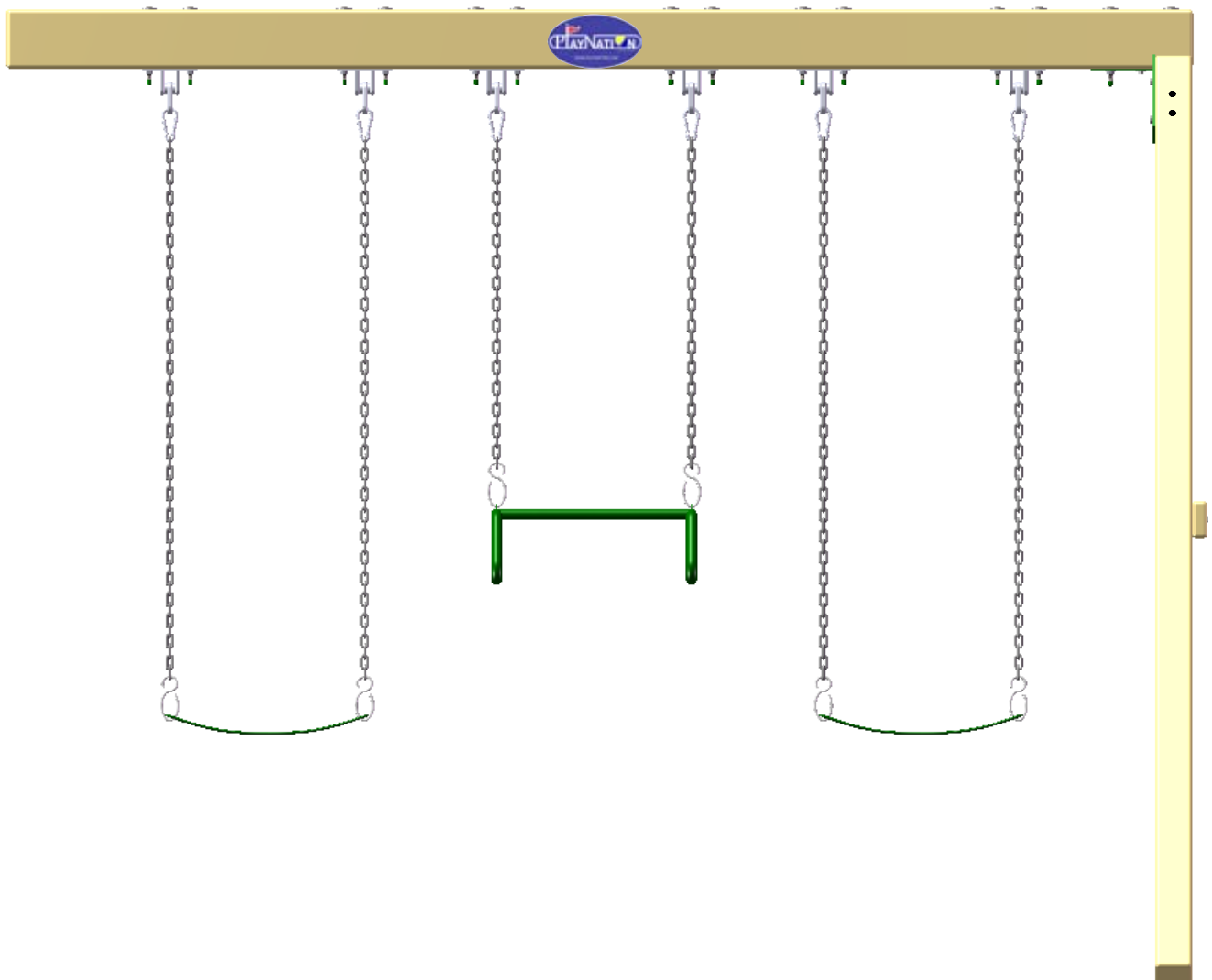

WARRANTY REGISTRATION CARD - Escapade

Name: _____

Address: _____

City, State, Zip: _____

Email: _____

Date of Purchase: _____

Place of Purchase: _____

City, State, Zip: _____

Please, check the boxes below.

Your age?

- 18-25 26-30 31-35 36-40 41-45 46-50 51-55 56-60
 61-65 66+

How old are your children?

- 2-3 4-5 6-7 8+

How would you rate the quality of our product?

- Excellent Above average Average Below average Poor

Would you recommend this product?

- Yes No

Comments:

Thank you for registering with PlayNation Play Systems Inc.™ The information you provided will be kept confidential and will ONLY be used to better serve our customers. Remove this page from the manual and mail to the address below. Thank you from everyone here at PlayNation™!

Mail to:

PlayNation Play Systems Inc.
190 Etowah Industrial Court
Canton, GA 30114
or fax: (678) 880-3329

