



Dane's Den Deluxe

Model: 723

(BOXES: 701N-1, 701N-2, 703N,
705, 721-1, 721-2, 723, 725, Rad
Ride 7 Box & Slide Box)

Copyright © 2015 PlayNation Play Systems, Inc.
All Rights Reserved

190 Etowah Industrial Court
Canton, GA 30114
www.playnation.com



Please inspect and inventory all parts immediately upon accepting delivery. Use the inventory pages in the manual to make sure you have received all necessary parts. The quickest method to get any parts that are missing or damaged is use our “Quick Response Center” located at:

www.playnation.com/support

DO NOT RETURN THIS PRODUCT TO THE RETAILER OR CONTACT THE RETAILER DIRECTLY. THE RETAILER DOES NOT STOCK COMPONENTS.

PLEASE RETAIN ALL INSTRUCTIONS FOR FUTURE REFERENCE. KEEP THEM IN A SAFE PLACE WHERE YOU CAN REFER TO THEM AS NEEDED. CHECK FOR REVISED INSTRUCTIONS AT:

<http://www.playnation.com/manuals.html>

MANUFACTURER'S LIMITED LIFETIME WARRANTY

PlayNation Play Systems, Inc. warrants its Lifetime™ series of swing sets to be free from defects in workmanship and materials, under normal use and conditions, for the lifetime of the product for above ground structural wood components and for two years for all other components (e.g., swings, hardware, plastics, tarps, rope ladder, etc.) except PlayNation's Super Scoop Slides™ and Super Tube Spiral Slides™.

PlayNation warrants its Super Scoop Slides™ and Super Tube Spiral Slides™ to be free from defects in workmanship and materials, under normal use and conditions, for the lifetime of the product.

PlayNation warrants its Regal™, Imperial™, and Empire™ series swing sets to be free from defects in workmanship and materials, under normal use and conditions, for a period of 15 years for above ground structural wood components and for two years for all other components (e.g., swings, hardware, plastics, tarps, rope ladder, etc.).

PlayNation warrants all remaining products, including but not limited to its Free Standing Swing Set, Free Standing Tire Swing, See-Saw, Children's Picnic Table with Umbrella, Play-Zee-Bo™ and spring riders to be free from defects in workmanship and materials, under normal use and conditions, for a period of 1 year. All accessories purchased separate from those included with one of our swing set packages have a one year limited warranty.

Cosmetic imperfections and natural tendencies of wood such as peeling, splintering, warping, seasonal checking or cracking, knots or knot holes, etc. are normal characteristics of all outdoor wooden play equipment and are not covered by this warranty. Checks or cracks in wood components that do not affect the intended function of the part, piece or overall swing set are not covered under this warranty.

Wood rot or decay that develops because the product was installed in an area with poor drainage is not covered under this warranty. Lumber that has been damaged by wood boring bees, or conditions that develop as a result of faulty or improper installation of the product, are not covered by this warranty. Fading of stain, discoloration or mold on any wood part or accessory is not covered by this warranty. Cracks in plastic components, surface rust on hardware and chips on powder coated materials are not considered defects in material as long as they do not affect the functionality or structural integrity of the part or component.

It is the owner's responsibility to maintain the swing set. **This includes but is not limited to staining and sealing the lumber as needed and regular inspection to be sure all hardware is tight.** Instructions for proper maintenance can be found on PlayNation's website. Imperfections or conditions that develop because of a failure to properly maintain the swing set are not covered by this warranty.

PlayNation will, at its discretion, replace any above ground part within the stated warranty period that is defective in workmanship or materials. This decision is subject to verification of the defect, which, at PlayNation's discretion, may be accomplished by submitting photographs or by delivery of the defective part to PlayNation. PlayNation Play Systems, Inc. • 190 Etowah Industrial Ct. • Canton, GA 30114 • 770-704-9300 Monday to Friday 9AM-5PM EST. Any warranty claim must include proof of purchase, including the date of purchase. **In addition, within the first 30 days from the date of purchase, PlayNation will replace any parts discovered to be missing from or damaged in the original packaging.**

This warranty is valid only if the product is used for the purpose for which it was designed and installed at a residential, single-family dwelling. This warranty is void if the product is used in a commercial, institutional or multi-family setting. **This warranty does not cover normal wear and tear or (a) products that have been damaged by acts of God and/or nature, negligence, misuse or accident; (b) products that have been modified or repaired by unauthorized persons; (c) the cost of labor; or (d) the cost of shipping any replacement product or part.**

PLAYNATION DISCLAIMS ALL OTHER REPRESENTATIONS AND WARRANTIES OF ANY KIND, EXPRESSED, IMPLIED, STATUTORY OR OTHERWISE, INCLUDING THE IMPLIED WARRANTIES OF MERCHANTABILITY AND FITNESS FOR A PARTICULAR PURPOSE. PLAYNATION WILL NOT BE LIABLE FOR ANY INCIDENTAL OR CONSEQUENTIAL DAMAGES. This warranty is non-transferable and does not extend to the owners of the product subsequent to the original purchaser. Some states do not allow limitations on implied warranties or exclusion of incidental or consequential damages, so these restrictions may not be applicable to you. This warranty gives you specific legal rights. You may also have other rights which vary from state to state.

IMPORTANT SAFETY GUIDELINES

This product is recommended for use by children ages 3-11. This product is intended for residential use only and not intended for use in any public setting. A safety surface such as mulch or recycled tire should be used under the play set to prevent injury from falls. Also a 6 foot safety zone should be used around the entire play set.

As with any home project, good judgment and respect for power tools will greatly reduce the risk of injury. PlayNation recommends you follow all tool manufacturers' safety guidelines. Always wear eye protection and safety gloves to prevent injury. In several phases of construction two people may be required for lifting and securing of lumber. While the play set is being constructed, please keep children off the equipment until the project is complete. Bolts and screw heads should be checked regularly for tightness. The ground ladder, rope ladder, slide, swings and other areas where children spend a majority of their playtime should be checked more frequently.

PlayNation shall not be liable for incidental, indirect or consequential damages or injuries that result from the building and/or playing on our play sets. Adult supervision is recommended anytime a play set is being used.

WEIGHT LIMITS FOR PLAYNATION PLAYSETS

- FORT PLATFORMS: 800 LBS. TOTAL WEIGHT
- SWING BELT: 225 LBS.
- GLIDER SWINGS: 70 LBS. PER CHILD. UP TO 140 LBS TOTAL WEIGHT.
- TRAPEZE: 125 LBS.
- FULL BUCKET SWING/ HALF BUCKET SWING: 50 LBS.
- HEAVY DUTY TODDLER BUCKET SWING: 85 LBS.
- INFANT SWING: 35 LBS.
- TIRE SWING: 125 LBS. TOTAL WEIGHT
- ROPE LADDER: 75 LBS.
- ROCK WALL: 150 LBS.
- CLIMBING RAMP: 150 LBS.
- MONKEY BARS: 175 LBS.
- ALL SLIDES: 150 LBS.

PlayNation recommends that the weight limits for all components must not be exceeded. Failure to adhere to these and other safety guidelines could result in damage to the play set and injury to the users.

THIS PAGE INTENTIONALLY LEFT BLANK

WARRANTY REGISTRATION

- DANE'S DEN DELUXE -

PlayNation manufactures the finest quality products that are designed for outstanding strength and durability. We back our products with an unparalleled warranty. In the unlikely event that you will need to contact us about covered repairs, we must have a valid Warranty Registration on file.

3 EASY WAYS TO REGISTER	
OPTION 1	Fax this completed form to: (800) 880-3300 OR Mail this completed form to: PlayNation Playsets 190 Etowah Industrial Court Canton, GA 30114
OPTION 2	Complete the online registration form at: http://www.playnation.com/register
OPTION 3	Scan this QR Code with your smart phone to complete the form using your phone 

Where did you buy this product?:

Date of Purchase _____ Store _____ Store City _____ Store State _____

Your registration information:

Name: _____ Email: _____

Address: _____
Street City State Zip

Please select your age? 18-30 31-40 41-50 51+

How old are your children? 2-3 4-5 6-7 8+

How would you rate the quality of this product?
 ★★★★★ Excellent
 ★★★★ Above Average
 ★★★ Average
 ★★ Below Average
 ★ Poor

Would you recommend this product to friends & family? Yes No

Comments: _____

THIS PAGE INTENTIONALLY LEFT BLANK

IMPORTANT – PLEASE READ

Congratulations! You have just purchase one of the finest residential wooden swing sets available today. As with any wooden product that spends its entire life outside, in varying elements, it is important to know what to expect with your new swing set so that your family can enjoy it for many years.

As your swing set acclimates to its new environment, natural characteristics of the wood can show in the form of checks, or “cracks” in the lumber. In almost all cases this is normal and it will not affect the structural integrity of your play set and is not covered under warranty.

KEEPING YOUR PLAYSET LIKE NEW

MUST DO's

The following owner responsibilities are crucial to the safety, integrity and aesthetic appeal of your swing set and may affect the warranty if not adhered to.

WITHIN 60 DAYS

- Check and tighten Hex Bolts/T-nuts, Carriage Bolts/Lock-nuts, and Lag Screws within the first 60 days and then twice annually – once before each season and then once during the season.

WITHIN 90 DAYS

- Apply a **sealant** or **semi-transparent stain with sealant** within the first 90 days of owning the swing set. If applicable state laws allow, an oil based product will penetrate and protect the lumber better than a water based product. Because climate conditions can vary drastically from region to region, we suggest asking the product covering specialists at any number of specialty paint stores or home improvement centers for a product that would work best for your local environment. ** TIP – while the set is new, take a small board from your swing set to the store with you so they can color match the tint of the stain or sealant. Be sure to replace the board when you get home.

SEASONAL REMINDERS

- If your area experiences regular snowfall, remove your fabric tarp/canopy to avoid stretching, sagging or tearing of the material. Store it inside, folded up, and it will be as good as new when winter is over.
- If your area experiences extremely cold temperatures, remove swing belts and other pliable features to prolong the lifespan of these play activities.

OTHER TIPS

- Spray swing hangers with Pam, Mazola or olive oil to stop squeaking; do not use petroleum based products such as WD-40 or motor oil.
- To repel yellow jackets and wasps, use a cotton ball and dab interior wooden corners underneath the play set deck with a liquid dish soap. Avoid using insecticides.
- To speed up the slide wipe the center of slide with wax paper every 2 - 3 weeks.

For additional safety and maintenance guidelines, please visit our website.



IMPORTANT DOCUMENTS

CUSTOMER MUST READ AND RETAIN

Please go to the following links and read important SAFETY information prior to using your new play structure.

<http://www.playnation.com/safety-and-maintenance.html>

<http://www.playnation.com/manuals.html> (Click on your specific model)

<http://www.playnation.com/warranty.html>

NOTE: Your children's safety is our #1 concern. Observing the following statements and warnings reduces the likelihood of serious injury. Please review these safety rules regularly with your children.

WARNING:

Children must NOT use this play set until it has been completely assembled and inspected by an adult to ensure it has been properly installed.

PlayNation Play Systems, Inc.
190 Etowah Industrial Court
Canton, GA. 30114



Model: 723

(BOXES: 701N-1, 701N-2, 703N,
705, 721-1, 721-2, 723, 725,
Rad Ride 7 Box & Slide Box)

REV: 3.10.2015

TABLE OF CONTENTS

Safety Guidelines.....	Pages 4-7
Leveling Fort, General Information and Definitions.....	Pages 7-9
How to Install T-Nuts, Board Identification, Predrill Lag Screw Directions and Swing Beam Loading.....	Pages 10-14
Site Plan, Required Tool List and Kit Contents.....	Pages 15-16
<u>PART I Lower Level</u>	
Hardware, Lumber and Accessory Checklists.....	Pages 18-31
Assembling the Ladder.....	Steps 1-3
Assembling the Rock Wall.....	Steps 4-6
Framing the play set.....	Steps 7-15
Installing Rock Wall Boards.....	Step 16
Installing Tarp Boards, Deck, Roof Supports and Panel Slats.....	Steps 17-23
Swing Beam Assembly.....	Steps 24-30
Tire Swing, Completing Rock Wall.....	Steps 31-33
Installing the Rope Ladder.....	Steps 34-35
Mounting Slide.....	Step 36
Roof and Sunburst Assembly.....	Steps 37-44
Attaching Steering Wheel, Telescope and Safety Handles.....	Steps 45-47
Hanging Swings, Flag Kits, Chimney/Dormers.....	Steps 48-51
Roof Stringers.....	Step 52
Tic Tac Toe, Name Plate and Ground Stakes.....	Steps 53-55

**PLEASE READ OWNER'S MANUAL CAREFULLY
BEFORE STARTING ASSEMBLY!**

TABLE OF CONTENTS

Part II Upper Level

Hardware, Lumber and Accessory Checklists.....	Pages 83-98
Framing the Upper Level.....	Steps 1-4
Connecting the levels with Deck Supports and leveling the Upper Level.....	Step 5
Corner Posts, Safety Bar, Center Post and Center Deck Supports.....	Steps 6-10
Deck Blocks/Deck Support, Center Post/Center Deck Support.....	Steps 11-12
Install Iron Ductile for Punching Bag.....	Step 13
Top and Bottom Panel Boards.....	Steps 14
Deck Filler, Deck Spacers and Deck Boards.....	Step 15
Angle Supports.....	Step 16
Bottom and Top Panel Boards.....	Step 17
Ladder(s), Assembly and Installation.....	Steps 18-19
Center Posts and Bottom Panel Board.....	Step 20
Panel Slats.....	Steps 21-22
Sandbox Seats and Safety Bar.....	Step 23
Roof Assembly.....	Steps 24-28
Sunburst Assembly.....	Steps 29-31
Wall Panel, Windows and Crown.....	Steps 32-34
Assemble Rad Ride 7 Slide and attach to fort.....	Step 35
Attaching the Super Scoop slide.....	Step 36
Install Punching Bag.....	Step 37
Mount Telescope to Upper Level Rear.....	Step 38
Upper Level Safety Handles.....	Step 39
Flag Kits.....	Step 40
<u>Appendix: Chimney and Dormers Instructions.....</u>	Page 139

PLEASE READ OWNER'S MANUAL CAREFULLY BEFORE STARTING ASSEMBLY!

Safety and Maintenance Tips for Your New Play Set:

NOTE: Your children's safety is our #1 concern. Observing the following statements and warnings reduces the likelihood of serious or fatal injury. Please review these safety rules regularly with your children.

- This play set is designed for the use of 4 occupants who have a combined weight not exceeding 800 pounds on the elevated floor, 3 occupants who have a combined weight of 425 pounds on the swing area, for a total Unit capacity of 7 occupants who have a combined weight of 1225. (This weight does not include any picnic table area(s).)
- On-site adult supervision is required.
- Teach children not to walk close to, in front of, behind, or between moving swings or other moving playground equipment.
- Teach children to sit in and never stand on swings
- Teach children not to twist the chains and ropes and not to loop them over the swing beam, since this may reduce the strength of the chain or rope.
- Teach children not to jump from swings or other playground equipment in motion.
- Teach children not to push empty seats. The seat may hit them and cause serious injury.
- Teach children to sit in the center of the swings with their full weight on the seats.
- Teach children not to use the equipment in a manner other than intended.
- Teach children to always go down slides feet first. Never slide headfirst.
- Teach children to look before they slide to make sure no one is at the bottom.
- Teach children to never run up a slide, as this increases their chances of falling.
- The parents should have the children dress appropriately with well-fitting shoes. Loose clothing such as scarves and ponchos should not be worn. Always take off, tie up or tuck in cords and drawstrings on children's clothing. These things can get caught on playground equipment and strangle a child.
- Teach children not to climb when the equipment is wet.
- Teach children to never jump from a fort deck. They should always use the ladder, ramp or slide.
- Teach children to never crawl or walk across the top of monkey bars or swing beam.
- Teach children to never crawl on top of a fort roof or on the outside of a tube slide.
- Verify that any suspended climbing ropes, chains, or cables are secured at both ends and that they cannot be looped around an adult hand.
- Teach children not to attach items to the playground equipment that are not specifically designed for use with the equipment, such as, but not limited to, jump ropes, clothesline, pet leashes, cables and chain as they may cause a strangulation hazard.
- Teach children to never wrap their legs around swing chain.
- Teach children to never slide down the swing chain.
- Teach children to remove their bike or other sports helmet before playing on the playground equipment.
- Teach children to NEVER look at the sun or other bright light through any accessory such as but not limited to a telescope, periscope or binoculars.

WARNING: Children must NOT use this play set until it has been completely assembled and inspected by an adult to insure it has been properly installed and the swing beam legs are anchored.

Safety and Maintenance Tips for Your New Play Set: (continued)

Playgrounds should be inspected on a regular basis. If any of the following conditions are noted, they should be removed, corrected, or repaired immediately to prevent injuries.

- Hardware that is loose, worn or that has protrusions or projections.
- Exposed equipment footings.
- Scattered debris, litter, rocks, or tree roots.
- Splinters, large cracks, and decayed wood components.
- Deterioration and corrosion on structural components, which connect to the ground.
- Missing or damaged equipment components, such as handholds, guardrails, swing seats.
- Check all nuts and bolts twice monthly during the usage season and tighten as required. (But not so tight that you crack the wood) We recommend you check the swing beam and hardware often due to wood expansion and contraction. It is particularly important that this procedure be followed at the beginning of each season.
- Remove plastic swing seats and take indoors or do not use when the temperature drops below 32°F. Reinstall swings and other swing equipment at the beginning of the usage season.
- Oil all metallic moving parts monthly during the usage period.
- Check all coverings for bolts and sharp edges twice monthly during usage season to be certain they are in place. Replace when necessary. It is especially important to do this at the beginning of each new season.
- Check swing seats, ropes, cables and chains monthly during usage season for evidence of deterioration. Replacement should be made of any swing seat that has developed cracks in the plastic seats. Ropes, cables and chains should be removed and replaced if excessive wear is found. Contact us for warranted replacement parts.
- Swing chains, rings, ropes, etcetera should always be fastened to a rotating swing hanger. NEVER attach a chain, ring, rope, etcetera to a stationary hanger such as but not limited to an eye bolt. Severe wear could occur leading to an injury.
- For rusted areas on metallic members such as monkey bars, hand supports brackets, etc.; sand and repaint, using a non lead-based paint meeting the requirements of Title 16 C.F.R. Part 1303. These requirements are available at: <http://www.cpsc.gov/>
- Inspect wood parts monthly. The grain of the wood sometimes will lift in the dry season causing splinters to appear. Light sanding may be necessary to maintain a safe playing environment. If you are treating your play set with stain regularly, it will help prevent severe checking/splitting and other weather damage.
- Once or twice a year, depending on your climate conditions, you must apply some type of protection (sealant) to the wood of your unit. Prior to the application of sealant, lightly sand any “rough” spots on your set. Please note this is a requirement of your warranty.
- Creating and maintaining the play set on a level location is very important. As your children play, your play set will slowly dig its way into the soil, and it is very important that it settles evenly. Make sure the play set is level and true once each year or at the beginning of each play season.
- Twice a month during the usage season rake the playground protective surfacing materials to prevent compaction and maintain appropriate depths. Replace the protective surfacing materials as required.
- Disposal Instructions: When the play set is no longer desired, it should be disassembled and disposed of in such away that no unreasonable hazards will exist at the time the play set is discarded.

Play Set Surfacing Recommendations:

Below are some of the recommendations that the U.S. Consumer Product Safety Commission (CPSC) offers from its Handbook for Public Playground Safety. The guide can be downloaded in full at www.cpsc.gov/cpscpub/pubs/325.pdf

1. Protective Surfacing - Since almost 60% of all injuries are caused by falls to the ground, protective surfacing under and around all playground equipment is the most critical safety factor on playgrounds.

Certain manufactured synthetic surfaces also are acceptable; however, test data on shock absorbing performance should be requested from the manufacturer.

Asphalt and concrete are unacceptable. They do not have any shock absorbing properties. Similarly, grass and turf should not be used. Their ability to absorb shock during a fall can be reduced considerably through wear and environmental conditions.

Certain loose-fill surfacing materials are acceptable. Surfacing materials are acceptable, such as the types and depths shown in the table.

Fall Heights and Materials

Type Of Material	6 in. depth	9 in. depth	12 in. depth
Double-Shredded bark mulch	6' Fall Height	10' Fall Height	11' Fall Height
Wood Chips	6' Fall Height	7' Fall Height	12' Fall Height
Fine Sand	5' Fall Height	5' Fall Height	9' Fall Height
Shredded Tires*	10-12' Fall Height	N/A	N/A
Fine Gravel	6' Fall Height	7' Fall Height	10' Fall Height

*This data is from tests conducted by independent testing laboratories on a 6-inch depth of uncompressed shredded tire samples produced by four manufacturers. The tests reported critical heights, which varied from 10 feet to greater than 12 feet. It is recommended that persons seeking to install shredded tires as a protective surface request test data from the supplier showing the critical height of the material when it was tested in accordance with ASTM F1292.

It should be recognized that all injuries due to falls cannot be prevented no matter what surfacing material is used.

2. Fall Zones - A fall zone, covered with a protective surfacing material, is essential under and around equipment where a child might fall. This area should be free of other equipment and obstacles onto which a child might fall. Stationary climbing equipment and slides should have a fall zone extending a Minimum of 6' in all directions from the perimeter of the equipment.

Swings should have a fall zone extending a minimum of 6' from the outer edge of the support structure on each side. The fall zone in front and back of the swing should extend out a minimum distance of twice the height of the swing as measured from the ground to the top of the swing support structure.

LEVELING YOUR FORT DURING ASSEMBLY

- Complete the steps which will be the basic frame of the fort. {i.e. four corner posts with base (sand box boards) and deck supports}
- Position in the most level area chosen for the play set, keeping in mind the location and size of the swing beam, ladder, slides, etc. that extend off the fort.
- Once the frame is in the final position, check for vertical and horizontal levelness to determine which side(s) will need to be dug into the ground to level the play set.
- With a shovel, score the ground around the outside edges of the sandbox boards on the 'high' side of the fort. This is the area that will be dug in. Make sure to score deep enough; the scored lines will be your digging template.
- Push the frame off and away from the scored area, far enough to dig and remove dirt to reach the appropriate depth.
- Dig a channel along the scored line(s) for the base of the fort (corner post and sandbox boards) to rest into. Dig the channel(s) to the same level depth. The bottom of the channel(s) should be level to each other so your frame doesn't teeter or rock because the channel(s) are uneven.
- Once you have removed enough grass and dirt, slide/push the frame into the channel(s). Place a level on the vertical and horizontal boards of the frame to determine if enough soil, or too much, was removed.
- Repeat this process until the basic frame is plumb and level and in its final position before completing the rest of the assembly.
- Measure to make sure fort is square.

Important: if you require a channel depth of more than 6", then we recommend you have your play set area professionally graded before completing assembly.

Example Play area:

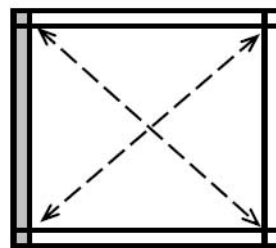
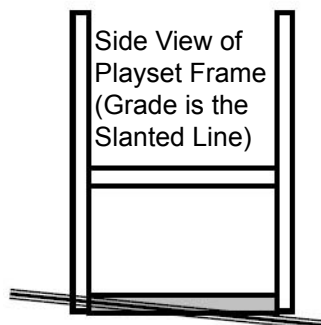

The diagonal measurements should be the same from corner post to corner post. If not, adjust corner posts so that the distance is equal.

■ = Area to be scored and channeled for levelness

General Info to Review Before Installation

- Depending on your experience, assembly of the playset can take as little as 6 hours up to 24 hours, depending on size, after inventory of parts; therefore, we recommend you set aside a full two days for assembly.
- Identify all of the parts for your play set. Empty each box and lay out boards so you can see each part. Your instruction book will have detailed drawings that will make it easy for you to recognize individual parts. Keep all hardware and metal parts separate from wooden pieces.
- After everything is laid out, check carefully to ensure all parts are present. Make sure there are no broken boards.
- Find an area to sort your hardware. It is best to open the hardware on a solid surface so that you do not lose any pieces in the grass. This will save time and familiarize you with all the different pieces in the hardware bag.
- Important note: Wood has some natural defects such as knots, surface cracks, etc... We reject parts that are structurally defective. We use a high quality lumber in our structures; however, you should inspect each part for splinters or rough spots and sand them smooth to prevent injury.
- After familiarizing yourself with all of the components, read all instructions thoroughly. Reading instructions after you have studied the parts will help you understand the installation process, and help to eliminate unnecessary mistakes.
- Pay close attention to the diameter and length of each bolt and screw.
- Never tighten hardware completely at first. It helps to have some adjustment for bolt alignment while you are attaching parts together. After everything is square, tighten each joint.
- After the main unit is assembled it is critical that the floor is level and square. If the main frame is not level, the walls and floor will be out of square.
- After you complete installation, make sure every bolt, screw, and nut is tight, and every board is secure. Wood will expand and contract with the seasons.
- Place the set on level ground, not less than 6 feet from any structure or obstruction such as a fence, garage, house, overhanging branches, laundry lines, or electrical wires.

This page is a list of definitions and explanations used throughout our instructions to aid you in the assembly of your play set.

Offset Holes- Throughout the installation procedures we will refer to parts with offset holes. This refers to the orientation of the holes on the board. An offset hole is one that is closer to one side than it is the other or in other words, it is not centered on the board. In the procedures you will be instructed to attach the boards with the holes offset up or with the holes offset down. This refers to which side of the board the hole/holes should be closer to. Offset holes up= hole/holes will be closer to the top of the board. Offset holes down= hole/holes will be closer to the bottom of the board. Note: some parts do not have offset holes, but instead the holes are on center. Therefore there will not be any reference on how to offset these parts.

EXAMPLE OF OFFSET HOLES UP

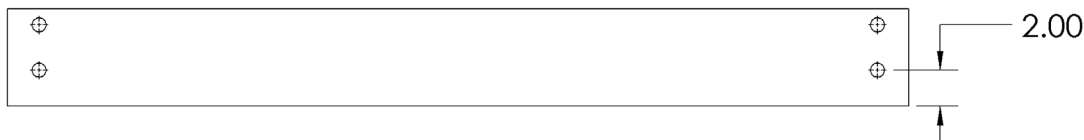

EXAMPLE OF OFFSET HOLES DOWN



Counter-sunk holes - Many of the parts that will be used have counter-sunk holes. A counter-sunk hole is one that surrounds one side of a through hole, but does not extend through the wood it's self. When using a counter-sunk hole the bolt will be inserted through the through hole and either the head of the bolt and washer or nut and washer will occupy the counter sunk hole.

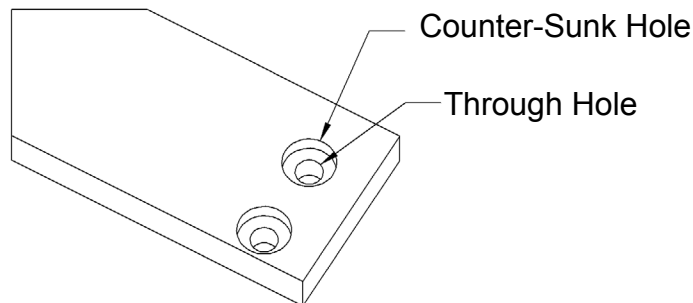

Lag Screws- Lag screws are used in the construction of our play sets to enhance the structural integrity of the unit. There will not be predrilled holes in the post for lag screw installation. Lag screws are self-tapping, though if you are using a manual socket wrench it may be advantageous to pre-drill a hole first. Instructions for this are provided on a separate page in the front of the manual. Be sure to tighten the lags completely when driving them in by hand. Power tools such as a heavy duty impact driver or large power drill should have enough torque to drive in the lag screws, but make sure not to over tighten as this can cause the threads to “strip out” in the post.

Common Installation Practice Installing T-nuts

When installing T-nuts into the wood, use a smooth faced hammer to set the face of the T-nut flush into the wood.

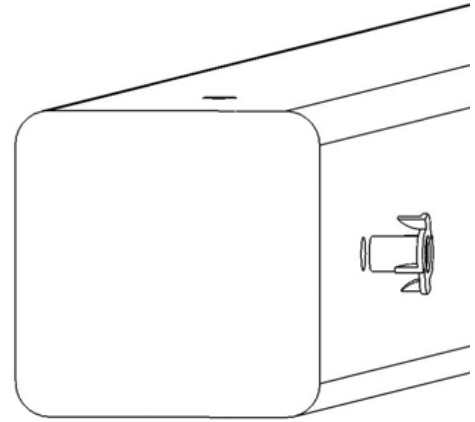
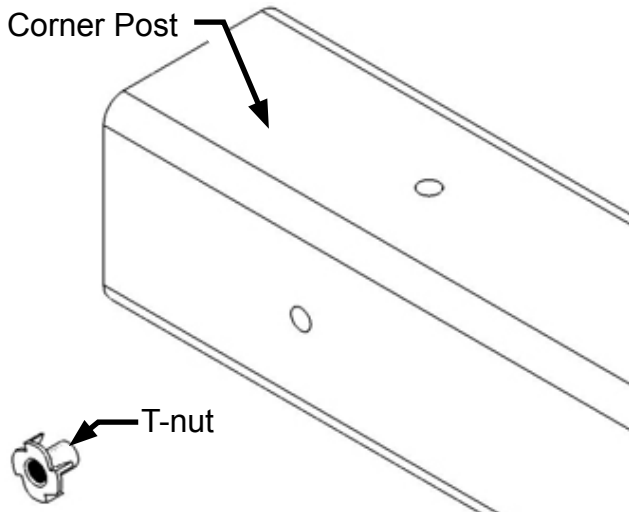

Insert the barrel of the T-nut into the predrilled hole. Using a smooth faced hammer, drive the T-nut until the face of the T-nut is flush to the wood.

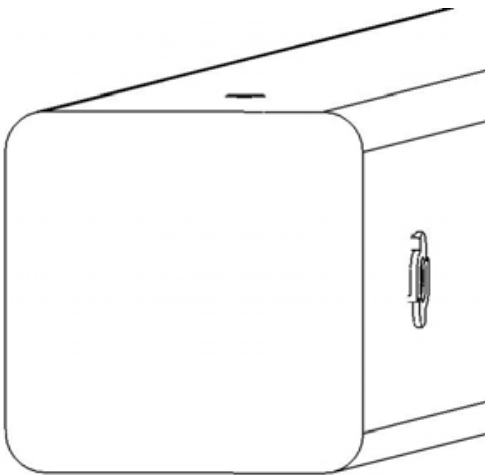

This picture shows the T-nut inserted and installed flush to the wood.



This picture shows an end view of the T-nut installed flush to the wood.

WARNING: DO NOT EMBED THE TOP OF THE T-NUT INTO THE FACE OF THE WOOD

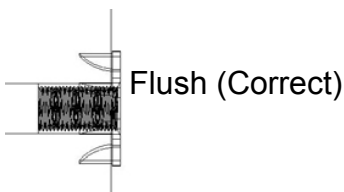

Cross Section end view, you are looking at an X-ray view of the post and T-nut. The barrel of the T-nut is in the corner post the line is the face of the wood.

HOW A T-NUT WORKS

THE FIRST STEP IN OUR ASSEMBLY INSTRUCTIONS IS TO INSERT T-NUTS INTO THE CORNER POSTS. A T-NUT IS A FASTENER WHICH IS THREADED ON THE INSIDE AND IT FUNCTIONS JUST LIKE A STANDARD HEX NUT. YOU INSERT THE T-NUTS INTO THE PREDRILLED HOLES IN THE CORNER POSTS.

THE T-NUT HAS A BARREL SHAPED END WHICH GOES INTO THE HOLE IN THE CORNER POST. THE T-NUT ALSO HAS AN FLANGE SHAPED END WITH TEETH. THE TEETH PENETRATE INTO THE CORNER POST WOOD TO PREVENT THE T-NUT FROM SPINNING WHEN YOU TIGHTEN THE HEX HEAD BOLT.

SHOWN BELOW YOU WILL SEE THE T-NUT IS HAMMERED INTO THE CORNER POST ON THE BACK SIDE. THE BOARD IS BEING ATTACHED ON THE FRONT SIDE OF THE CORNER POST.

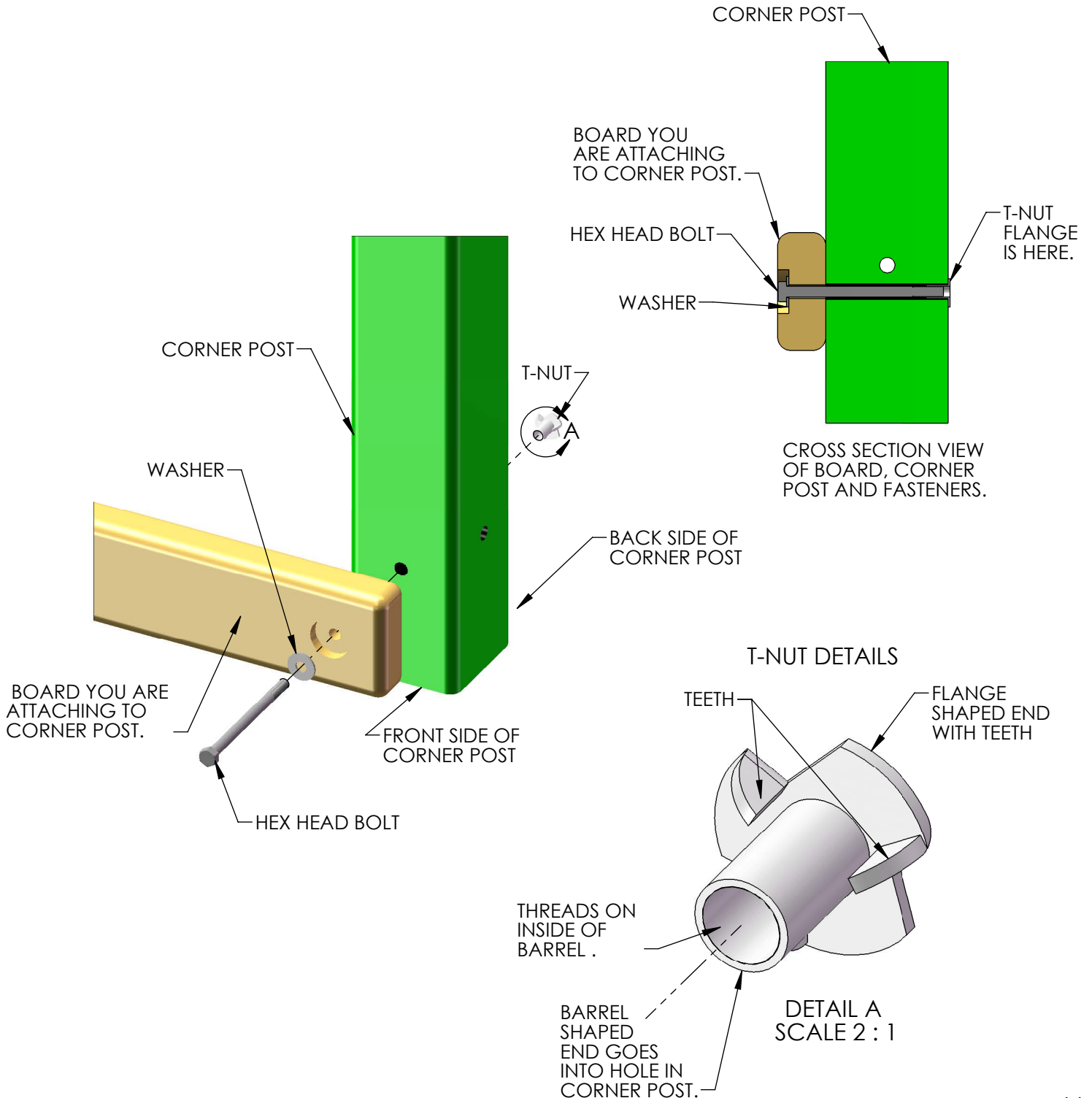

BOARD IDENTIFICATION

1. On the end of each board there should be a small white tag that is stapled into place.
2. This white identification tag displays the thickness, width, length and an abbreviated description of the part.

Example: a tag reads "2-4-3600-BPB"

- The 2 is the thickness of the board. "Nominal Lumber" at a home center will measure 1-1/2" for the thickness. We "remill" that lumber to 1-3/8" thick.
- The 4 is the width of the board. "Nominal Lumber" at a home center will measure 3-1/2" for the width. We "remill" that lumber to 3-3/8" wide.
Note: sometimes the width will be smaller than 3-3/8" because:
A) We need the width of the part to fit into a certain area of the play set.
B) We need the designation to be simple.
- The 3600 is the length of the board. It means the board is 36 inches long. If the code were 3625 then the board is 36-1/4" in length.
- The "BPB" abbreviation stands for "Bottom Panel Board". The wood part bill of materials in the instructions has a description which will match the abbreviation closely.
- In the event that there is no tag on a wood part measure the part then:
A) Use the measurements and compare them to the wood list at the front of the instructions to identify it.
B) Look at the holes on the wood part and compare them to the pictures in the wood list.
C) Look to see if the holes are centered or if they are offset up or offset down.
This should help you identify any parts that have missing tags. In the event that you cannot identify a board please email us for assistance.

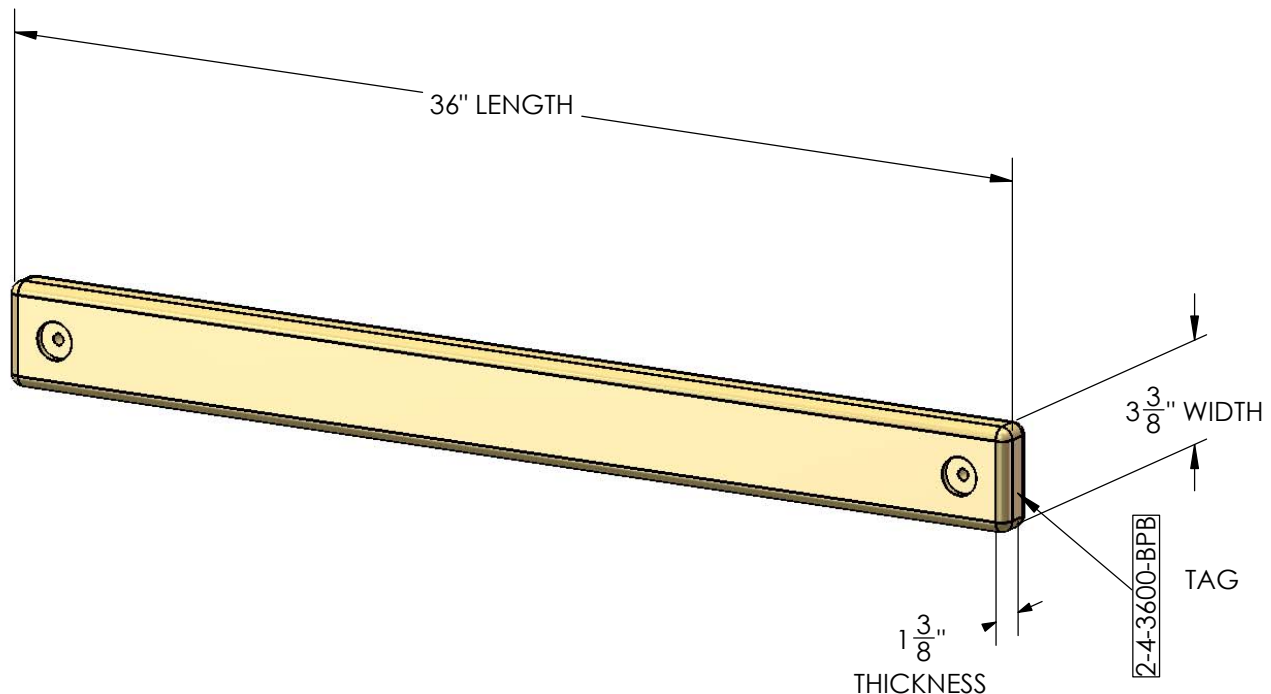

PRE-DRILL LAG SCREW DIRECTIONS

Pre-drilling holes for lag screws will make it easier to drive the screws in by hand. "Jobber" length drill bits are available in sizes that are longer than standard drill bits and those are ideal for the job. When using the drill bit you will have to "spot" drill the post and then remove the board you are attaching to finish drilling the hole.

Pay attention to the *DIAMETER* of the lag screw you are installing. Your playset may come with two different diameter lag screws. Each diameter will require a different size drill bit. When installing lag screws **DO NOT OVERTIGHTEN.**

LAG SCREW DIAMETER	DRILL BIT SIZE
5/16" DIAMETER	9/64"
3/8" DIAMETER	11/64"

Example: 3/8" diameter x 3-1/2" lag screw

This would be like the 2 x 4 board installation shown below. Place the board into position. Spot Drill through the holes in the 2 x 4 board into the corner posts with an 11/64" drill bit. Remove the 2 x 4 board. Continue to drill the holes to a total depth of 2-5/16" as shown at the right. Install the 2 x 4 board.

Example 5/16" diameter x 3-1/2" lag screw

This would be like the 2 x 4 board installation shown below. Place the board into position. Spot Drill through the holes in the 2 x 4 board into the corner posts with an 9/64" drill bit. Remove the 2 x 4 board. Continue to drill the holes to a total depth of 2-5/16" as shown at the right. Install the 2 x 4 board.

Example 3/8" diameter x 5" lag screw

This would be like the 4 x 4 board installation shown below. Place the board into position. Spot drill through the holes in the 4 x 4 board into the corner posts with an 11/64" drill bit. Remove the 4 x 4 board. Continue to drill the holes to a total depth of 2-13/16" as shown at the right. Install the 4 x 4 board.

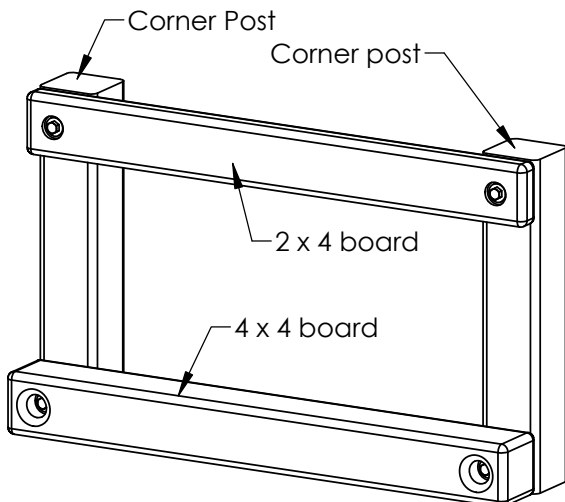
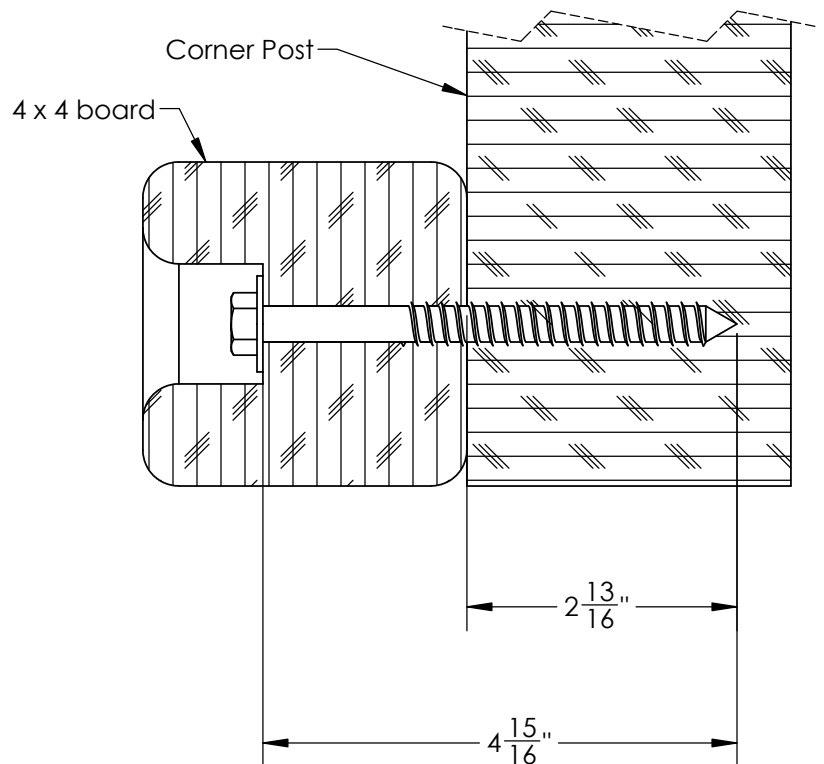
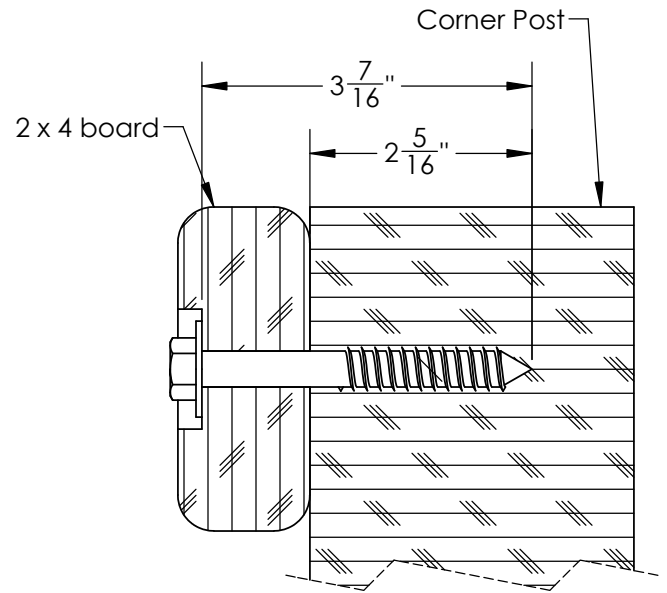

SWING BEAM LOADING

Weight Limits for Accessories:

The weight limit for a Swing Belt is 225 lbs. (Although 150lbs is the maximum recommended swinging weight capacity for the swing position.)

The weight limit for a Trapeze Bar is 125 lbs.

Maximum Allowable swinging weight for a three position swing:

- 1) The maximum allowable swinging weight at each Swing Belt position is 150 lbs.
- 2) The maximum allowable swinging weight at the Trapeze position is 125 lbs.
- 3) The MAXIMUM SWING BEAM LOAD IS 425 lbs.

MAXIMUM SWING BEAM LOAD IS 425 LBS.

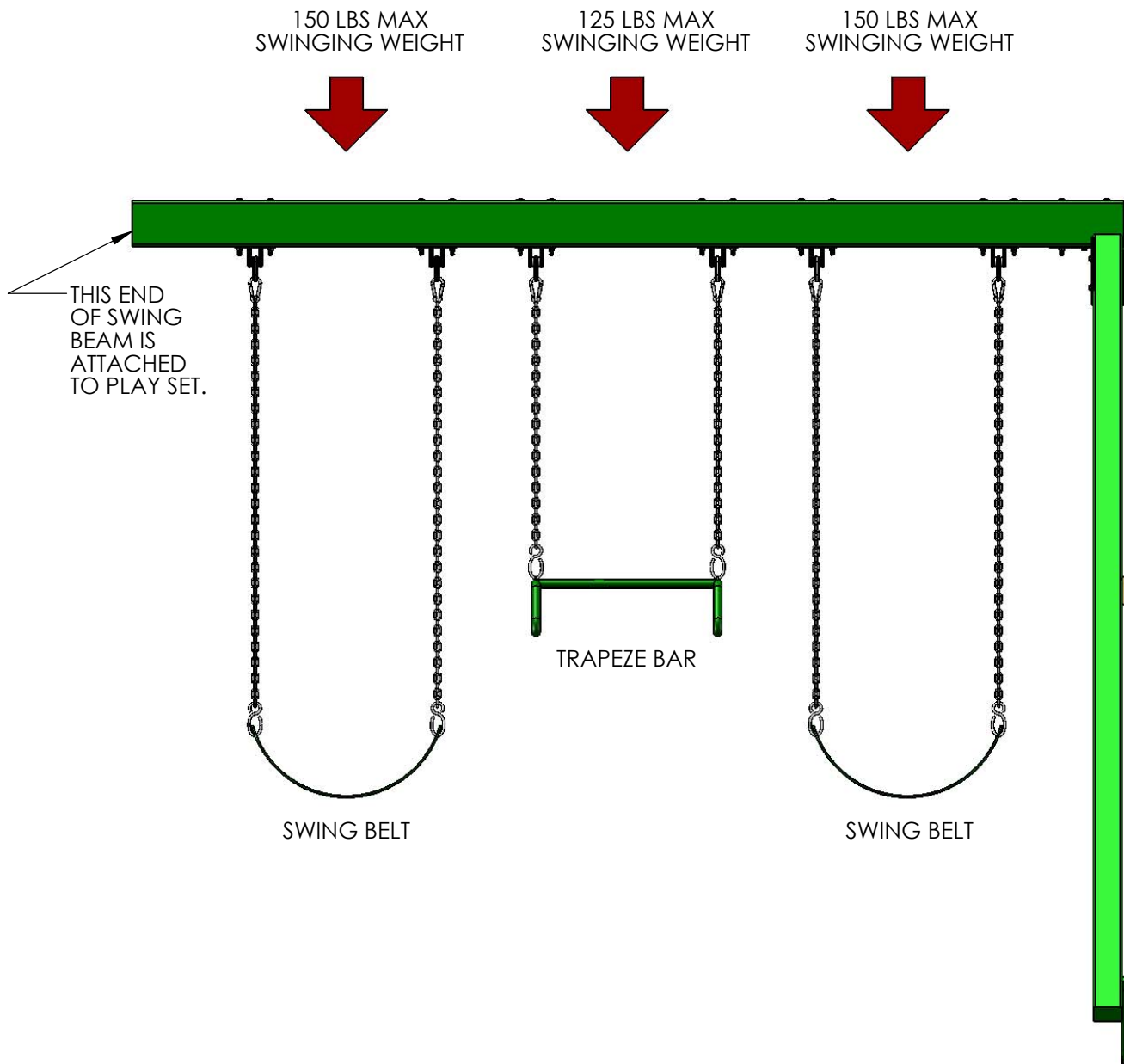

Please familiarize yourself with the manual, parts/components and general construction process of your new playset before getting started.

SITE PLAN:

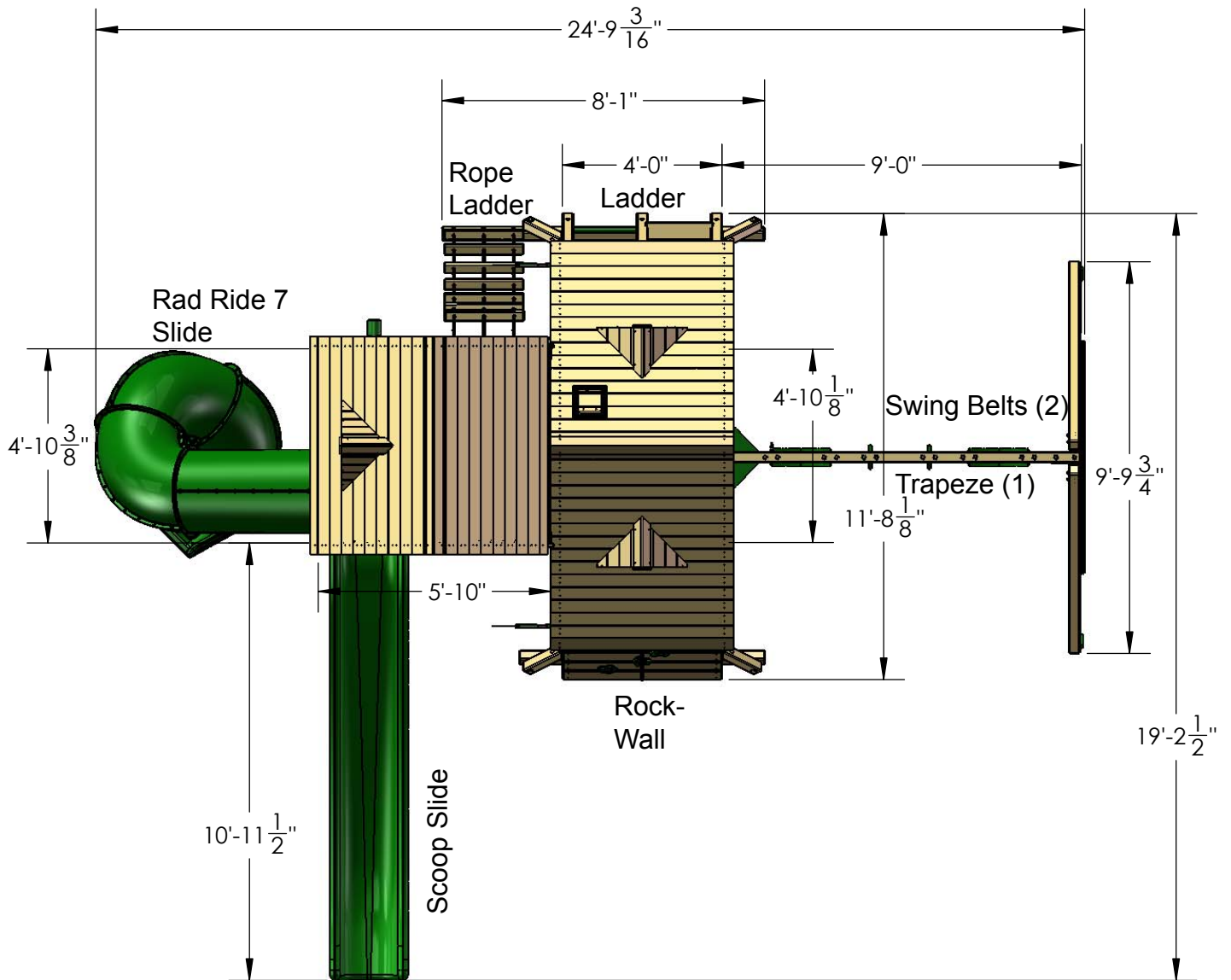

Playset height: 13'-4"

Deck heights: Lower Deck 5', Bridge Deck 7'-3-1/2", Upper Deck 7'

Approximate assembly time: 16 to 24 hours

(6) foot unobstructed safety perimeter around playset recommended

REQUIRED TOOL LIST:

- ___ Standard or Cordless Drill w/ Phillips Bit (#2 square bit provided)
- ___ Drill Bits 1/8", 3/8", 9/64", 11/64"
- ___ 1/2" Wrench and Socket
- ___ 1/2" Deep Well Socket
- ___ 9/16" Deep Well Socket
- ___ 9/16" Wrench and Socket
- ___ Level
- ___ Tape Measure
- ___ Extension Cord (if using standard drill)
- ___ Hammer
- ___ Pencil
- ___ Locking Pliers (Vise Grips)
- ___ Shovel

KIT CONTENTS

Swings, Slides, Accessories:

- ___ (Qty) Description
- ___ (2) Swingbelt w/ Chains
- ___ (1) Trapeze Swing w/ Chains
- ___ (10) Rock Wall Grips (assorted colors)
- ___ (1) Telescope
- ___ (1) Tire Swing w/ Chains
- ___ (1) Tic Tac Toe Panel
- ___ (1) Steering Wheel
- ___ (4) Safety Handles (Metal)
- ___ (1) Rad Ride 7 Slide
- ___ (1) Punching Bag
- ___ (1) Super Scoop Slide
- ___ (2) Safety Handles (Plastic - Pair)

Fort Hardware:

see following pages

Swing Beam Hardware:

see following pages

Wood Components:

see following pages

PART I
701-703 LOWER LEVEL

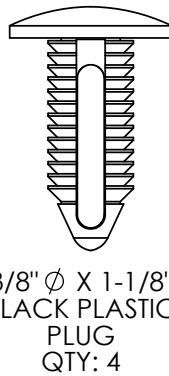
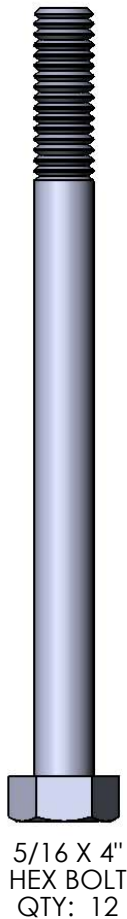
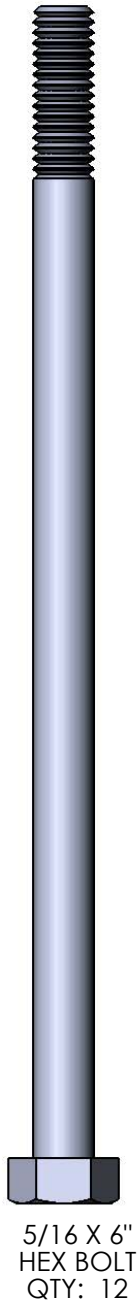
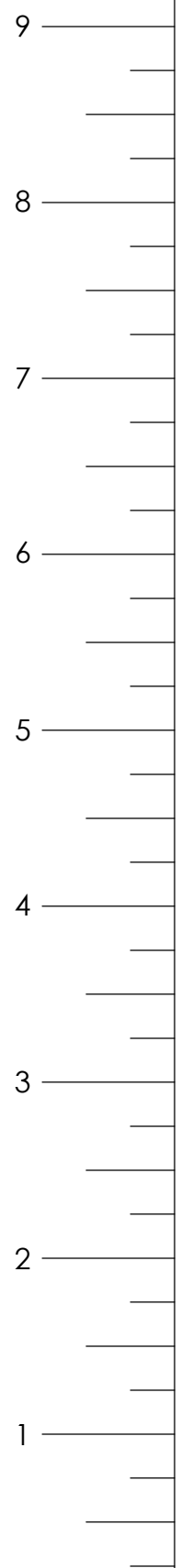
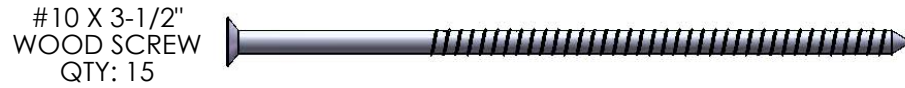
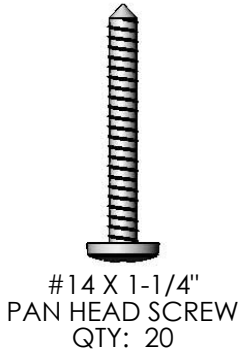

USE THE RULER TO THE RIGHT TO MEASURE YOUR BOLTS AND SCREWS. PICTURE VIEWS SHOWN ABOVE ARE 1:1 SCALE AND CAN BE USED TO MATCH BOLT AND SCREW SIZES.

11-0073
 701 Hardware
 REV C
 9/19/2014JH
 Page 2 of 2

3/8" X 3-1/2"
 HEX LAG SCREW
 QTY: 37

3/8" X 5"
 HEX LAG SCREW
 QTY: 14

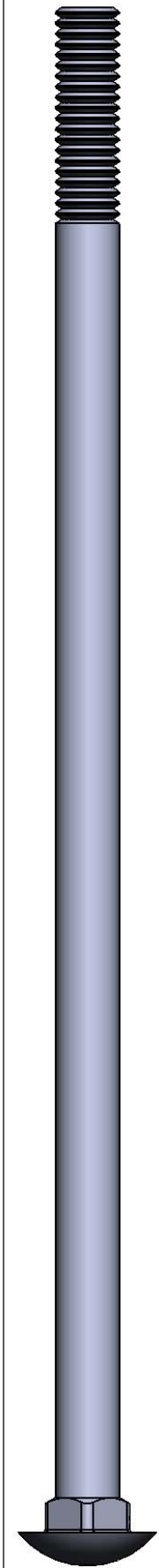

3/8 x 9"
 CARRIAGE BOLT
 QTY: 1

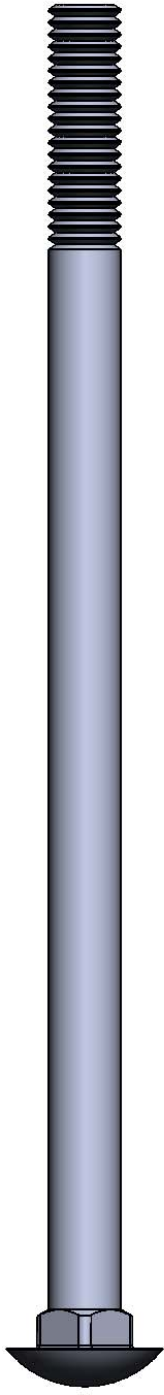

3/8" x 7"
 CARRIAGE BOLT
 QTY: 16

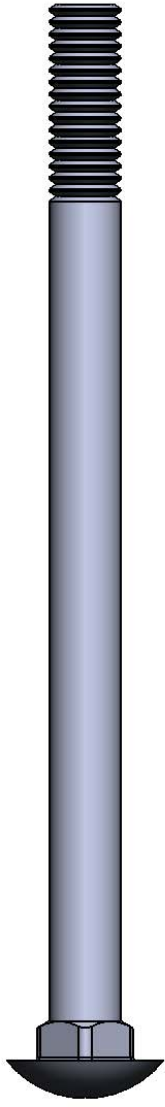

3/8" x 5-1/2"
 CARRIAGE BOLT
 QTY: 2

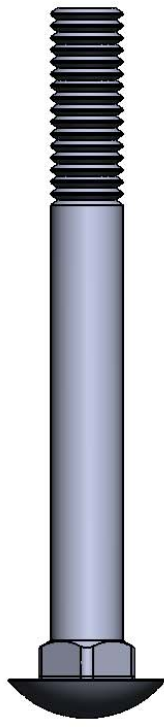

3/8" x 3-1/2"
 CARRIAGE BOLT
 QTY: 2

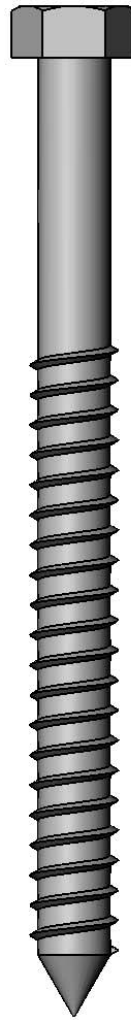
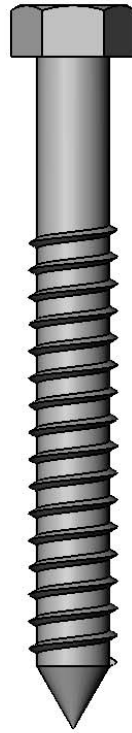

#2 SQUARE
 BIT
 QTY: 1



PLASTIC
 BOLT CAP
 QTY: 21



USE THE RULER TO THE RIGHT TO MEASURE YOUR BOLTS AND SCREWS. PICTURE VIEWS SHOWN ABOVE ARE 1:1 SCALE AND CAN BE USED TO MATCH BOLT AND SCREW SIZES.

11-0074
703N Hardware
REV C
9/19/2014 JH
Page 1 of 1

#8 x 1-1/4"
WOOD SCREW
QTY: 8



#8 x 1-1/2"
WOOD SCREW
QTY: 165



#8 X 2"
WOOD SCREW
QTY: 52

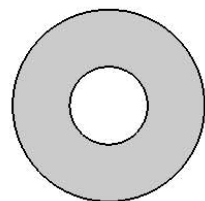

3/8" WASHER
QTY: 4



#2 SQUARE
DRIVE BIT
QTY: 1

3/8 X 3-1/2"
HEX LAG SCREW
QTY: 4

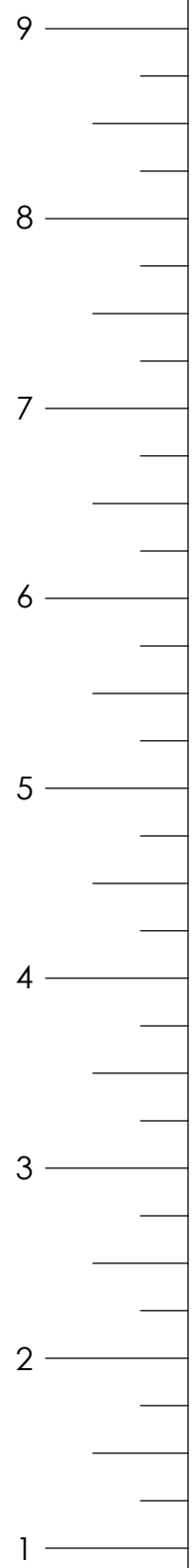
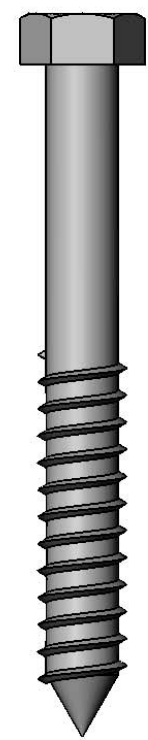



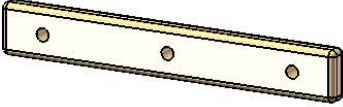
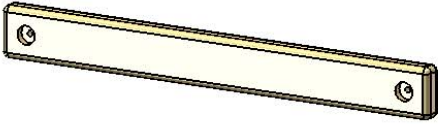
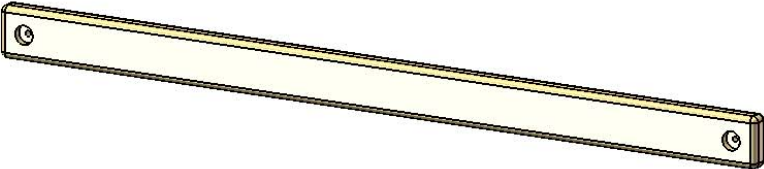
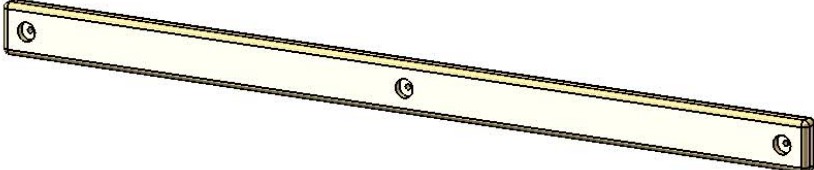
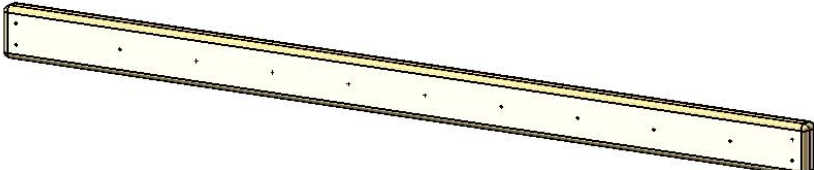
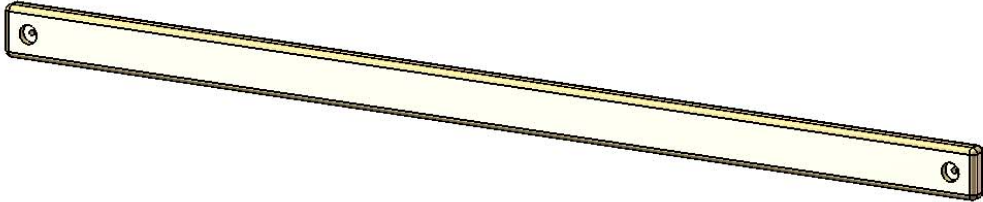
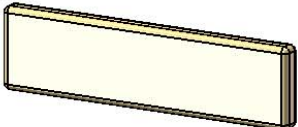

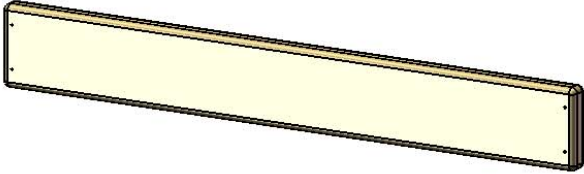
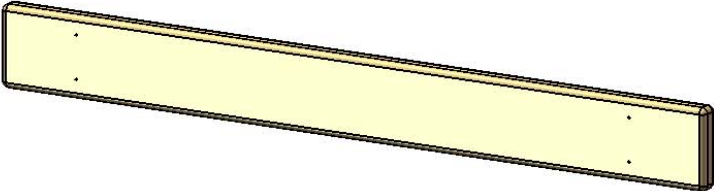
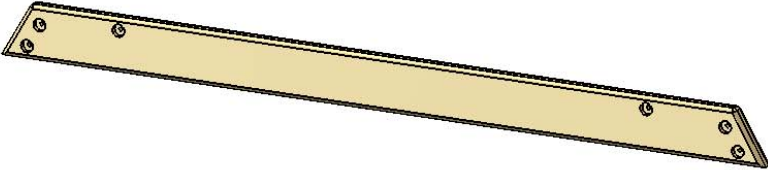
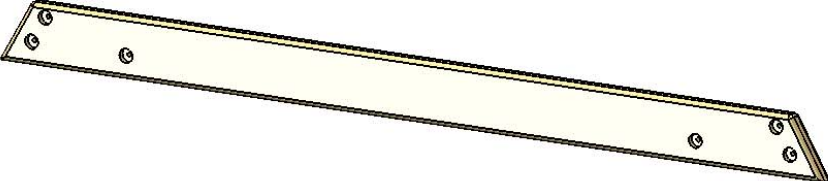
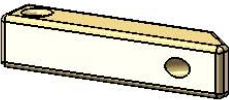
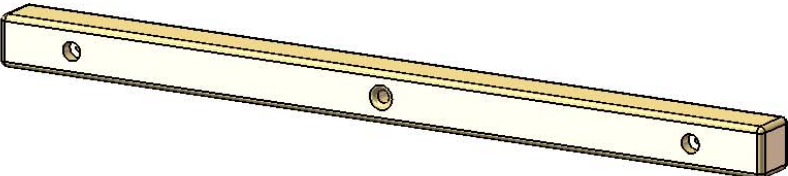
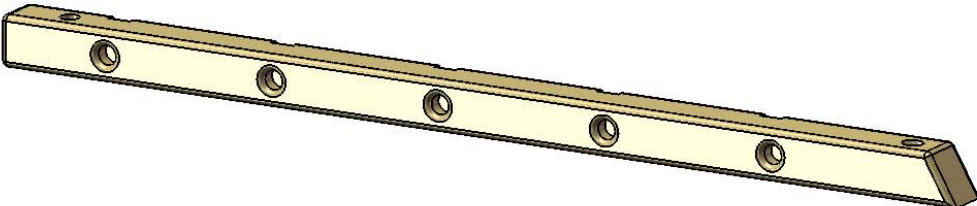

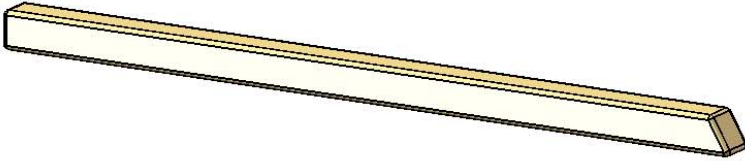
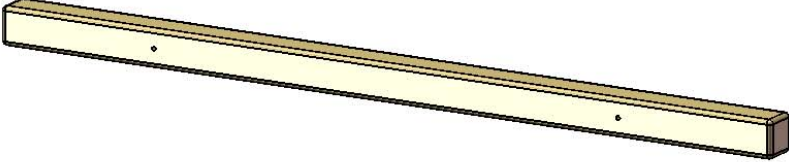
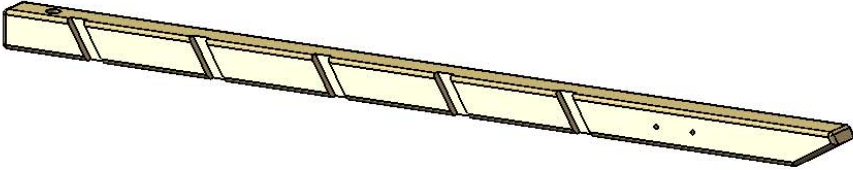
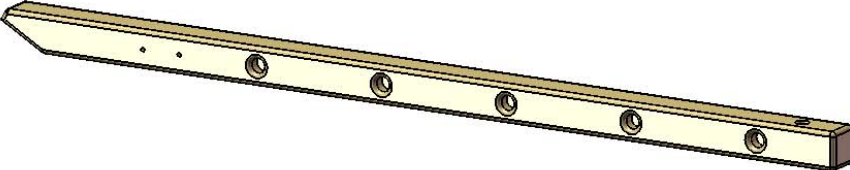
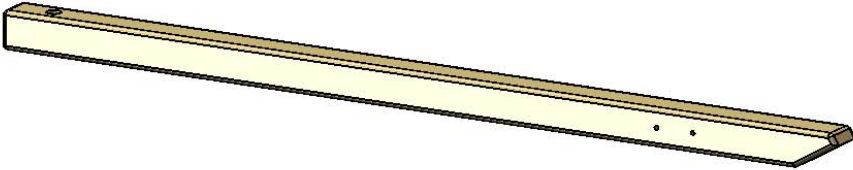
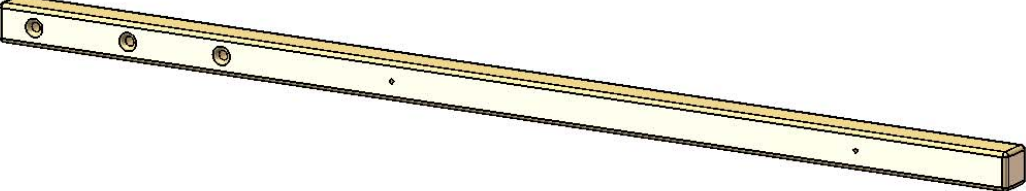
USE THE RULER TO THE RIGHT TO MEASURE YOUR BOLTS AND SCREWS. PICTURE VIEWS SHOWN ABOVE ARE 1:1 SCALE AND CAN BE USED TO MATCH BOLT AND SCREW SIZES.

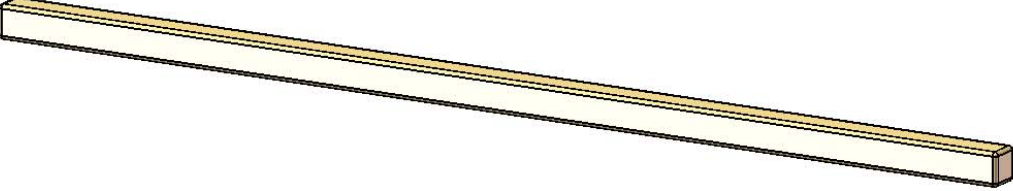
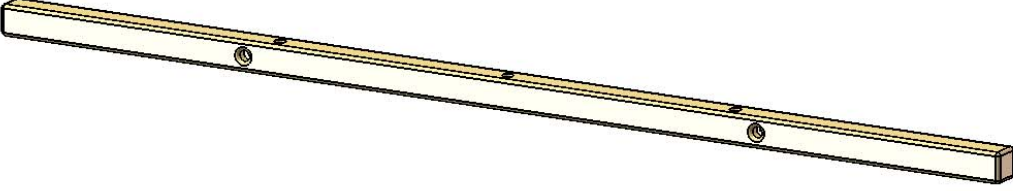
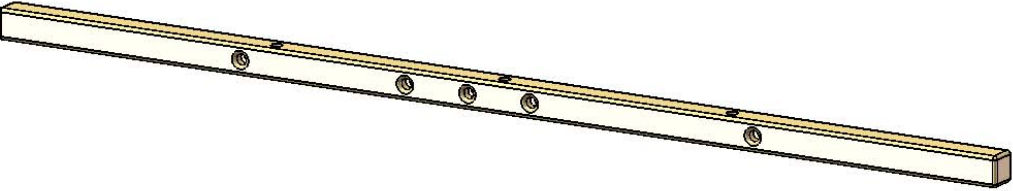
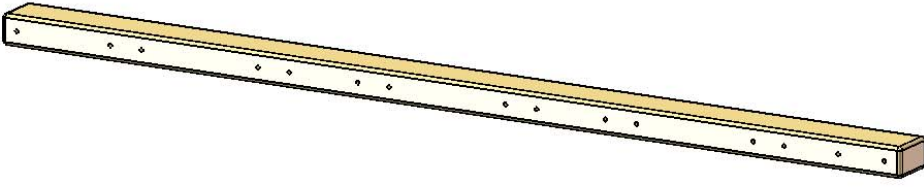
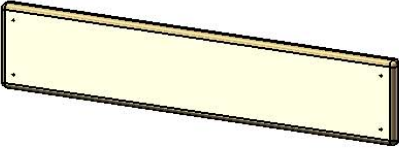
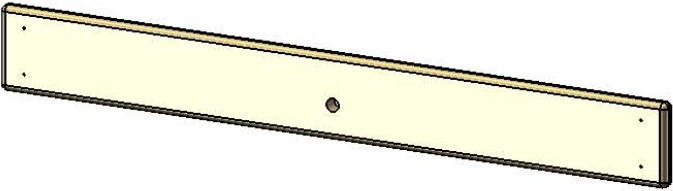
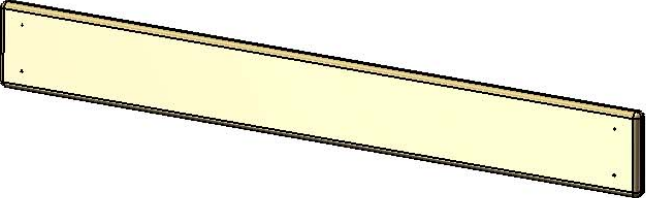

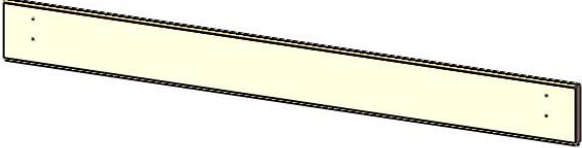

PICTURE	DESCRIPTION	QTY.
	2 X 2 X 10-5/8" TIC TAC TOE BOARD 2-2-1063-TTBT	2
	2 X 4 X 24" ROPE LADDER STEP 2-4-2400-RLST	7
 <div data-bbox="773 491 1024 590" style="border: 1px solid black; padding: 5px; display: inline-block; margin-left: 200px;"> <p>THIS ITEM WONT BE USED ON THIS PLAYSET</p> </div>	2 X 4 X 30-3/4" BOTTOM PANEL BOARD 2-4-3075-BPB	1
	2 X 4 X 54-1/2" TARP BOARD 2-4-5450-TB	2
	2 X 4 X 58" REAR BOTTOM PANEL BOARD 2-4-5800-RBPB	1
	2 X 4 X 58" ROCK WALL SUPPORT 2-4-5800-RWS	1
	2 X 4 X 70" SWING LEG CROSS MEMBER 2-4-7000-SLCM	1
	2 X 6 X 20-1/2" LADDER STEP 2-6-2050-LS	5

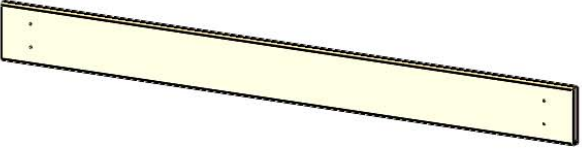

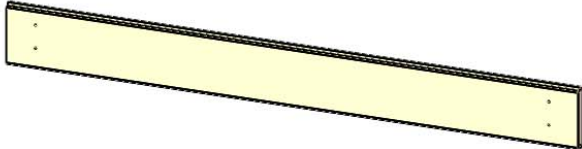
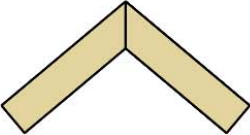
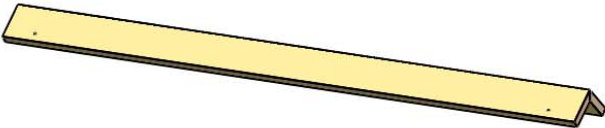
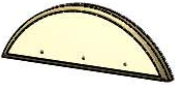
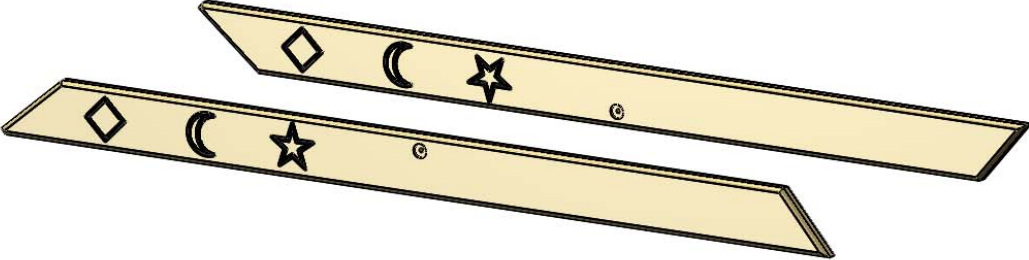
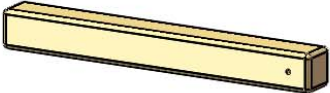
PICTURE	DESCRIPTION	QTY.
	2 X 6 X 41-1/4" DECK SPACER 2-6-4125-DS	4
	2 X 6 X 50-3/4" DECK BOARD 2-6-5075-DB	9
	2 X 6 X 78-3/4" INNER FORT SUPPORT 2-6-7875-IFS	2
	2 X 6 X 79-1/4" OUTER FORT SUPPORT 2-6-7925-OFS	2
	4 X 4 X 16" ANGLE SUPPORT (LEFT AND RIGHT) 4-4-1600-ASLS 4-4-1600-ASRS	2 LEFT 2 RIGHT
	4 X 4 X 55" ROCK WALL ROPE SUPPORT 4-4-5500-RWRS	1
	4 X 4 X 68-3/4" LADDER CENTER 4-4-6875-LC	1

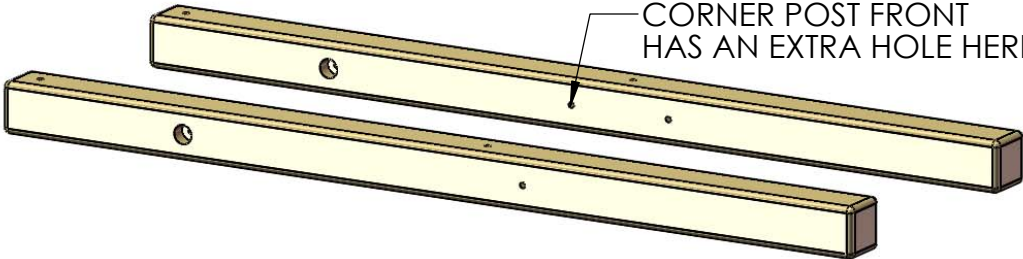
PICTURE	DESCRIPTION	QTY.
	4 X 4 X 70" TIRE SWING SUPPORT 4-4-7000-TSS	1
	4 X 4 X 74" ROCK WALL BOTTOM SUPPORT 4-4-7400-RWBS	1
	4 X 4 X 80-1/4" LADDER LEFT SIDE 4-4-8025-LLS	1
	4 X 4 X 80-1/4" LADDER RIGHT SIDE 4-4-8025-LRS	1
	4 X 4 X 80-1/4" ROCK WALL SIDE 4-4-8025-RWS	2
	4 X 4 X 88" ROPE LADDER SUPPORT 4-4-8800-RLS	1
	4 X 4 X 97" ROPE LADDER RUNNER 4-4-9700-RLR	1

PICTURE	DESCRIPTION	QTY.
	4 X 4 X 108" SWING LEG 4-4-10800-SL	2
	4 X 4 X 120" SIDE RAIL 4-4-12000-SR	1
	4 X 4 X 120" SWING BEAM SIDE RAIL 4-4-12000-SBSR	1
	4 X 6 X 108" SWING BEAM 4-6-10800-SB	1
 <div data-bbox="781 1360 1032 1461" style="border: 1px solid black; padding: 2px; display: inline-block;"> ONLY 6 ITEMS WILL BE USED ON THIS PLAYSET </div>	5/4 X 4 X 28-1/2" PANEL SLAT 125-4-2850-PS	9
	5/4 X 6 X 48" BOTTOM ROCK WALL BOARD 125-6-4800-BRWB	1
	5/4 X 6 X 48" ROCK WALL BOARD 125-6-4800-RWB	11

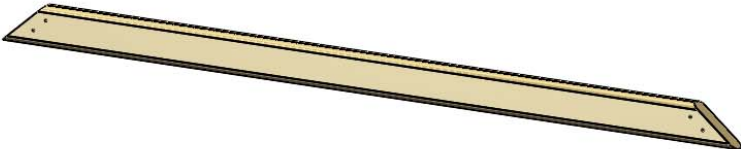
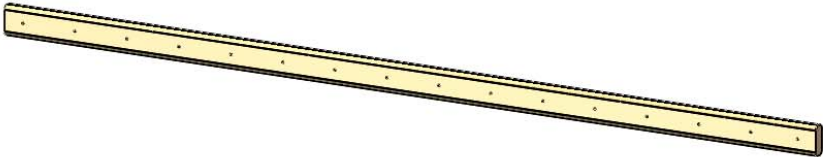
	PICTURE	DESCRIPTION	QTY.
		1 X 5 X 55" ROOF FINISHER 1-5-5500-RF	2
		1 X 5 X 55" ROOF STARTER 1-5-5500-RS	2
		1 X 6 X 55" ROOF BOARD 1-6-5500-RB	28
		1 X 6 X 55" ROOF PEAK 1-6-5500-RP	1
		2 X 6 X 16" SUN 2-6-1600-S	2
		2 X 6 X 80-1/4" ROOF SUPPORT LEFT AND RIGHT 2-6-8025-RSL 2-6-8025-RSR	2 LEFT 2 RIGHT
		4 X 4 X 29-1/2" CENTER POST 4-4-2950-CP	2

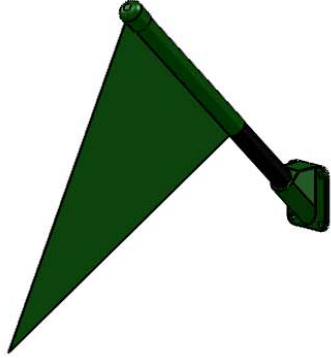
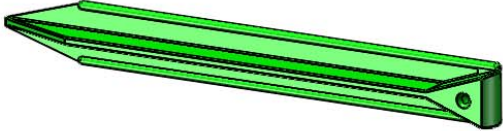
PICTURE	DESCRIPTION	QTY.
	<p>4 X 4 X 61-1/4" CORNER POST FRONT/REAR</p> <p>4-4-6125-CPF</p> <p>4-4-6125-CPR</p>	<p>2</p> <p>2</p>
	<p>5/4 X 6 X 12" ROOF TRIANGLE</p> <p>125-6-1200-RT</p>	<p>2</p>
	<p>5/4 X 2 X 13" SMALL RAY</p> <p>125-2-1300-SR</p>	<p>4</p>
	<p>5/4 X 2 X 14" MEDIUM RAY</p> <p>125-2-1400-MR</p>	<p>4</p>
	<p>5/4 X 2 X 17" LARGE RAY</p> <p>125-2-1700-LR</p>	<p>2</p>
	<p>5/4 X 3 X 53" SUN SUPPORT</p> <p>125-3-5300-SS</p>	<p>2</p>
	<p>5/4 X 3 X 78" ROOF SUPPORT</p> <p>125-3-7800-RS</p>	<p>2</p>

PICTURE	DESCRIPTION	QTY.
	<p>FLAG KIT 09-1014</p>	<p>2</p>
	<p>GROUND STAKES (PAIR) 07-0016-P</p>	<p>1 pr</p>
	<p>TRAPEZE BAR W/CHAINS 04-0006</p>	<p>1</p>
	<p>SWING W/CHAINS 04-0002</p>	<p>2</p>

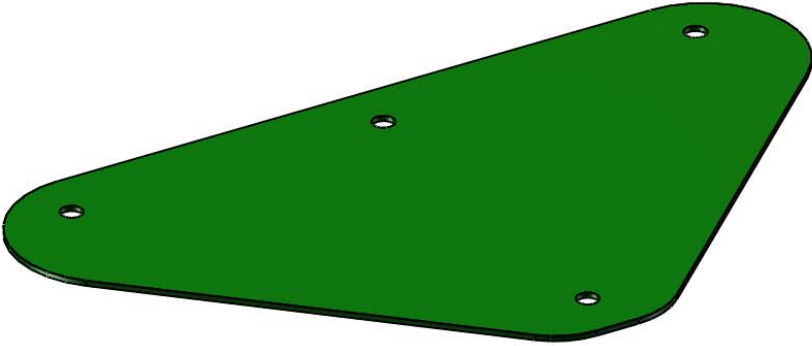
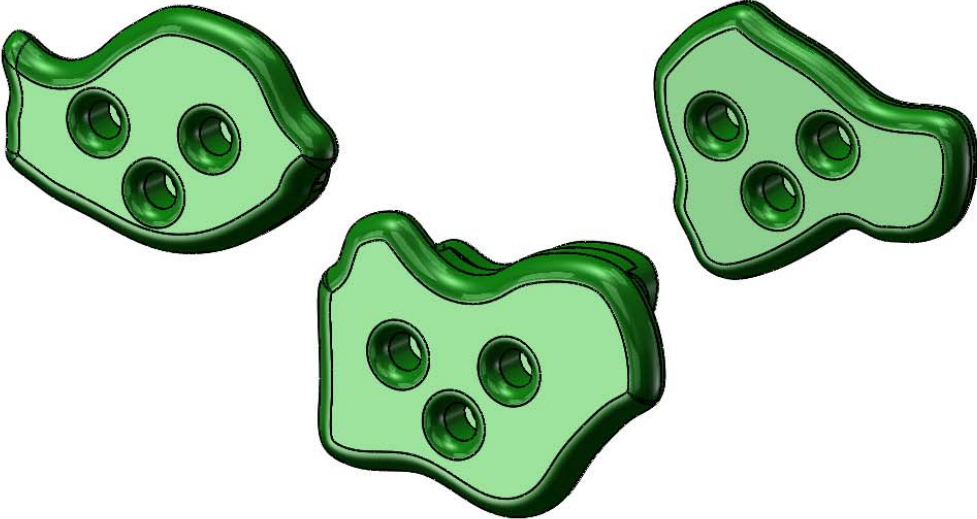
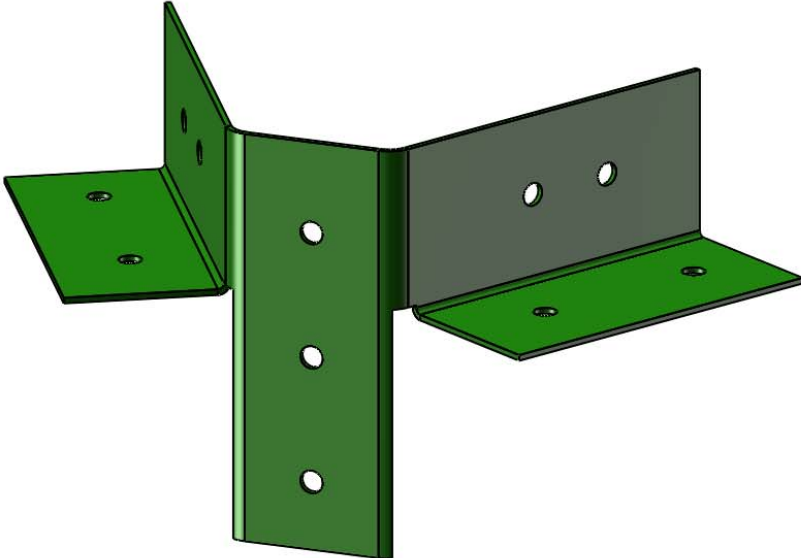
PICTURE	DESCRIPTION	QTY.
	<p>SWING PLATE 11-5002</p>	<p>1</p>
	<p>CLIMBING ROCKS (07-0008 is a pkg of 5)</p>	<p>10 ROCKS</p>
	<p>A-FRAME SWING LEG BRACKET 11-5010</p>	<p>1</p>
<p>701N & 703N HARDWARE BOXES</p>	<p>HARDWARE BOXES 11-0073 11-0074</p>	<p>1 EA 28</p>

PICTURE

DESCRIPTION

QTY.

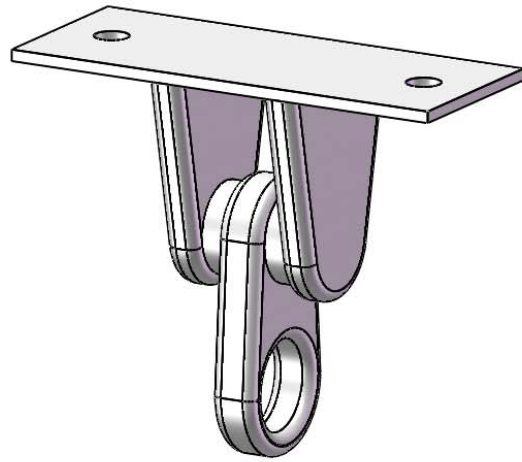

IRON
DUCTILE
SWING
HANGER

11-4012

6

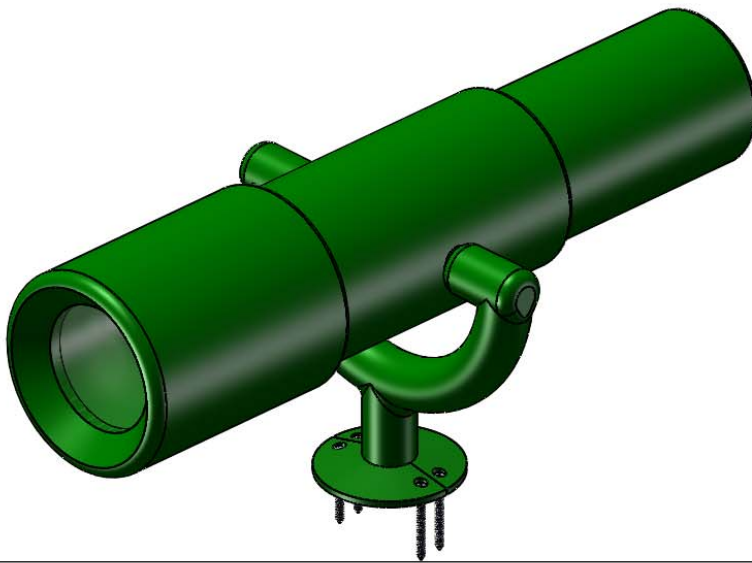

TELESCOPE

07-0001

1

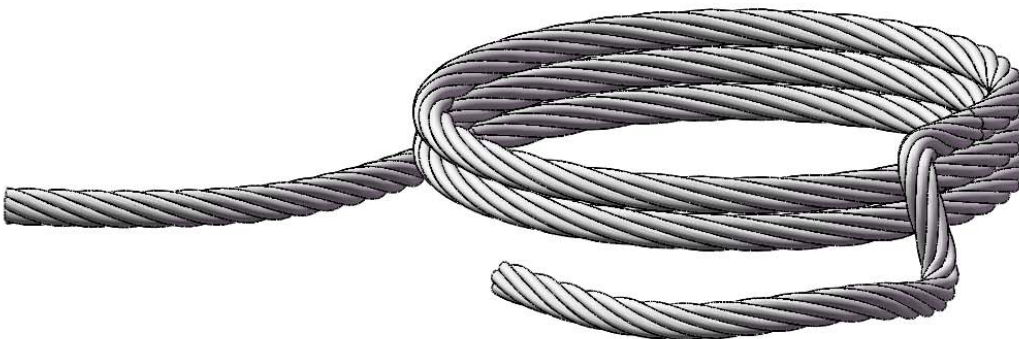





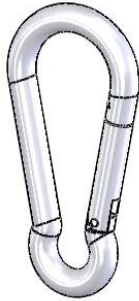

10' ROPE

15'
ROPE
LADDER
ROPES

1

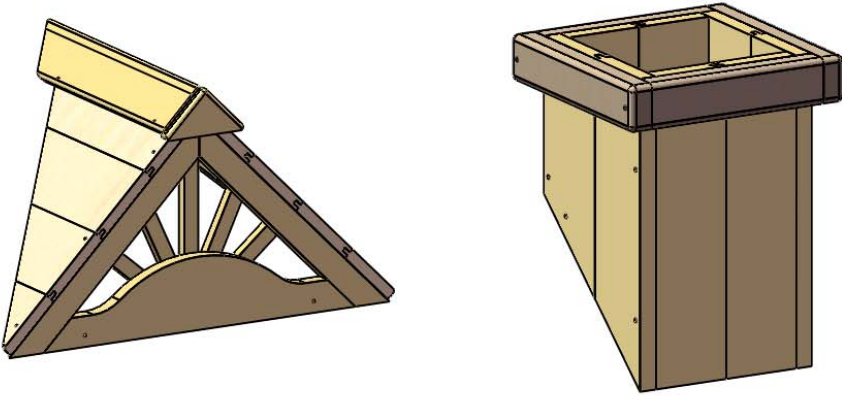
3

PICTURE	DESCRIPTION	QTY.
	<p>TIRE SWING 04-0014</p>	<p>1</p>
	<p>SPRING CLIP 11-4003</p>	<p>9</p>
	<p>TIRE SWIVEL 11-4010</p>	<p>1</p>
	<p>TIC TAC TOE PANEL 07-0010</p>	<p>1</p>

PICTURE	DESCRIPTION	QTY.
	<p>UNASSEMBLED DORMER</p> <p>UNASSEMBLED CHIMNEY</p> <p>01-3005 (705 BOX)</p>	<p>2</p> <p>1</p>
	<p>STEERING WHEEL</p> <p>07-0004</p>	<p>1</p>
	<p>LADDER RUNG</p> <p>1-5/16" X 21-1/2"</p> <p>11-5106</p>	<p>5</p>
	<p>SAFETY HANDLE</p> <p>08-0001</p>	<p>4</p>

STEP 1: ASSEMBLING THE LADDER

1: START WITH THE 4 X 4 X 80-1/4" LADDER SIDES. THE SIDES SHOULD BE POSITIONED IN A MANNER THAT ALLOWS THE FIVE HOLES AND THE FIVE CHANNELS ON THE INSIDE TO FACE EACH OTHER, AND THE ANGLED ENDS SHOULD BE FACING THE SAME WAY. IT SHOULD ALSO BE NOTED THAT THERE ARE TWO 3/8" HOLES JUST ABOVE THE FIVE LADDER RUNG HOLES AND CHANNELS.

2: LAY THE LEFT LADDER SIDE ON THE GROUND AND PLACE THE FIVE 2 X 6 X 20-1/2" LADDER STEPS INSIDE THE CHANNELS. ATTACH WITH 2-1/2" WOOD SCREWS. LEAVE THE LADDER SIDE ON THE GROUND WITH THE LADDER STEPS STICKING UP. YOU MAY HAVE TO USE A RUBBER Mallet TO INSERT STEPS.

3: THE CHANNELS ON THE 4 X 4 X 68-3/4" LADDER CENTER WILL MATCH UP WITH THE LADDER STEPS INSTALLED IN THE PREVIOUS STEP. ATTACH THE LADDER CENTER TO THE LADDER STEPS USING A 2-1/2" WOOD SCREW IN EACH BOARD, STARTING THE SCREW FROM INSIDE EACH COUNTERBORE (THE HOLES WHERE THE METAL RUNGS WILL BE INSTALLED) IN THE LADDER CENTER.

4: THE METAL RUNGS WILL INSTALL IN THE COUNTERBORES OF THE LADDER CENTER. YOU MAY NEED TO USE A RUBBER Mallet TO INSERT THE RUNGS

5: TAKE THE OTHER LADDER SIDE BOARD AND LINE UP THE LADDER RUNG HOLES WITH THE METAL LADDER RUNGS PREVIOUSLY INSTALLED. IF THE RUNGS CAN SPIN, USE 2-1/2" WOOD SCREWS TO SECURE. DRIVE THE SCREWS INTO THE LADDER SIDES AT AN ANGLE, FROM THE BACK SIDE. NOTE: DO NOT COMPLETE THIS STEP UNTIL ENTIRE FORT IS ASSEMBLED.

6: INSTALL T-NUTS INTO THE HOLES JUST ABOVE THE LADDER RUNGS AND STEPS. THE HOLE CLOSEST TO THE RUNGS WILL GET A T-NUT ON THE OUTSIDE, AND THE HOLE JUST ABOVE IT WILL GET A T-NUT ON THE INSIDE.

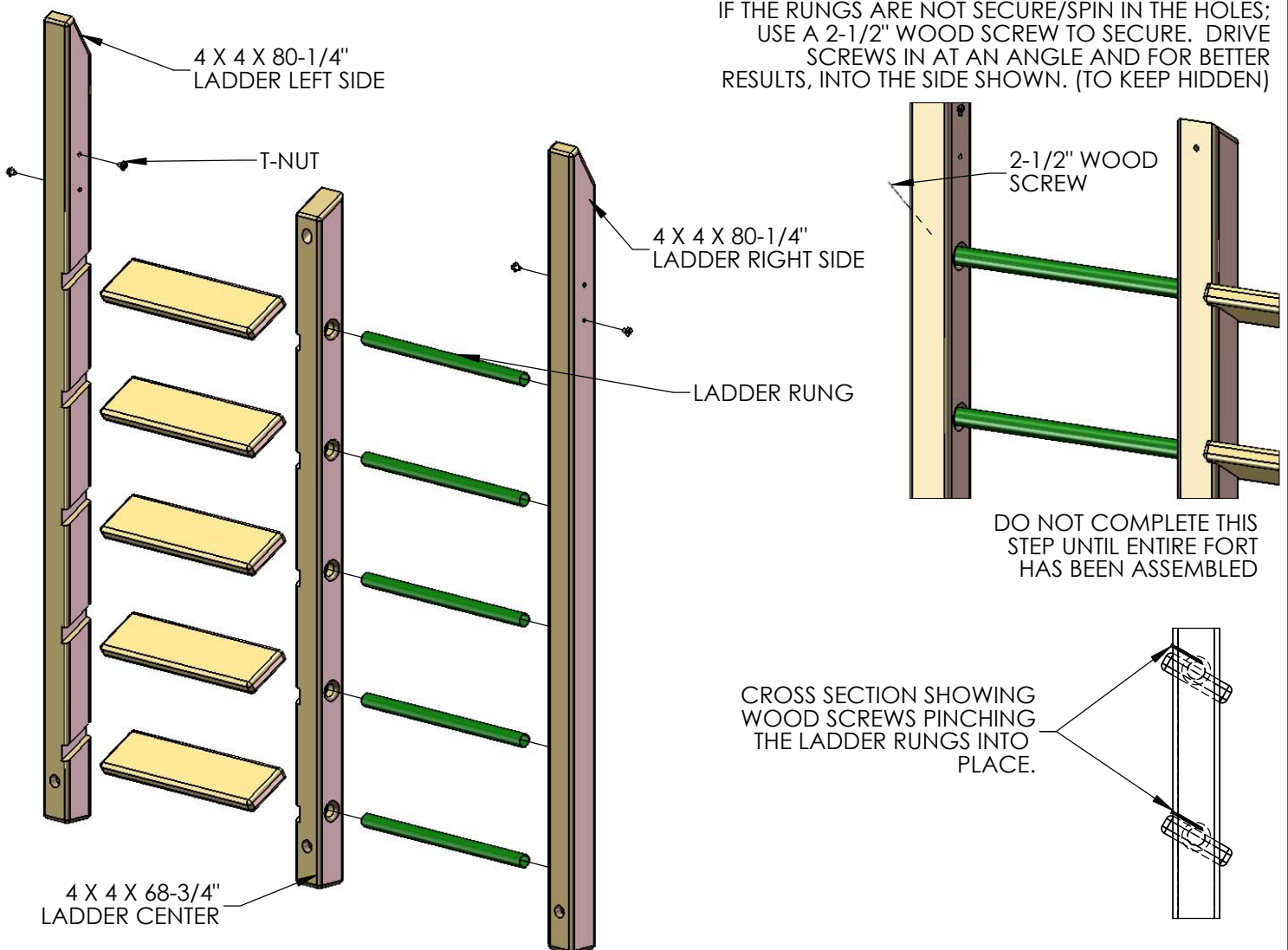

STEP 2: ATTACHING THE ROPE LADDER RUNNER

1: FIND THE 4 X 4 X 97" ROPE LADDER RUNNER. TAKE SPECIAL NOTE OF THE ROUNDED EDGE ON THE 7/8" HOLES ON THE END OF THE ROPE LADDER RUNNER.

2: LINE UP THE TWO 3/8" PILOT HOLES ON THE ROPE LADDER RUNNER TO THE COUNTER-SUNK HOLES ON THE LADDER SIDE PIECES. THE COUNTERSUNK HOLES OF THE LADDER ASSEMBLY WILL FACE OUTWARDS.

3: FIND TWO T-NUTS, AND SET WITH A HAMMER ON THE EXPOSED 3/8" HOLES OF THE ROPE LADDER RUNNER.

4: FASTEN THE ROPE LADDER RUNNER TO THE LADDER ASSEMBLY WITH 5/16 X 6" HEX BOLTS AND 5/16" WASHERS THROUGH THE COUNTER-SUNK HOLES OF THE LADDER SIDES AND INTO THE T-NUTS INSTALLED IN THE ROPE LADDER RUNNER. ATTACH THE LADDER CENTER TO THE ROPE LADDER RUNNER USING ONE 3/8" X 5" LAG SCREW AND ONE 3/8" WASHER.

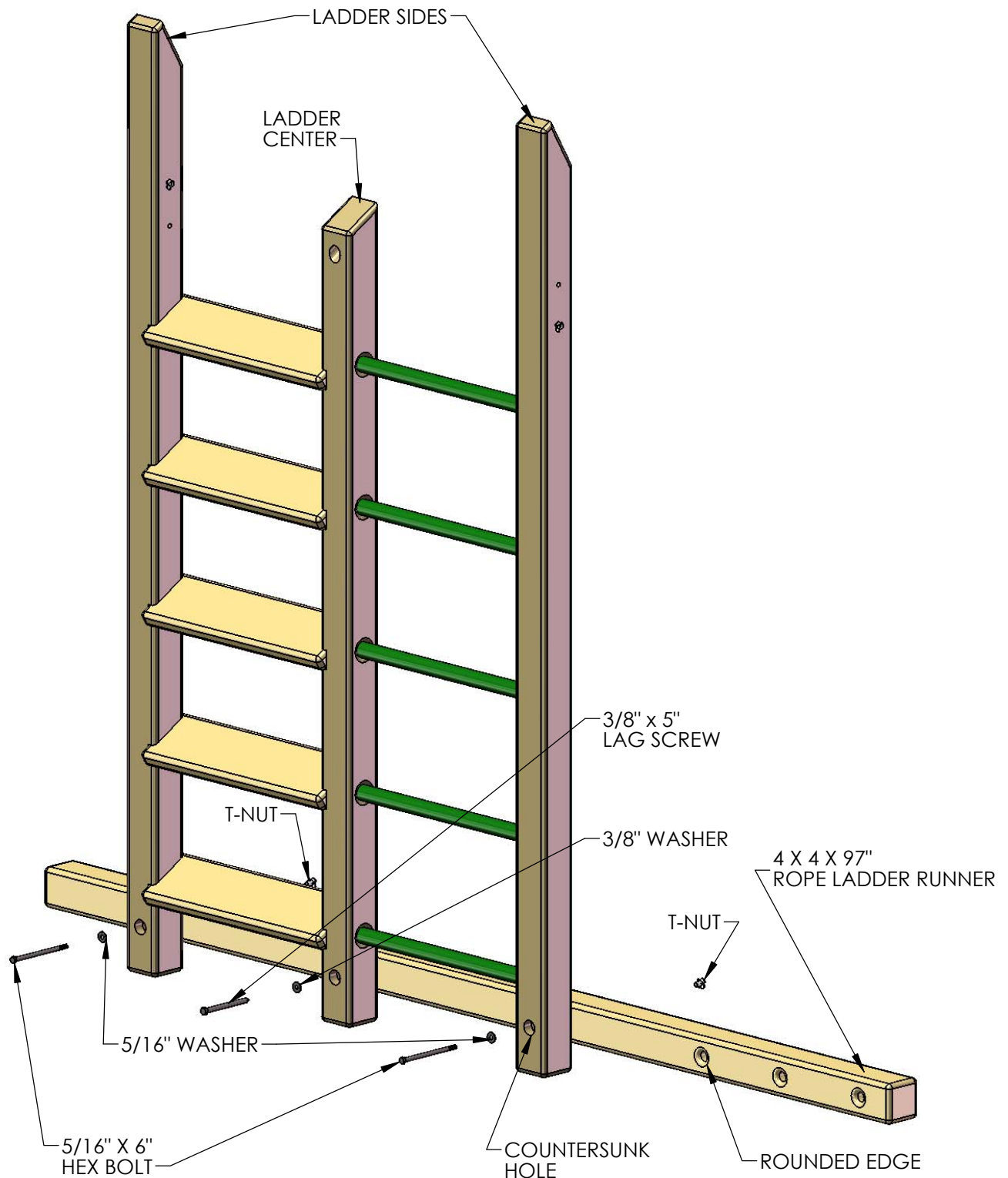

STEP 3: INSTALLING ANGLE SUPPORTS

- 1: MAKE SURE THE LADDER ASSEMBLY IS SQUARE. FIND TWO 4 X 4 X 16" ANGLE SUPPORTS.
- 2: PLACE THE ANGLE SUPPORTS ON THE LADDER ASSEMBLY SO THAT THE ANGLED END RESTS AGAINST THE LADDER SIDES, AND THE COUNTER-SUNK HOLE ON THE FLAT END FACES OUT. CENTER THE COUNTER-SUNK HOLES ON THEIR RESPECTIVE BOARDS BEFORE ATTACHING.
- 3: FASTEN THE ANGLED END TO THE LADDER SIDE WITH ONE 3/8 X 3-1/2" LAG SCREW WITH A 3/8" WASHER.
- 4: FASTEN THE FLAT END TO THE ROPE LADDER RUNNER WITH ONE 3/8 X 5" LAG SCREW WITH A 3/8" WASHER.
- 5: REPEAT STEPS 2-4 TO FASTEN THE ANGLE SUPPORT TO THE OPPOSITE SIDE OF THE LADDER ASSEMBLY.

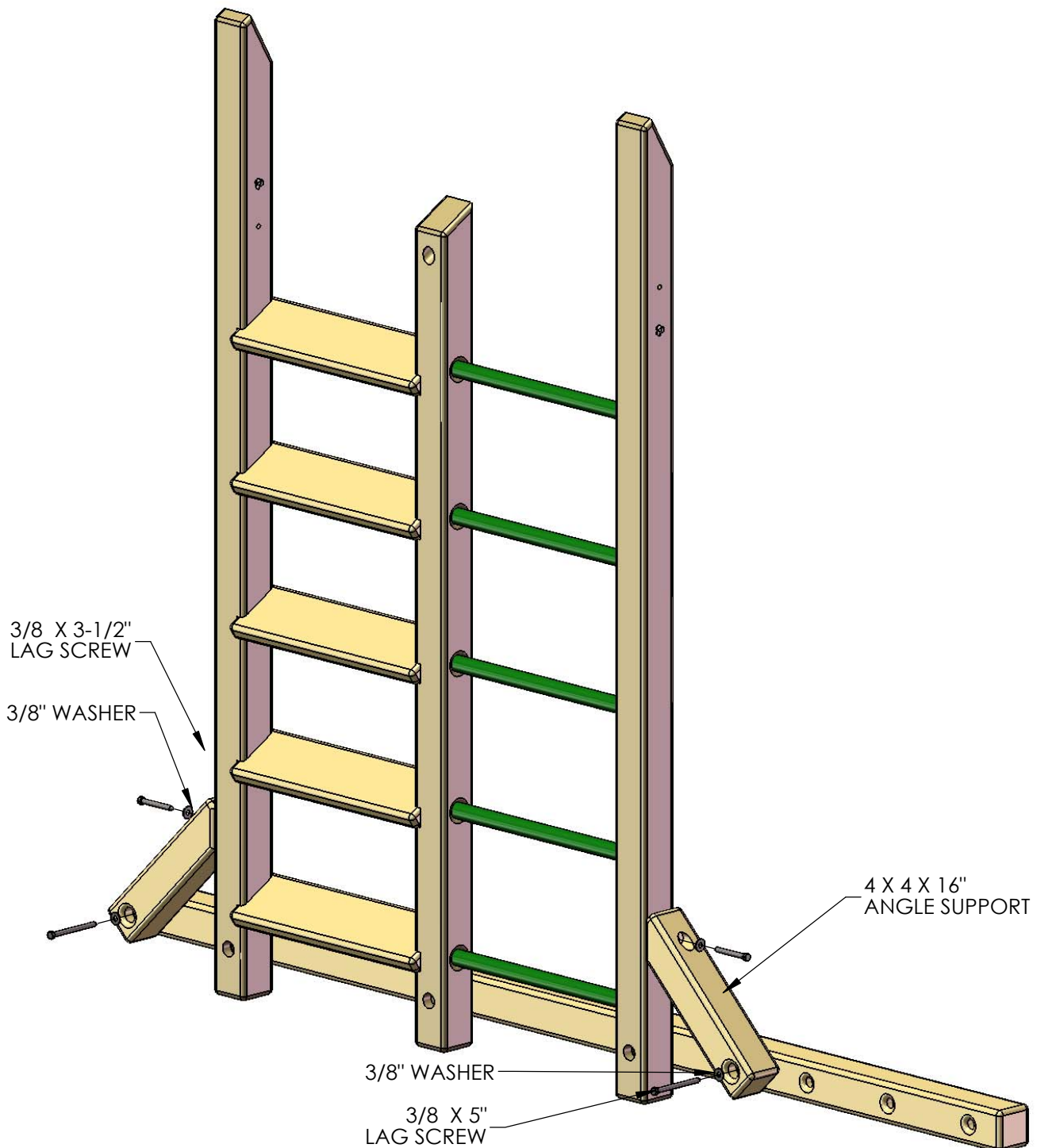

STEP 4: ASSEMBLING THE ROCK WALL

1: START WITH THE 4 X 4 X 80-1/4" ROCK WALL SIDES. THE SIDES SHOULD BE POSITIONED IN A MANNER THAT ALLOWS THE ANGLED ENDS TO FACE THE SAME WAY. IT SHOULD ALSO BE NOTED THAT THERE ARE TWO 3/8" HOLES JUST BELOW THE ANGLED ENDS.

2: INSTALL T-NUTS INTO THE HOLES JUST BELOW THE ANGLED ENDS. THE BOTTOM HOLES WILL GET A T-NUT ON THE OUTSIDE, AND THE TOP HOLES WILL GET A T-NUT ON THE INSIDE.

3: FIND THE 4 X 4 X 74" ROCK WALL BOTTOM SUPPORT. LINE UP THE 3/8" PILOT HOLES ON THE ROCK WALL BOTTOM SUPPORT TO THE COUNTER-SUNK HOLES ON THE ROCK WALL SIDES.

4: FIND TWO T-NUTS, AND SET WITH A HAMMER ON THE EXPOSED 3/8" HOLES OF THE ROCK WALL BOTTOM SUPPORT.

5: FASTEN THE ROCK WALL BOTTOM SUPPORT TO THE ROCK WALL SIDES WITH 5/16 X 6" HEX BOLTS AND 5/16" WASHERS THROUGH THE COUNTER-SUNK HOLES OF THE ROCK WALL SIDES AND INTO THE T-NUTS INSTALLED IN THE ROCK WALL BOTTOM SUPPORT.

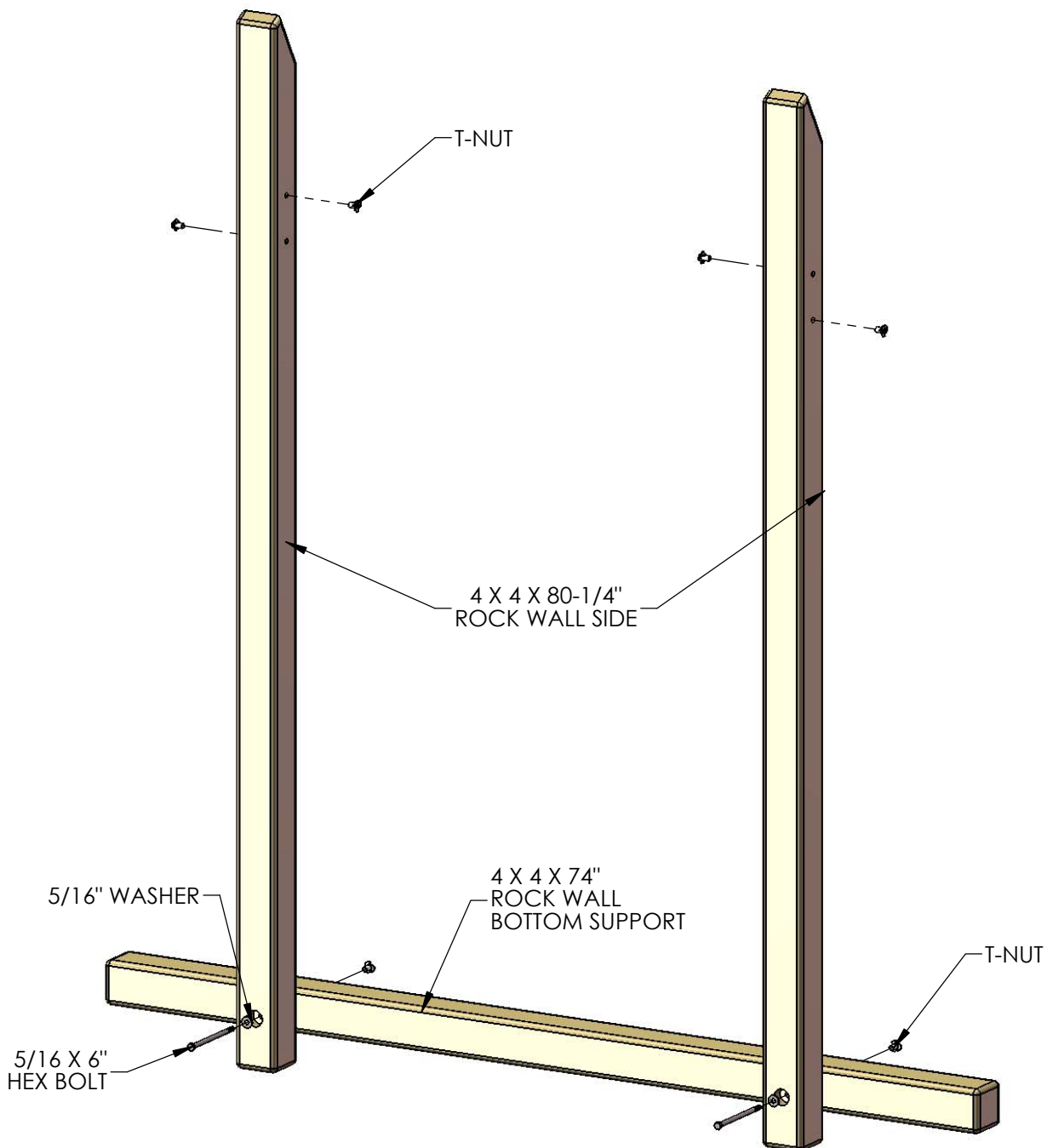

STEP 5: ASSEMBLING THE ROCK WALL

1: MEASURE 67" FROM THE BOTTOM OF EACH OF THE ROCK WALL SIDES AND MARK THIS LOCATION.

2: BEFORE INSTALLING BOARDS, MAKE SURE THAT THE ROCK WALL SIDES ARE SQUARE TO THE ROCK WALL BOTTOM SUPPORT. ONCE THE ROCK WALL SIDES ARE SQUARE, LAY THE 5/4 X 6 X 48" ROCK WALL BOARD ON THE ROCK WALL SIDES WITH THE TOP OF THE BOARD PLACED AT THE 67" MARK PREVIOUSLY MADE. ATTACH WITH TWO 2" WOOD SCREWS PER SIDE.

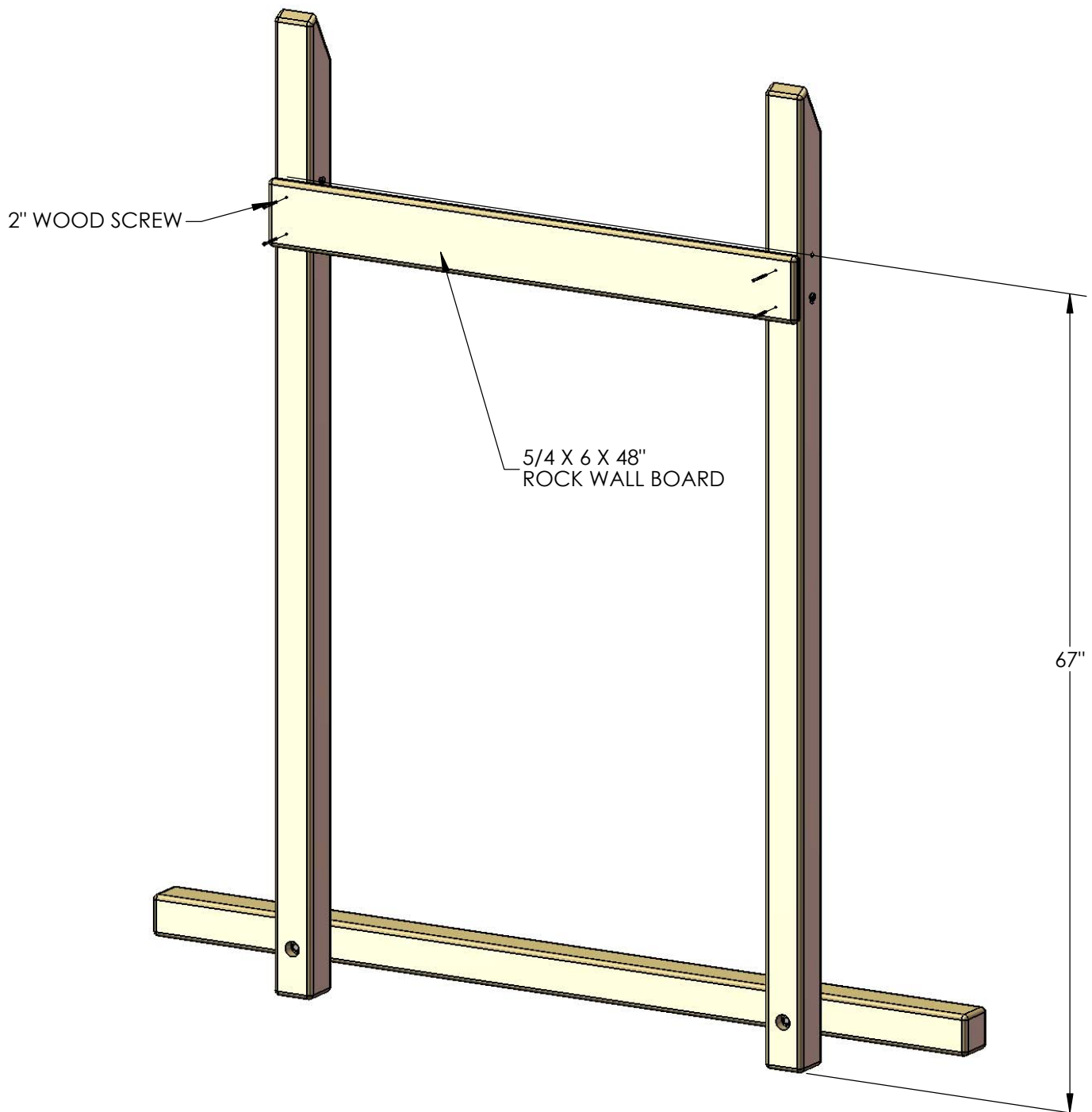

STEP 6: INSTALLING ANGLE SUPPORTS

- 1: MAKE SURE THE ROCK WALL ASSEMBLY IS SQUARE. FIND TWO 4 X 4 X 16" ANGLE SUPPORTS.
- 2: PLACE THE ANGLE SUPPORTS ON THE ROCK WALL ASSEMBLY SO THAT THE ANGLED END RESTS AGAINST THE ROCK WALL SIDES, AND THE COUNTER-SUNK HOLE ON THE FLAT END FACES OUT. CENTER THE COUNTER-SUNK HOLES ON THEIR RESPECTIVE BOARDS BEFORE ATTACHING.
- 3: FASTEN THE ANGLED END TO THE ROCK WALL SIDE WITH ONE 3/8 X 3-1/2" LAG SCREW WITH A 3/8" WASHER.
- 4: FASTEN THE FLAT END TO THE ROCK WALL BOTTOM SUPPORT WITH ONE 3/8 X 5" LAG SCREW WITH A 3/8" WASHER.
- 5: REPEAT STEPS 2-4 TO FASTEN THE ANGLE SUPPORT TO THE OPPOSITE SIDE OF THE ROCK WALL ASSEMBLY.

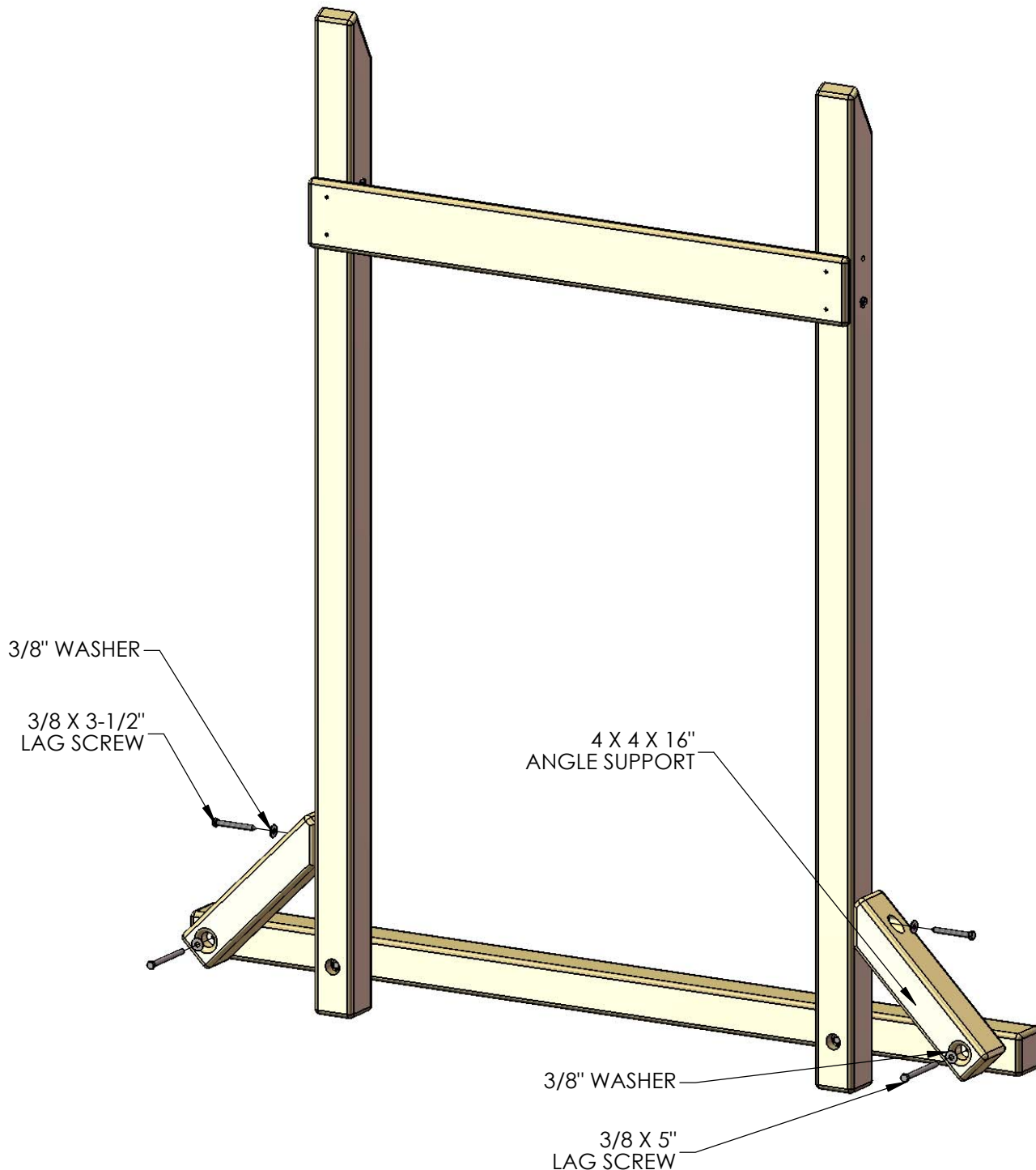

STEP 7: INSTALLING OUTER FORT SUPPORTS

1: FIND THE TWO 2 X 6 X 79-1/4" OUTER FORT SUPPORTS. THE EASIEST WAY TO DIFFERENTIATE THE OUTER SUPPORTS FROM THE INNER SUPPORTS IS TO LOOK FOR THE COUNTER-SUNK HOLES AT 12-1/4" FROM EACH END. THE TWO BOARDS WITH THE HOLES CLOSEST TO THE BOTTOM (LONGER) SIDE ARE THE OUTER FORT SUPPORTS, THE BOARDS WITH THE HOLES CLOSEST TO THE TOP (SHORTER) SIDE ARE THE INNER FORT SUPPORTS.

2: LAY THE LADDER ASSEMBLY AND ROCK WALL ASSEMBLY FLAT ON THE GROUND, AND LINE UP THE 3/8" HOLE CLOSEST TO THE TOP WITH THE TOP HOLE OF THE OUTER FORT SUPPORT.

3: ATTACH THE OUTER FORT SUPPORT TO THE LADDER AND ROCK WALL ASSEMBLY WITH 5/16 X 4" HEX BOLTS AND 5/16" WASHERS.

4: REPEAT STEPS 2 AND 3 TO FASTEN THE OUTER FORT SUPPORT TO THE OPPOSITE SIDE OF THE FORT.

5: WITH HELP, LIFT UP THE LADDER ASSEMBLY AND ROCK WALL ASSEMBLY SO THAT THE LADDER SIDES AND ROCK WALL SIDES ARE FLUSH TO THE ANGLED SIDES OF THE OUTER FORT SUPPORT.

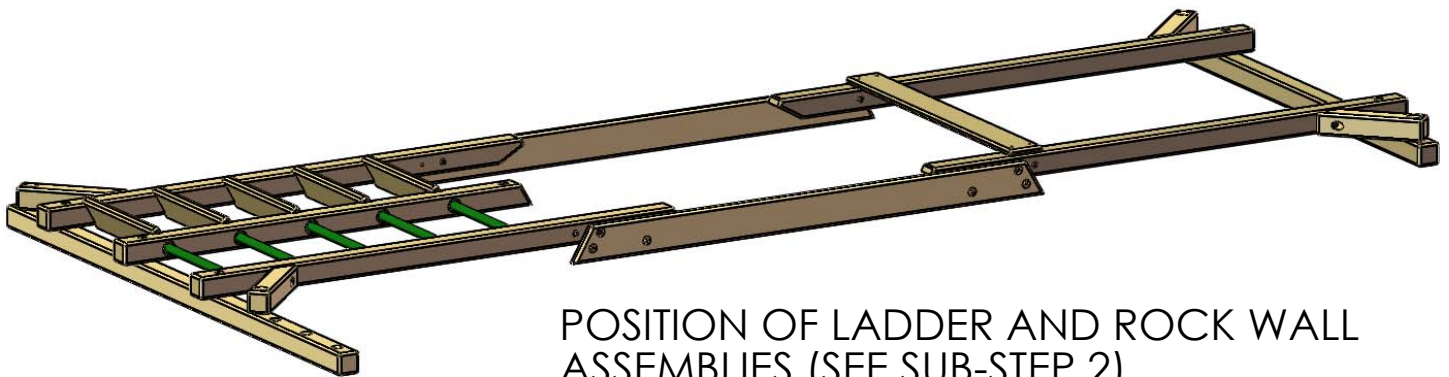

POSITION OF LADDER AND ROCK WALL ASSEMBLIES (SEE SUB-STEP 2)

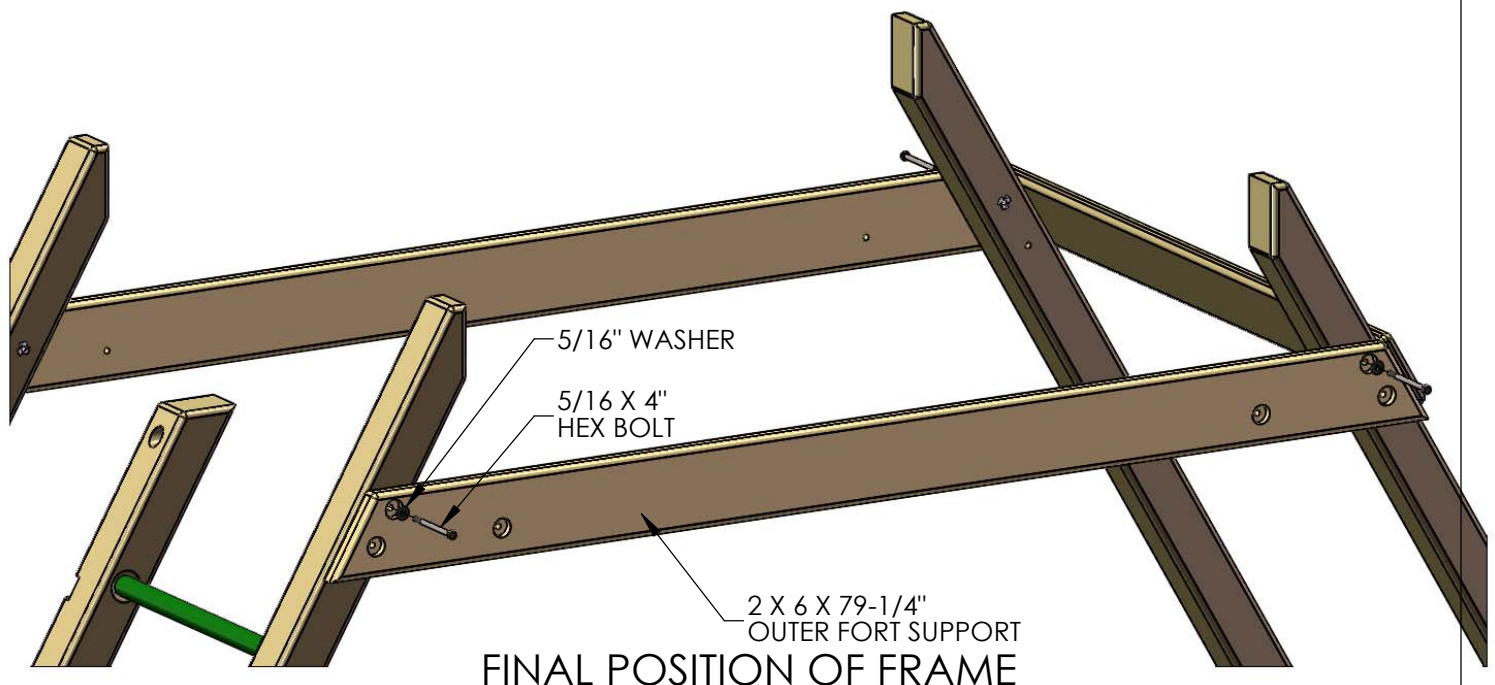

FINAL POSITION OF FRAME

STEP 8: INSTALLING INNER FORT SUPPORTS

- 1: FIND THE TWO 2 X 6 X 78-3/4" INNER FORT SUPPORTS.
- 2: LINE UP THE 3/8" HOLE CLOSEST TO THE BOTTOM WITH THE BOTTOM HOLE OF THE INNER FORT SUPPORT.
- 3: ATTACH THE INNER FORT SUPPORT TO THE LADDER ASSEMBLY WITH 5/16 X 4" HEX BOLTS AND 5/16" WASHERS.
- 4: REPEAT STEPS 2 AND 3 TO FASTEN THE INNER FORT SUPPORT TO THE ROCK WALL ASSEMBLY.

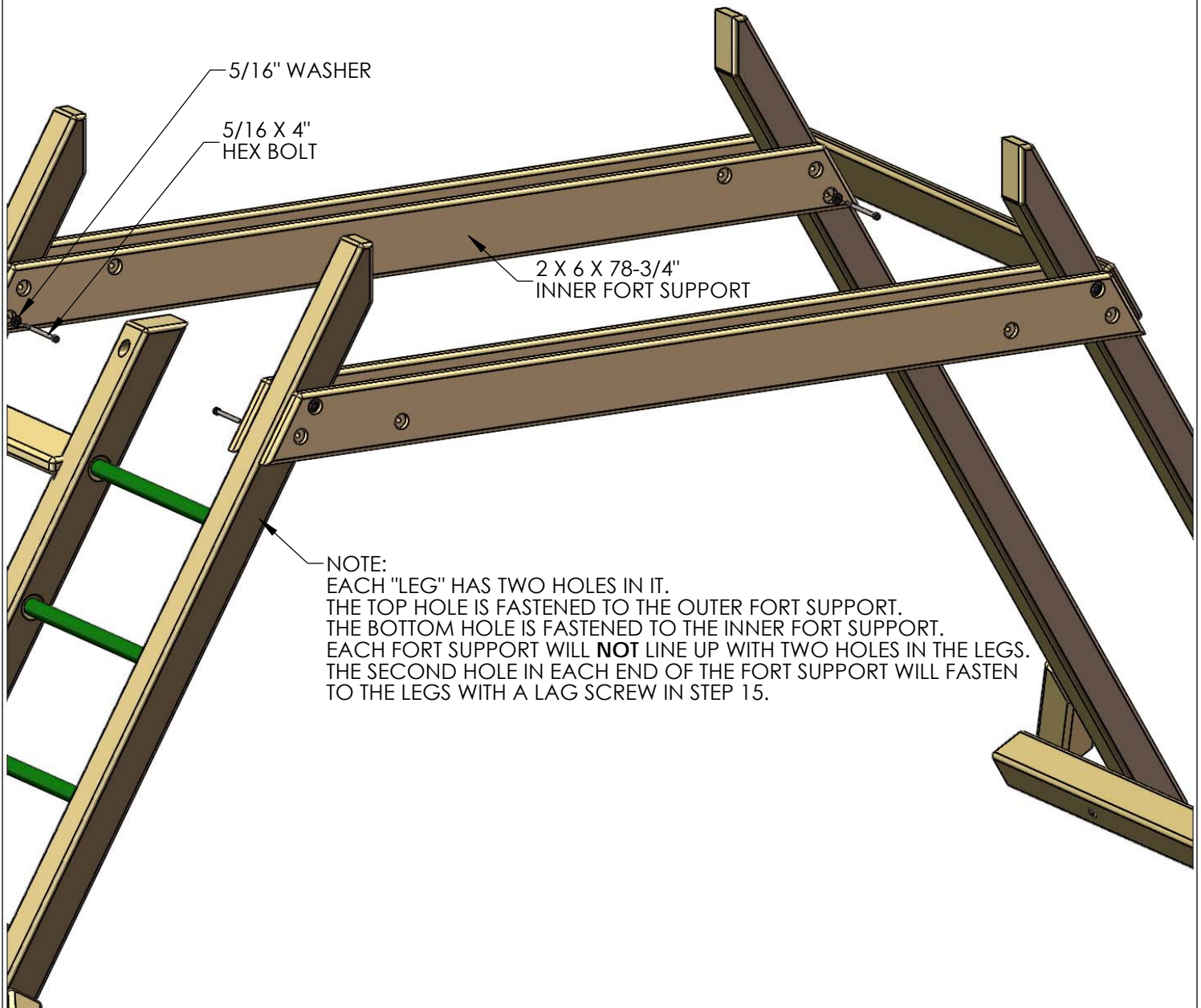

STEP 9: INSTALLING T-NUTS ON CORNER POSTS

- 1: FIND FOUR 4 X 4 X 61-1/4" CORNER POSTS. FRONT CORNER POSTS HAVE AN EXTRA HOLE AT 30-1/2" FROM THE BOTTOM.
- 2: USING THE DIAGRAM BELOW, INSTALL T-NUTS INTO THE APPROPRIATE HOLES. PLACE T-NUTS INTO THE HOLES OF THE CORNER POST AND SET WITH A HAMMER.
- 3: THE CORNER POSTS ARE SHOWN RELEVANT TO THEIR ORIENTATION ON THE UNIT.

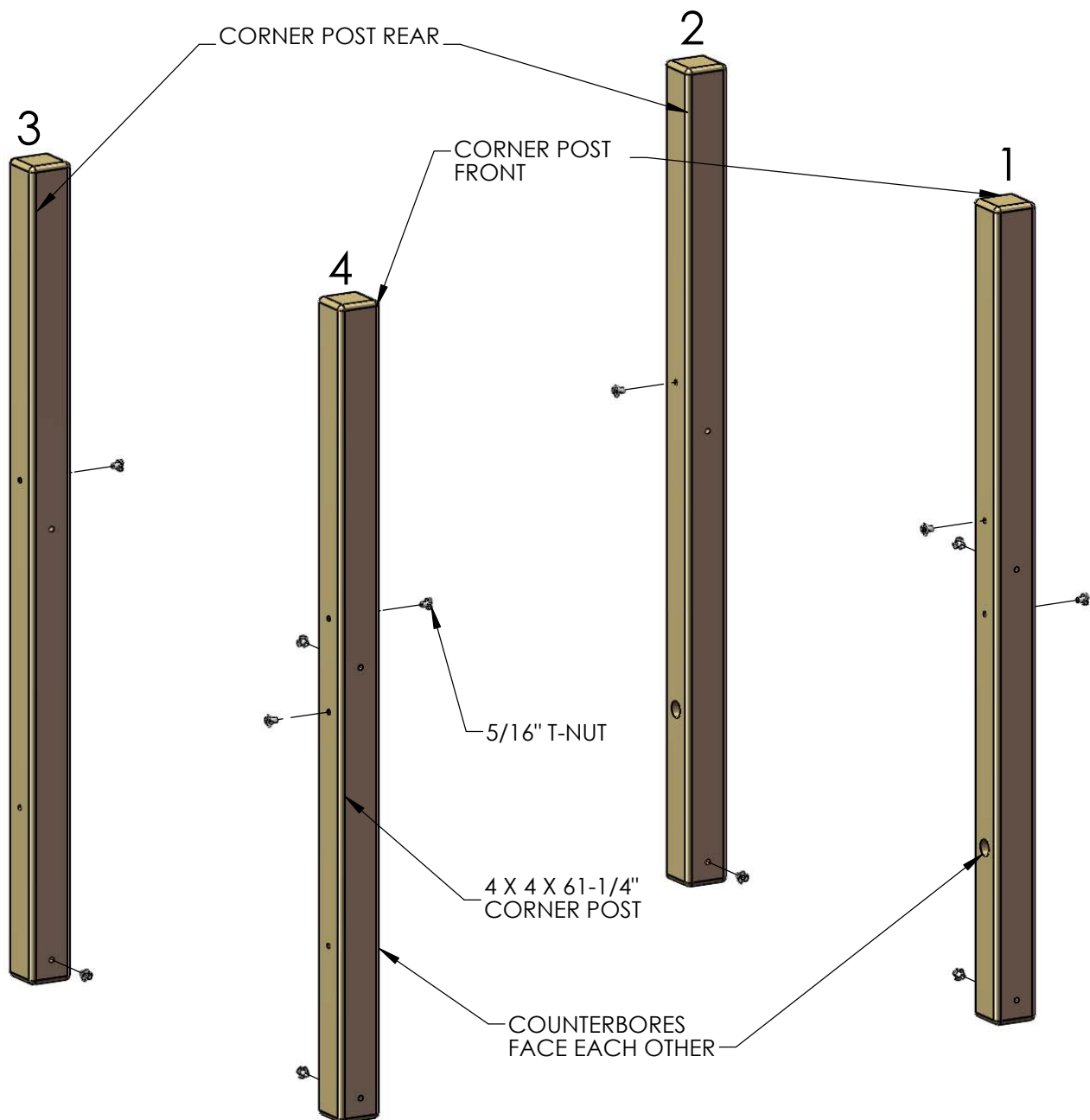

STEP 10: INSTALLING CORNER POSTS

- 1: TAKE THE CORNER POSTS WITH THE T-NUTS INSTALLED FROM THE PREVIOUS STEP AND ARRANGE THE POSTS IN THEIR PROPER ORIENTATION. (SHOWN BELOW WITH NUMBERS TO REFERENCE THE PREVIOUS STEP)
- 2: THE CORNER POSTS SHOULD BE ORIENTED WITH THE COUNTER-SUNK HOLES FACING TOWARD EACH OTHER ON BOTH SIDES. THE CORNER POSTS SHOULD BE PLACED BETWEEN THE INNER AND OUTER FORT SUPPORTS, AND REST FLUSH AGAINST THE ANGLED END OF THE LADDER AND ROCK WALL ASSEMBLIES. THE HOLES AT THE BOTTOM SHOULD BE LINED UP WITH THE COUNTER-SUNK HOLE OF THE OUTER FORT SUPPORT, AND THE T-NUTS ON THE HOLES SHOULD FACE EACH OTHER ON THE INSIDE OF THE FORT.
- 3: INSTALL THE CORNER POSTS WITH 5/16 X 4" HEX BOLTS AND 5/16" WASHERS.
- 4: DO NOT INSTALL ANY LAG SCREWS AT THIS TIME.

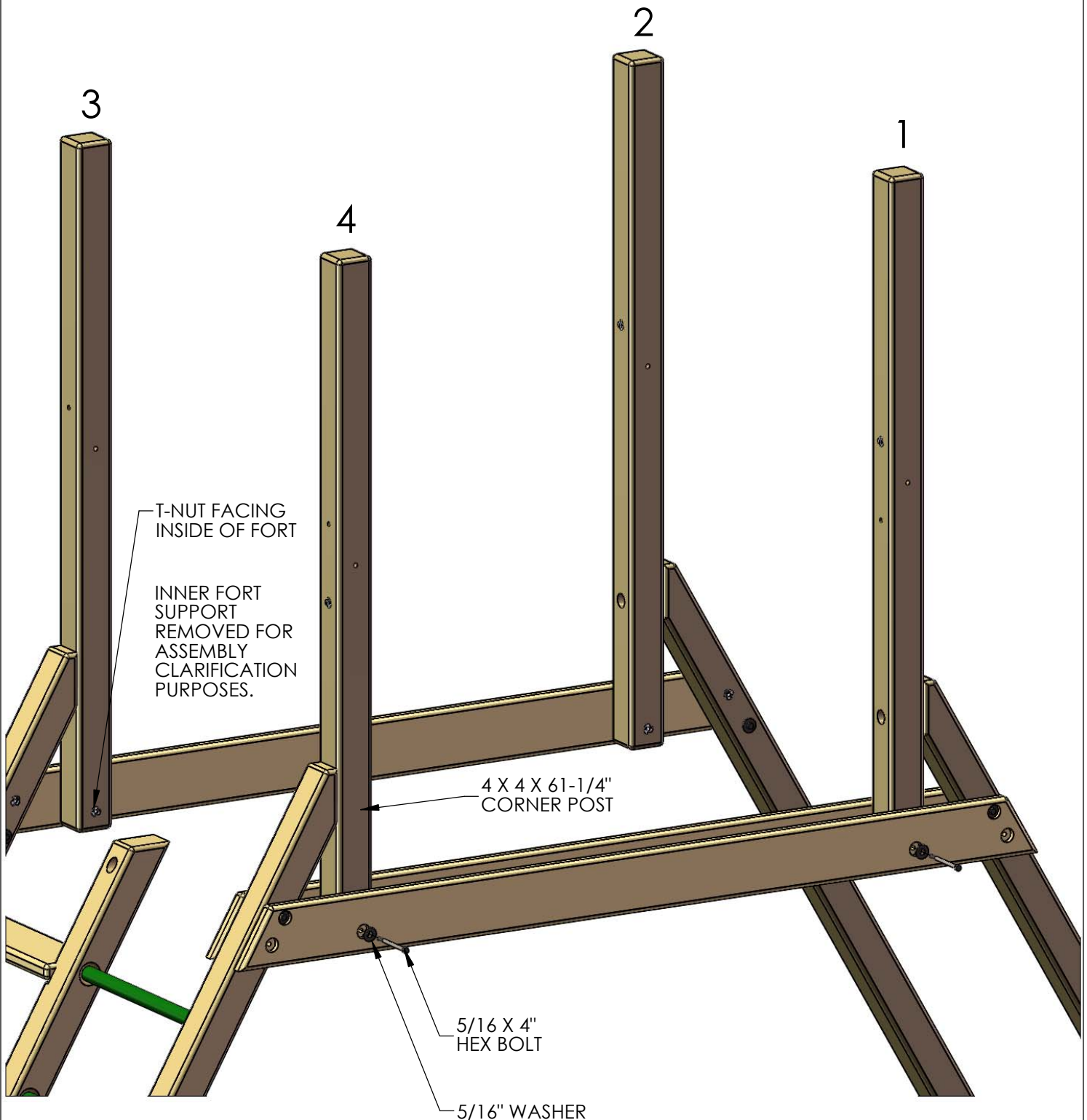

STEP 11: ATTACHING THE SWING BEAM PLATE TO THE SWING BEAM SIDE RAIL

1: FIND THE 4 X 4 X 120" SWING BEAM SIDE RAIL. NOTE THE DIFFERENCE BETWEEN THE SWING BEAM SIDE RAIL AND THE SIDE RAIL. THE SWING BEAM SIDE RAIL WILL HAVE THREE MORE COUNTER SUNK HOLES ON ONE SIDE THAN THE SIDE RAIL.

2: FIND THE SWING BEAM PLATE. NOTICE THE TWO SQUARE HOLES ON THE SWING BEAM PLATE.

3: PLACE THE SWING BEAM PLATE ON TOP OF THE SWING BEAM SIDE RAIL AND LINE UP THE THREE HOLES ON THE PLATE WITH THE THREE HOLES ON THE SWING BEAM SIDE RAIL. MAKE SURE THE COUNTER-SUNK HOLES ARE ON THE OPPOSITE SIDE OF THE SWING BEAM PLATE.

4: FASTEN THE SWING BEAM PLATE TO THE SWING BEAM SIDE RAIL WITH TWO 3-1/2" CARRIAGE BOLTS. THE SQUARE NECK OF THE CARRIAGE BOLT WILL FIT INSIDE THE SQUARE HOLES OF THE SWING BEAM PLATE. NO WASHER IS NEEDED.

5: FINISH INSTALLING THE SWING BEAM PLATE TO THE SWING BEAM SIDE RAIL WITH 3/8" WASHERS, AND 3/8" LOCK NUTS. INSTALL BOLT CAPS OVER ANY EXPOSED THREADS.

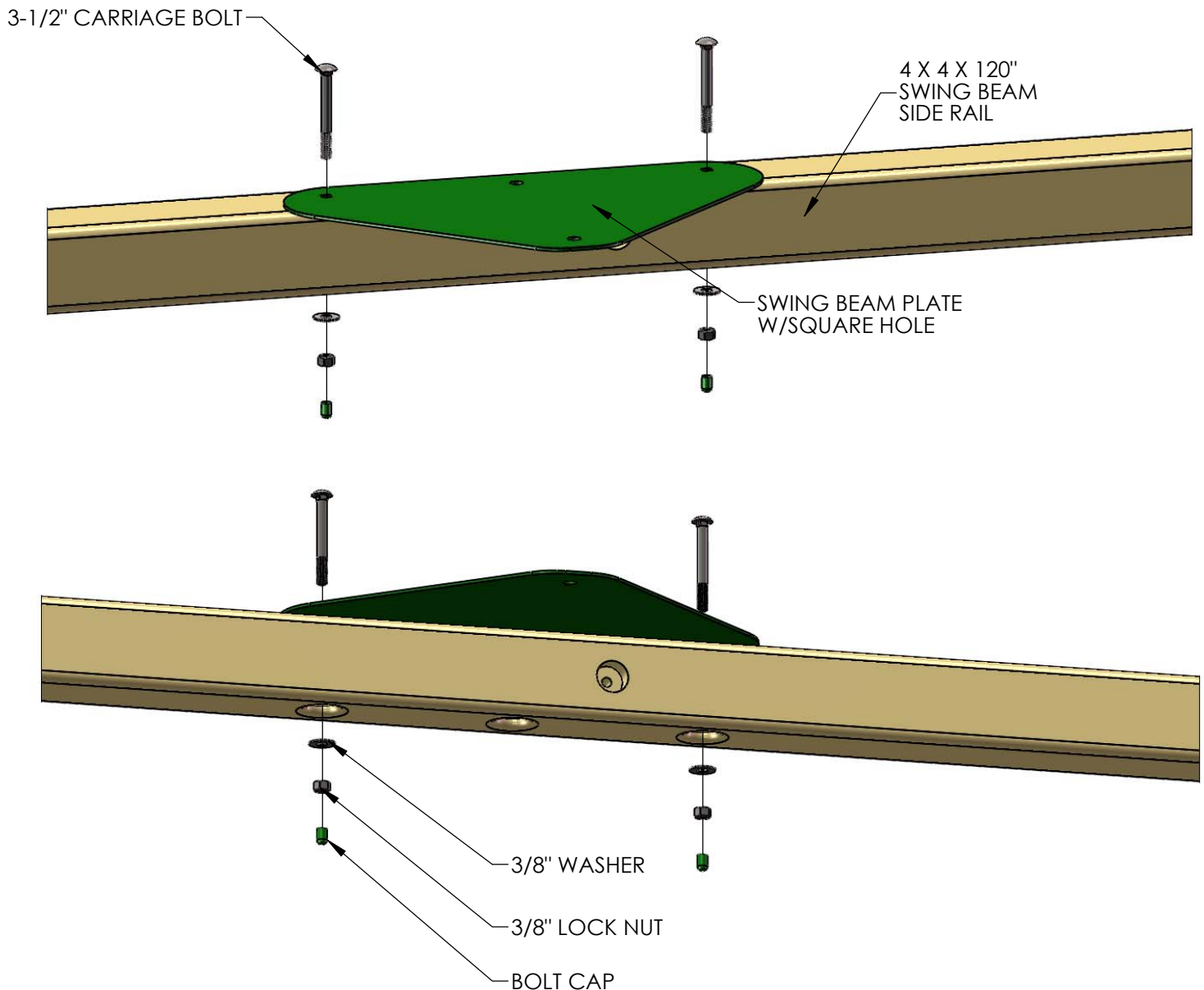

STEP 12: ATTACHING THE SWING BEAM SIDE RAIL

1: FIND TWO TORQUE WASHERS. PLACE A 7" CARRIAGE BOLT INSIDE THE TORQUE WASHER. PLACE THE TORQUE WASHER/CARRIAGE BOLT ASSEMBLY INTO THE HOLES OF THE CORNER POST SO THAT THE HEAD OF THE CARRIAGE BOLT IS INSIDE OF THE FORT.

2: TAKE THE 4 X 4 X 120" SWING BEAM SIDE RAIL WITH THE SWING BEAM PLATE AND LINE UP THE PILOT HOLES IN THE CORNER POSTS WITH THE HOLES IN THE SWING BEAM SIDE RAIL. PUSH THE CARRIAGE BOLTS THROUGH THE HOLES IN THE SWING BEAM SIDE RAIL.

3: FASTEN THE SWING BEAM SIDE RAIL TO THE FORT WITH 3/8" HEX NUTS AND 3/8" WASHERS. COVER ANY EXPOSED THREADS WITH BOLT COVERS.

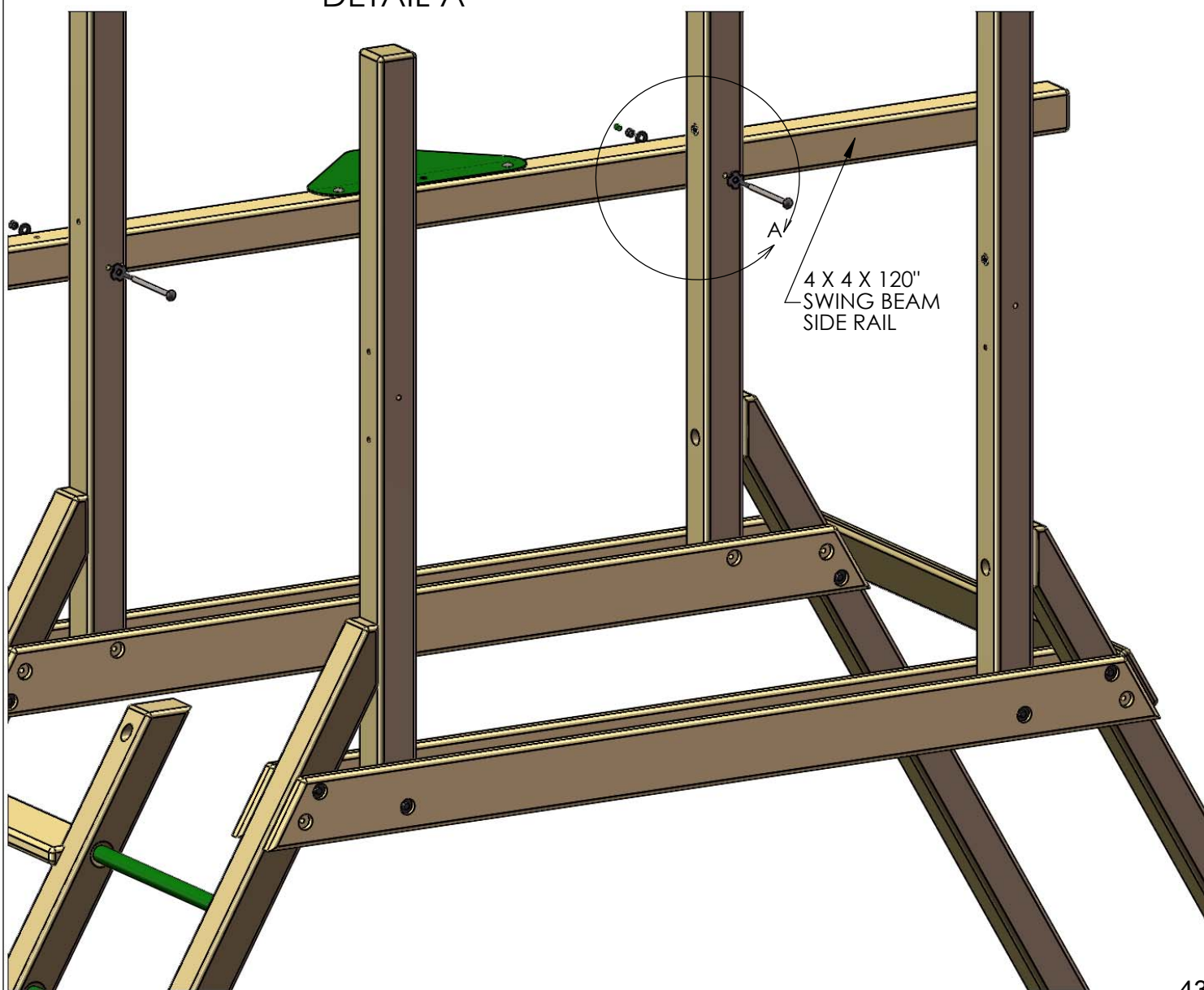
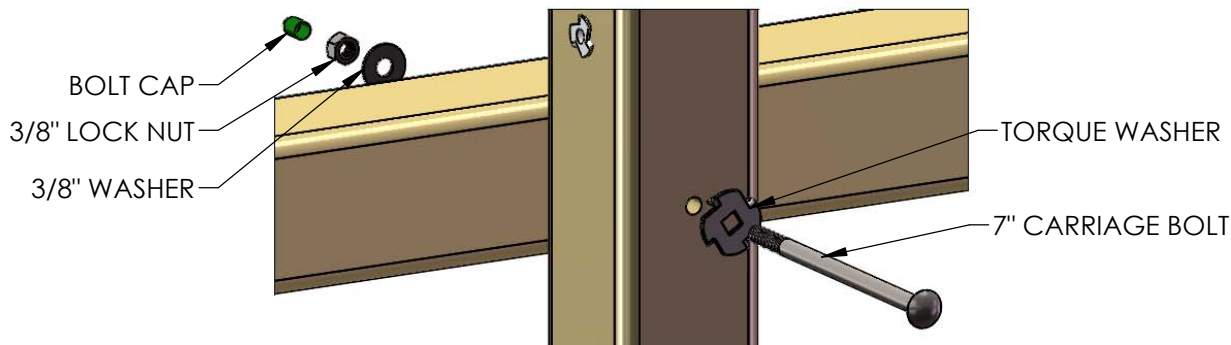

STEP 13: ATTACHING THE SIDE RAIL

1: TAKE THE 4 X 4 X 120" SIDE RAIL AND LINE UP THE PILOT HOLES IN THE CORNER POSTS WITH THE HOLES IN THE SIDE RAIL.

2: FASTEN THE SIDE RAIL TO THE FORT WITH 5/16 X 6" HEX BOLTS AND 5/16" WASHERS INTO THE T-NUTS OF THE CORNER POSTS.

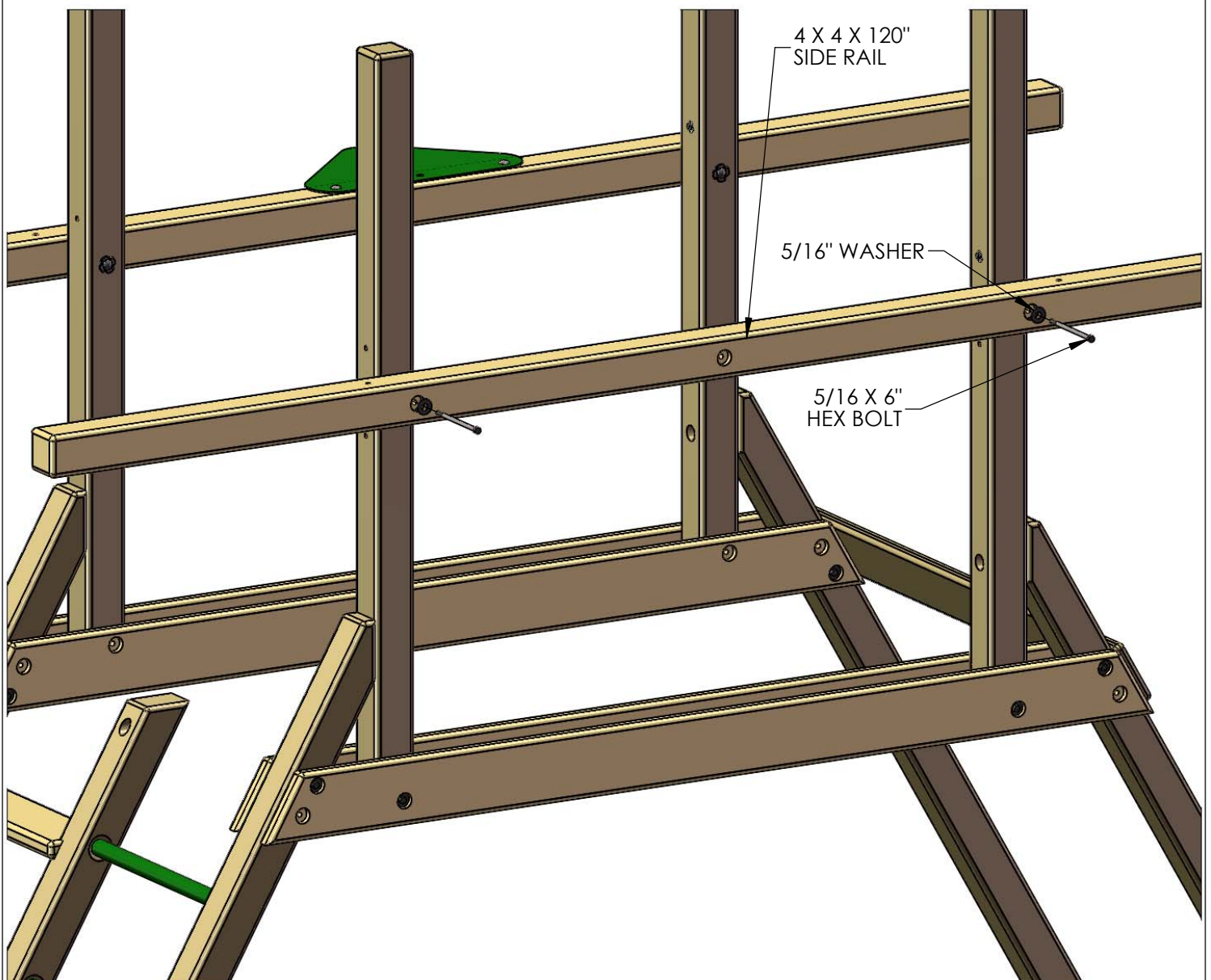

STEP 14: ATTACHING THE ROPE LADDER SUPPORT AND THE ROCK WALL ROPE SUPPORT

1: FIND THE 4 X 4 X 88" ROPE LADDER SUPPORT AND LAY IT ON TOP OF THE SIDE RAIL AND THE SWING BEAM SIDE RAIL ON THE LADDER SIDE OF THE FORT.

2: LINE UP THE COUNTER-SUNK HOLES OF THE ROPE LADDER SUPPORT WITH THE HOLES IN THE CORNER POSTS AND ATTACH WITH 5/16 X 6" HEX BOLTS WITH 5/16" WASHERS. THE THREE HOLES ON THE END OF THE ROPE LADDER SUPPORT SHOULD BE ON THE OPPOSITE SIDE OF THE SWING BEAM PLATE BEFORE INSTALLING.

3: FIND THE 4 X 4 X 55" ROCK WALL ROPE SUPPORT AND LAY IT ON TOP OF THE SIDE RAIL AND THE SWING BEAM SIDE RAIL ON THE ROCK WALL SIDE OF THE FORT.

4: LINE UP THE COUNTER-SUNK HOLES OF THE ROCK WALL ROPE SUPPORT WITH THE HOLES IN THE CORNER POSTS AND ATTACH WITH 5/16 X 6" HEX BOLTS WITH 5/16" WASHERS.

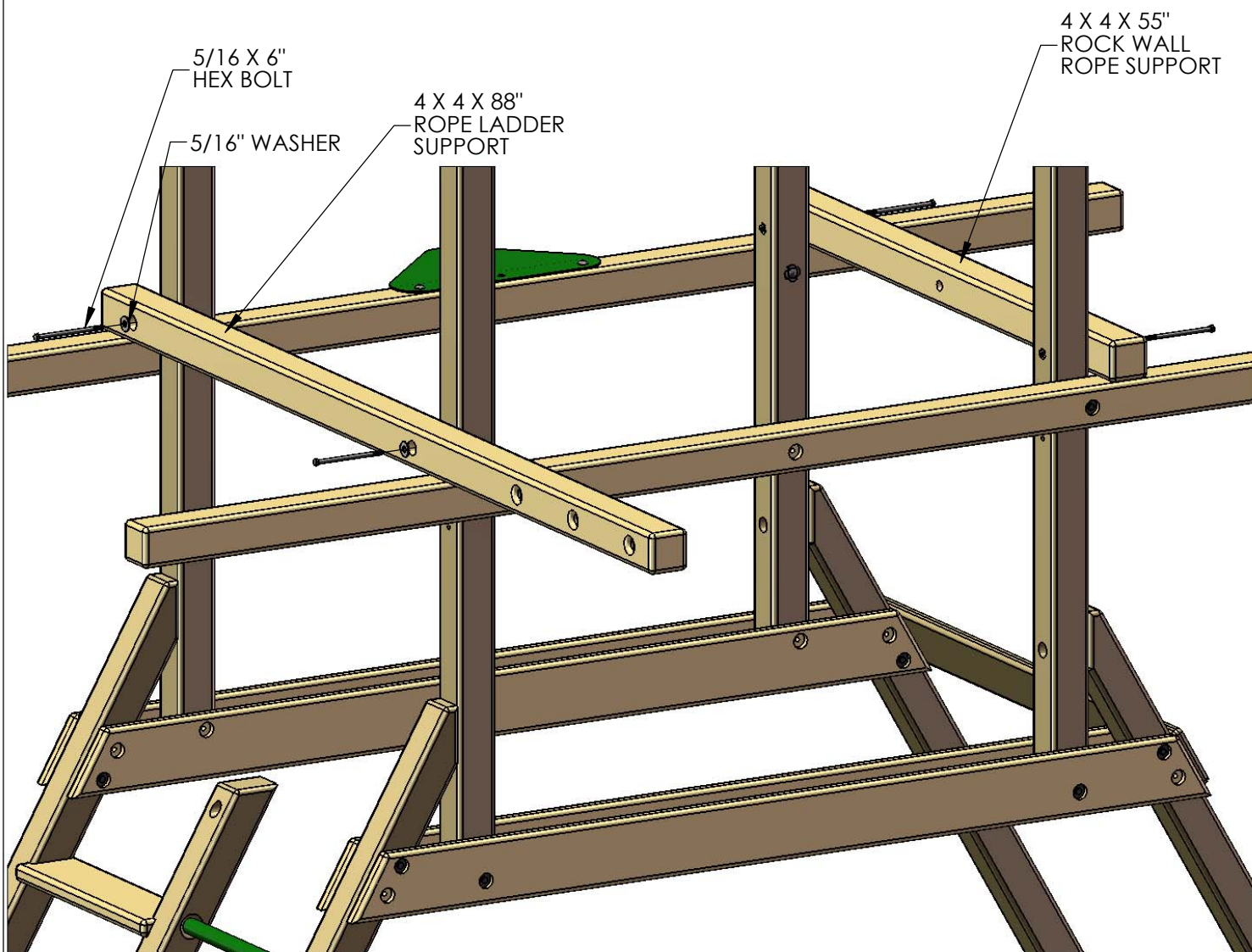

STEP 15: INSTALLING LAG SCREWS

1: MAKE SURE THAT THE UNIT IS LEVEL AND SQUARE.

2: STARTING AT THE INNER AND OUTER FORT SUPPORTS, USE 3/8" X 3-1/2" LAG SCREWS WITH 3/8" WASHERS IN THE EMPTY HOLES ON THE 2 X 6 PARTS TO SECURE THE BASE OF THE FORT.

3: THE UPPER PART OF THE FORT NEEDS TO BE SECURED WITH 3/8" X 5" LAG SCREWS WITH 3/8" WASHERS IN THE EMPTY HOLES OF THE 4 X 4 PARTS.

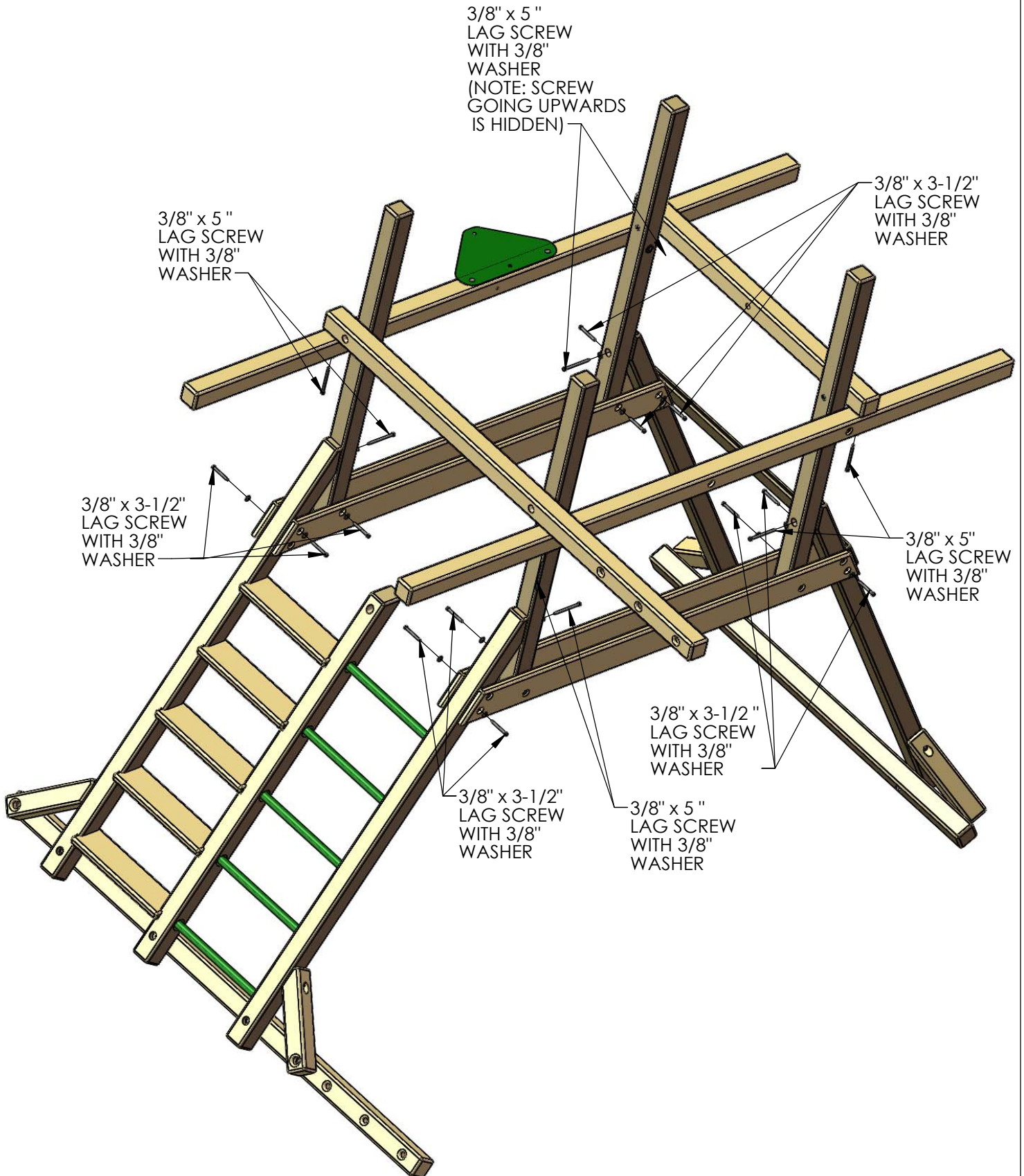

STEP 16: INSTALLING ROCK WALL BOARDS

- 1: FIND ELEVEN 5/4 X 6 X 48" ROCK WALL BOARDS.
- 2: LAY THE ROCK WALL BOARDS ACROSS THE ROCK WALL SIDES.
- 3: ATTACH THE ROCKS WITH TWO 2" WOOD SCREWS PER END.
- 4: THE FINAL BOARD WILL BE THE 5/4 X 6 X 48" BOTTOM ROCK WALL BOARD WITH ONE HOLE IN THE CENTER. IT WILL ATTACH IN THE SAME MANNER AS THE OTHER ROCK WALL BOARDS.
- 5: AFTER ASSEMBLY, YOUR ROCK WALL MAY HAVE A GAP AT THE BOTTOM. THIS IS NORMAL DUE TO MILLING VARIANCES AND WOOD SHRINKAGE.

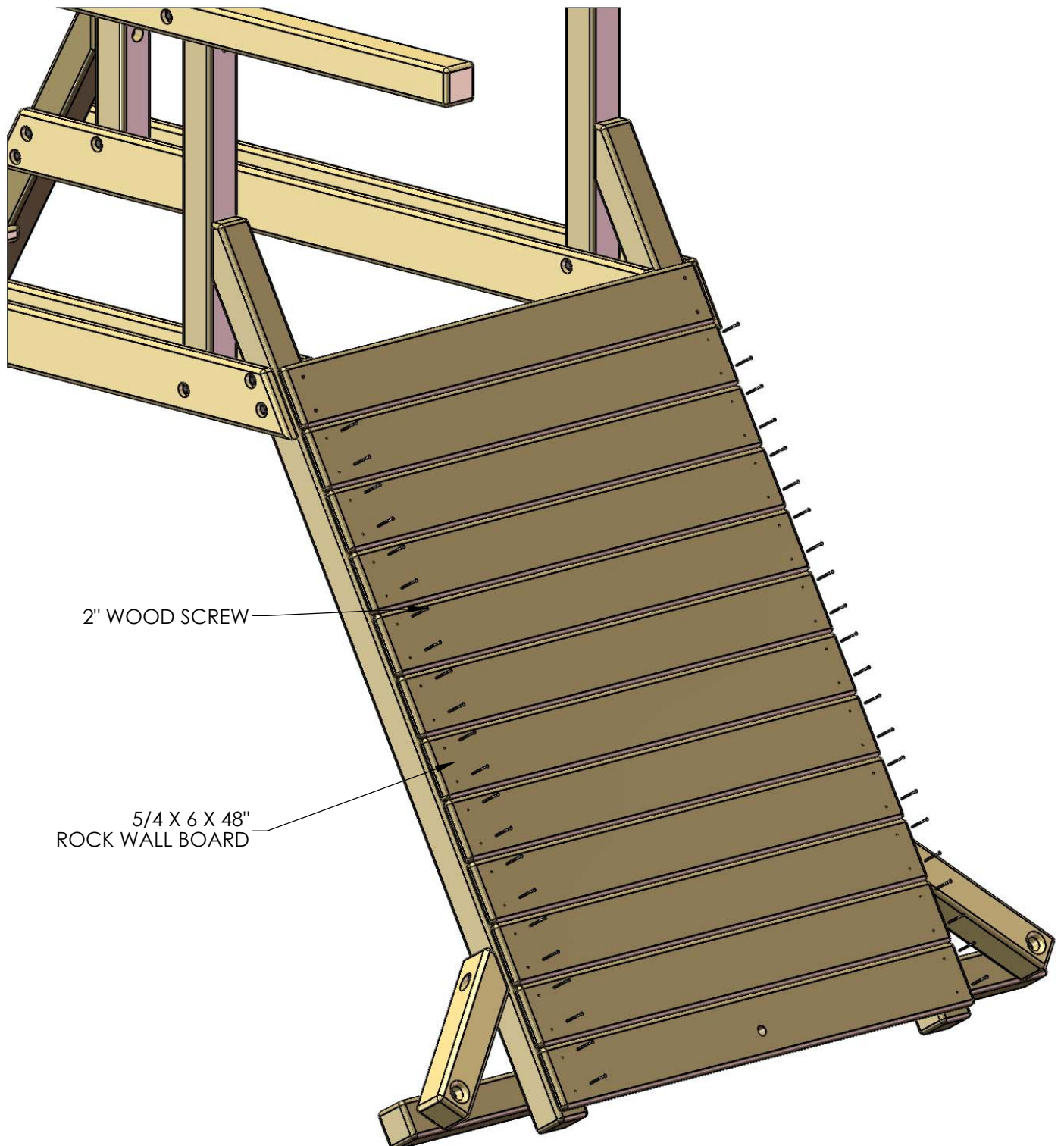

STEP 17: INSTALLING TARP BOARDS

- 1: FIND TWO 2 X 4 X 54-1/2" TARP BOARDS.
- 2: CENTER THE BOARD ACROSS THE ENDS OF THE SWING BEAM SIDE RAIL AND THE SIDE RAIL.
- 3: ATTACH THE TARP BOARDS WITH 3/8 X 3-1/2" LAG SCREWS AND 3/8" WASHERS.
- 4: REPEAT THIS PROCESS ON THE OPPOSITE SIDE OF THE FORT.

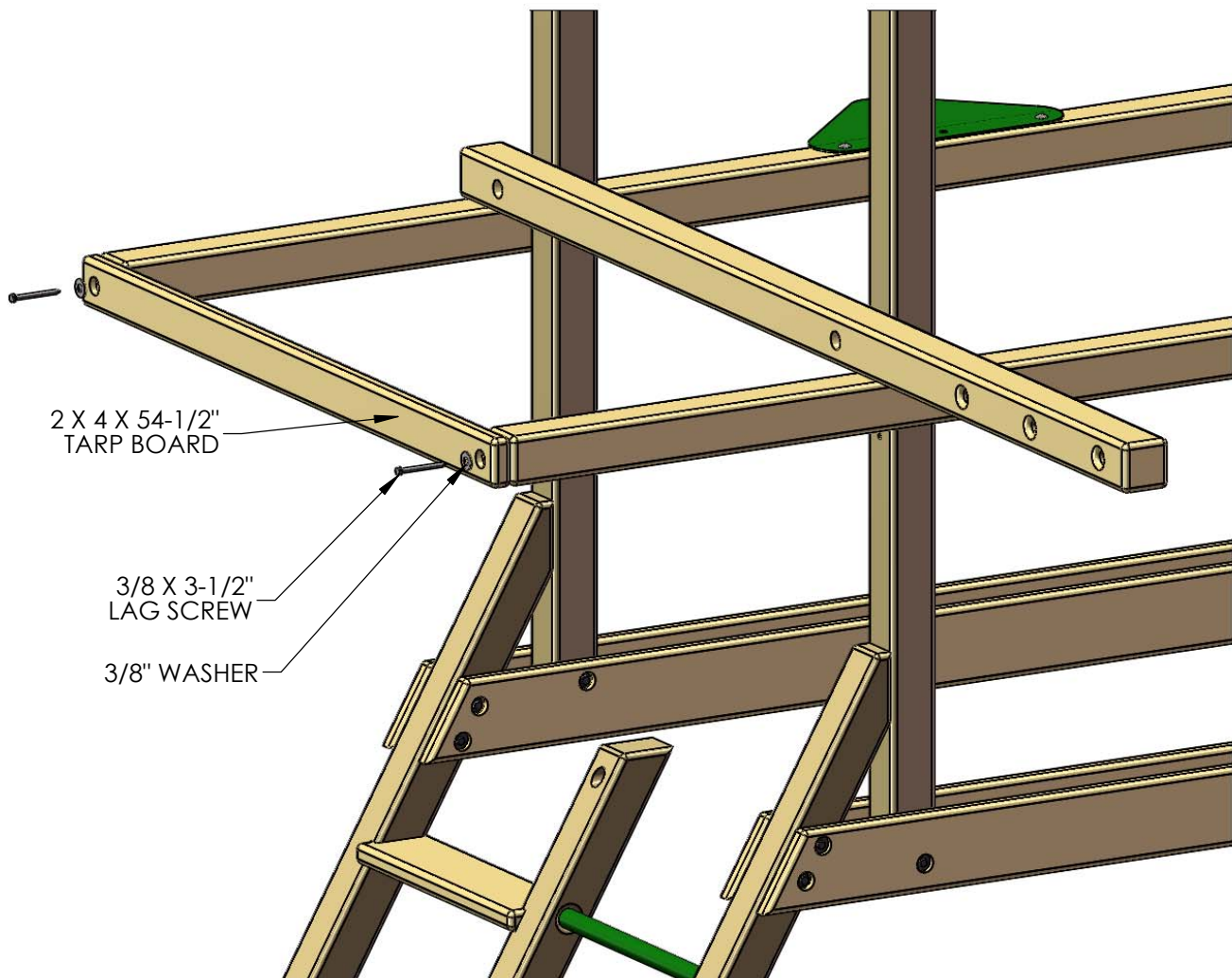

STEP 18: DECK

- 1: FIND NINE 2 X 6 X 50-3/4" DECK BOARDS.
- 2: LAY THE DECK BOARDS ACROSS THE INNER FORT SUPPORTS, BETWEEN THE BOTTOM AND REAR BOTTOM PANEL BOARDS, AND INSIDE THE AREA BETWEEN THE CORNER POSTS.
- 3: FIND FOUR 2 X 6 X 41-1/4" DECK SPACERS.
- 4: LAY TWO DECK SPACERS ACROSS THE INNER FORT SUPPORTS ON THE LADDER AND ROCK WALL SIDES OF THE FORT.
- 5: MAKE SURE THAT ALL BOARDS ARE EVENLY SPACED ACROSS THE DECK AND ATTACH THE DECK BOARDS AND DECK SPACERS TO THE FORT WITH TWO 2-1/2" WOOD SCREWS PER SIDE.

**MAKE SURE ALL BOARDS ARE EVENLY SPACED
ACROSS THE DECK BEFORE SECURING**

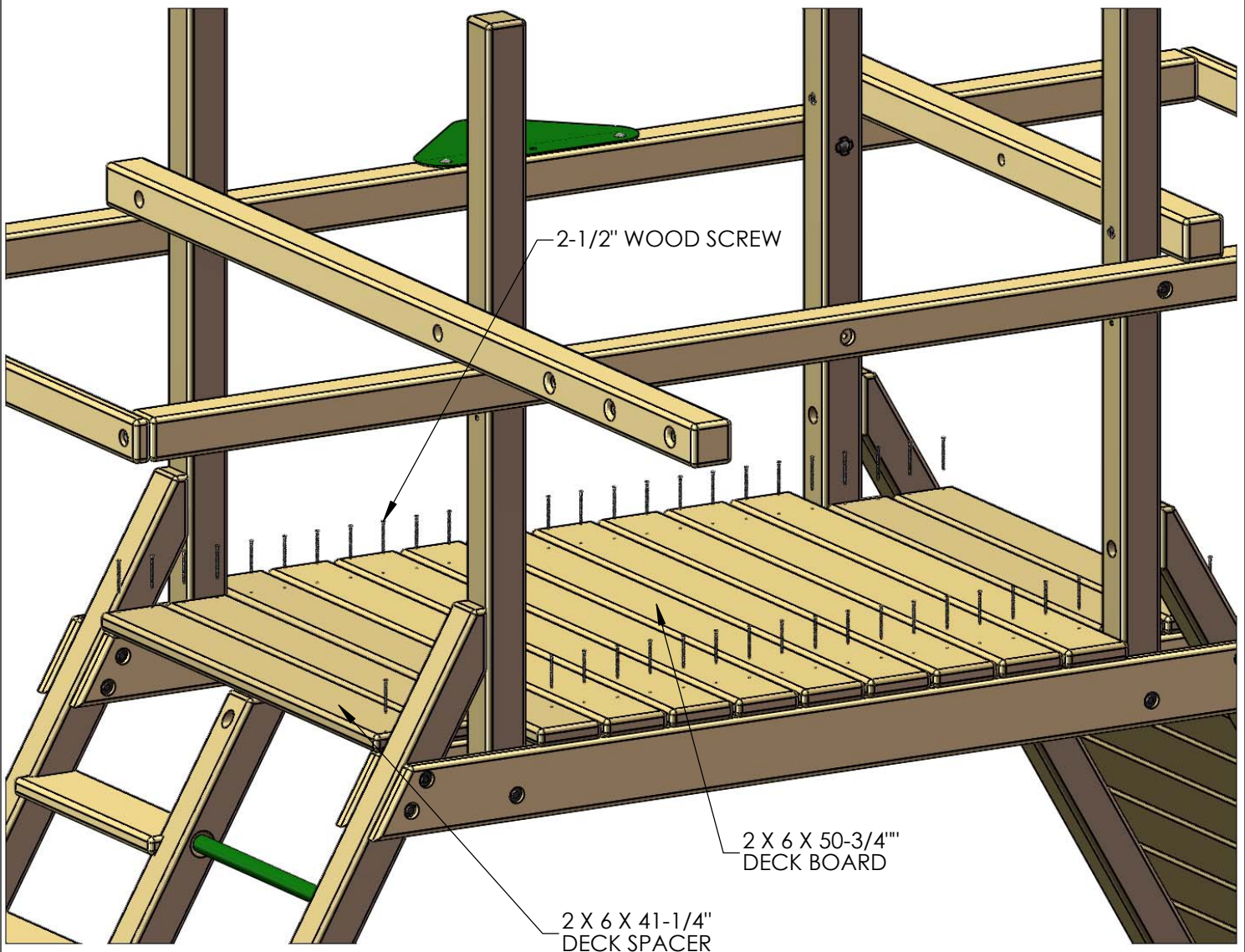

STEP 19: INSTALLING THE BOTTOM PANEL BOARDS

- 1: FIND TWO 2 X 4 X 58" REAR BOTTOM PANEL BOARDS.
- 2: LAY ONE BOARD ACROSS THE DECK ON THE SWING BEAM SIDE OF THE FORT, CENTERED BETWEEN THE TWO CORNER POSTS (INSTALL OUTSIDE).
- 3: ATTACH THE REAR BOTTOM PANEL BOARD WITH 3/8 X 3-1/2" LAG SCREWS AND 3/8" WASHERS.
- 4: LAY ONE BOARD ACROSS THE DECK ON THE OPPOSITE SIDE OF THE FORT, CENTERED BETWEEN THE TWO CORNER POSTS (INSTALL INSIDE).
- 5: ATTACH THE REAR BOTTOM PANEL BOARD WITH 3/8 X 3-1/2" LAG SCREWS AND 3/8" WASHERS.

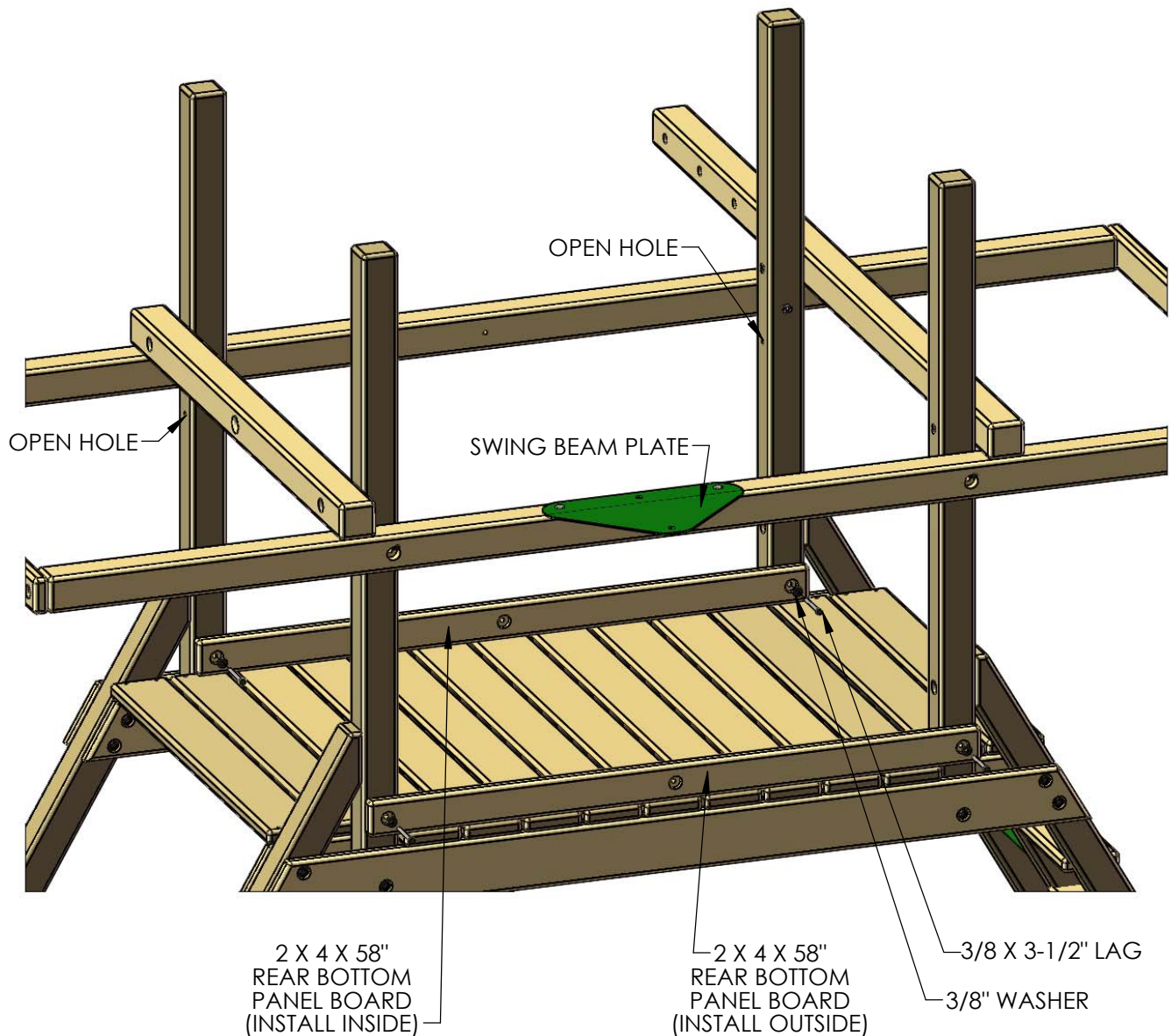

STEP 20: CENTER POSTS

- 1: TAKE THE 4 X 4 X 29-1/2" CENTER POSTS, AND LINE UP THE HOLE IN THE POSTS WITH THE THROUGH HOLE IN THE SWING BEAM SIDE RAIL/SIDE RAIL.
- 2: WHEN THE CENTER POST IS LINED UP PROPERLY, INSTALL A 5/16" T-NUT INTO THE HOLE IN THE CENTER POSTS.
- 3: FASTEN THE CENTER POSTS TO THE FORT WITH 5/16 X 6" HEX BOLTS AND 5/16" WASHERS THROUGH THE SWING BEAM SIDE RAIL/SIDE RAIL, AND INTO THE T-NUTS OF THE CENTER POST.
- 4: MAKE SURE THAT THE CENTER POST ON BOTH SIDES ARE SQUARE AND LEVEL, AND FASTEN IT TO THE BOTTOM PANEL BOARD WITH A 3/8 X 3-1/2" LAG SCREW AND A 3/8" WASHER.
- 5: UNDERNEATH THE DECK ATTACH THE DECK BOARD TO THE BOTTOM OF EACH CENTER POST WITH TWO 3" WOOD SCREWS.

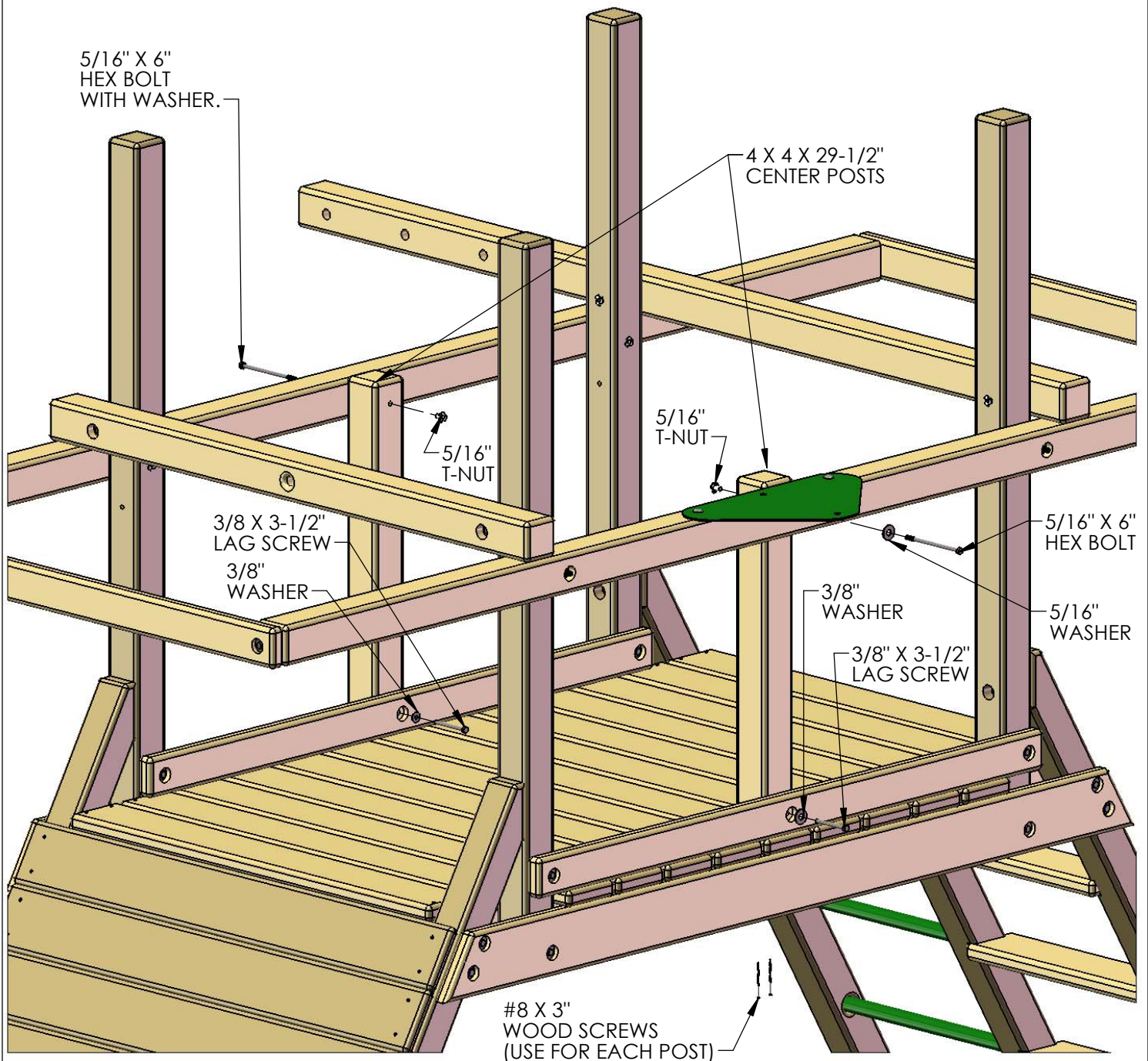

STEP 21: ROOF SUPPORT ASSEMBLIES

1: IF YOUR ROOF PEAK SUPPORTS ARE NOT PREDRILLED THEN DRILL 1/8" HOLES IN THEM TO THE PATTERN SHOWN BELOW.

2: PLACE THE ENDS OF THE ROOF SUPPORTS TOGETHER AS SHOWN BELOW. THE HOLES SHOULD BE ABOUT 55" CENTER TO CENTER.

3: PLACE THE ROOF PEAK SUPPORT (TRIANGLE) ON TOP OF THE ROOF SUPPORTS. ATTACH THE ROOF PEAK SUPPORT TO THE ROOF SUPPORTS WITH #8 X 2" WOOD SCREWS.

4: REPEAT THIS PROCESS TO MAKE ANOTHER ROOF SUPPORT ASSEMBLY.

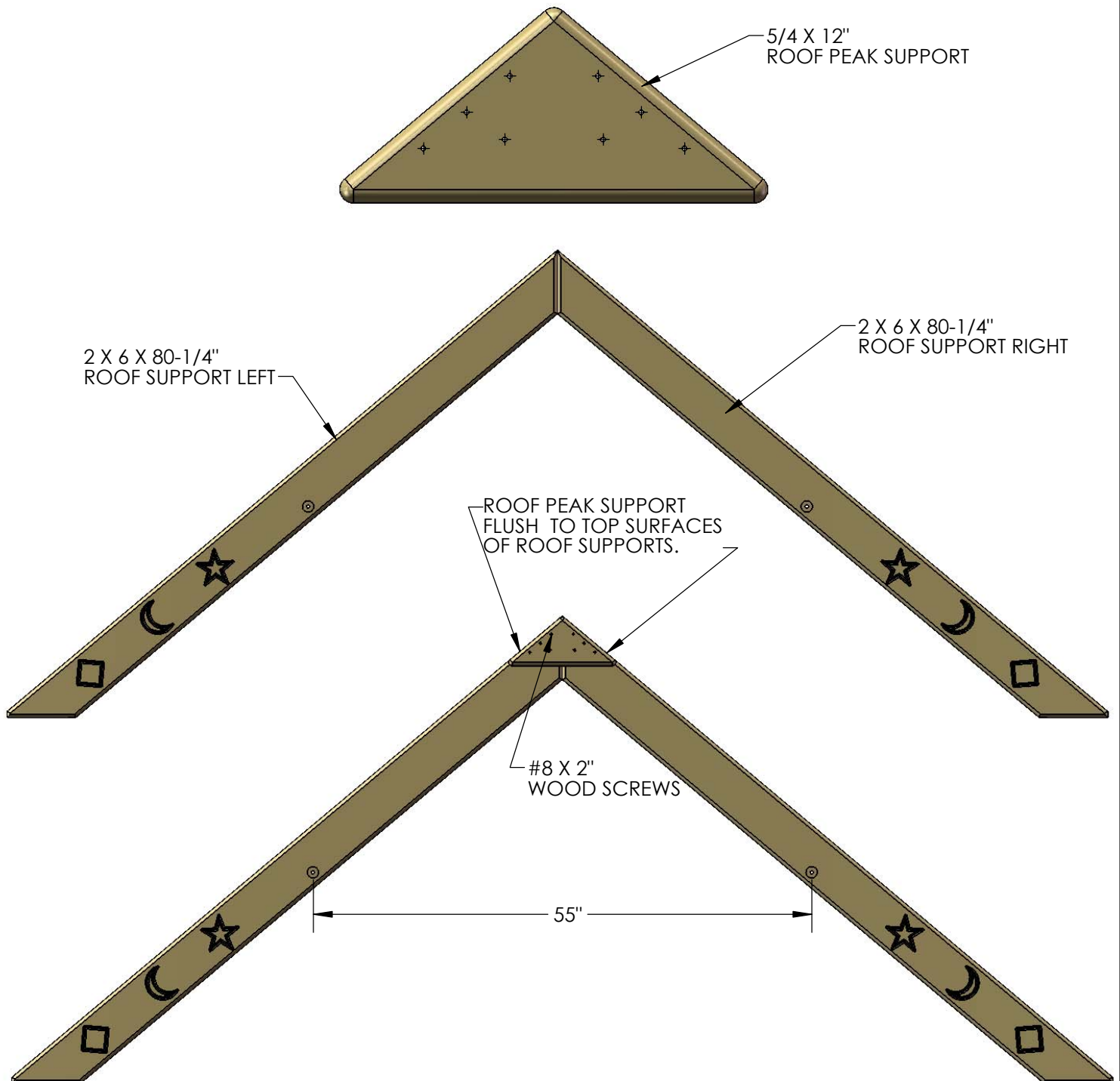

STEP 21A: ROOF SUPPORTS

- 1: HAVE AN ASSISTANT HELP YOU LIFT THE ROOF SUPPORT ASSEMBLIES ON TOP OF THE SIDE RAIL OR SWING BEAM SIDE RAIL. DO THEM ONE AT A TIME.
- 2: PLACE A RULER OR BOARD ON TOP OF THE SIDE RAILS TO CHECK AND MAKE SURE THERE IS NO INTERFERENCE WITH THE END TARP BOARDS. DO THIS ON BOTH SIDES.
- 3: THE HOLES IN THE ROOF SUPPORTS SHOULD BE CLOSE TO BEING CENTERED ON EACH CORNER POST. ATTACH THE ROOF SUPPORTS TO THE CORNER POSTS WITH 3/8 X 3-1/2" LAG SCREWS AND 3/8" WASHERS.

PLACE A RULER OR BOARD HERE TO MAKE SURE WHEN THE ROOF FINISHERS ARE INSTALLED THEY CLEAR THE END TARP BOARDS.

END TARP BOARDS

DETAIL C
SCALE 1 : 8

ROOF SUPPORT ASSEMBLIES

DESIGN FACES OUT ON BOTH SIDES OF THE PLAY SET

3/8" WASHER

3/8 X 3-1/2"
LAG SCREW

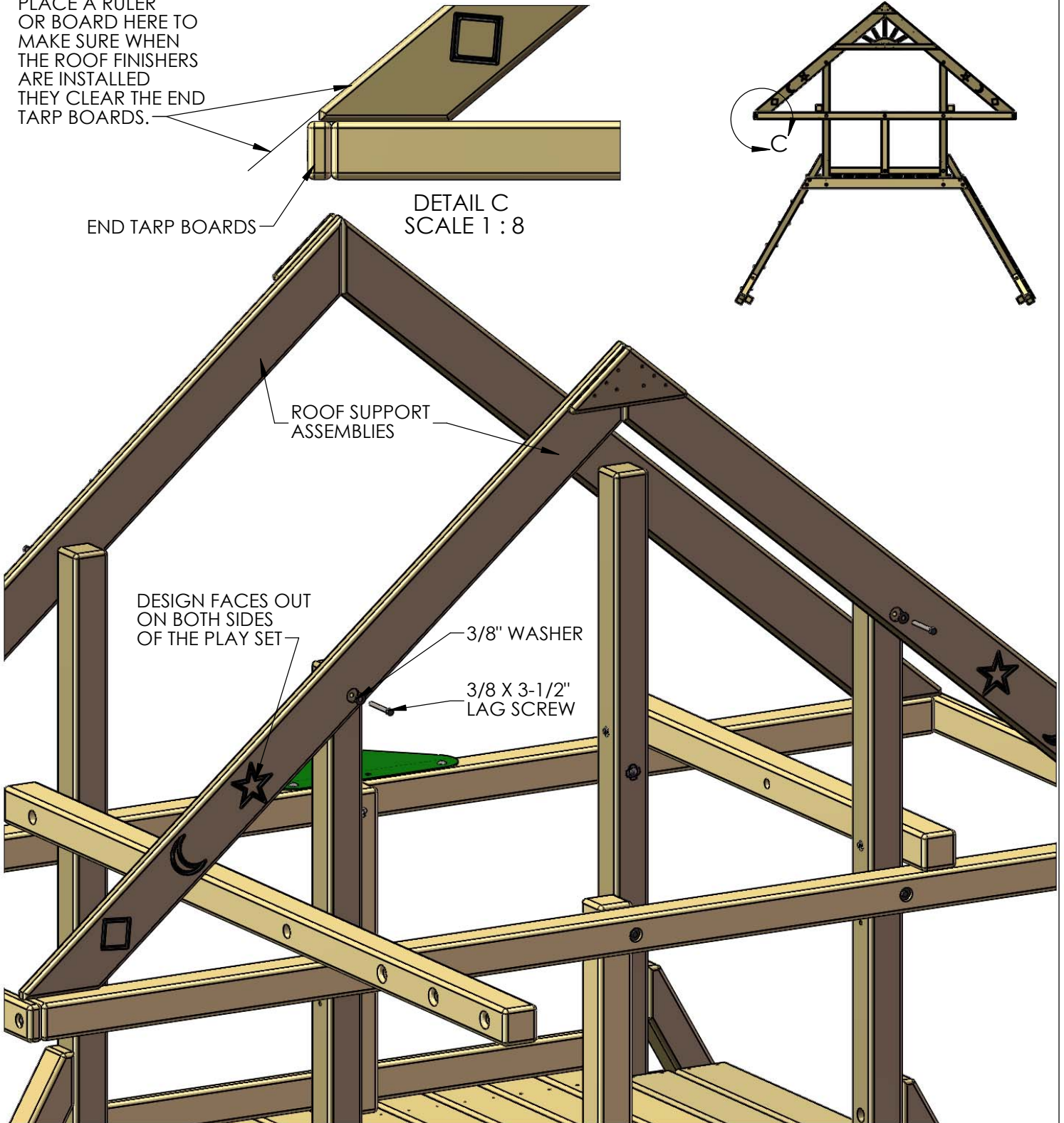
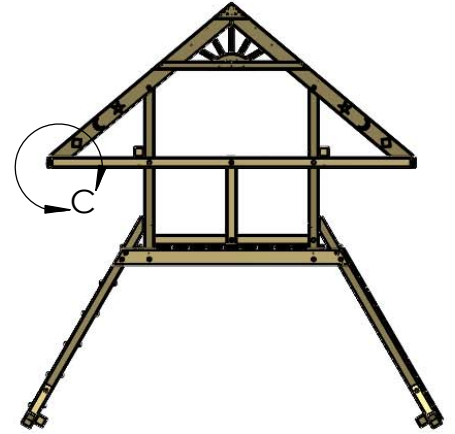

STEP 22: PANEL SLATS

- 1: FIND SIX 5/4 X 4 X 28-1/2" PANEL SLATS, AND ARRANGE THEM SO THAT THEY ARE EVENLY SPACED ACROSS THE SWING BEAM SIDE OF THE FORT.
- 2: ATTACH THE PANEL SLATS WITH TWO 2" WOOD SCREWS PER END.

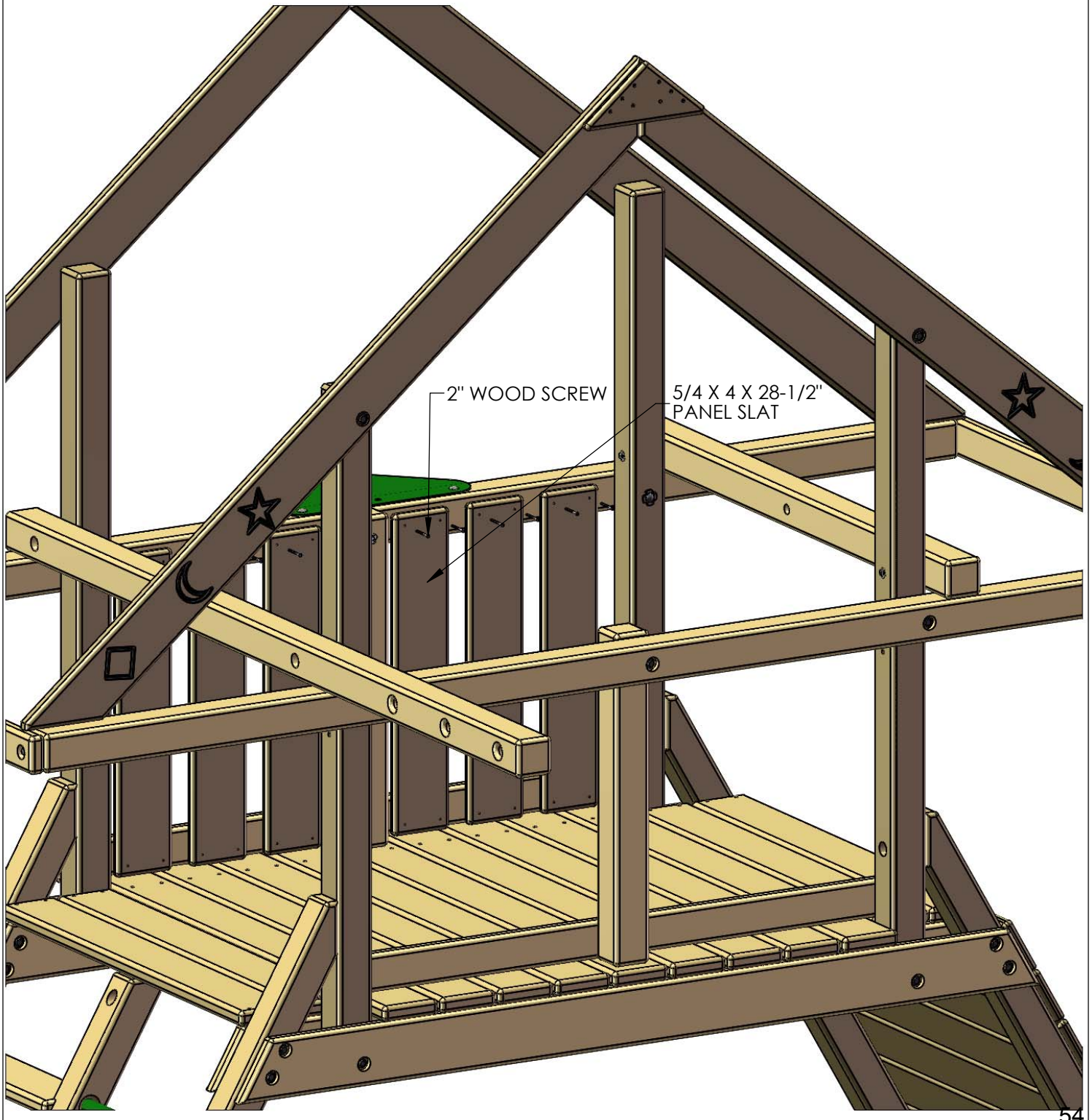

STEP 23: CENTER DECK SUPPORTS

- 1: FIND THE 4 X 4 X 70" TIRE SWING SUPPORT, AND ARRANGE EVENLY UNDERNEATH THE DECK.
- 2: ATTACH THE TIRE SWING SUPPORT WITH A 3/8 X 5" LAG SCREW AND A 3/8" WASHER THROUGH THE LADDER CENTER. FROM THE TOP, ADD TWO 2-1/2" WOOD SCREWS THROUGH THE DECK BOARDS, INTO THE CENTER DECK SUPPORT.
- 3: FIND THE 2 X 4 X 58" ROCK WALL SUPPORT BOARD, AND CENTER IT ON THE BACK OF THE ROCK WALL. MAKE SURE THAT THE HOLE IN THE BOTTOM ROCK WALL BOARD IS NOT OBSTRUCTED BY THE ROCK WALL SUPPORT BOARD.
- 4: THE ROCK WALL SUPPORT BOARD WILL ATTACH TO THE ROCK WALL WITH TWO 2" WOOD SCREWS PER END, AND AN ADDITIONAL 2" WOOD SCREW IN THE MIDDLE OF THE ROCK WALL SUPPORT BOARD AT EACH ROCK WALL BOARD. FROM THE FRONT OF THE ROCK WALL, ADD TWO 2" WOOD SCREWS THROUGH THE ROCK WALL BOARDS, INTO THE ROCK WALL SUPPORT BOARD.

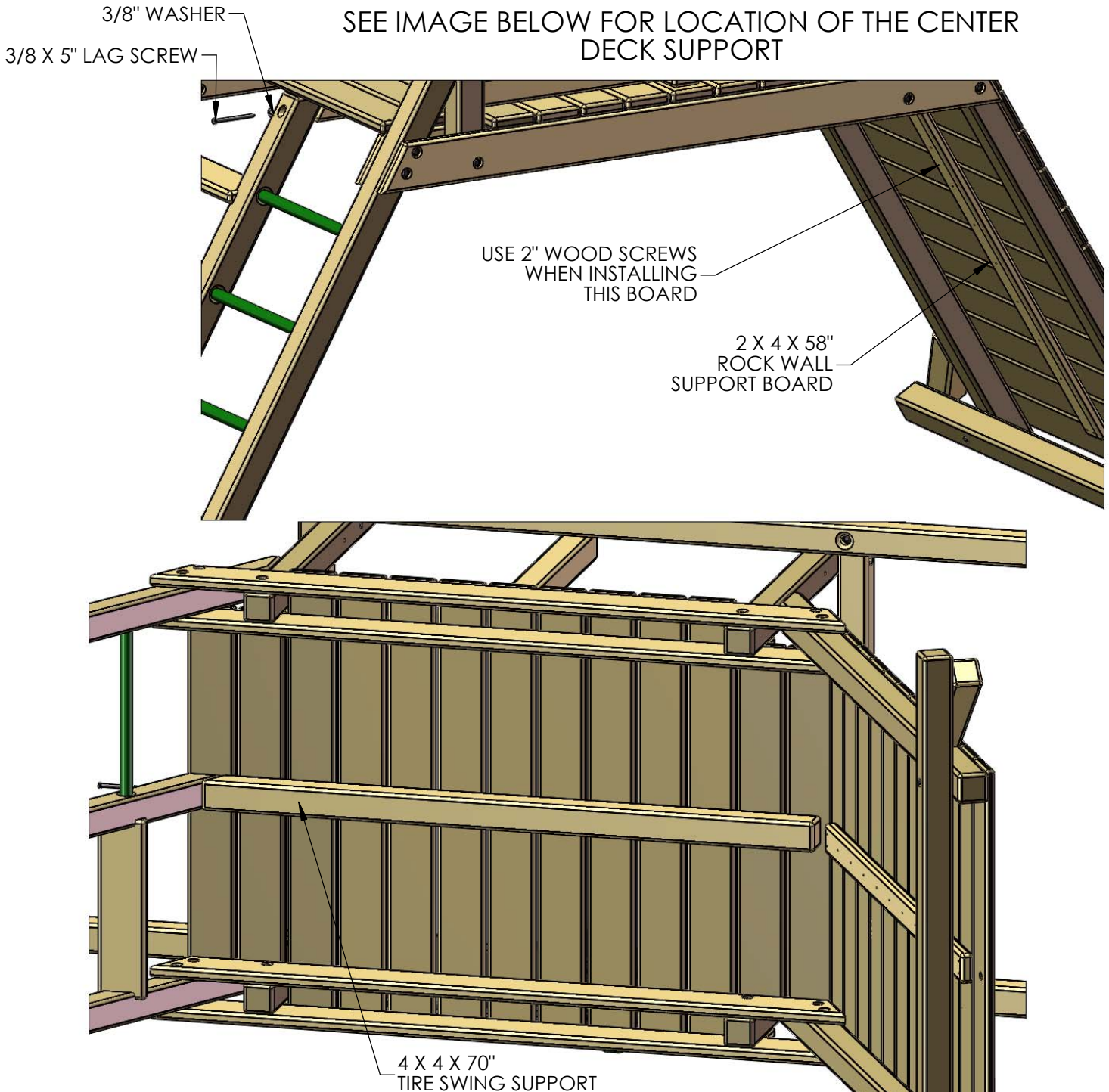

VIEW FROM THE BOTTOM OF THE FORT

STEP 24: IRON DUCTILES

1: LINE UP THE HOLES OF THE IRON DUCTILES WITH THE HOLES IN THE SWING BEAM.

2: FASTEN THE IRON DUCTILES TO THE SWING BEAM USING 7" CARRIAGE BOLTS WITH TORQUE WASHERS ON TOP OF THE SWING BEAM, AND 3/8" LOCK NUTS AND WASHERS ON THE BOTTOM. PLACE GREEN BOLT CAPS OVER EXPOSED THREADS AFTER SECURING.

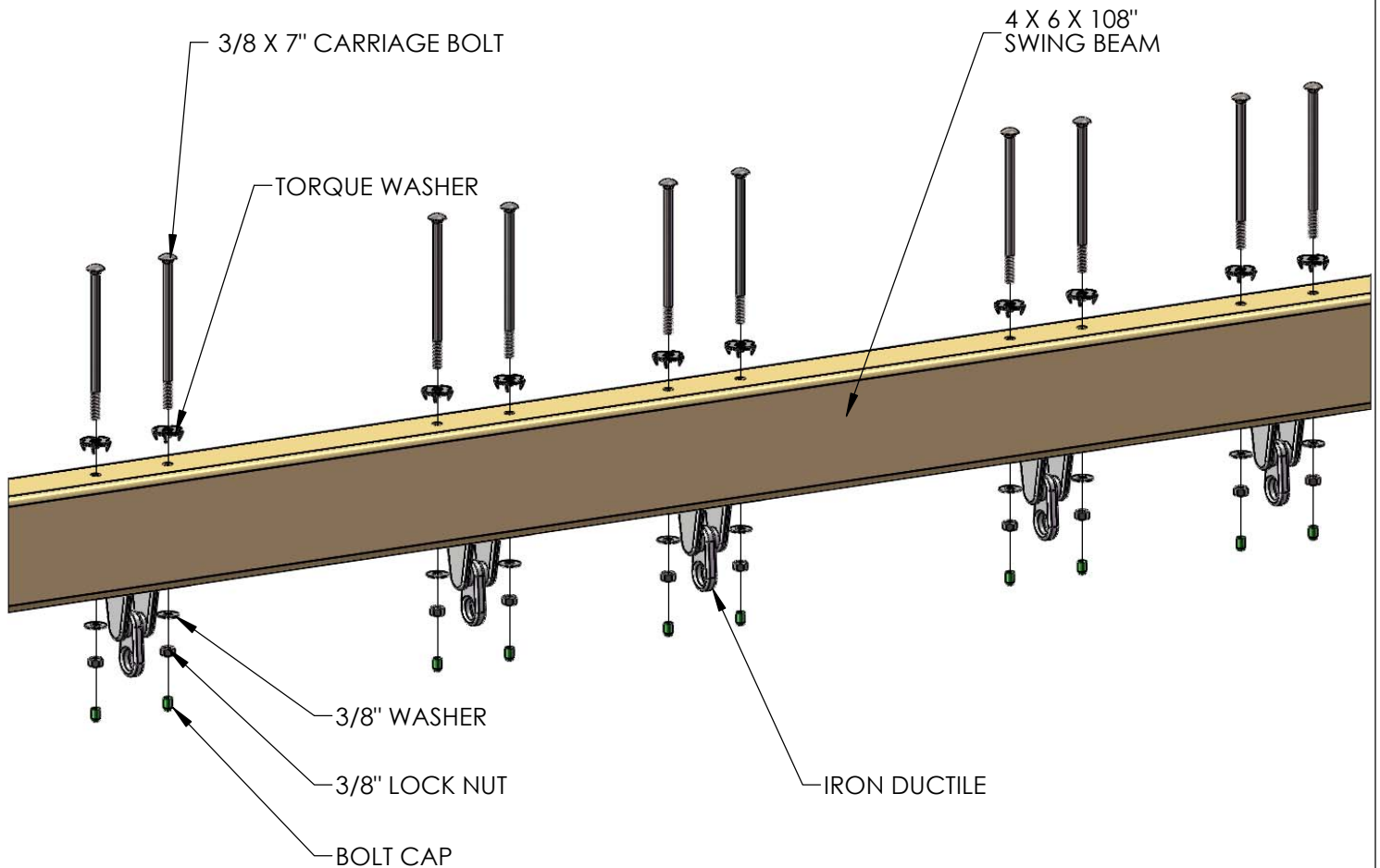

STEP 25: ATTACH SWING LEGS TO BRACKET

1: PLACE THE 4 X 4 X 108" SWING LEGS FLUSH TO THE TOP OF THE SWING LEG BRACKET.

2: FASTEN THE SWING LEGS TO THE SWING LEG BRACKET WITH 3/8 X 3-1/2" LAG SCREWS AND 3/8" WASHERS.

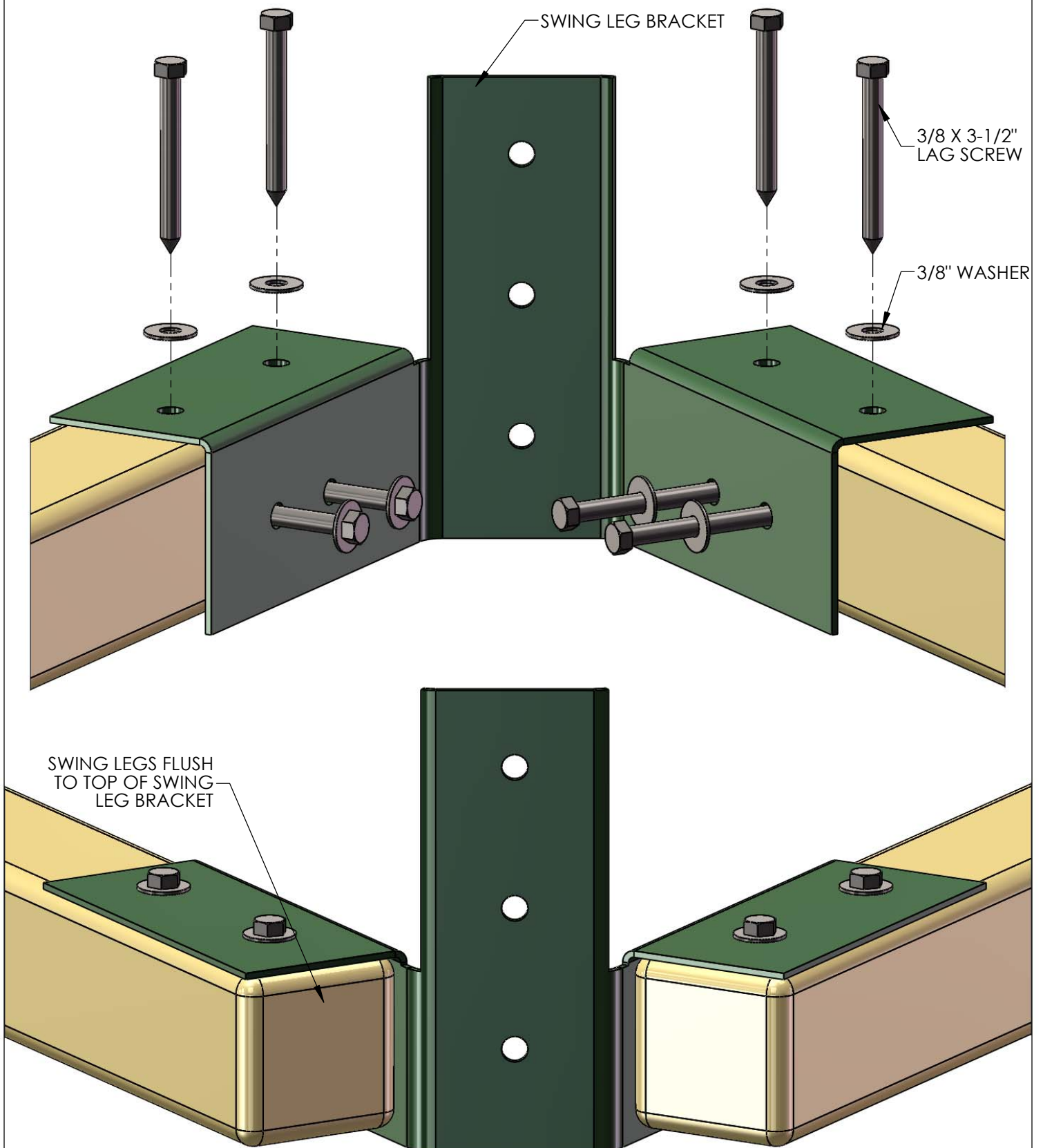

STEP 26: REST SWING BEAM ON FORT

*TWO PEOPLE ARE REQUIRED FOR THIS STEP

1: LAY THE SWING BEAM ACROSS THE FORT AND POSITION THE LEGS UNDERNEATH THE END OF THE BEAM.

2: LINE UP THE PRE-DRILLED HOLES AND REST THE SWING BEAM ON TOP OF THE SWING BEAM SUPPORT PLATE AND SWING LEGS. MAKE SURE THE IRON DUCTILES ARE FACING DOWN.



STEP 27: ATTACHING SWING BEAM TO SWING BEAM LEGS

- 1: FASTEN THE SWING BEAM TO THE SWING BEAM LEG BRACKET USING 7" CARRIAGE BOLTS WITH TORQUE WASHERS ON TOP OF THE SWING BEAM, AND 3/8" LOCK NUTS WITH 3/8" WASHERS UNDERNEATH.
- 2: USE A 3/8 X 3-1/2" LAG SCREW AND 3/8" WASHER IN THE MIDDLE HOLE OF THE SWING LEG BRACKET.
- 3: PLACE BOLT CAPS OVER EXPOSED THREADS AFTER SECURING.

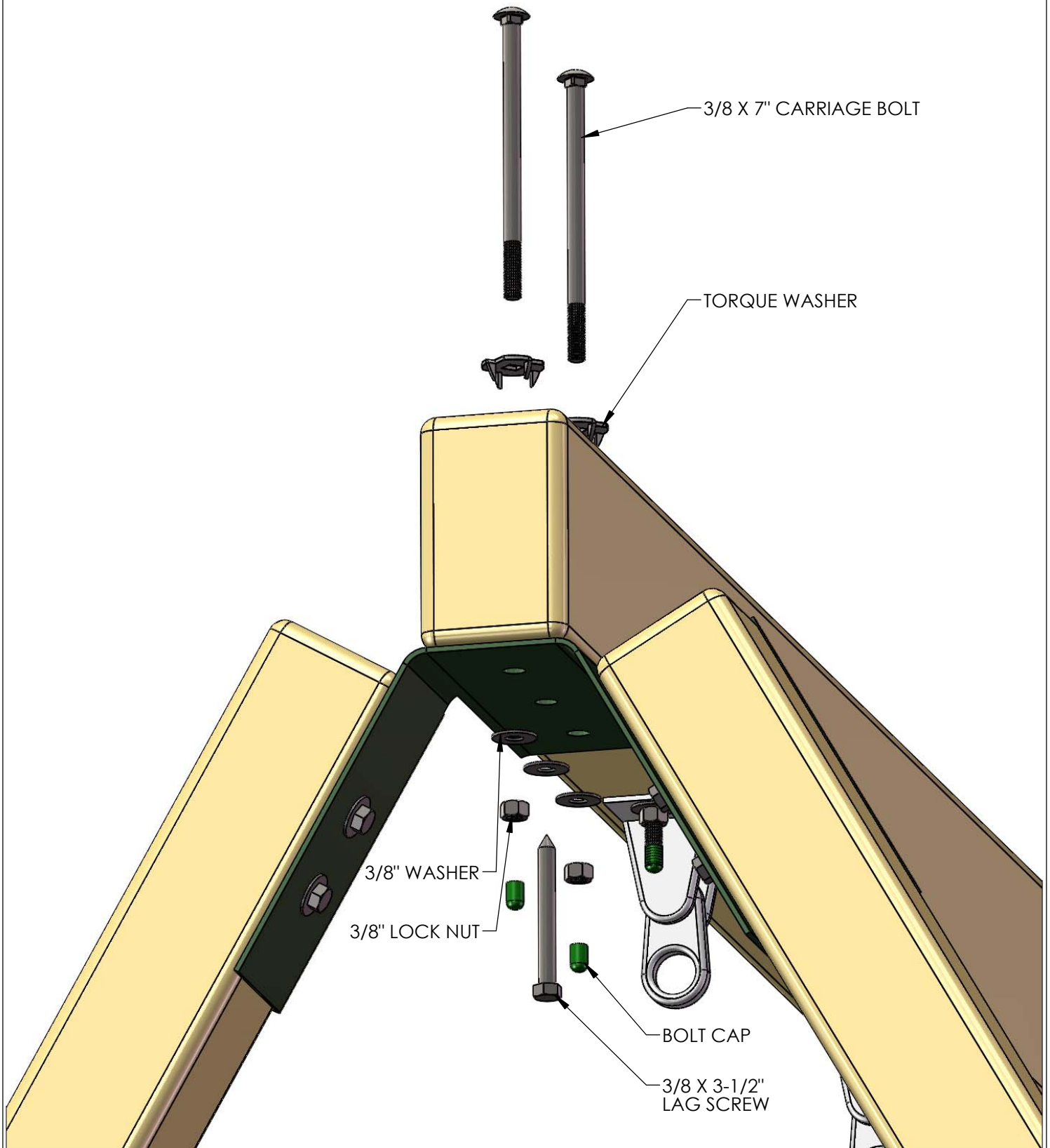

STEP 28: ATTACHING THE SWING BEAM TO THE FORT

*AN EXTRA PERSON IS REQUIRED FOR THIS STEP

- 1: AFTER THE LEGS ARE ATTACHED, HAVE ONE PERSON ON THE GROUND PICK UP THE SWING BEAM BY THE LEGS, AND ANOTHER PERSON PICK UP THE SWING BEAM FROM INSIDE THE FORT AND WALK OUT THE SWING BEAM.
- 2: LINE UP THE PILOT HOLE ON THE END OF THE SWING BEAM WITH THE MIDDLE HOLE ON THE SWING BEAM PLATE.
- 3: FASTEN THE SWING BEAM TO THE SWING BEAM PLATE AND SWING BEAM SUPPORT USING A 9" CARRIAGE BOLT WITH A TORQUE WASHER ON TOP AND A 3/8" LOCK NUT AND WASHER ON THE BOTTOM. PLACE A GREEN BOLT CAP OVER EXPOSED THREADS AFTER SECURING.
- 4: FASTEN THE SWING BEAM TO THE SWING BEAM PLATE FROM UNDERNEATH WITH A 3/8 X 3-1/2" LAG SCREW AND A 3/8" WASHER.

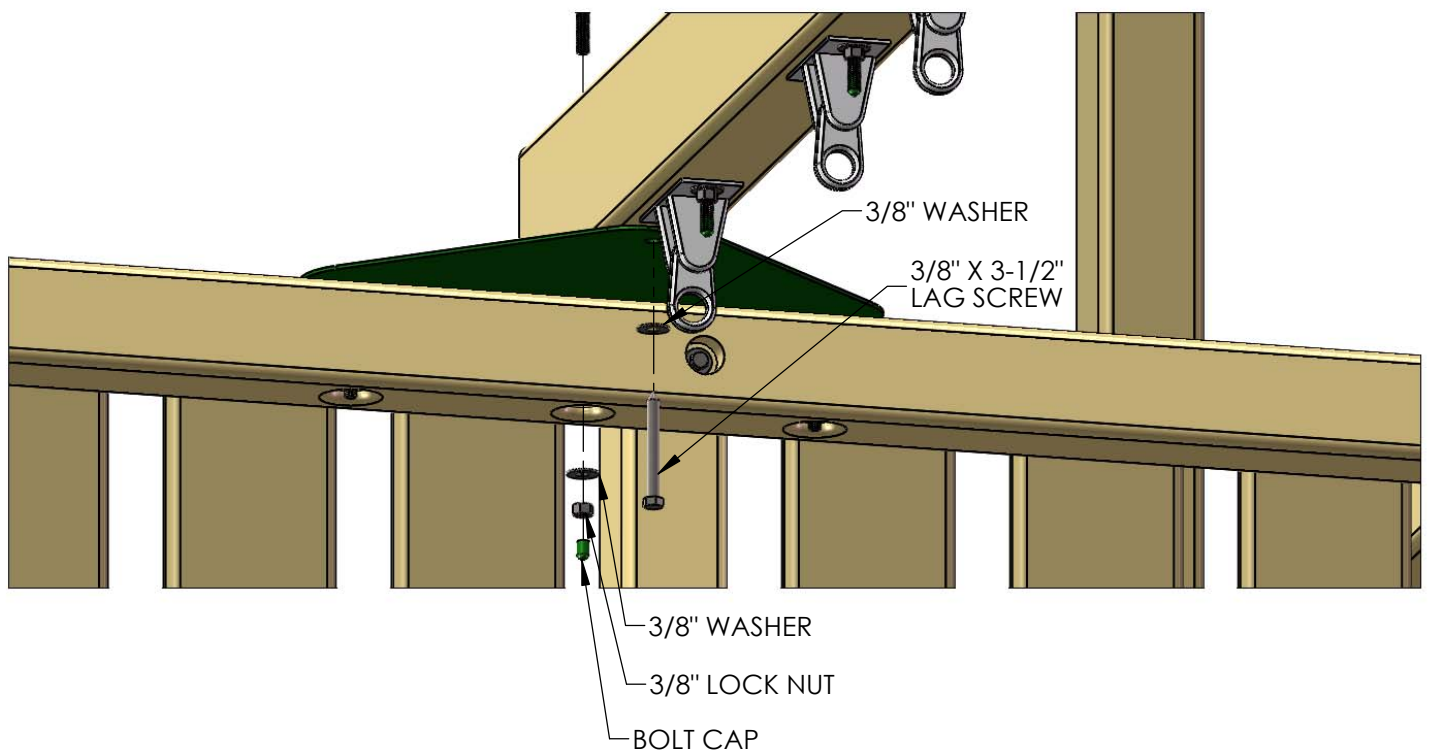
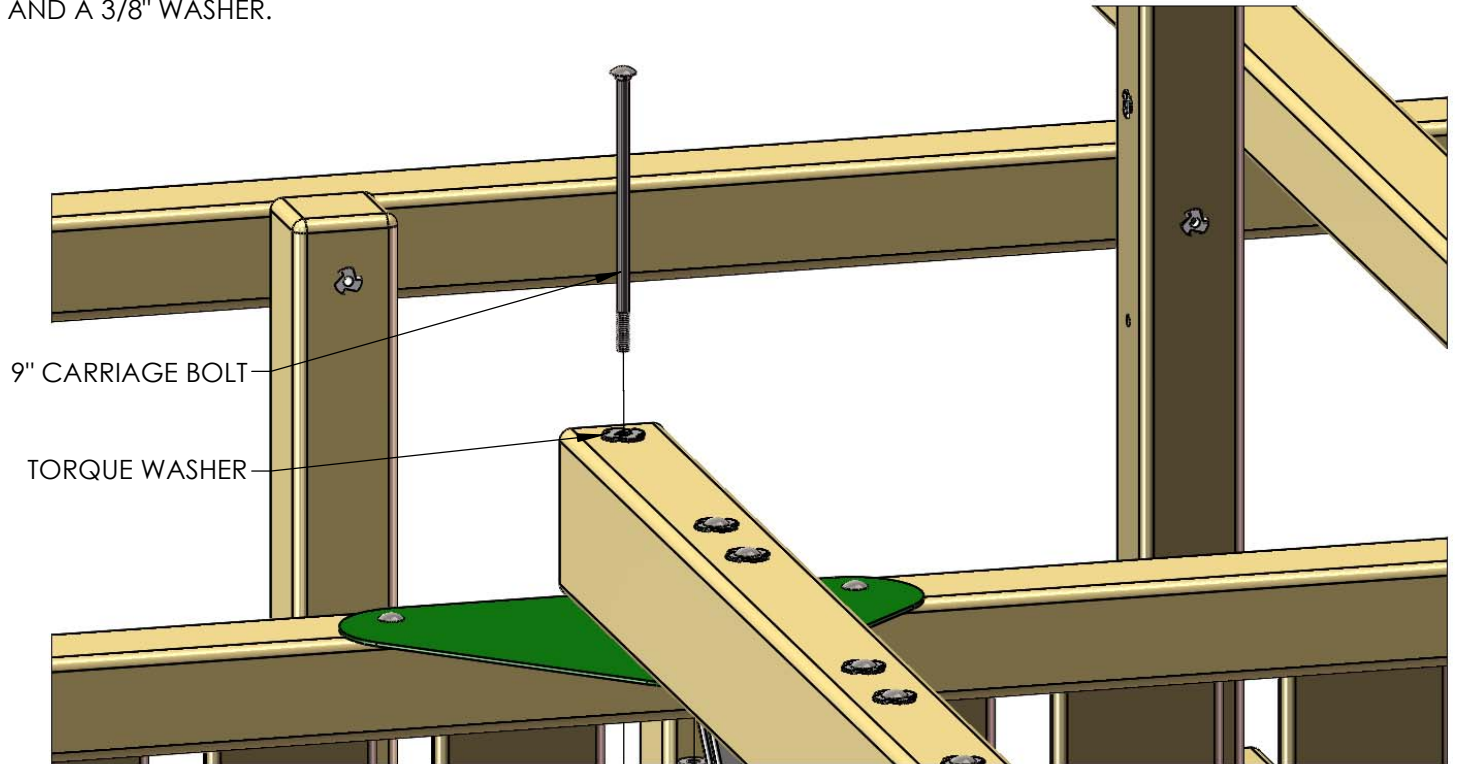

STEP 29: LEVEL THE SWING BEAM

1: PLACE A LEVEL ON TOP OF THE SWING BEAM AND ADJUST THE LEGS IN OR OUT AS NEEDED TO MAKE THE SWING BEAM LEVEL.



STEP 30: SWING LEG CROSS-MEMBER

1: POSITION THE 2 X 4 X 70" SWING LEG CROSS-MEMBER AGAINST THE SWING BEAM LEGS.

2: LEVEL THE CROSS-MEMBER, AND FASTEN TO THE SWING LEGS WITH 3/8" X 3-1/2" LAG SCREWS AND 3/8" WASHERS.

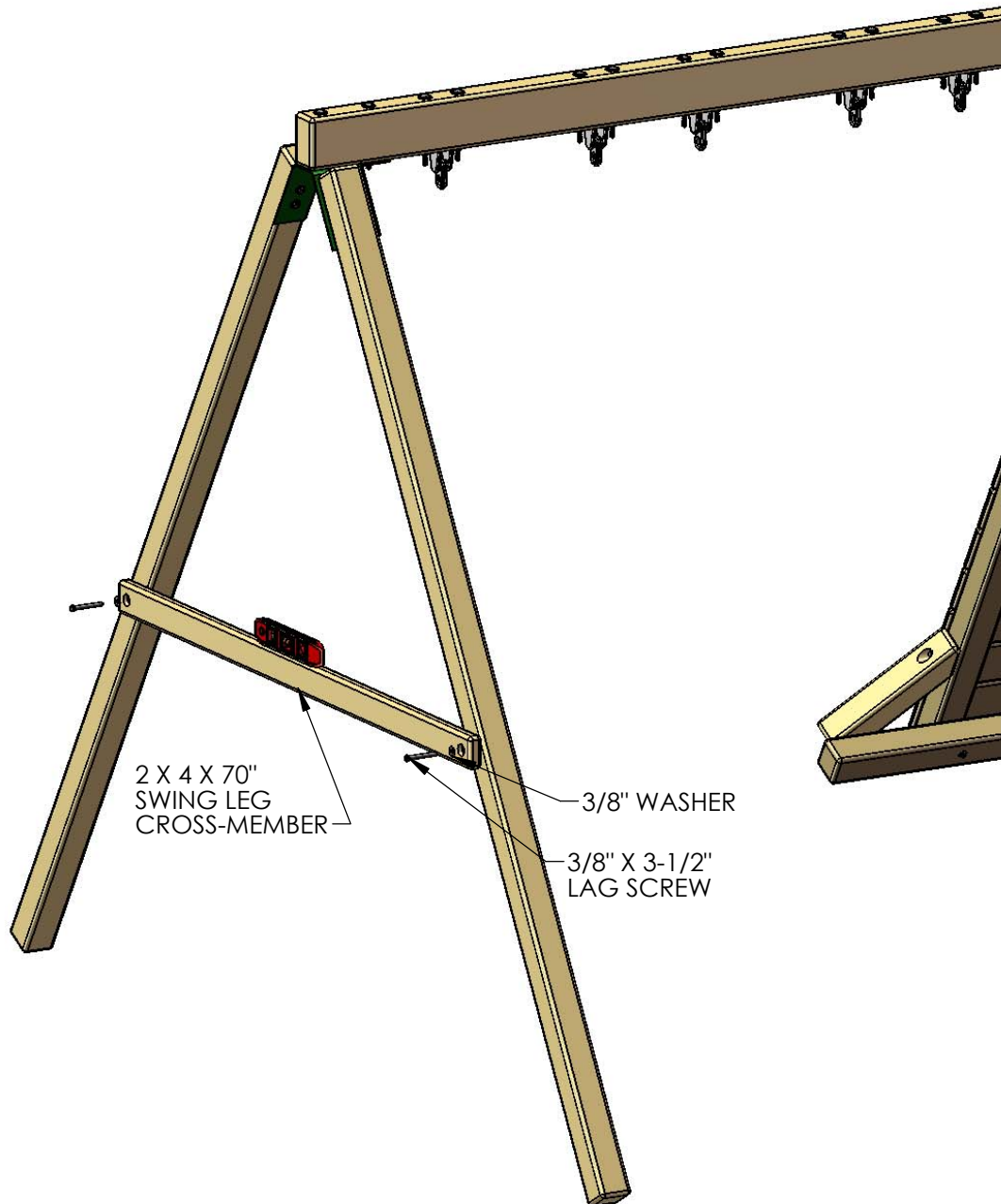

STEP 31: TIRE SWING

- 1: GO UNDER THE DECK. PLACE THE TIRE SWING SWIVEL ON THE TIRE SWING SUPPORT. CENTER THE TIRE SWING SWIVEL BELOW THE MIDDLE DECK BOARD.
- 2: MARK THE LOCATION OF THE HOLES IN THE SWIVEL WITH A PENCIL, AND WITH A 3/8" DRILL BIT, DRILL HOLES THROUGH THE TIRE SWING SUPPORT AND MIDDLE DECK BOARD.
- 3: USE A 5-1/2" CARRIAGE BOLT TO CLEAR OUT ANY DEBRIS LEFT OVER FROM DRILLING, MATE WITH A TORQUE WASHER AND SET THE TORQUE WASHER ON TOP OF THE MIDDLE DECK BOARD WITH A HAMMER.
- 4: PLACE THE TIRE SWIVEL ON THE TWO CARRIAGE BOLTS, AND FASTEN WITH 3/8" LOCK NUTS WITH 3/8" WASHERS. COVER ANY EXPOSED THREADS WITH BOLT CAPS.

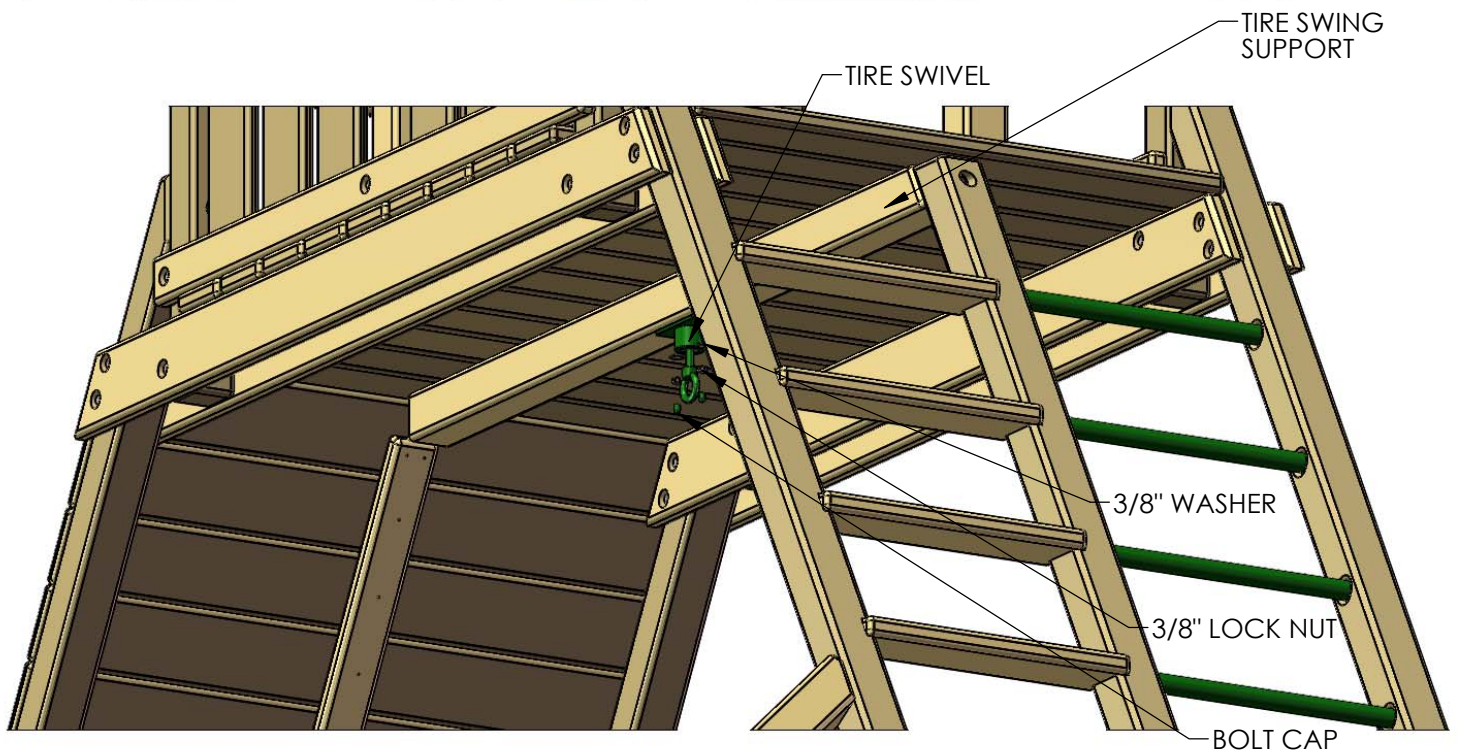
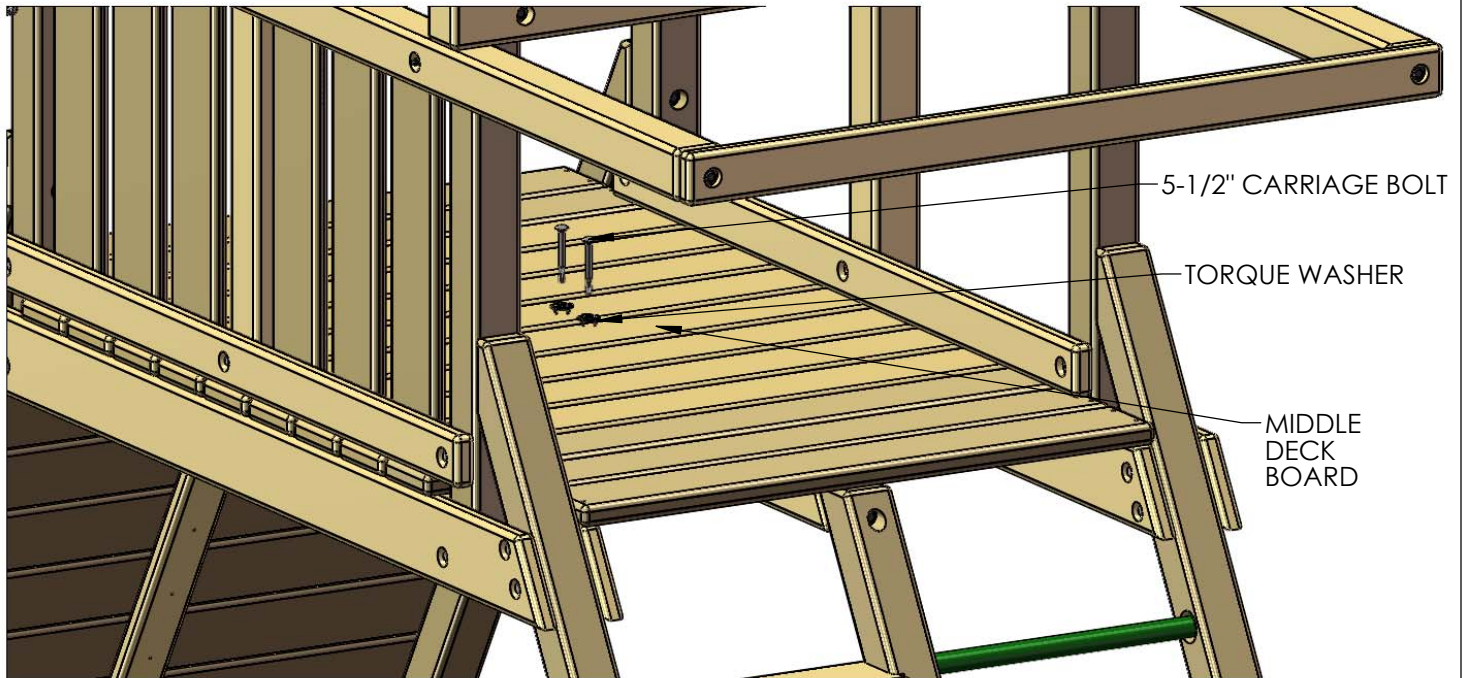

STEP 32: INSTALLING THE ROCKS

1: THE ROCKS SHOULD FOLLOW THE GENERAL STAGGERED LAYOUT SHOWN BELOW. HOWEVER, A DIFFERENT CONFIGURATION CAN BE USED.

2: THE ROCKS INCLUDED IN YOUR PLAYSET MAY VARY, IN ANY CASE, THE 1-1/4" PAN HEAD SCREWS WITH WASHERS WILL BE USED TO ATTACH THE ROCKS.

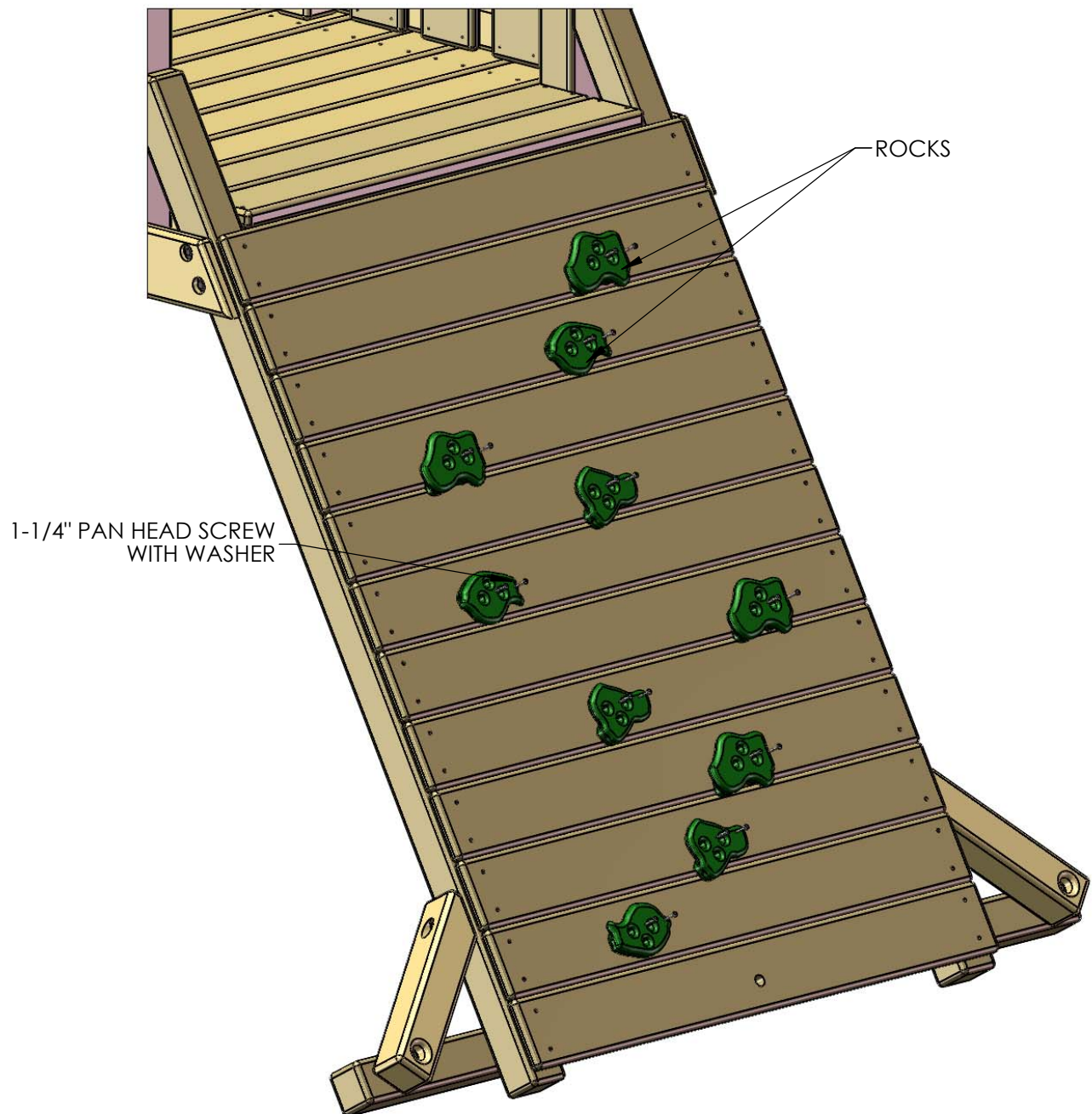

STEP 33: CLIMBING ROPE

1: THREAD ONE END OF THE ROPE THROUGH THE HOLE ABOVE THE ROCK WALL. TIE A SECURE KNOT ON THE INSIDE OF THE TOP PANEL BOARD. ADD KNOTS IN ROPE TO AID IN CLIMBING. SET KNOTS ACCORDING TO YOUR CHILD'S NEEDS. 2-3 KNOTS SHOULD BE SUFFICIENT.

2: THREAD THE OTHER END OF THE ROPE THROUGH THE HOLE IN THE BOTTOM ROCK WALL BOARD. PULL THE ROPE TIGHT AND TIE A SECURE KNOT BEHIND THE BOTTOM ROCK WALL BOARD.

3: WRAP ROPE AROUND YOUR HAND TO TEST FOR LOOSENESS AS DESCRIBED BELOW.

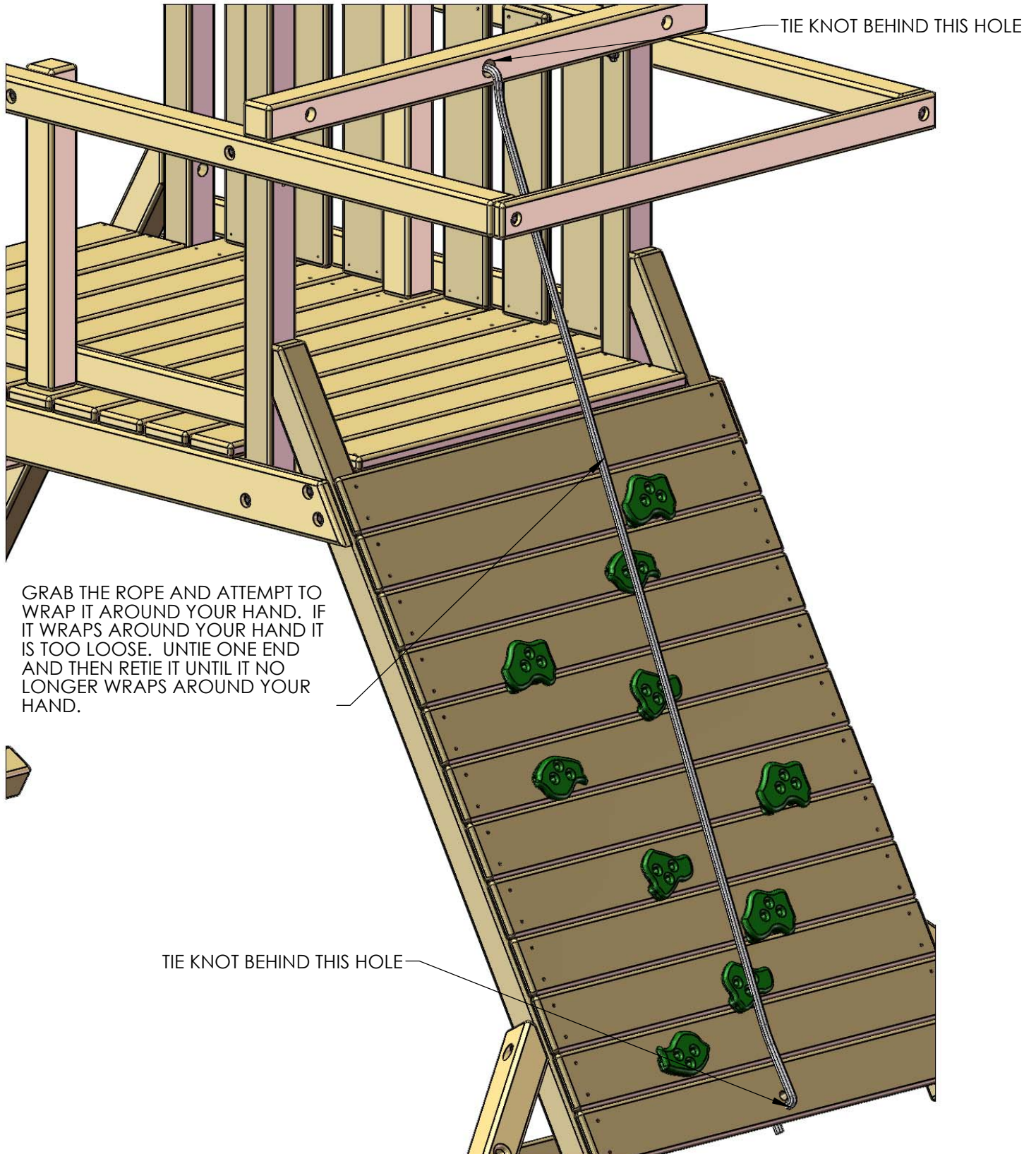

STEP 34: ROPE LADDER ASSEMBLY

- 1: FIND THE THREE ROPE LADDER ROPES OF EQUAL LENGTH. MEASURE 30" FROM ONE SIDE OF EACH PIECE OF ROPE AND MAKE A MARK AT THIS LOCATION.
- 2: TIE A KNOT ON THE OTHER SIDE OF THE ROPE THAT IS JUST ABOVE THE MARK THAT WAS MADE ON THE ROPE (SEE BELOW).
- 3: THREAD THE ROPE THROUGH THE HOLES OF THE 2 X 4 ROPE LADDER RUNG. YOU MAY NEED TO TWIST THE ROPE TO GET IT THROUGH.

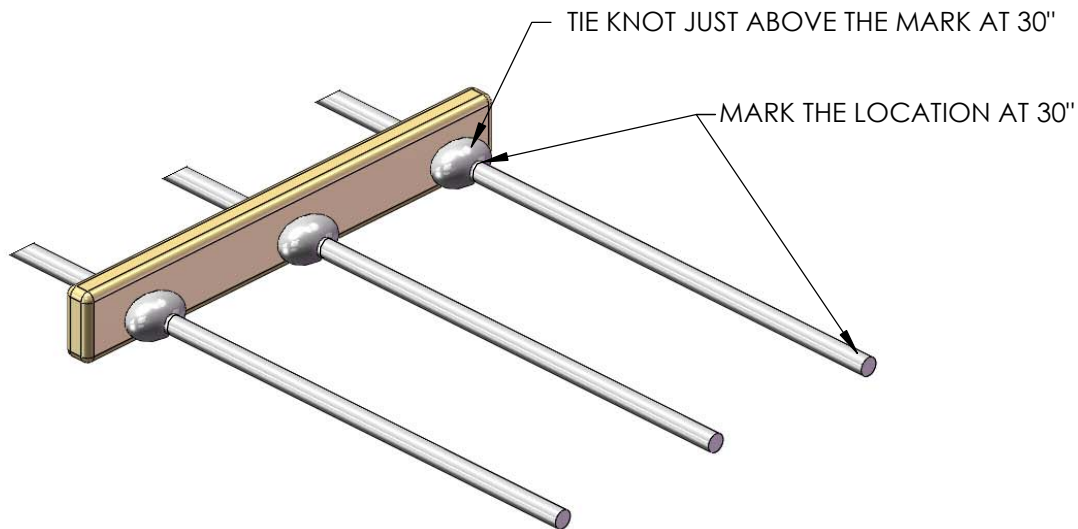

4: MEASURE 19" FROM THE TOP OF THE ROPE LADDER RUNG ON THE ROPE AND MARK THIS LOCATION. MAKE SURE THE BOARD IS RESTING AGAINST THE PREVIOUS KNOT THAT WAS TIED WHEN MEASURING.

5: TIE A KNOT BELOW THE MARK THAT WAS MADE AND THREAD THE ROPE THROUGH THE HOLES IN THE NEXT ROPE LADDER RUNG. THERE SHOULD BE APPROXIMATELY A 10" GAP BETWEEN THE BOARDS.

6: CONTINUE THIS PROCESS UP THE ROPE, AND WHEN THE LAST BOARD HAS BEEN PLACED, TIE A KNOT DIRECTLY ABOVE IT. THE LAST BOARD TIED WILL BE THE TOP OF THE ROPE LADDER.

AFTER THE LAST BOARD IS PLACED ON THE ROPE LADDER ASSEMBLY, TIE A KNOT DIRECTLY ABOVE THE LAST BOARD

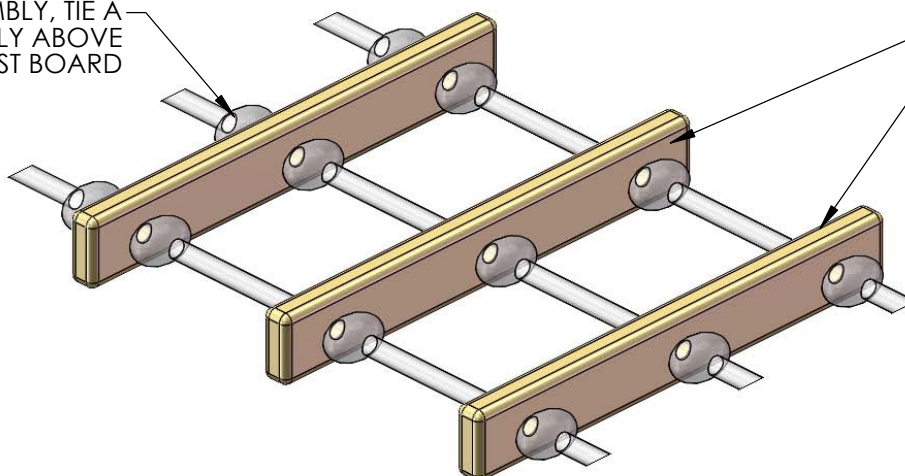

STEP 35: INSTALLING THE ROPE LADDER

- 1: UNROLL THE ROPE LADDER ASSEMBLY. LOOK FOR THE BOARD THAT HAS KNOTS TIED ABOVE AND BELOW THE ROPE LADDER STEP. THIS WILL BE THE TOP OF THE ROPE LADDER.
- 2: THREAD THE TOP OF THE ROPE LADDER THROUGH THE HOLES IN THE ROPE LADDER SUPPORT, AND TIE A SECURE KNOT.
- 3: THREAD THE BOTTOM OF THE ROPE LADDER THROUGH THE HOLES IN THE ROPE LADDER RUNNER, AND TIE A SECURE KNOT.
- 4: MAKE SURE THE ROPE LADDER ROPES WILL NOT LOOP AROUND YOUR HAND.

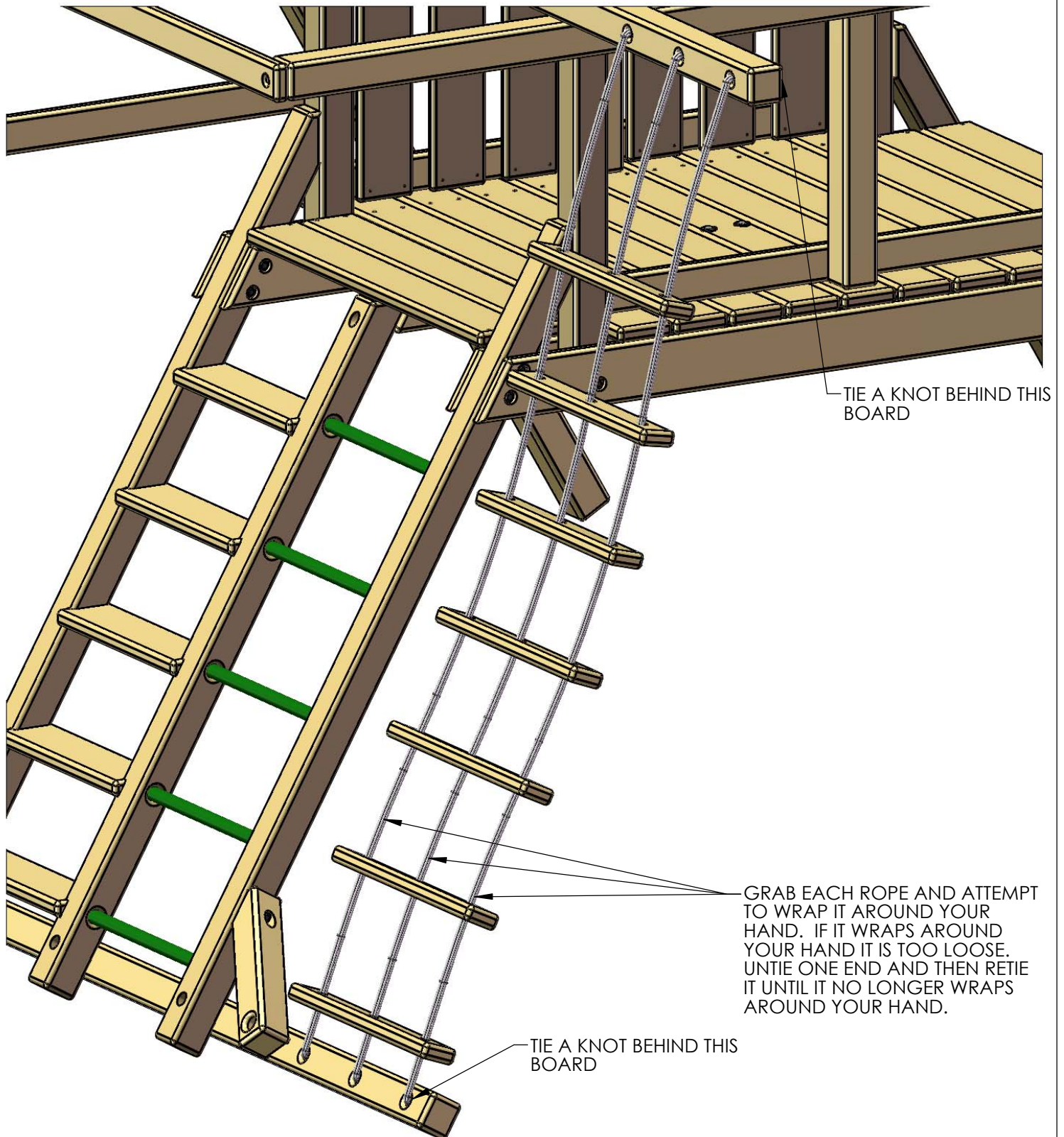

STEP 36: ROOF COMPONENTS

1: USING A 1/8" DRILL BIT, DRILL HOLES IN THE ROOF COMPONENTS TO THE DIMENSIONS SHOWN BELOW.

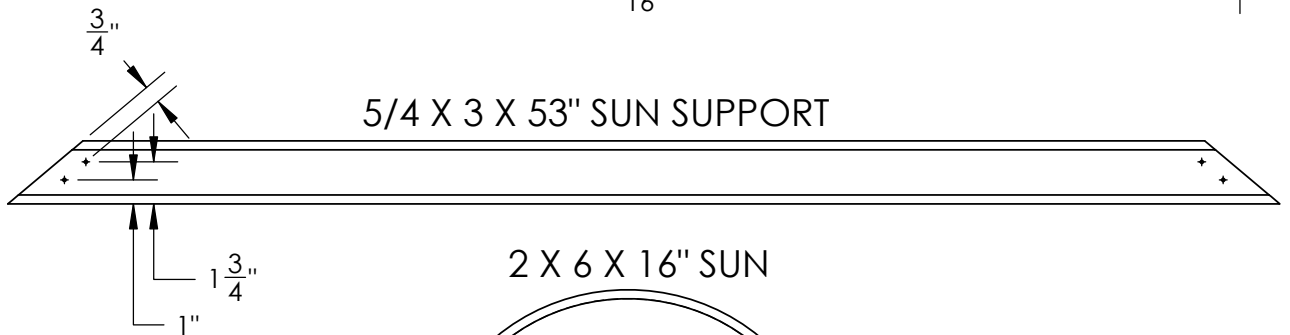
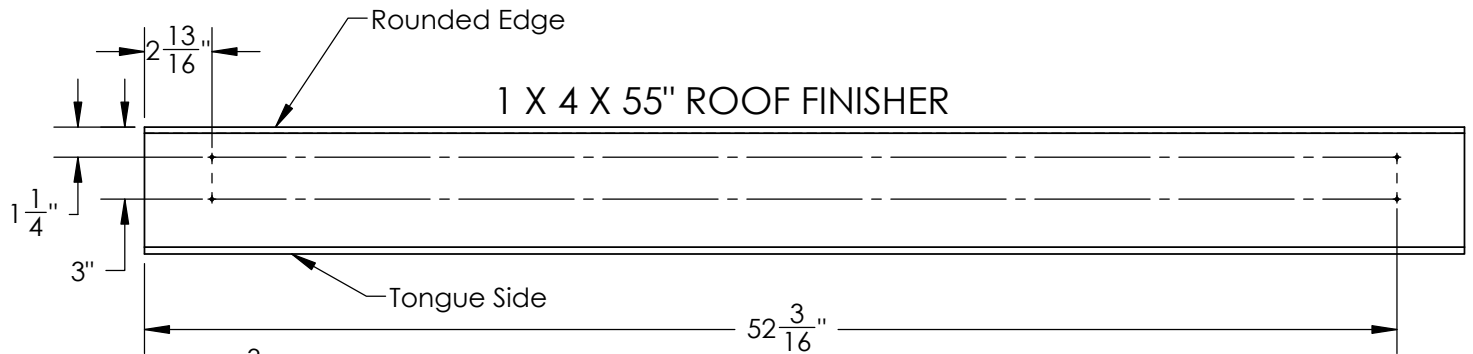
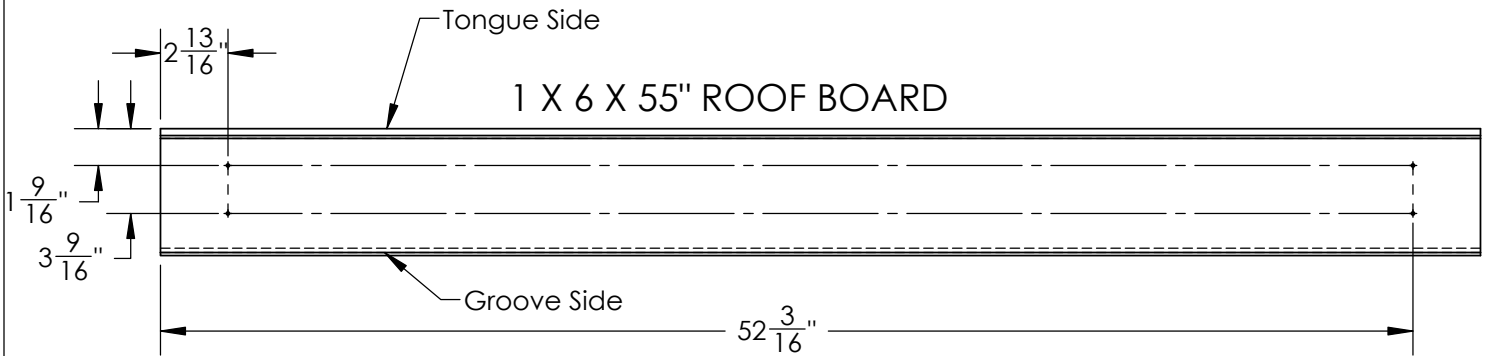
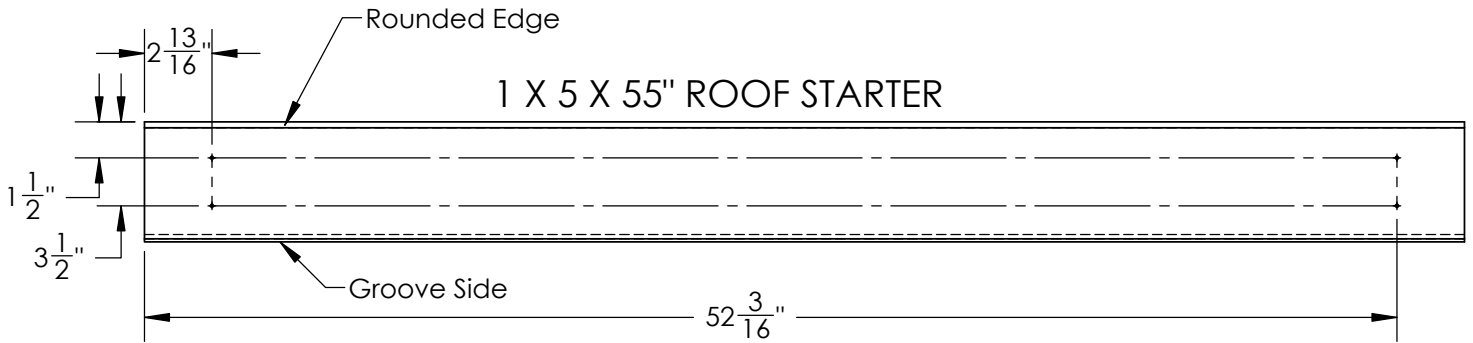

Note: For top hole of the Large Ray slant your drill to the right when drilling the hole.

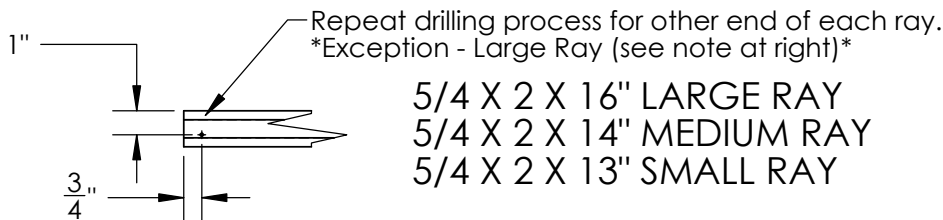

STEP 37: ROOF PEAK

1: PLACE THE 55" ROOF PEAK ON TOP OF THE ROOF STARTER BOARDS.

2: FASTEN THE ROOF PEAK TO THE ROOF STARTER BOARDS WITH WOOD SCREWS.

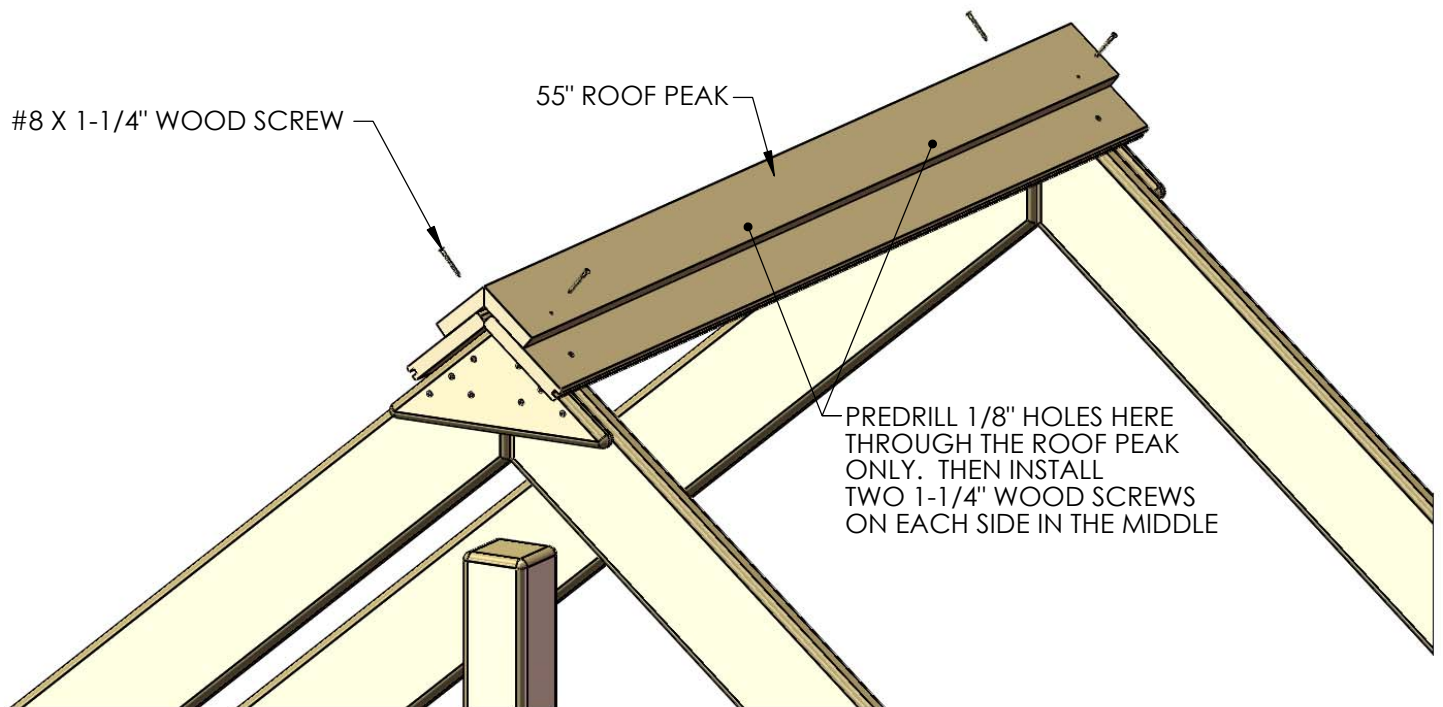

STEP 38: ROOF

1: PLACE THE 1 X 6 X 55" ROOF BOARDS ON TOP OF THE ROOF SUPPORTS, FITTING THE TONGUE END INTO THE GROOVE END OF THE ROOF STARTERS. EACH SIDE OF THE ROOF GETS FOURTEEN ROOF BOARDS. THE HOLES IN THE ROOF BOARDS SHOULD BE CENTERED OVER THE ROOF SUPPORTS. IF NECESSARY PLACE A SCRAP 2 X 4 BOARD AGAINST THE ROOF BOARD AND HAMMER ON IT TO SEAT THE TONGUE INTO THE GROOVE FOR THE ROOF BOARDS.

2: FASTEN THE ROOF BOARDS TO THE ROOF SUPPORTS WITH 1-1/2" WOOD SCREWS.

3: PLACE A 1 X 4 X 55" ROOF FINISHER AT THE END OF THE ROOF ASSEMBLY, AND FASTEN WITH 1-1/2" WOOD SCREWS.

TIP: USE THE INSTRUCTIONS PROVIDED IN THE APENDIX TO BUILD THE CHIMNEY AND DORMERS TO BUILD THEM. INSTALL FOUR ROOF BOARDS AND THEN INSTALL THE CHIMNEY ACCORDING TO THE CHIMNEY INSTRUCTIONS. AFTER INSTALLING THE NINTH ROOF BOARD INSTALL THE DORMER ACCORDING TO THE DORMER INSTRUCTIONS. THEN FINISH INSTALLING THE REMAINING ROOF BOARDS AND ROOF FINISHER. ALSO NOTE THAT THERE IS ONE DORMER ON EACH SIDE OF THE ROOF.

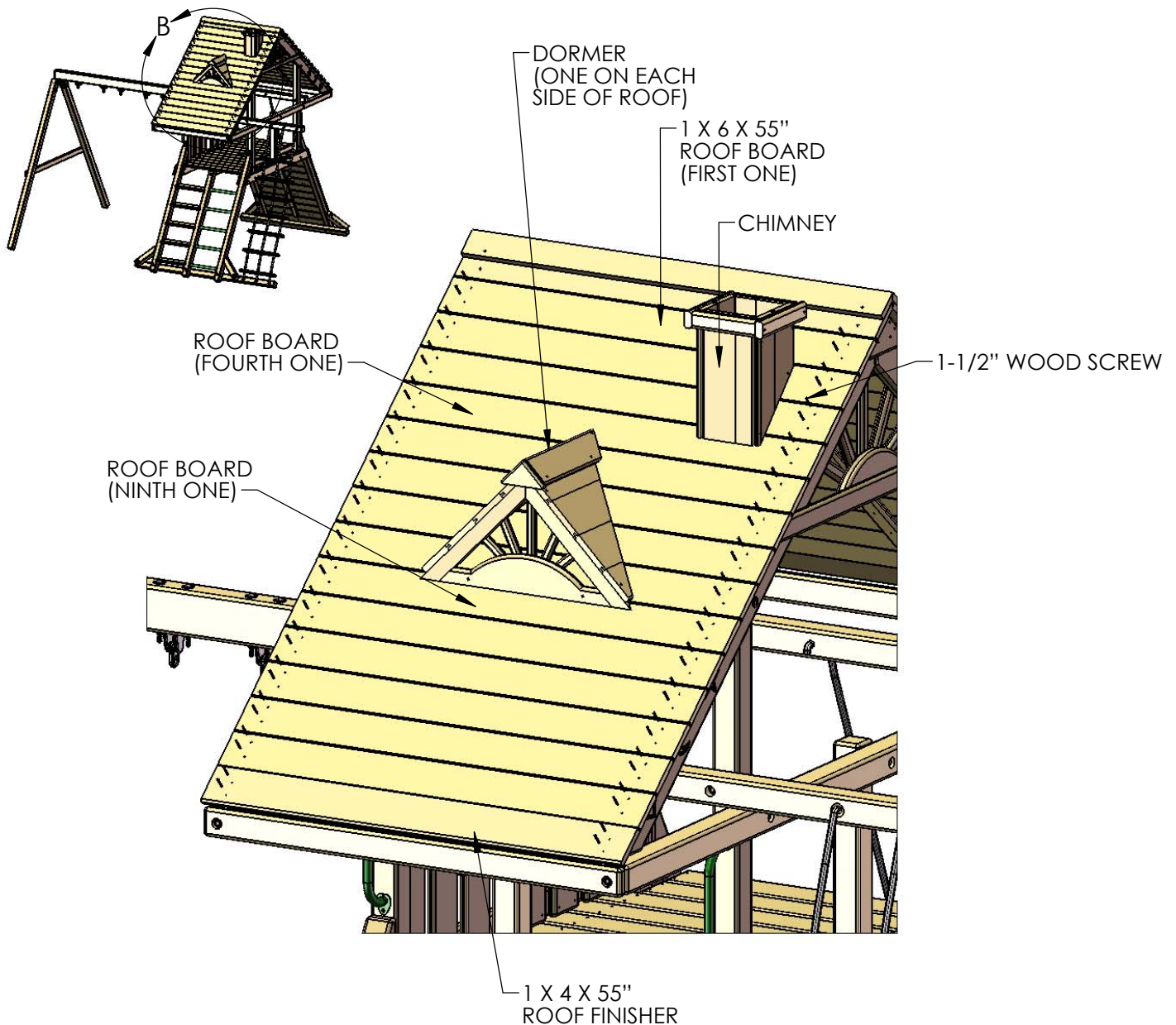

STEP 39: SUNBURST

1: PLACE THE 2 X 6 X 16" SUN CENTERED AGAINST THE 5/4 X 3 X 53" SUN SUPPORT. FASTEN THE SUN TO THE SUN SUPPORT WITH 2" WOOD SCREWS. REPEAT THIS PROCESS FOR THE OTHER SIDE OF THE FORT.

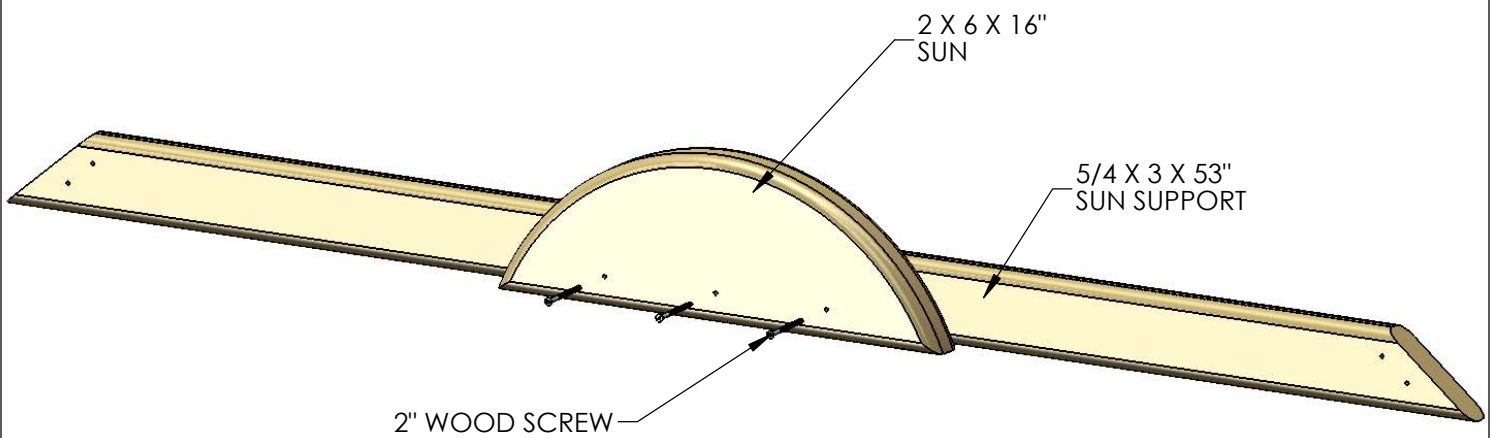

STEP 40: SUNBURST

1: PLACE THE ASSEMBLY MADE IN A PRIOR STEP UNDERNEATH THE ROOF BOARDS, AND AGAINST THE ANGLED ROOF SUPPORTS. MAKE SURE THE ASSEMBLY IS LEVEL BEFORE PROCEEDING TO THE NEXT STEP.

2: FASTEN THE SUN ASSEMBLY TO THE FORT WITH 2" WOOD SCREWS FROM THE OUTSIDE INTO THE ROOF SUPPORTS.

3: REPEAT ON THE OPPOSITE SIDE OF THE FORT.

NOTE: ROOF BOARDS AND OTHER DETAILS OMITTED FOR CLARITY.

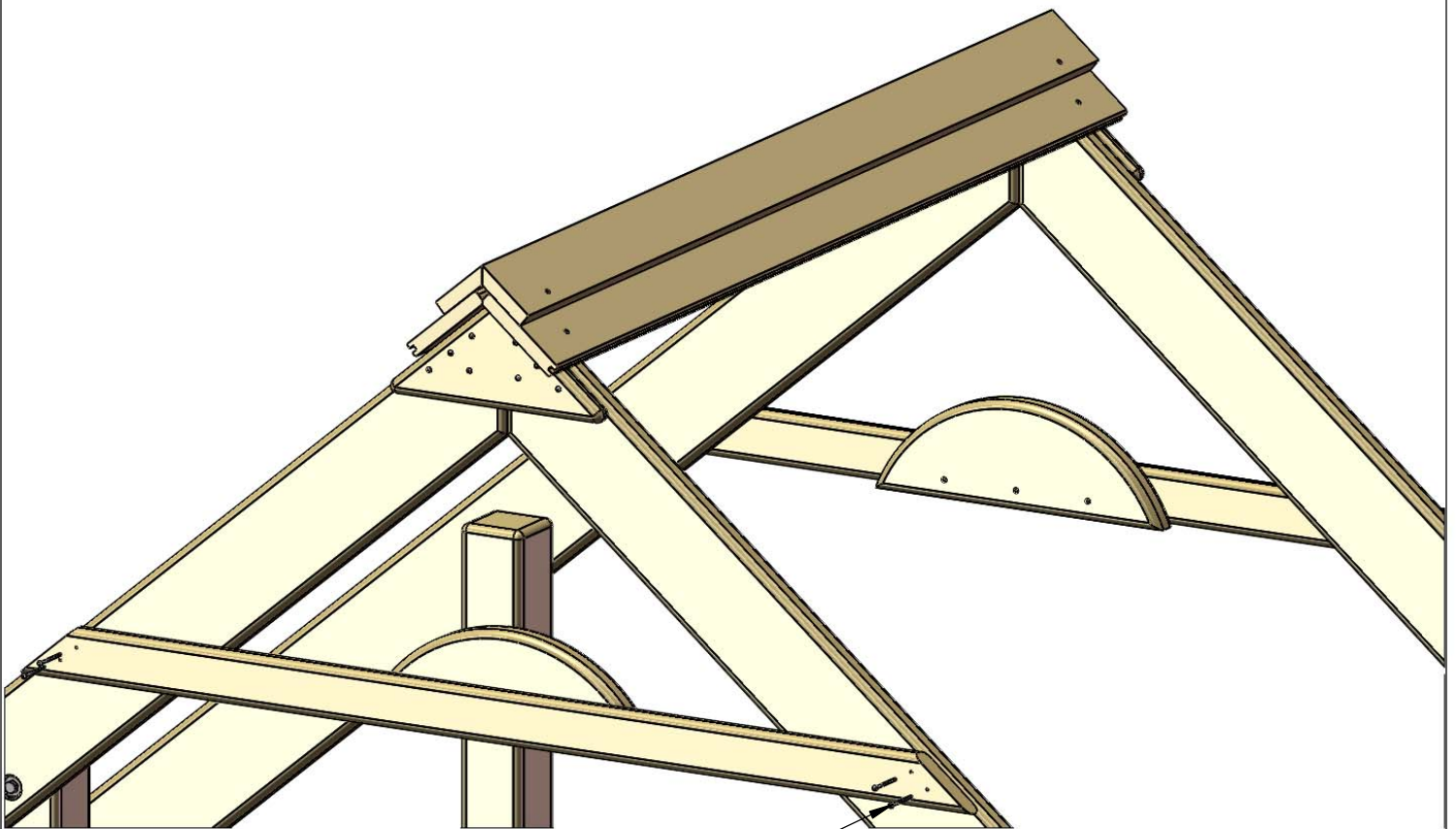

2" WOOD SCREW

STEP 41: SUNBURST

1: CENTER THE 5/4 X 2 X 17" LARGE RAY ONTO THE HALF SUN AND THE ROOF SUPPORT BOARDS. IF YOU HAVE A 703N ROOF KIT THEN THE HOLES IN THE LARGE RAY ARE PRE-DRILLED AND ARE OFFSET TO THE SIDE ON EACH END. PROCEED TO SUBSTEP 2 IF YOU HAVE THESE.

2: FASTEN THE LARGE RAY WITH TWO SCREWS.

3: EQUALLY SPACE THE SMALL AND MEDIUM RAYS ABOUT THE HALF SUN TO THE PATTERN SHOWN BELOW AND MARK THE POSITION OF EACH WITH A PENCIL.

4: SECURE THE SMALL AND MEDIUM SUNRAYS ONE AT A TIME TO THE HALF SUN AND THE ROOF SUPPORTS AND LINE THEM UP WITH THE MARK DRAWN. FASTEN THE SUNRAYS WITH TWO WOOD SCREWS EACH.

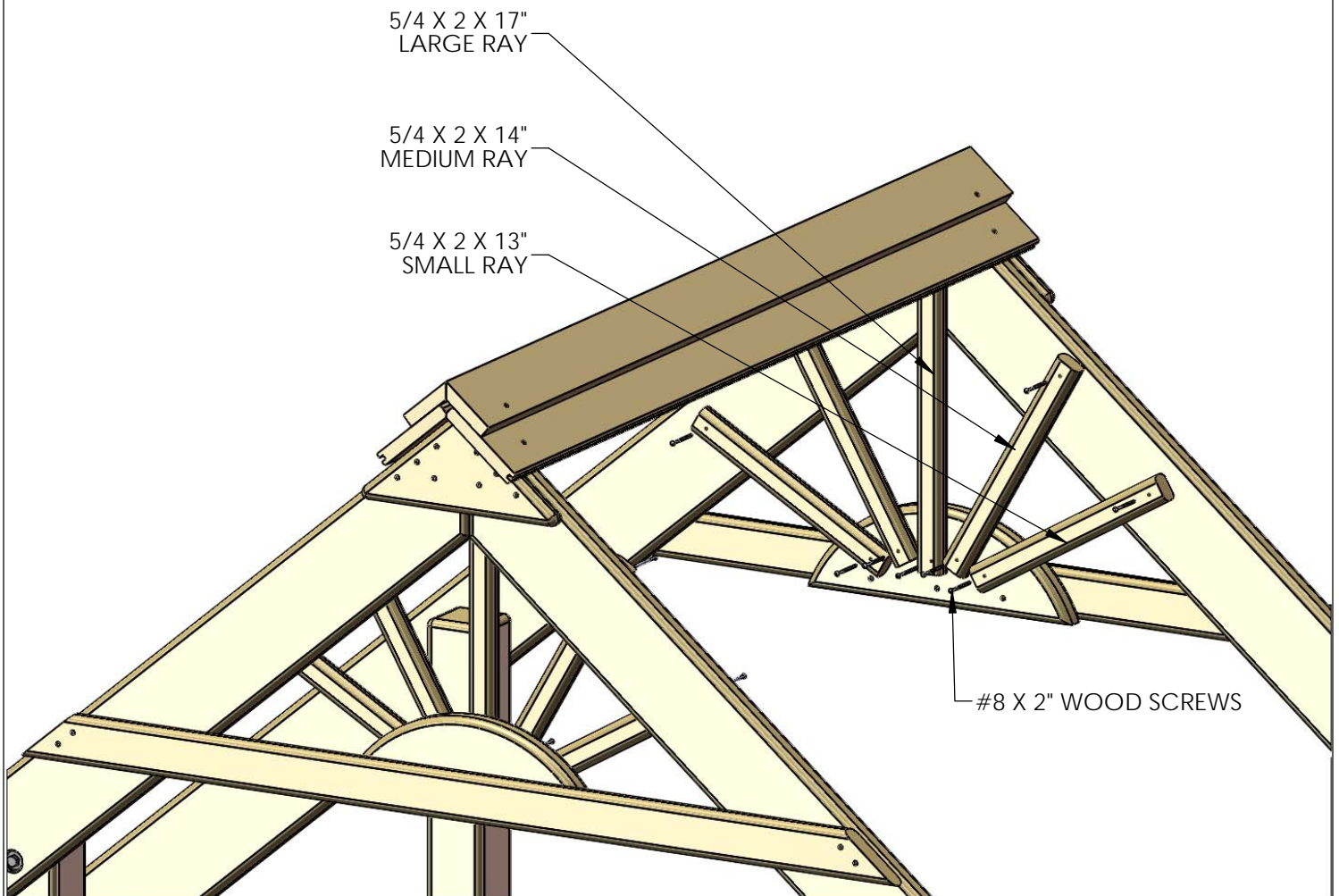

NOTE: ROOF BOARDS AND OTHER DETAILS OMITTED FOR CLARITY.

STEP 42: ROOF STRINGERS

1: PLACE 5/4 X 3 X 78" ROOF STRINGER AGAINST THE UNDERSIDE OF THE ROOF BOARDS IN THE CENTER.

2: ATTACH ROOF STRINGER TO ROOF BOARDS WITH ONE #8 X 1-1/2" WOOD SCREW PER ROOF BOARD.

3: REPEAT FOR OTHER SIDE OF ROOF.

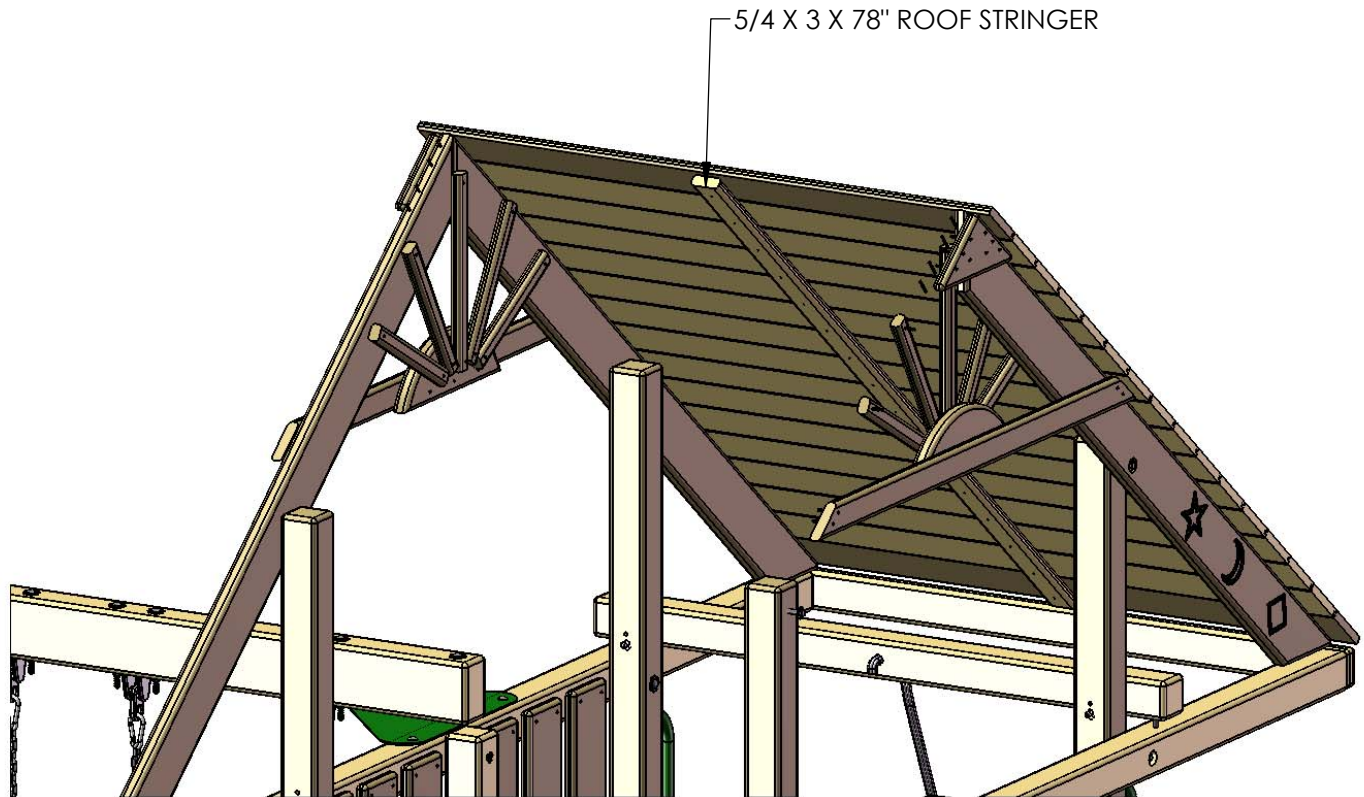

STEP 43: STEERING WHEEL

1: PLACE THE STEERING WHEEL INSERT INSIDE THE STEERING WHEEL.

2: USE THE HARDWARE INCLUDED WITH THE STEERING WHEEL TO MOUNT THE STEERING WHEEL TO THE REAR CENTER POST ON THE SWING BEAM SIDE. DO NOT OVER-TIGHTEN THE LAG SCREW INTO THE STEERING WHEEL, OR IT WILL NOT TURN.

3: PLACE THE STEERING WHEEL CAP OVER THE CENTER OF THE STEERING WHEEL.

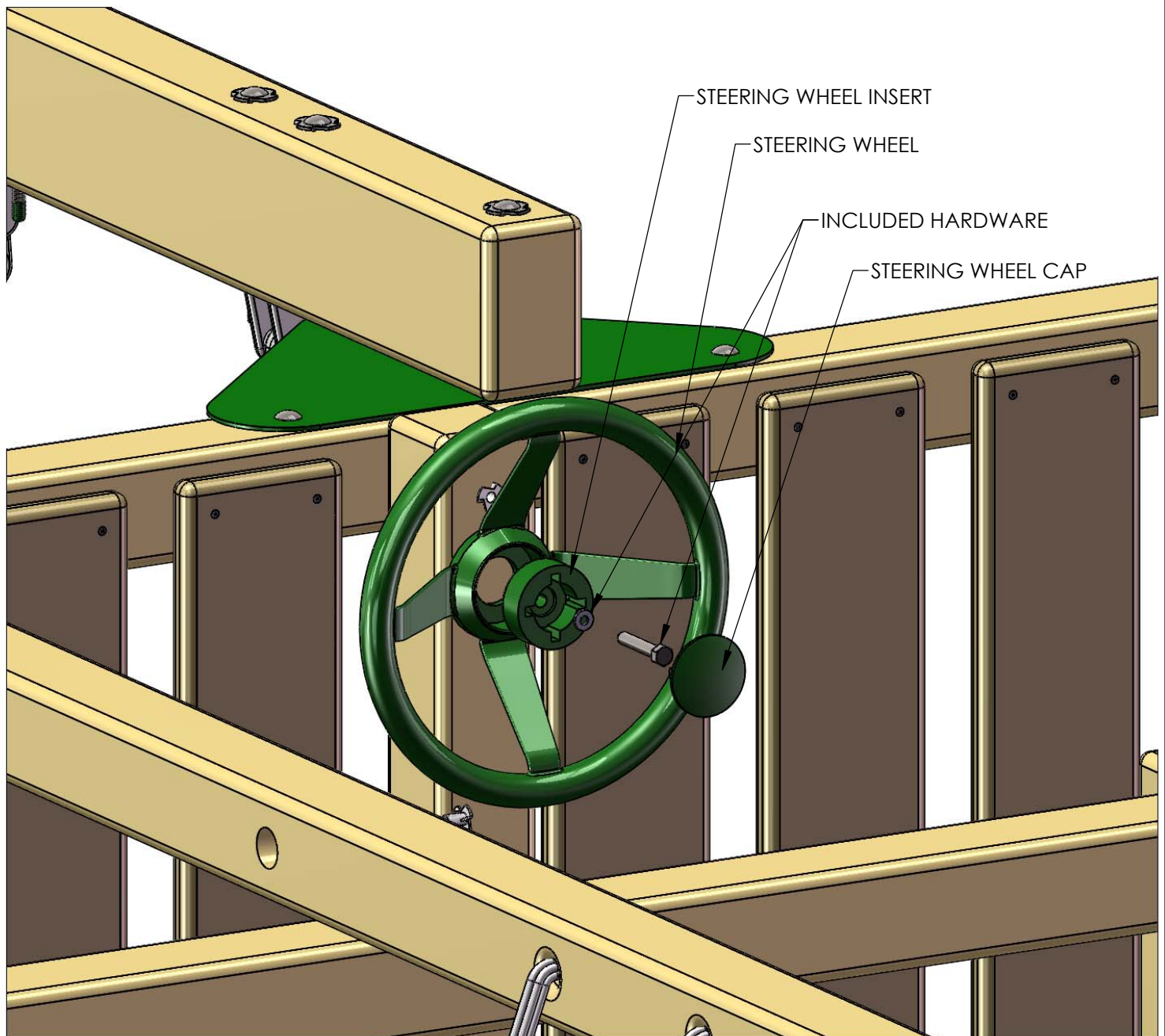

STEP 44: SAFETY HANDLES

- 1: FIND FOUR SAFETY HANDLES.
- 2: PLACE A SAFETY HANDLE JUST ABOVE THE ROCK WALL OPENING ON EACH SIDE, AND INSTALL WITH 1-1/4" PAN HEAD SCREWS AND WASHERS.
- 3: REPEAT THIS PROCESS FOR THE LADDER SIDE OF THE FORT.

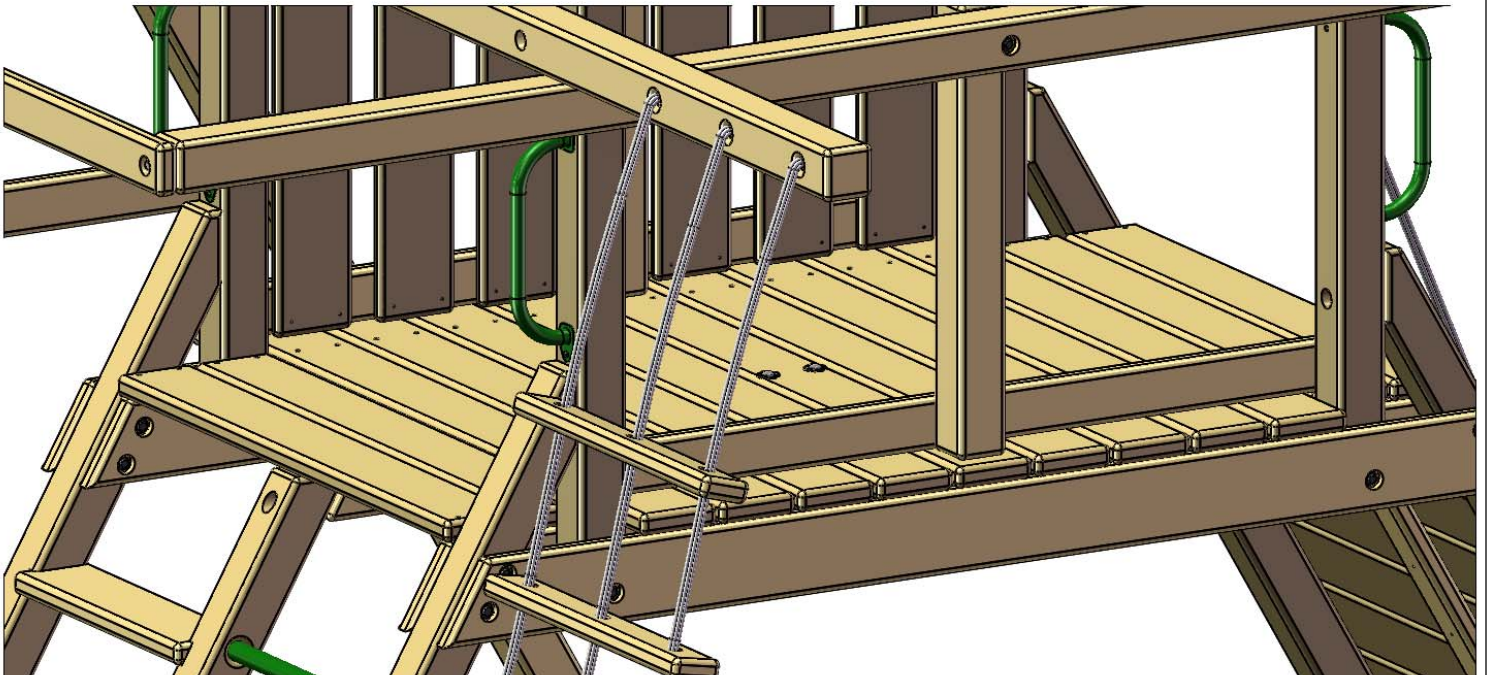
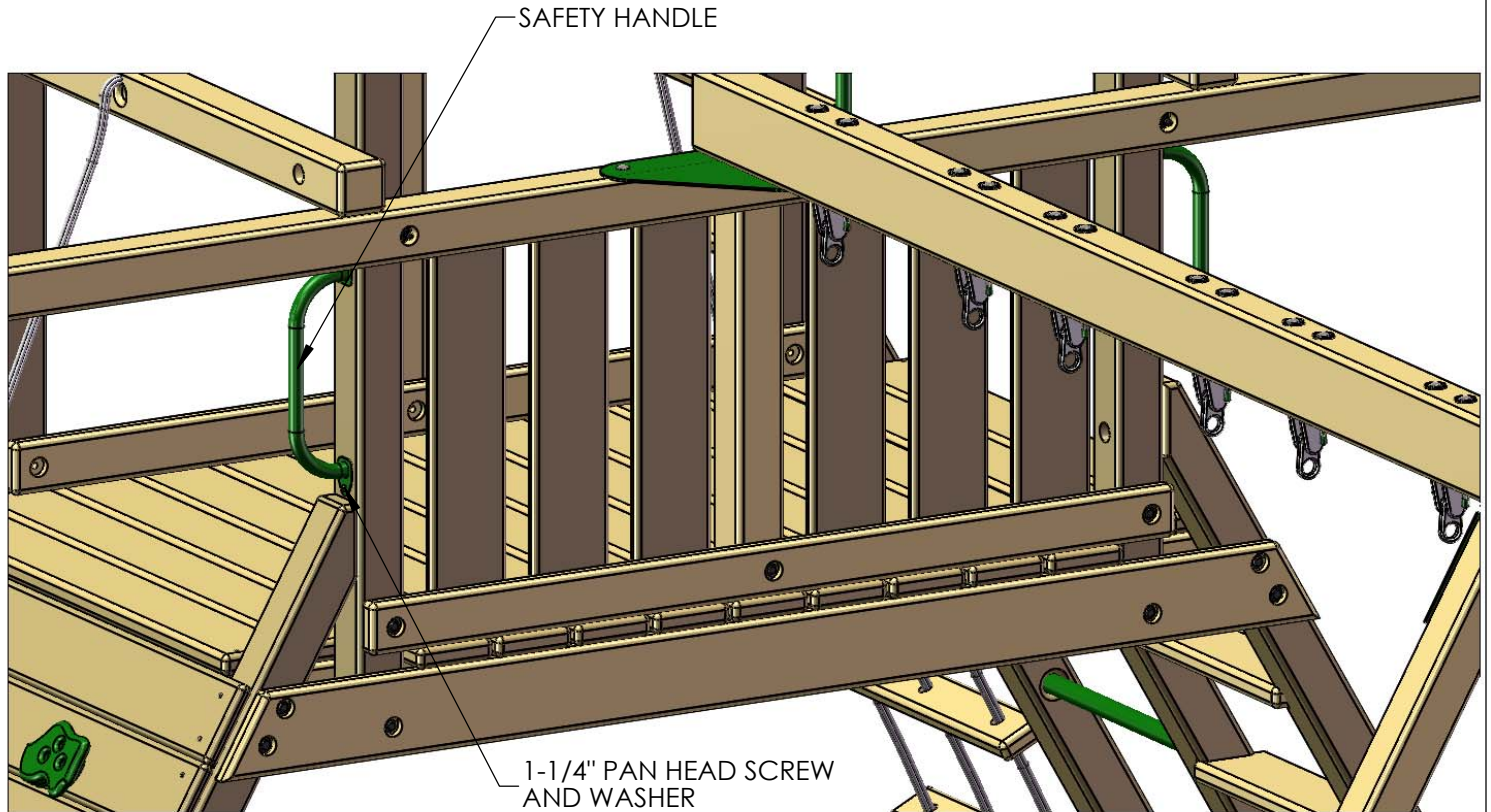

STEP 45: TIC TAC TOE PANEL

1: ASSEMBLE THE TIC TAC TOE PANEL ACCORDING TO THE INSTRUCTIONS IN THE BOX. **IGNORE** STEP 6 & 7 IN THE INSTRUCTIONS.

2: ATTACH THE TWO 1-3/8" X 1-5/8" X 10-1/2"L TIC TAC TOE BOARDS TO THE GREEN PLASTIC BRACKETS WITH THE 1" L PHILLIPS HEAD SCREWS PROVIDED IN THE TIC TAC TOE BOX. **IMPORTANT:** MAKE SURE THE TIC TAC TOE BOARD IS MOUNTED TO THE GREEN BRACKET OBSERVING THE 1-5/8" DIMENSION SHOWN BELOW.

3: PLACE THE UNIT ON THE PANEL SLATS AS SHOWN.

4: MOUNT THE LOWER TIC TAC TOE BOARD 4" ABOVE THE DECK. ATTACH THE TIC TAC TOE BOARDS TO THE PANEL SLATS FROM OUTSIDE THE FORT WITH #8 X 2" WOOD SCREWS.

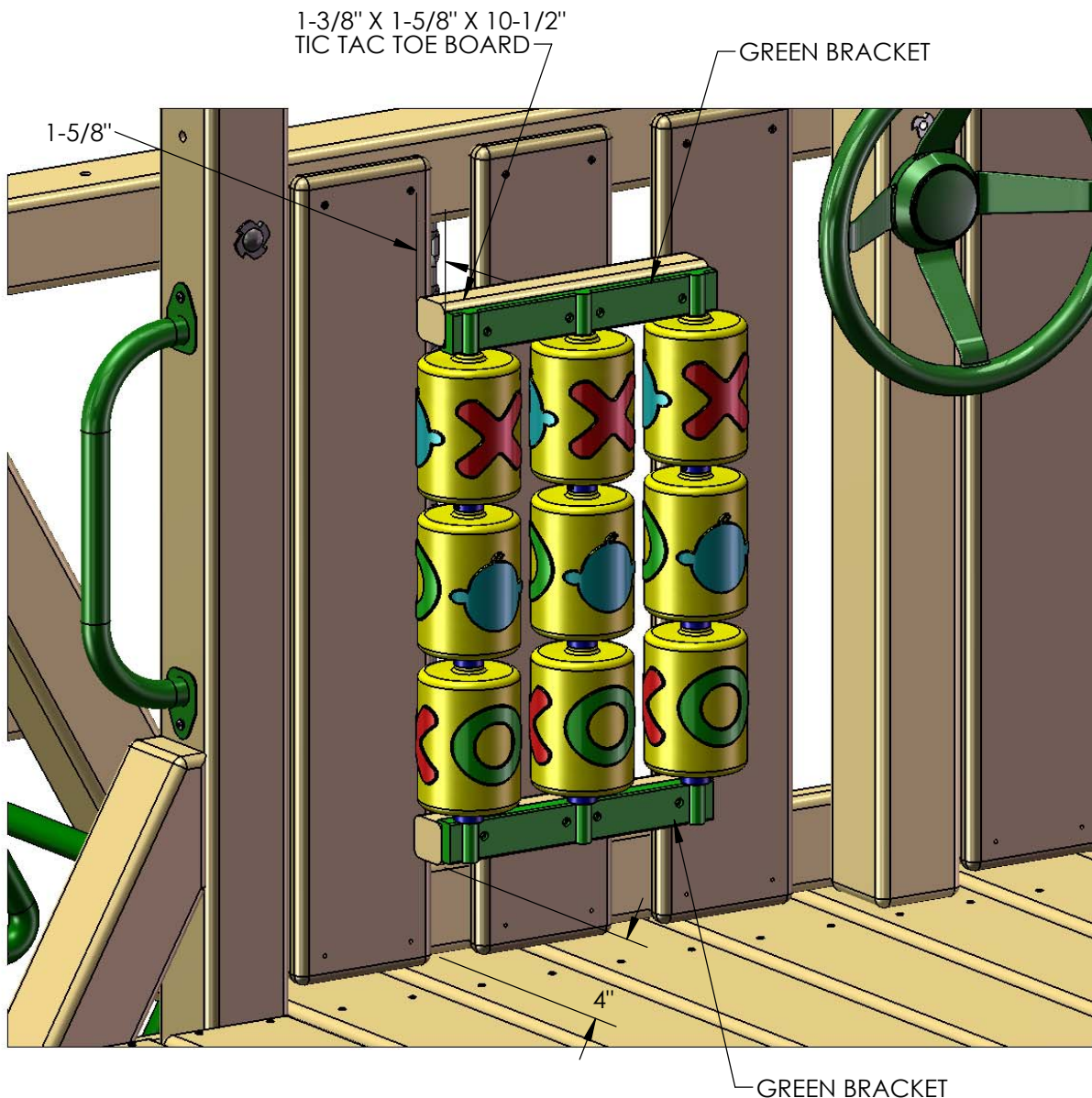

STEP 46: HANGING SWINGS

- 1: CLIP EACH OF THE SPRING CLIPS ONTO THE IRON DUCTILE SWING HANGERS, THEN CLIP ONTO THE SWING CHAINS.
- 2: USE THE CLIPS TO ADJUST THE HEIGHT OF THE SWING BY CLIPPING ON HIGHER OR LOWER LINKS.
- 3: COUNT BACK THE SAME NUMBER OF LINKS ON THE OPPOSITE SIDE TO ENSURE THAT THE SWINGS ARE LEVEL, AND ADJUST TO FIT YOUR NEEDS.

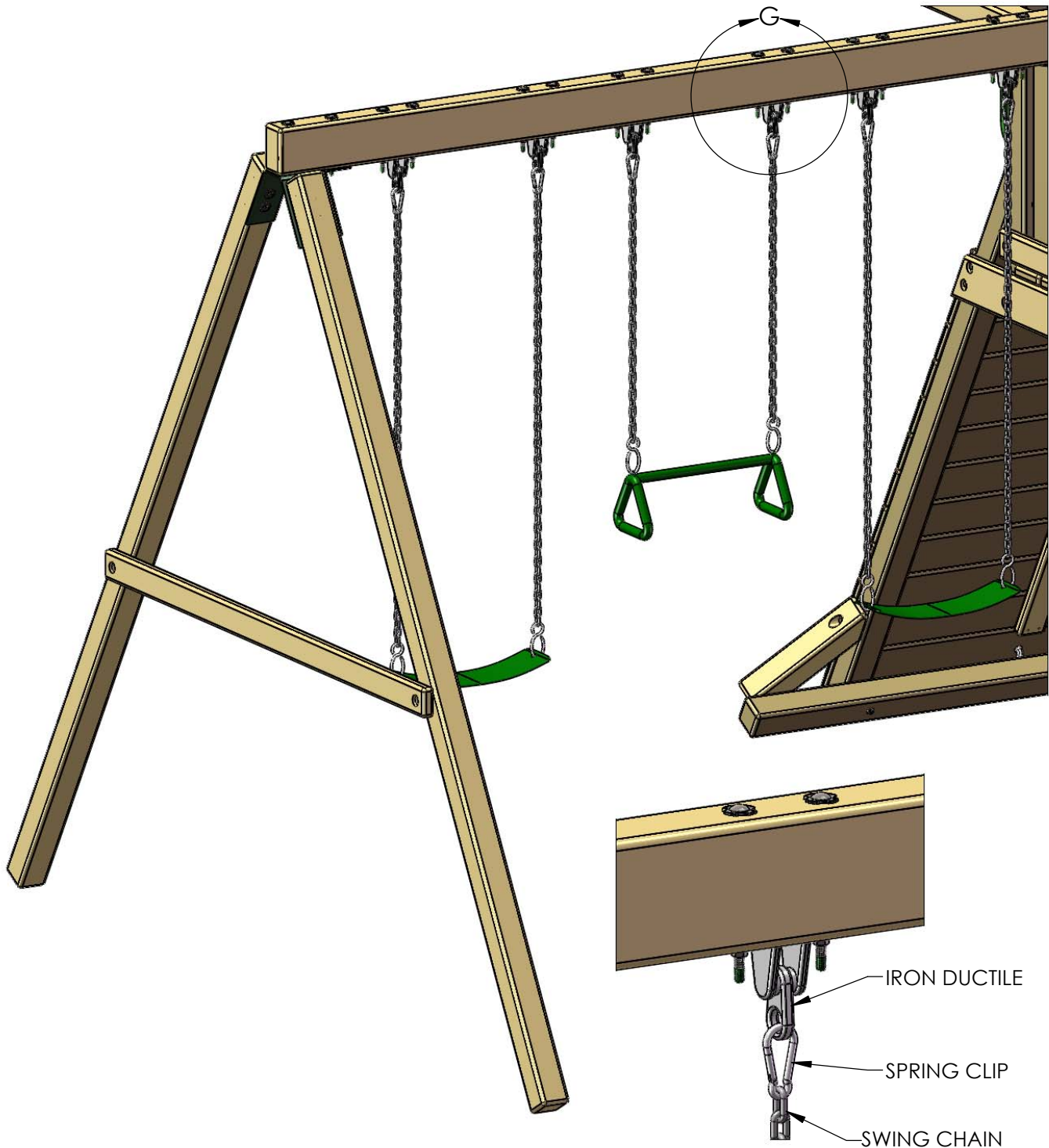

DETAIL G
SCALE 1 : 6

STEP 47: HANGING THE TIRE SWING

- 1: HANG THREE SPRING CLIPS FROM THE TIRE SWIVEL.
- 2: HANG ONE OF THE CHAINS IN ONE OF THE SPRING CLIPS AT THE DESIRED HEIGHT.
- 3: CONTINUE THE PROCESS WITH THE REMAINING CHAINS, MAKING SURE THAT THE TIRE SWING IS LEVEL WHEN FINISHED.
- 4: ANY EXCESS LENGTH OF CHAIN CAN BE LOOPED BACK AND HUNG MULTIPLE TIMES TO PREVENT THE EXCESS FROM HANGING DOWN AND CREATING A HAZARD.



STEP 48: GROUND STAKES

1: PLACE THE GROUND STAKES ON THE OUTSIDE OF THE SWING LEGS AS SHOWN BELOW.

2: HAMMER EACH GROUND STAKE IN AT AN ANGLE SIMILAR TO WHAT IS SHOWN. USE CAUTION WHEN HAMMERING SO THAT YOU DO NOT MAR THE WOOD. LEAVE THE TOP PORTION OF THE GROUND STAKE ABOVE THE GROUND FAR ENOUGH SO THAT YOU CAN STILL GET THE SCREW INTO THE HOLE AT THE TOP OF THE STAKE.

3: SECURE EACH STAKE TO THE SWING LEGS WITH THE SCREWS PROVIDED WITH THE STAKES.

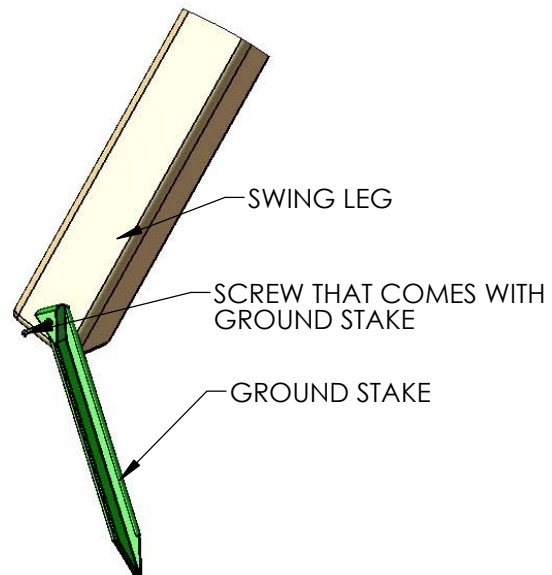
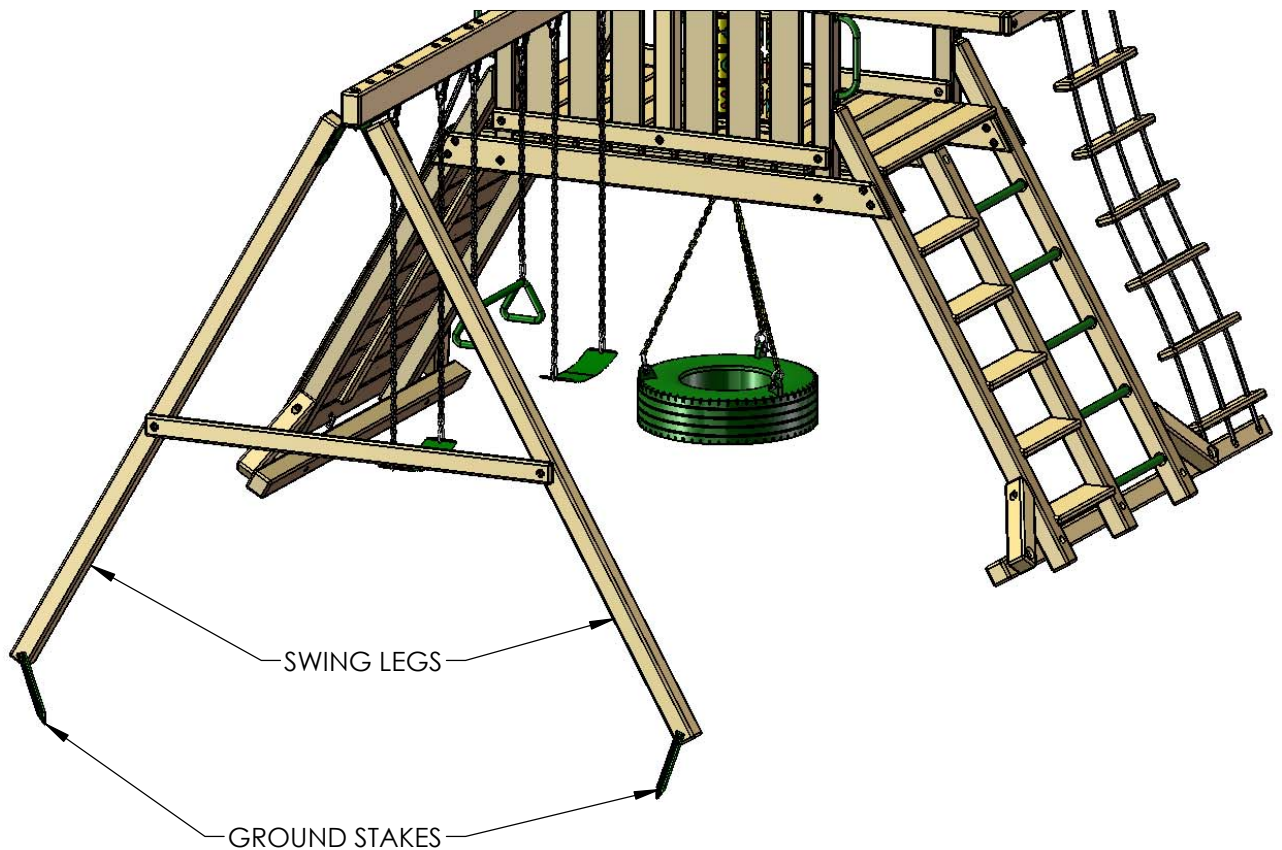

DETAIL A
SCALE 1 : 8

STEP 49: NAMEPLATE

1: ATTACH THE MANUFACTURER NAMEPLATE CENTERED ON THE FRONT OF YOUR SWING BEAM WITH TWO 2" WOOD SCREWS.

PLACE NAME PLATE
HERE AND ATTACH.

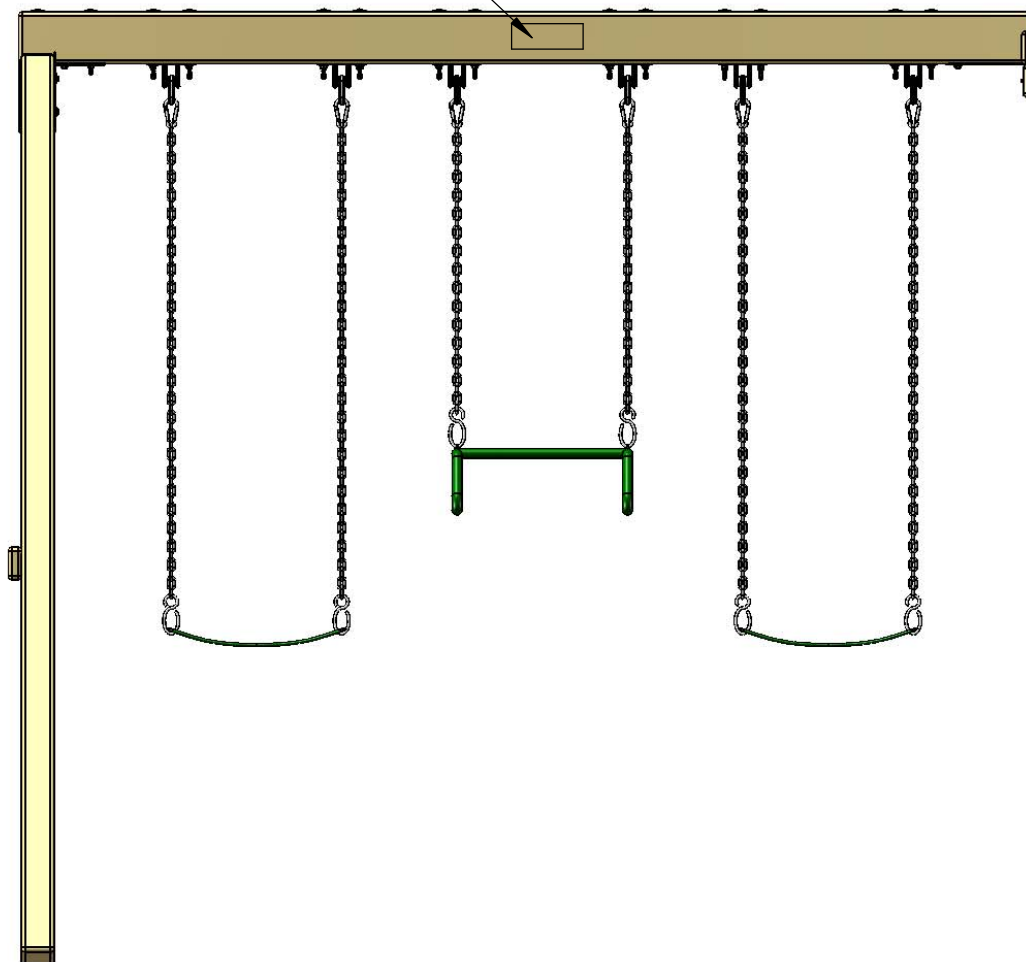

PART II
721-723 UPPER LEVEL

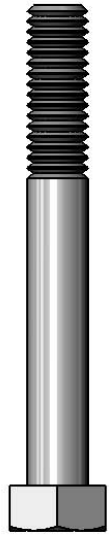

5/16 X 2-1/2"
 HEX BOLT
 QTY: 2



5/16 X 1-1/2"
 HEX BOLT
 QTY: 4

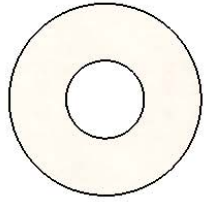

3/8" WASHER
 QTY: 28

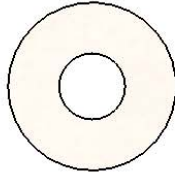

5/16" WASHER
 QTY: 85

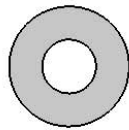

1/4" WASHER
 QTY: 7

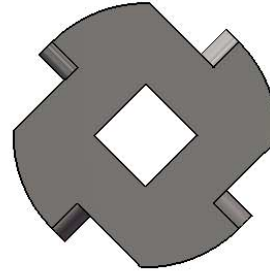

TORQUE WASHER
 QTY: 2

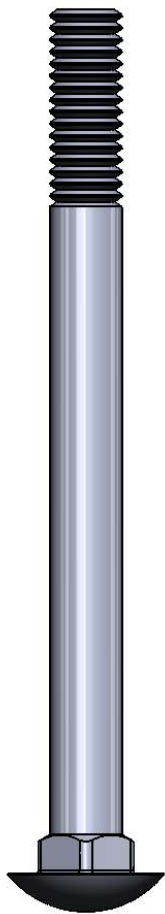

3/8 X 4-1/2"
 CARRIAGE BOLT
 QTY: 2



5/16 X 4-1/2"
 HEX BOLT
 QTY: 39

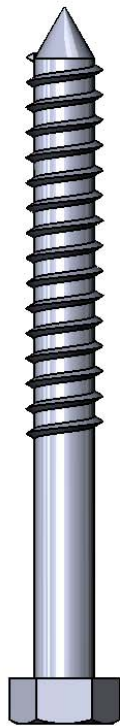

5/16" X 3-1/2"
 HEX LAG
 SCREW
 QTY: 34

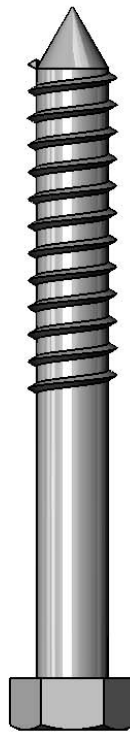

3/8 X 3-1/2"
 HEX LAG SCREW
 QTY: 13

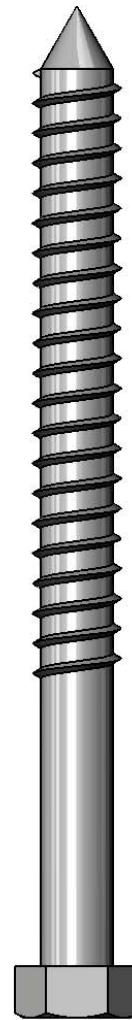

3/8 X 5"
 HEX LAG SCREW
 QTY: 13

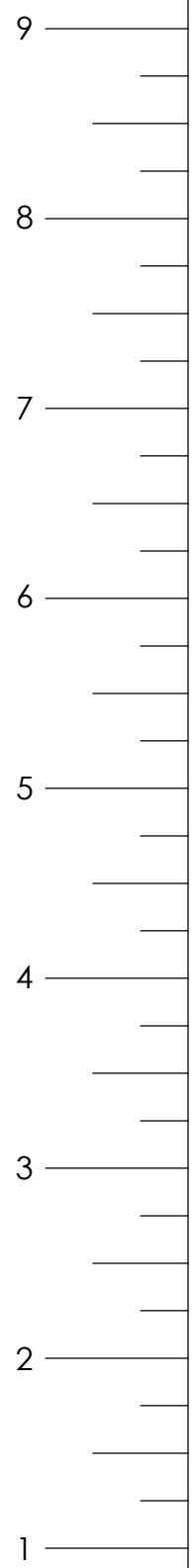

USE THE RULER TO THE RIGHT TO MEASURE YOUR BOLTS AND SCREWS. PICTURE VIEWS SHOWN ABOVE ARE 1:1 SCALE AND CAN BE USED TO MATCH BOLT AND SCREW SIZES.

#8 X 2"
 WOOD SCREW
 QTY: 207



#8 X 2-1/2"
 WOOD SCREW
 QTY: 49



#8 X 3"
 WOOD SCREW
 QTY: 9

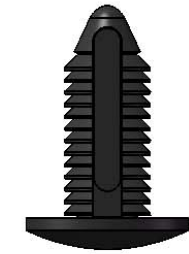

BLACK PLUG
 QTY: 6

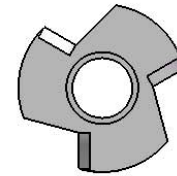

5/16" TEE NUT
 QTY: 47

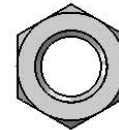

3/8" LOCK NUT
 QTY: 2



PLASTIC
 BOLT CAP
 QTY: 2

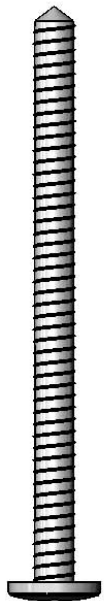

#14 X 3"
 PAN HEAD
 SCREW
 QTY: 3

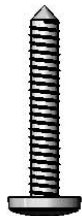

#14 X 1"
 PAN HEAD
 SCREW
 QTY: 4



#2 SQUARE
 DRIVE BIT
 QTY: 1

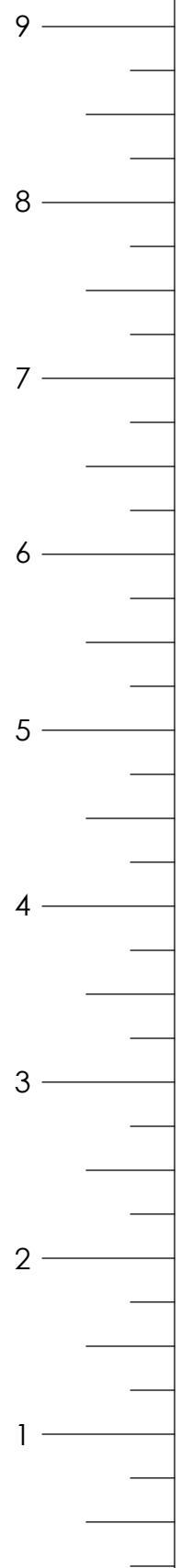

USE THE RULER TO THE RIGHT TO MEASURE YOUR BOLTS AND SCREWS. PICTURE VIEWS SHOWN ABOVE ARE 1:1 SCALE AND CAN BE USED TO MATCH BOLT AND SCREW SIZES.

#8 X 1-1/4"
WOOD SCREW
QTY: 14



#8 X 1-1/2"
WOOD SCREW
QTY: 140



#8 X 2"
WOOD SCREW
QTY: 35



#8 X 2-1/2"
WOOD SCREW
QTY: 8



#8 X 3"
WOOD SCREW
QTY: 4



5/16" X 4-1/2"
HEX BOLT
QTY: 4

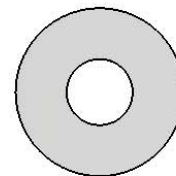

5/16" WASHER
QTY: 4

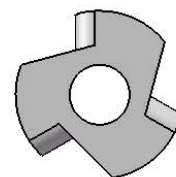

5/16" TEE NUT
QTY: 4

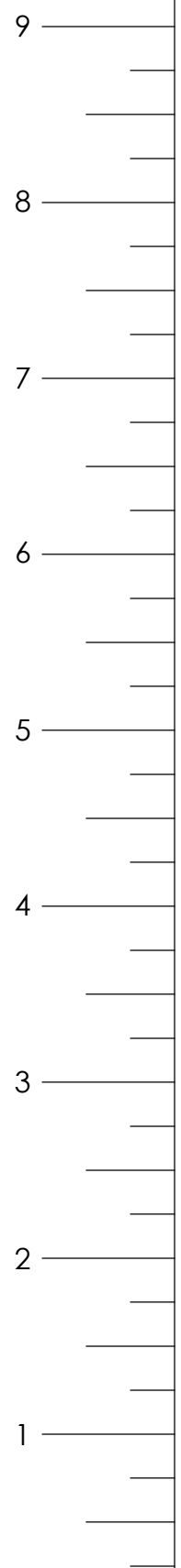

USE THE RULER TO THE RIGHT TO MEASURE YOUR BOLTS AND SCREWS. PICTURE VIEWS SHOWN ABOVE ARE 1:1 SCALE AND CAN BE USED TO MATCH BOLT AND SCREW SIZES.

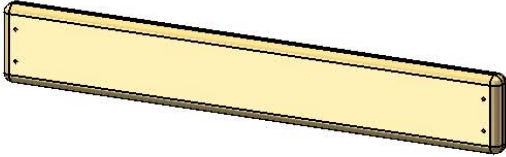
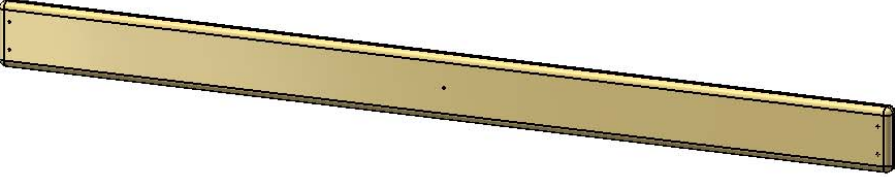
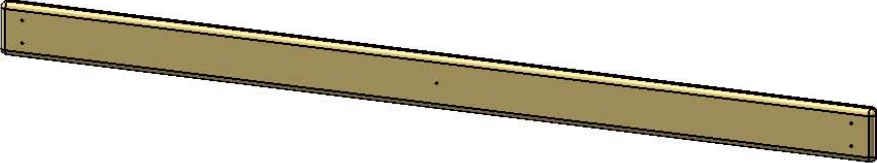
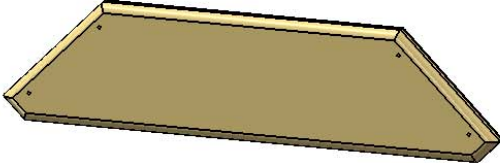
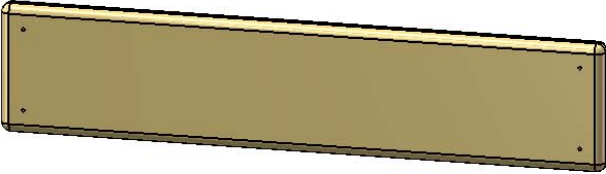
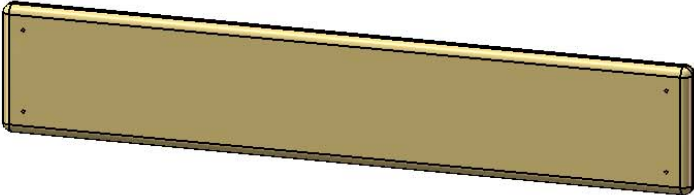
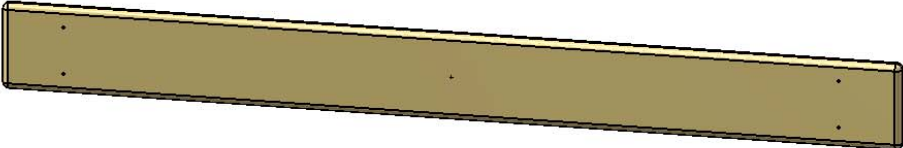
PICTURE	DESCRIPTION	QTY.
	5/4 X 4 X 23.88" DECK SPACER 125-4-2388-DS	4
	5/4 X 4 X 51.25" DECK SPACER 125-4-5125-DS	1
	5/4 X 4 X 58.13" DECK FILLER 125-4-5813-DF	1
	5/4 X 6 X 22" SANDBOX SEAT 125-6-2200-SS	2
	5/4 X 6 X 26" PANEL SLAT 125-6-2600-PS	4
	5/4 X 6 X 30.5" PANEL SLAT 125-6-3050-PS	10
	5/4 X 6 X 58.13" DECK BOARD 125-6-5813-DB	10

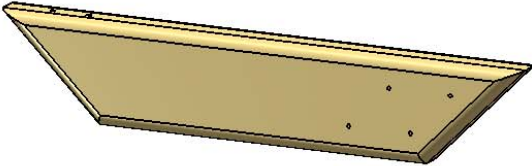
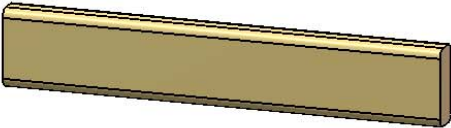
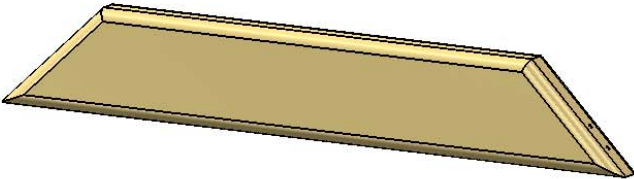
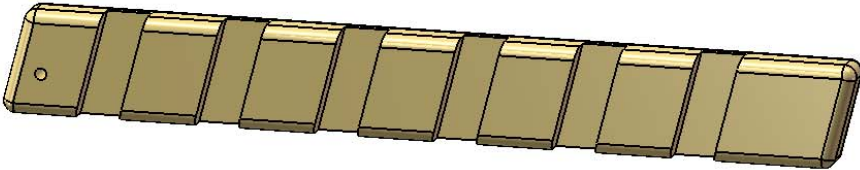
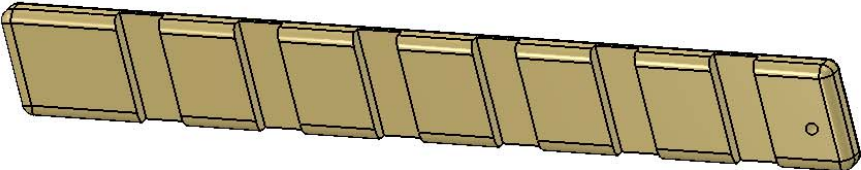
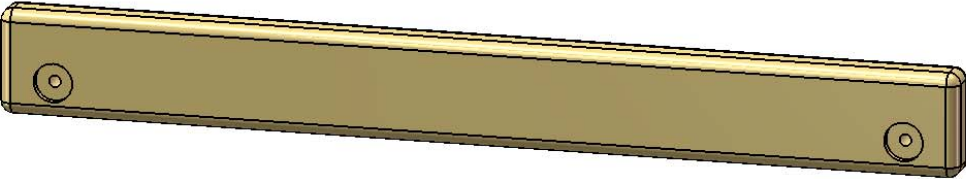
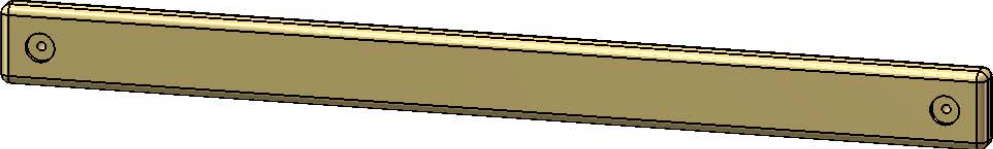
PICTURE	DESCRIPTION	QTY.
	<p>2 X 4 X 18" ANGLE SUPPORT</p> <p>2-4-1800-AS</p>	<p>6</p>
	<p>2 X 4 X 19.38" LADDER STEP</p> <p>2-4-1938-LS</p>	<p>12</p>
	<p>2 X 4 X 21.5" ANGLE SUPPORT</p> <p>2-4-2150-AS</p>	<p>2</p>
	<p>2 X 4 X 27.55" LADDER RIGHT SIDE</p> <p>2-4-2755-LLS</p>	<p>2</p>
	<p>2 X 4 X 27.55" LADDER LEFT SIDE</p> <p>2-4-2755-LRS</p>	<p>2</p>
	<p>2 X 4 X 31" DECK SUPPORT/ PANEL BOARD</p> <p>2-4-3100-DSPB</p>	<p>7</p>
	<p>2 X 4 X 42.5" BOTTOM PANEL BOARD</p> <p>2-4-4250-BPB</p>	<p>3</p>

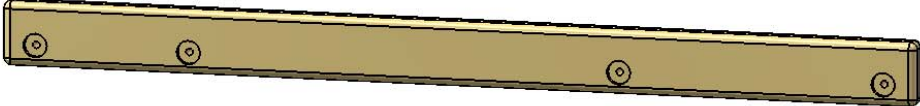
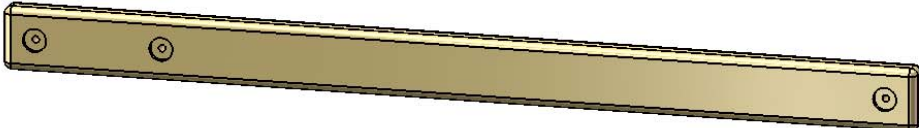
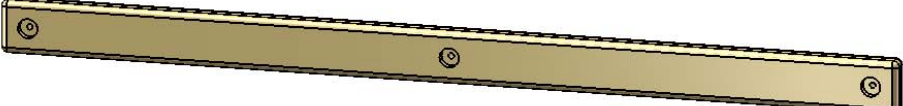
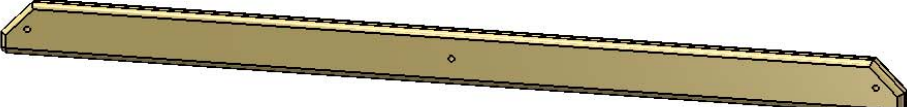
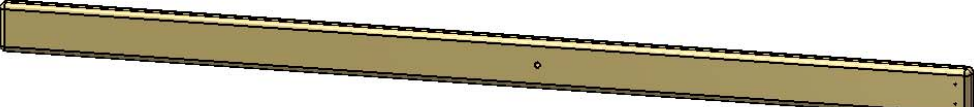
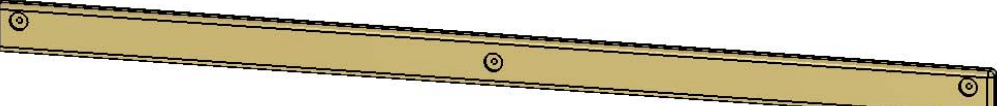

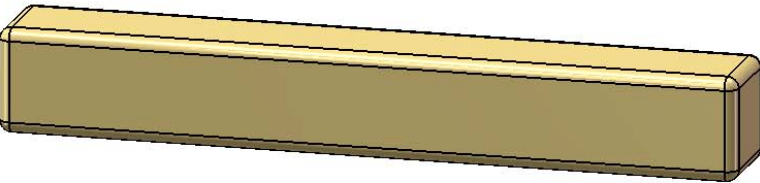

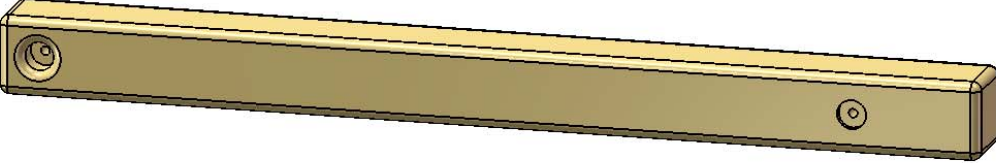
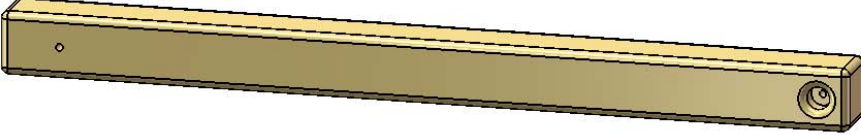
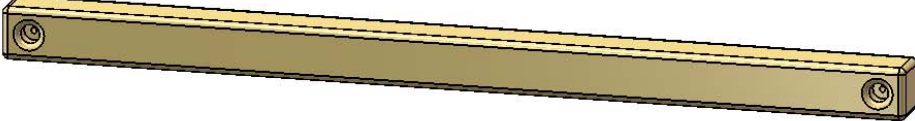
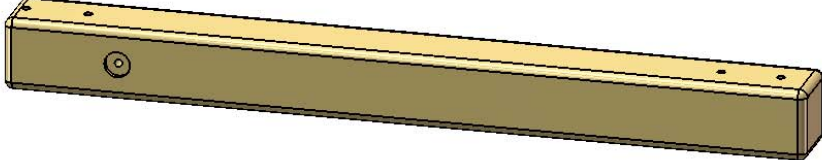
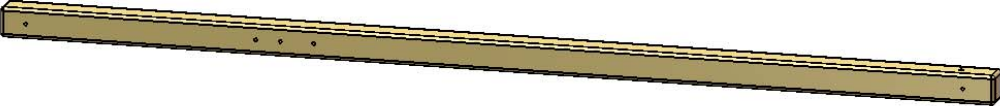
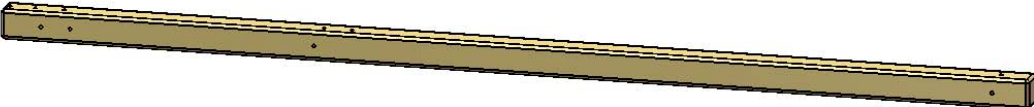
PICTURE	DESCRIPTION	QTY.
	2 X 4 X 49.19" CENTER DECK SUPPORT 2-4-4919-CDS	2
	2 X 4 X 49.19" DECK SUPPORT 2-4-4919-DS	2
	2 X 4 X 58" FILLER PANEL BOARD 2-4-5800-FPB	1
	2 X 4 X 58.38" SAFETY BAR 2-4-5838-SB	1
	2 X 4 X 58.38" SANDBOX SAFETY BAR 2-4-5838-SBSB	1
	2 X 4 X 68" CENTER POST 2-4-6800-CP	2
	2 X 4 X 70" TOP PANEL BOARD 2-4-7000-TPB	2

PICTURE	DESCRIPTION	QTY.
	2 X 6 X 31" SANDBOX BOARD/ BOTTOM PANEL BOARD 2-6-3100-SBBPB	4
	2 X 6 X 58.38" TOP PANEL BOARD 2-6-5838-TPB	1
	2 X 6 X 58.38" SANDBOX BOARD 2-6-5838-SBB	2
	4 X 4 X 10.13" CENTER POST 4-4-1013-CP	1
	4 X 4 X 21.13" DECK BLOCK 4-4-2113-DB	2
	4 X 4 X 23.88" CENTER DECK SUPPORT/ SLIDE BLOCK 4-4-2388-CDSSB	2
	4 X 4 X 35.13" CENTER DECK SUPPORT 4-4-3513-CDS	1

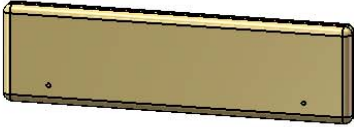
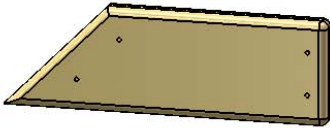
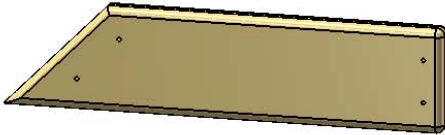
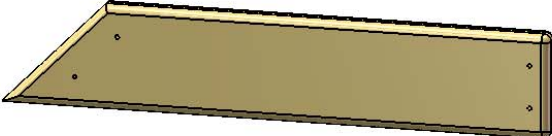
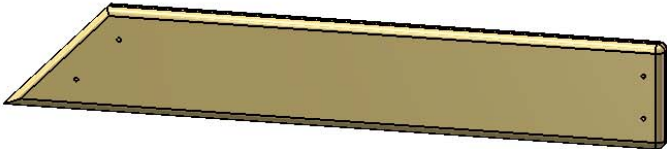
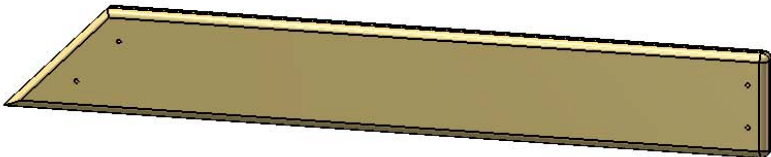
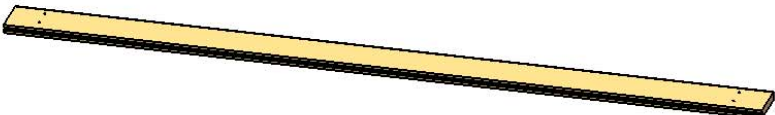
PICTURE	DESCRIPTION	QTY.
	4 X 4 X 42.28" CENTER POST 4 X 4 X 4228-CP	1
	4 X 4 X 45.68" CENTER POST 4-4-4568-CP	1
	4 X 4 X 58.38" DECK SUPPORT 4-4-5838-DS	3
	4 X 4 X 38.88" CENTER POST 4-4-3888-CP	2
	4 X 4 X 117.84" MIDDLE POST 4-4-11784-MP	2
	4 X 4 X 121.88" CORNER POST 4-4-12188-CP	2
		90

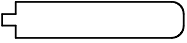
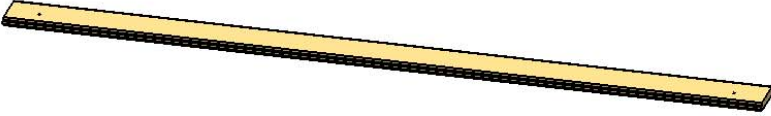
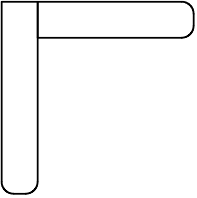
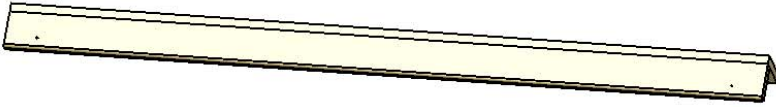
PICTURE	DESCRIPTION	QTY.
	<p>2 X 4 X 58" FILLER PANEL BOARD</p> <p>2-4-5800-FPB</p>	<p>1</p>
	<p>2 X 4 X 58.38" TARP BOARD</p> <p>2-4-5838-TB</p>	<p>3</p>
	<p>4 X 4 X 24.38" FILLER POST</p> <p>4-4-2438-FP</p>	<p>1</p>
		<p>91</p>

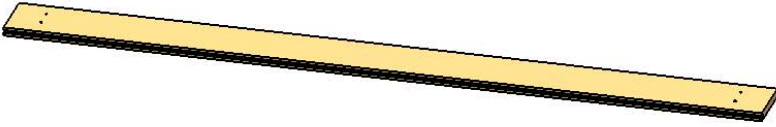
PICTURE	DESCRIPTION	QTY.
	<p>1 X 3 X 11.25" WINDOW TOP & BOTTOM BOARD 1-3-1125-WTBB</p>	<p>4</p>
	<p>1 X 4 X 10.5" WALL PANEL BOARD 1-4-1050-WPB</p>	<p>2</p>
	<p>1 X 4 X 14.25" WALL PANEL BOARD 1-4-1425-WPB</p>	<p>2</p>
	<p>1 X 4 X 17.75" WALL PANEL BOARD 1-4-1775-WPB</p>	<p>2</p>
	<p>1 X 4 X 21.38" WALL PANEL BOARD 1-4-2138-WPB</p>	<p>2</p>
	<p>1 X 4 X 24.75" WALL PANEL BOARD 1-4-2475-WPB</p>	<p>2</p>
	<p>1 X 4 X 65.38" ROOF STARTER 1-4-6538-RS</p>	<p>2</p>

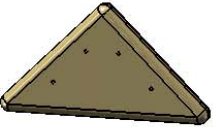
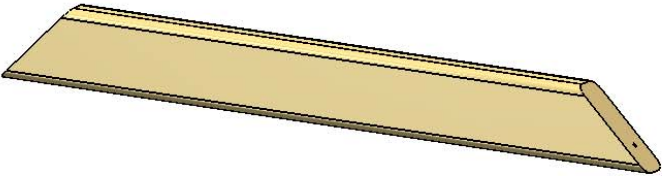
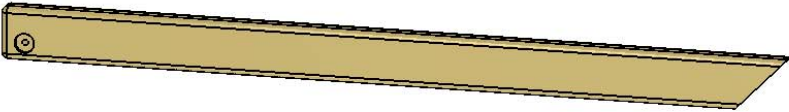
PICTURE	DESCRIPTION	QTY.
 	<p>1 X 4 X 65.38" ROOF FINISHER</p> <p>1-4-6538-RF</p>	<p>2</p>
 	<p>1 X 5 X 65.38" ROOF PEAK</p> <p>1-5-6538-RP</p>	<p>1</p>
 	<p>1 X 6 X 65.38" ROOF BOARD</p> <p>1-6-6538-RB</p>	<p>17</p>
	<p>5/4 X 2 X 8" RUN RAY</p> <p>125-2-0800-SR</p>	<p>12</p>
	<p>5/4 X 6 X 10" ROOF PEAK SUPPORT</p> <p>125-6-1000-RPS</p>	<p>2</p>
	<p>2 X 4 X 31.19" SUN SUPPORT</p> <p>2-4-3119-SS</p>	<p>2</p>
	<p>2 X 4 X 50.77" ROOF SUPPORT LEFT</p> <p>2-4-5077-RSL</p>	<p>2</p>

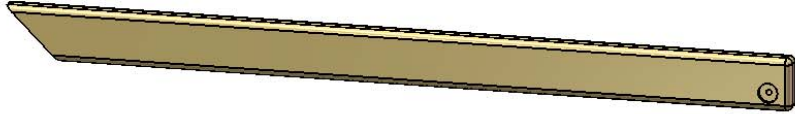
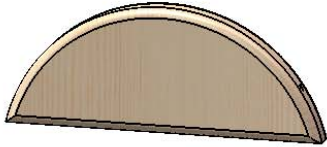
PICTURE	DESCRIPTION	QTY.
	<p>2 X 4 X 50.77" ROOF SUPPORT RIGHT</p> <p>2-4-5077-RSR</p>	<p>2</p>
	<p>2 X 6 X 13.63" SUN</p> <p>2-6-1363-S</p>	<p>2</p>
		<p>94</p>

PICTURE

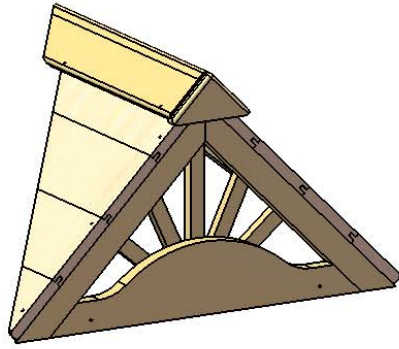

DESCRIPTION

UNASSEMBLED
DORMER
725 BOX

QTY.

1

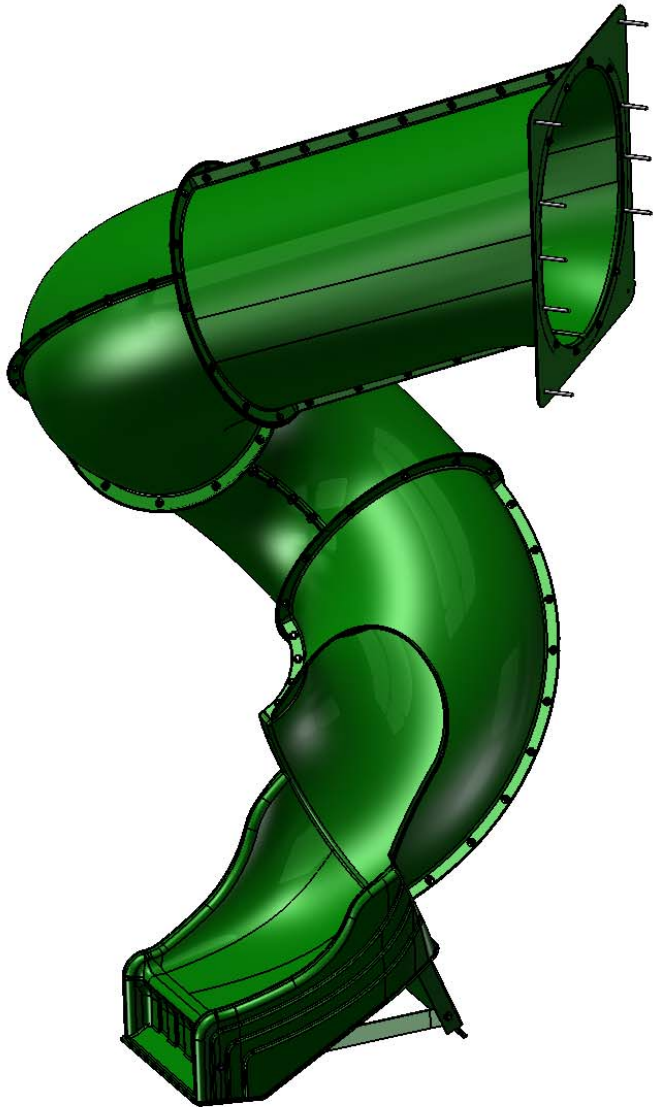

RAD
RIDE SLIDE
03-0002

1

PICTURE

DESCRIPTION

QTY.



PUNCHING
BAG
09-0002

1

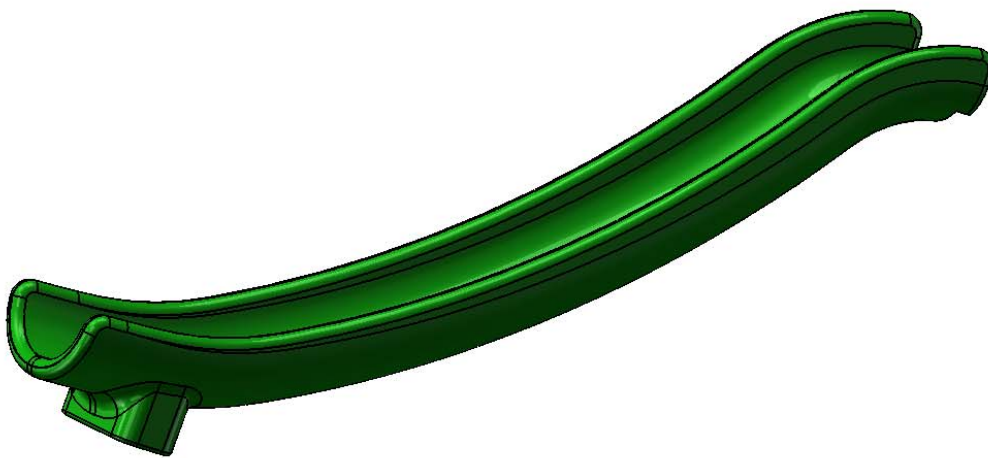

SUPER
SCOOP
03-0007

1

PICTURE

DESCRIPTION

QTY.

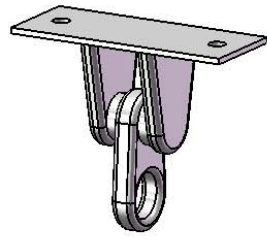

IRON DUCTILE
SWING
HANGER

11-4012

1

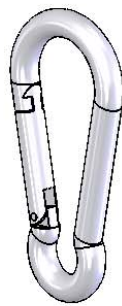

SPRING
CLIP

11-4003

1

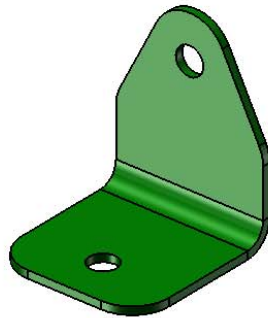

90° GREEN
BRACKET
11-5013

4

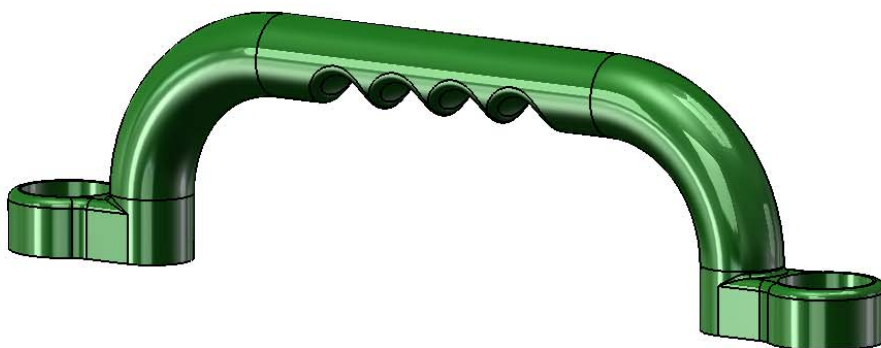

SAFETY
HANDLE
(PAIR)
07-0005

2pr

PICTURE

DESCRIPTION

QTY.

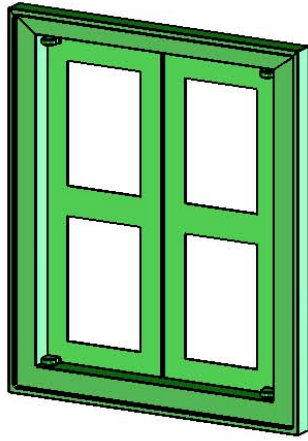

WINDOW
07-0013

2

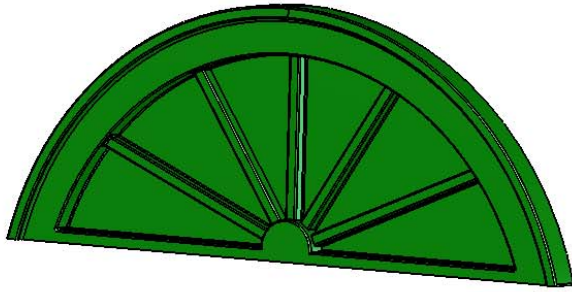

CROWN
07-0019

1

721 & 723 HARDWARE BOXES

HARDWARE
BOXES

1 ea

STEP 1: ATTACHING T-NUTS TO THE POSTS

1: THIS STEP IS CRITICAL TO BUILDING THE FORT PROPERLY. IF ANY MISTAKES ARE MADE HERE, YOU WILL NEED TO DIS-ASSEMBLE AND THEN RE-ASSEMBLE TO MAKE YOUR CORRECTIONS.

2: MAKE SURE HOLES ARE FREE OF ANY OBSTRUCTIONS. USE A BOLT TO CLEAN OUT ANY DEBRIS.

3: LAY OUT EACH OF THE 4 X 4 X 117.84" MIDDLE POSTS AND 4 X 4 X 121.875 CORNER POSTS IN THE AREA YOU INTEND ON BUILDING THE UPPER LEVEL SIDE OF THE PLAYSET.

4: USE THE DIAGRAM BELOW TO CORRECTLY IDENTIFY AND ORIENT THE NECESSARY DIRECTION THE POSTS SHOULD FACE.

5: USE A HAMMER TO SEAT THE T-NUTS AFTER INSERTING THEM INTO THE HOLES SHOWN IN THE DIAGRAM BELOW.

6: THE BARREL OF THE T-NUT SHOULD GO IN THE HOLE FIRST. HAMMER THE T-NUT UNTIL IT IS FLUSH/ALMOST FLUSH TO THE CORNER POSTS.

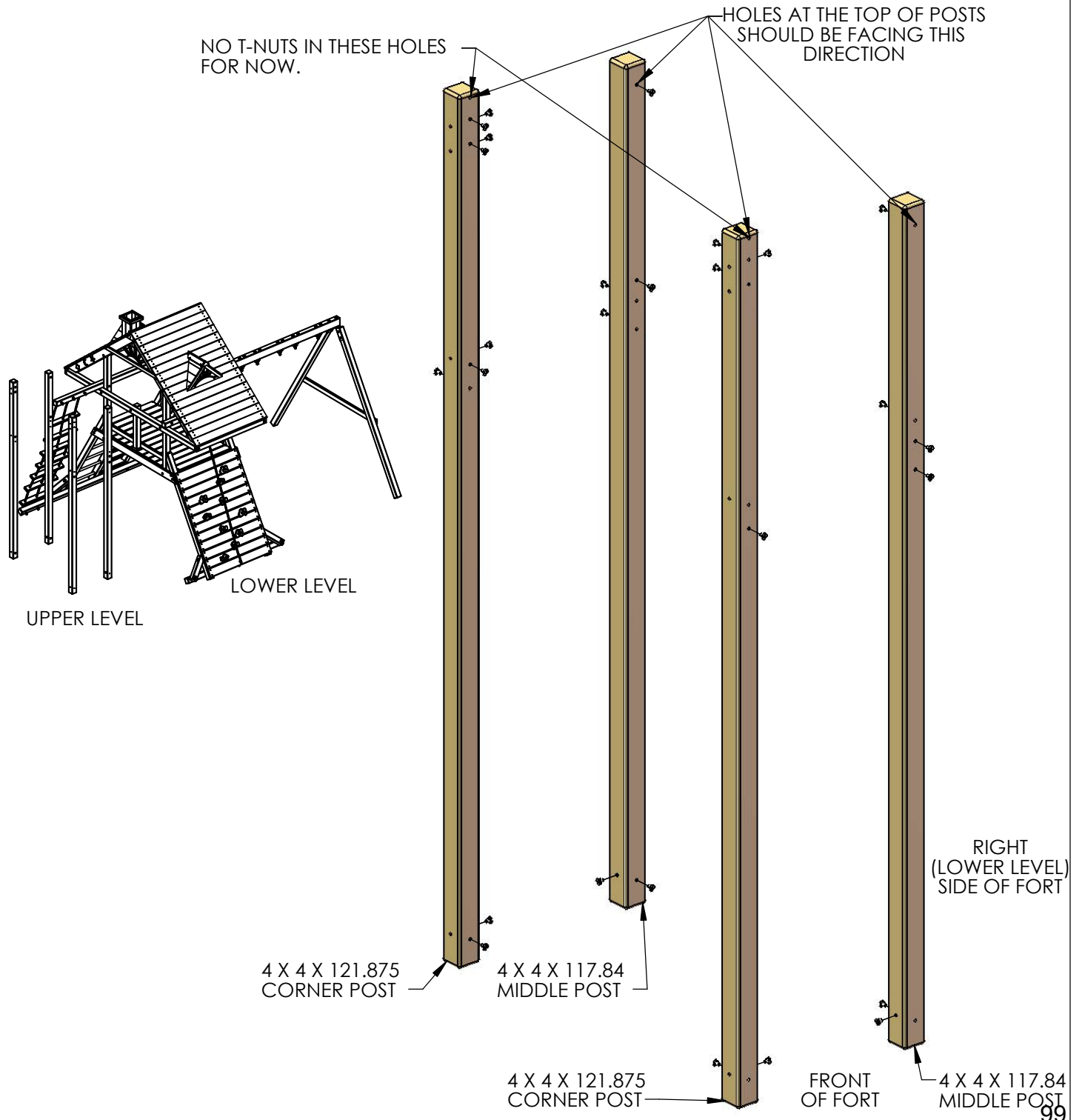

STEP 2: ASSEMBLING THE UPPER LEVEL SIDE FRAME

1: LAY THE POSTS ON THE GROUND IN THEIR PROPER ORIENTATION.

2: LAY THE 2 X 6 X 31.00 SANDBOX BOARD ON TOP OF THE CORNER POST AT THE BOTTOM. THE HOLES IN THE SANDBOX BOARD MUST BE OFFSET DOWN. USE 5/16" X 4-1/2" HEX BOLTS AND 5/16" WASHERS TO ATTACH THE TOP HOLES OF THE SANDBOX BOARD TO THE T-NUTS INSTALLED ON THE POSTS. THE BOTTOM HOLES WILL BE USED LATER.

3: LAY THE 2 X 4 X 31.00 DECK SUPPORT/PANEL BOARD ON TOP OF THE CORNER POSTS AT THE TOP. THE HOLES IN THE DECK SUPPORT/PANEL BOARD MUST BE OFFSET UP. USE 5/16" X 4-1/2" HEX BOLTS AND 5/16" WASHERS TO ATTACH THE DECK SUPPORT/PANEL BOARD TO THE T-NUTS INSTALLED ON THE POSTS.

4: FLIP OVER THE ASSEMBLED FRAME AND LAY THE 2 X 4 X 31.00 DECK SUPPORT/PANEL BOARD ON TOP OF THE POSTS. USE THE SET OF HOLES LOCATED ABOVE THE SANDBOX BOARDS IN BETWEEN THE TWO BOARDS PREVIOUSLY INSTALLED. THE HOLES IN THE DECK SUPPORT/PANEL BOARD MUST BE OFFSET DOWN. USE 5/16" X 4-1/2" HEX BOLTS AND 5/16" WASHERS TO ATTACH THE DECK SUPPORT/PANEL BOARD TO THE T-NUTS INSTALLED ON THE POSTS.

5: DO NOT INSTALL ANY LAG SCREWS AT THIS TIME.

6: REPEAT SUB-STEPS 1 TO 4 FOR THE OPPOSITE SIDE.

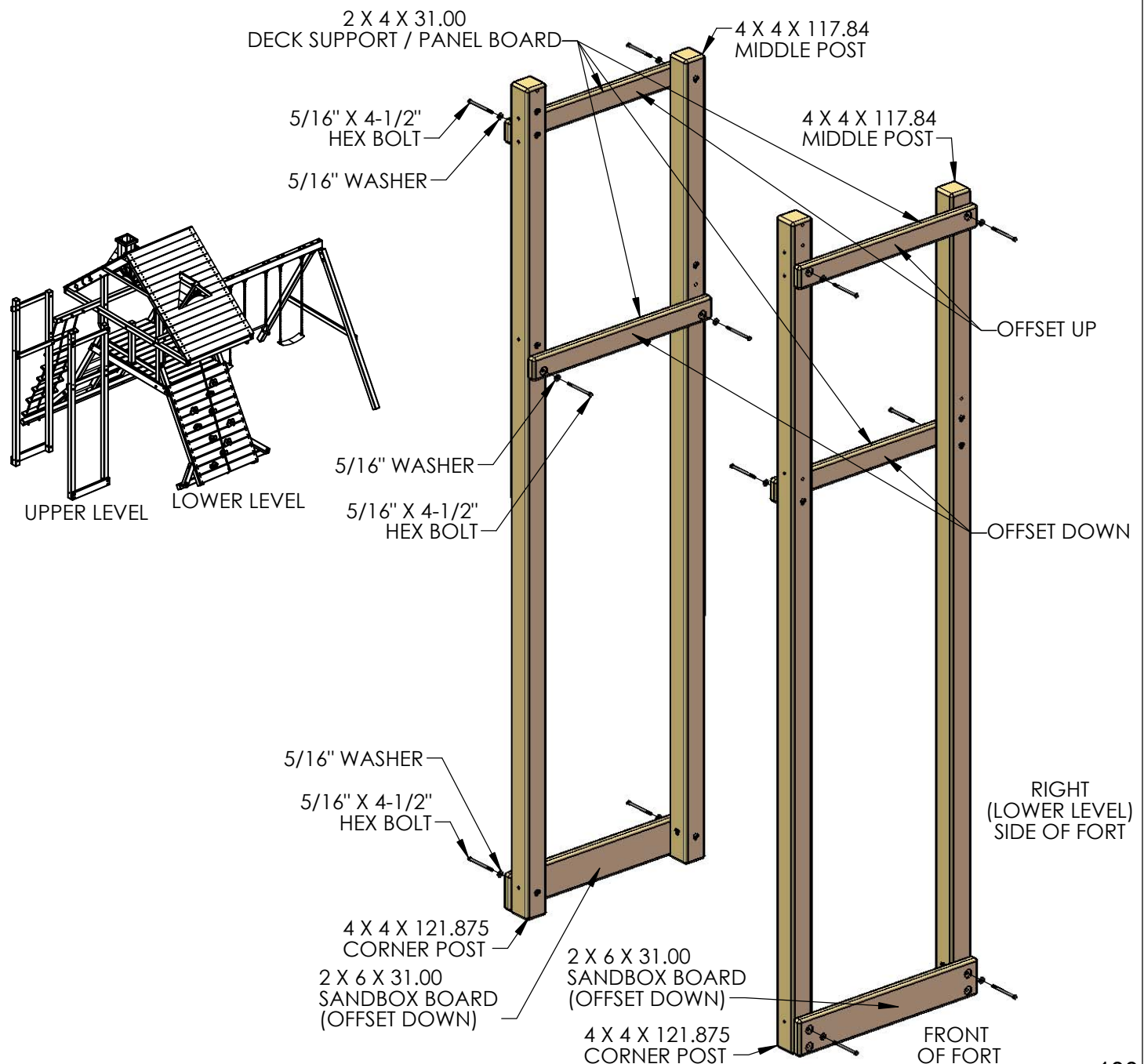

STEP 3: SANDBOX BOARDS AND TOP PANEL BOARD

YOU WILL NEED AN EXTRA PERSON FOR THIS STEP.

1: WITH HELP, STAND UP THE FRONT AND BACK SIDE ASSEMBLIES.

2: ATTACH ONE 2 X 6 X 58.38" SANDBOX BOARD TO THE BOTTOM OF THE POSTS OF BOTH FRAME ASSEMBLIES ON EACH SIDE, THE HOLES IN THE SANDBOX BOARDS MUST BE OFFSET UP. USE 5/16" X 4-1/2" HEX BOLTS AND 5/16" WASHERS TO ATTACH THE TOP HOLES OF THE SANDBOX BOARD TO THE T-NUTS INSTALLED ON THE POSTS. THE BOTTOM HOLES WILL BE USED LATER.

3: ATTACH THE 2 X 6 X 58.38" TOP PANEL BOARD AT THE TOP OF THE CORNER POSTS OF BOTH FRAME ASSEMBLIES, THE HOLES IN THE TOP PANEL BOARD MUST BE OFFSET DOWN. USE 5/16" X 4-1/2" HEX BOLTS AND 5/16" WASHERS TO ATTACH THE BOTTOM HOLES OF THE TOP PANEL BOARD TO THE T-NUTS INSTALLED ON THE POSTS. THE TOP HOLES WILL BE USED LATER.

4: DO NOT INSTALL ANY LAG SCREWS AT THIS TIME.

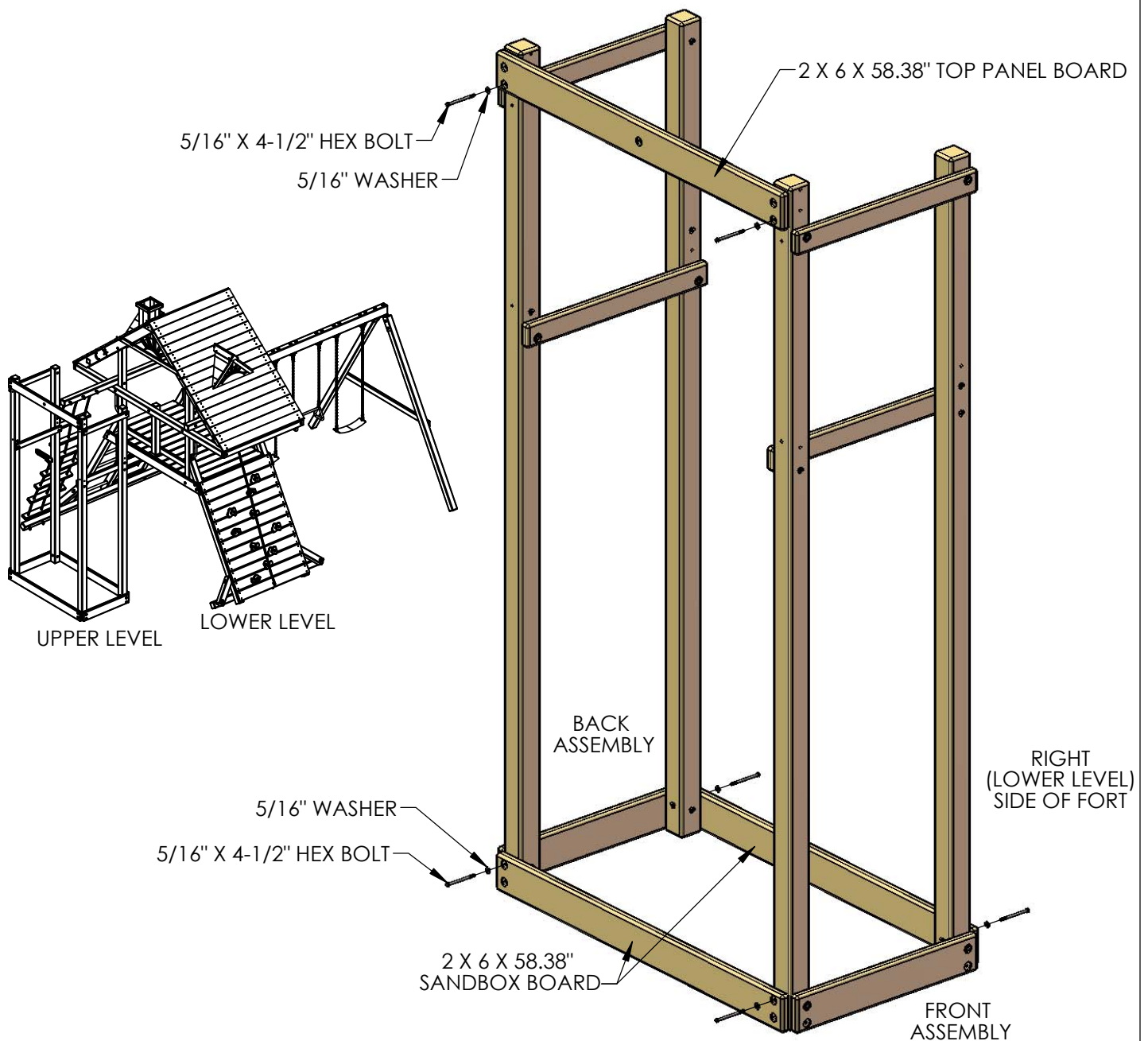

STEP 4: UPPER LEVEL UNDER DECK SUPPORTS

1: PLACE THE 4 X 4 X 58.38" UNDER DECK SUPPORT DIRECTLY UNDERNEATH THE DECK SUPPORTS. ATTACH THE UNDER DECK SUPPORT TO THE MIDDLE POSTS AND CORNER POSTS WITH 3/8" X 5" LAG SCREWS AND 3/8" WASHERS AS SHOWN IN THE DIAGRAM BELOW.

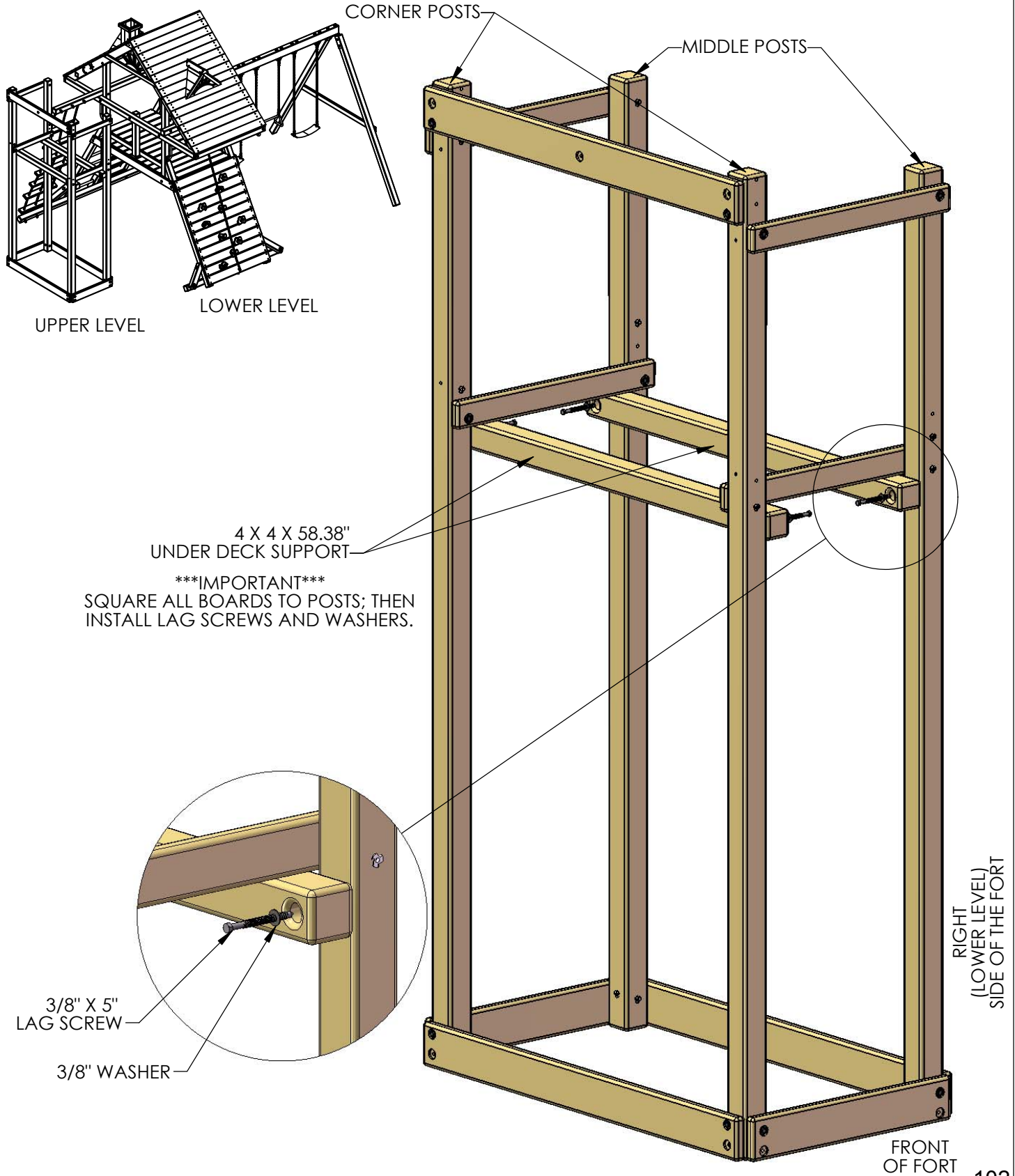

STEP 5: CONNECTING THE DECK SUPPORTS

1: PLACE THE 2 X 4 X 49.19 DECK SUPPORTS AGAINST THE UPPER LEVEL MIDDLE POSTS AND THE PLAYSET CORNER POSTS UNDERNEATH THE SIDE RAIL. USE 5/16" X 4-1/2" HEX BOLTS TO ATTACH THE DECK SUPPORTS TO THE T-NUTS INSTALLED ON THE CORNER POSTS.

2: PLACE THE UPPER LEVEL FRAME IN ITS FINAL POSITION AND FOLLOW THE PROCEDURES AT THE FRONT OF THE MANUAL TO LEVEL AND SQUARE THE STRUCTURE. HAVE AN ASSISTANT HELP YOU LIFT THE FRAME AS REQUIRED. **DO NOT** INSTALL REMAINING LAG SCREWS UNTIL AFTER THE FRAME HAS BEEN LEVELED AND SQUARED.

3: ONCE THE FRAME IS LEVEL, SQUARE AND SET INTO POSITION; GO BACK AND INSERT THE 5/16" X 3-1/2" LAG SCREWS AND 5/16" WASHERS IN ALL THE REMAINING HOLES OF THE 2 X 6 PARTS ON FRONT, TOP, REAR AND SIDES OF THE PLAY SET. NOTE: THERE WILL NOT BE ANY PREDRILLED HOLES IN THE CORNER POSTS FOR THE LAG SCREWS.

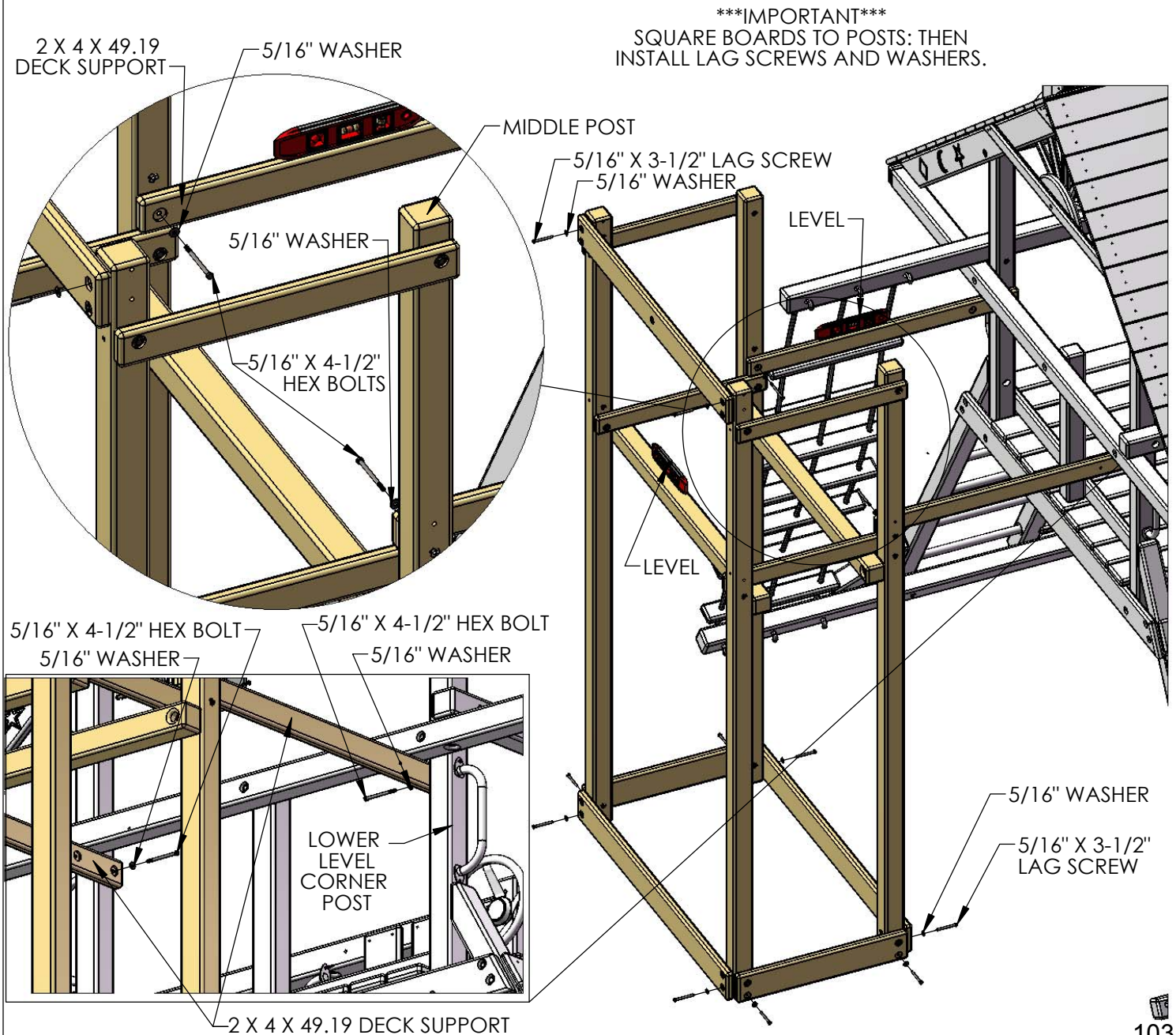

STEP 6: UPPER LEVEL CORNER POSTS

- 1: MAKE SURE HOLES ARE FREE OF ANY OBSTRUCTIONS. USE A BOLT TO CLEAN OUT ANY DEBRIS.
- 2: USING THE DIAGRAM BELOW, LAY OUT BOTH 4 X 4 X 38.88 CORNER POSTS IN A FLAT SURFACE.
- 3: USE A HAMMER TO SEAT THE T-NUTS AFTER INSERTING THEM INTO THE HOLES SHOWN IN THE DIAGRAM BELOW.
- 4: THE BARREL OF THE T-NUTS SHOULD GO IN THE HOLE FIRST. HAMMER THE T-NUT UNTIL IT IS FLUSH/ALMOST FLUSH TO THE CORNER POSTS.

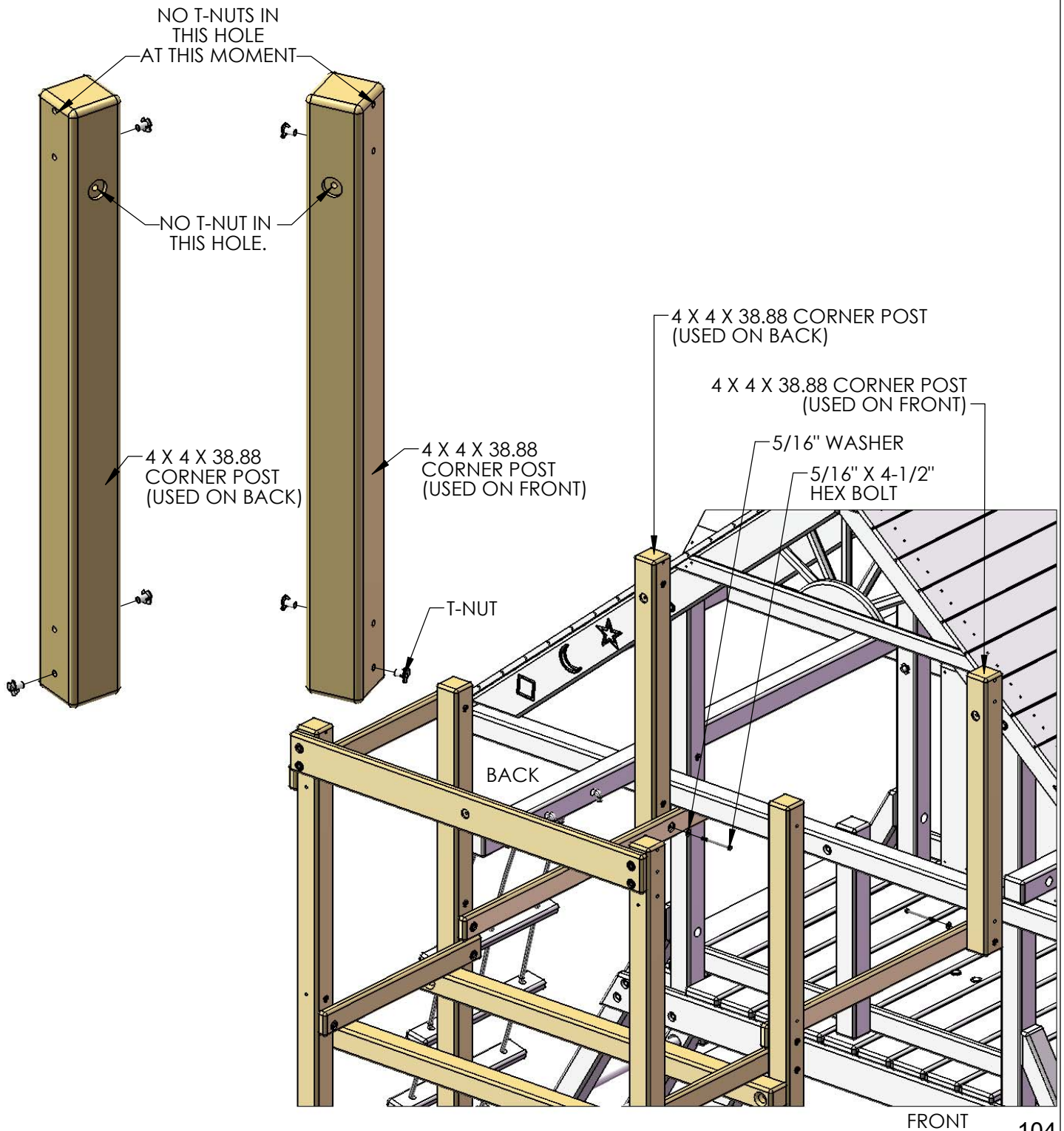

STEP 7: SAFETY BAR

1: LAY THE 2 X 4 X 58.38" SAFETY BAR ON A FLAT SURFACE, USE A HAMMER TO SEAT THE T-NUTS AFTER INSERTING THEM INTO THE HOLES SHOWN IN THE DIAGRAM BELOW. THE BARREL OF THE T-NUTS SHOULD GO IN THE HOLE FIRST. HAMMER THE T-NUT UNTIL IT IS FLUSH/ALMOST FLUSH TO THE SAFETY BAR.

2: PLACE THE 2 X 4 X 58.38" SAFETY BAR ON THE RIGHT SIDE, IN BETWEEN THE CORNER UPPER LEVEL CORNER POSTS AND THE PLAY SET ROOF SUPPORTS, THE ANGLES ENDS SHOULD BE OFFSET UP.

3: FASTEN THE CORNER POSTS TO THE SAFETY BAR USING 5/16" X 4-1/2" HEX BOLTS AND WASHERS THROUGH THE COUNTER SINK HOLES TO THE T-NUTS INSTALLED ON THE SAFETY BAR.

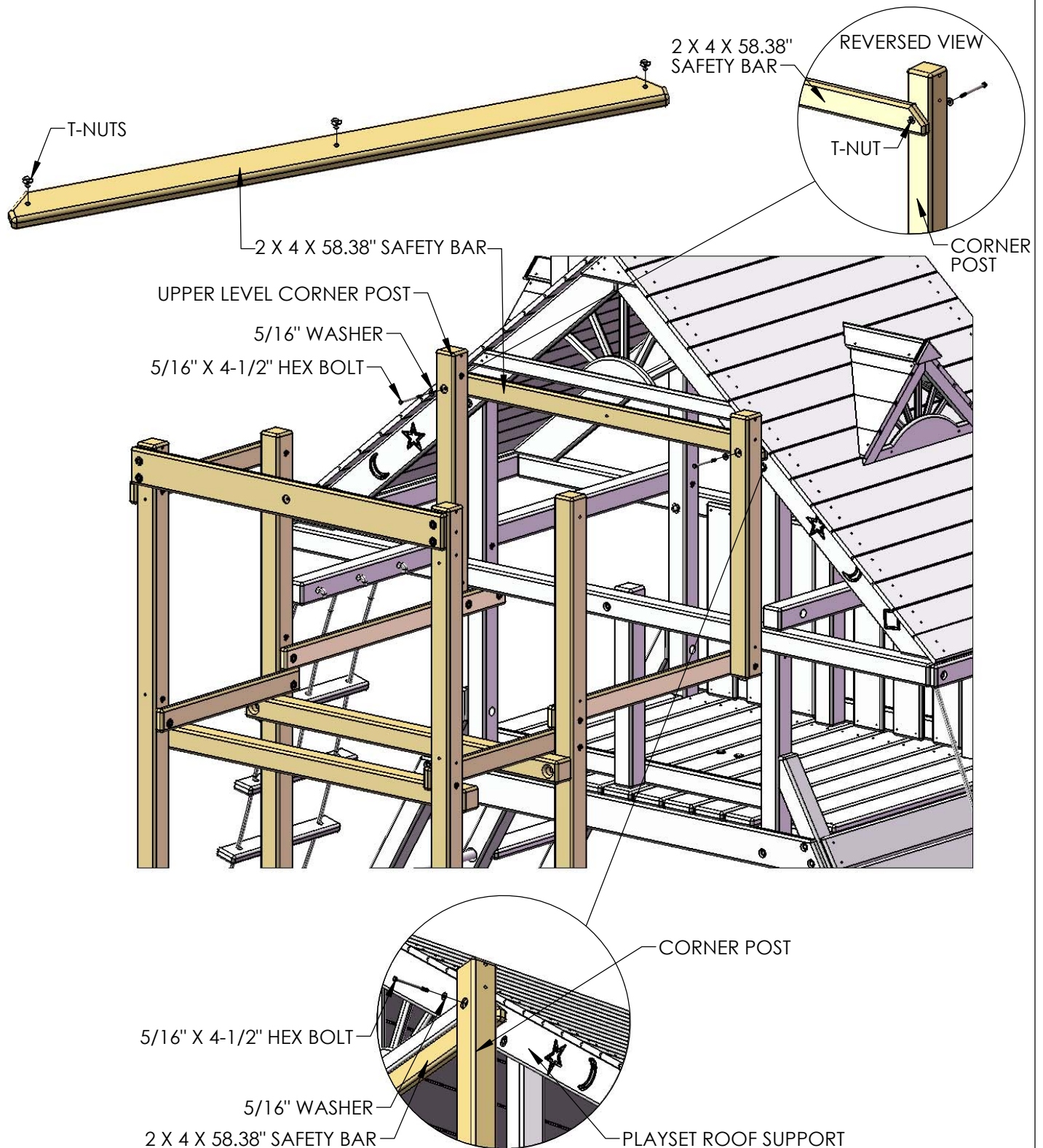

STEP 8: CENTER POST

1: LAY THE 4 X 4 X 45.68" CENTER POST ON A FLAT SURFACE, USE A HAMMER TO SEAT THE T-NUT AFTER INSERTING IT INTO THE HOLE SHOWN IN THE DIAGRAM BELOW. THE BARREL OF THE T-NUT SHOULD GO IN THE HOLE FIRST. HAMMER THE T-NUT UNTIL IS FLUSH/ALMOST FLUSH TO THE SAFETY BAR.

2: PLACE THE 4 X 4 X 45.68" CENTER POST INSIDE AGAINST THE 2 X 6 TOP PANEL BOARD, FASTEN THE CENTER POST TO THE TOP PANEL BOARD CENTER HOLE USING ONE 5/16" X 4-1/2" HEX BOLT AND ONE 5/16" WASHER.

3: MAKE THE DISTANCE BETWEEN CORNER POSTS, AND CENTER POST EQUAL.

4: INSERT A 3/8" X 5" LAG SCREW AND 3/8" WASHER THROUGH THE CENTER POST BOTTOM COUNTER SUNK HOLE INTO THE 4 X 4 DECK SUPPORT.

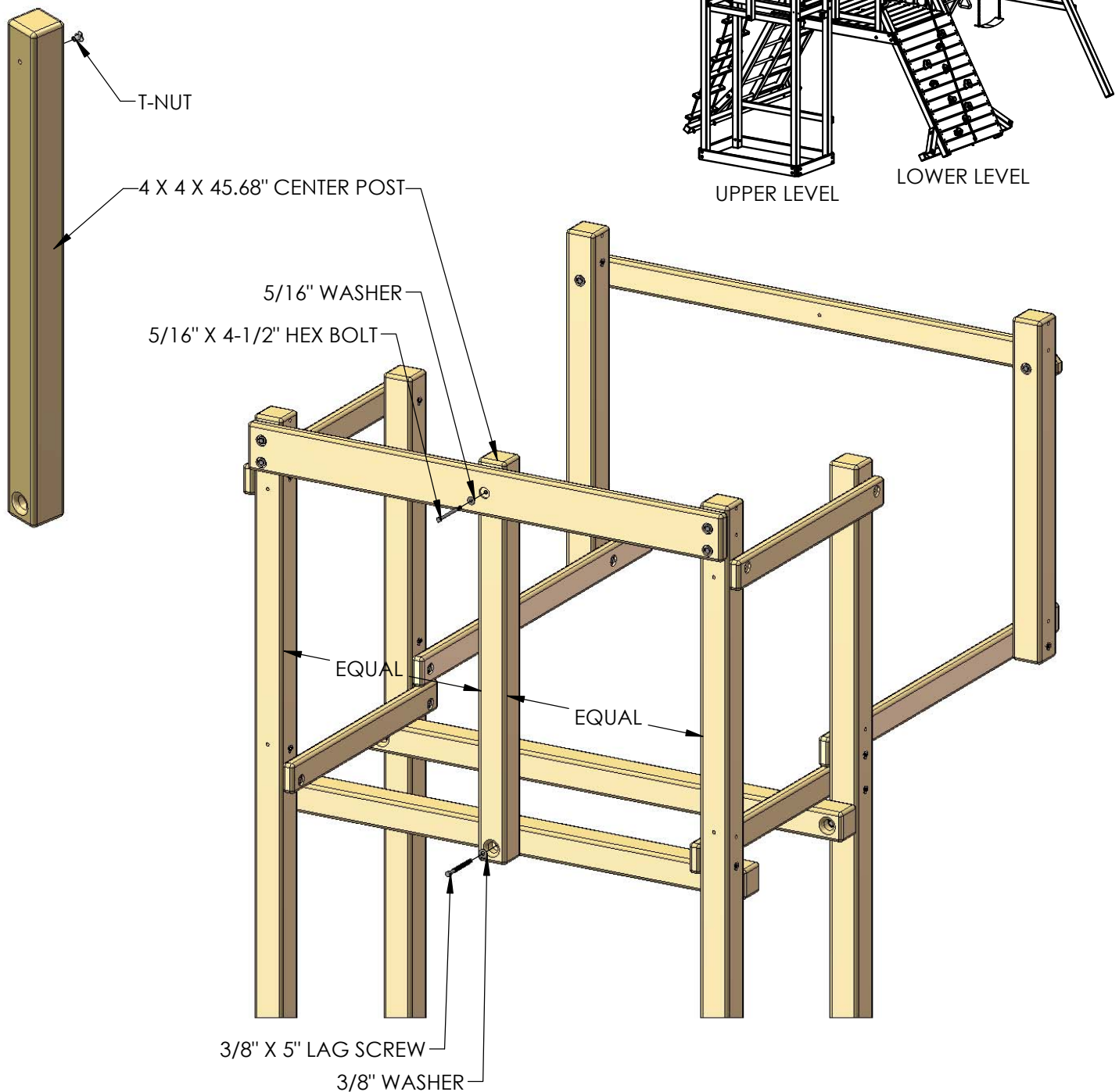

STEP 9: CENTER DECK SUPPORTS

1: PLACE THE THE 4 X 4 X 10.13" CENTER POST AGAINST THE 4 X 4 X 58.38" DECK SUPPORT, MAKING SURE IT IS FLUSH ON THE BOTTOM AND EQUALLY SPACED BETWEEN THE TWO CORNER POSTS. FASTEN USING ONE 3/8" X 5" LAG SCREW AND ONE 3/8" WASHER.

2: MOUNT THE 4 X 4 X 23.88" CENTER DECK SUPPORT ON TOP OF THE DECK SUPPORTS IN BETWEEN THE TWO CENTER POSTS. ATTACH TWO 2 X 4 X 31.00" DECK SUPPORT / PANEL BOARDS ON EACH SIDE OF THE CENTER DECK SUPPORT. THE COUNTERSINK HOLES SHOULD BE OFFSET OPPOSITE TO EACH OTHER. FASTEN TO THE CENTER POSTS USING 5/16" X 3-1/2" LAG SCREWS AND 5/16" WASHERS.

3: FASTEN THE 4 X 4 X 23.88" CENTER DECK SUPPORT WITH TWO #8 X 2-1/2" WOOD SCREWS ON EACH SIDE THROUGH THE 2 X 4 DECK SUPPORTS PREVIOUSLY INSTALLED.

4: FASTEN THE 4 X 4 X 23.88" SLIDE BLOCK TO THE OUTSIDE OF THE DECK SUPPORT USING #8 X 2-1/2" WOOD SCREWS FROM INSIDE THE FORT.

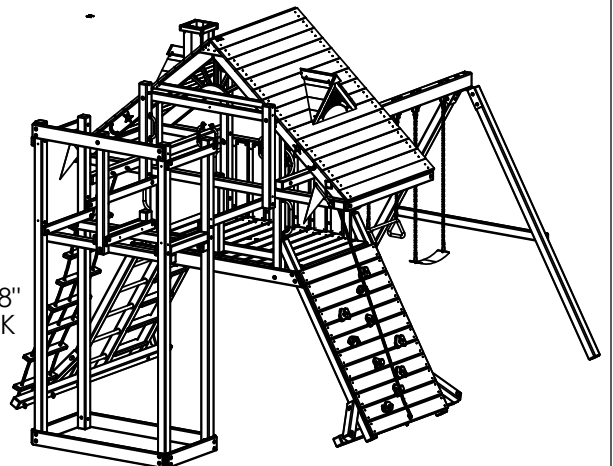
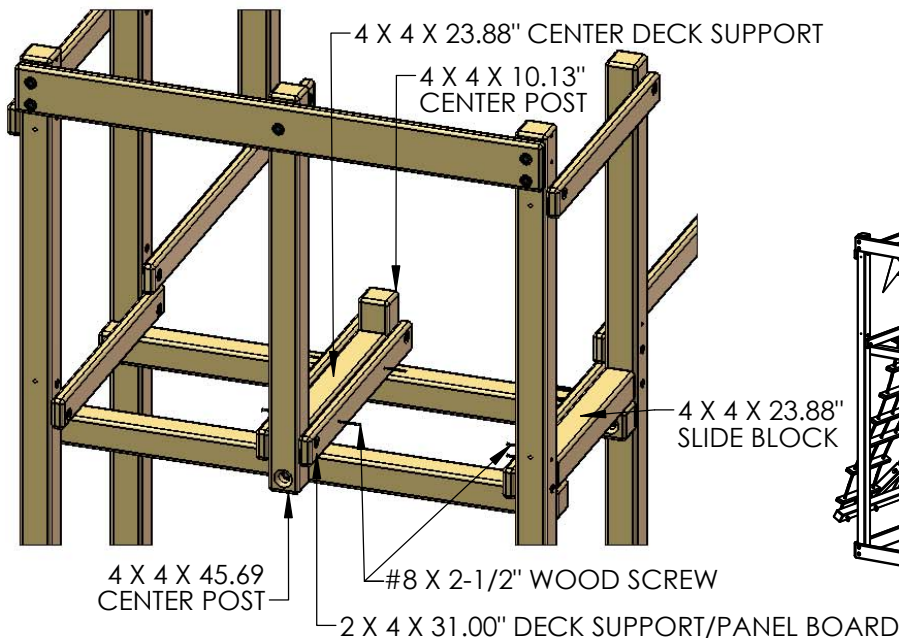
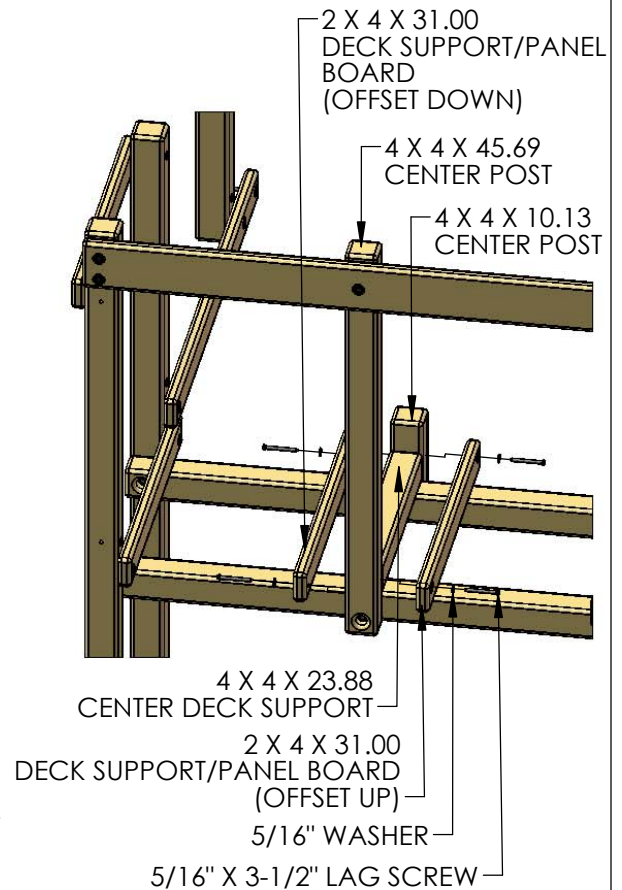
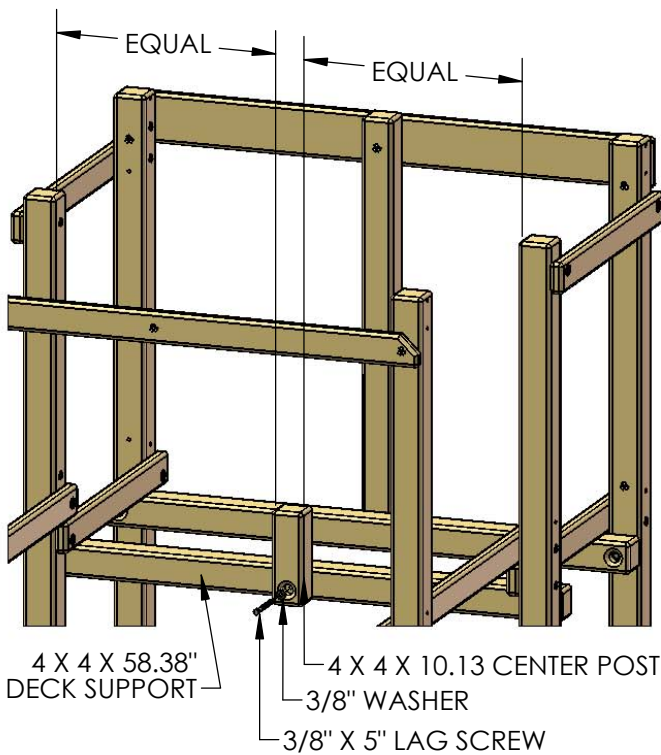

STEP 10: CONNECTING THE CENTER DECK SUPPORT

PLACE THE 2 X 4 X 49.19" CENTER DECK SUPPORT (OFFSET DOWN) AGAINST THE 4 X 4 X 10.13" CENTER POST. THE 10" END SHOWN BELOW SHOULD BE ON TOP OF THE DECK SUPPORT ON THE UPPER LEVEL. THE 10" END SHOULD BE FLUSH TO THE SIDE OF THE 10.13" CENTER POST. THE 16" END SHOULD BE BENEATH THE 4 X 4 PLAY SET SIDE RAIL. THE 16" END SHOULD BE FLUSH TO THE SIDE OF THE PLAY SET CENTER POST. FASTEN THE CENTER DECK SUPPORT TO THE CENTER POSTS WITH 5/16" X 3-1/2" LAG SCREWS AND 5/16" WASHERS.

PLACE THE 2 X 4 X 49.19" CENTER DECK SUPPORT (OFFSET UP) AGAINST THE 4 X 4 X 10.13" CENTER POST. THE 10" END SHOWN BELOW SHOULD BE ON TOP OF THE DECK SUPPORT ON THE UPPER LEVEL. THE 10" END SHOULD BE FLUSH TO THE SIDE OF THE 10.13" CENTER POST. THE 16" END SHOULD BE BENEATH THE 4 X 4 PLAY SET SIDE RAIL. THE 16" END SHOULD BE FLUSH TO THE SIDE OF THE PLAY SET CENTER POST. FASTEN THE CENTER DECK SUPPORT TO THE CENTER POSTS WITH 5/16" X 3-1/2" LAG SCREWS AND 5/16" WASHERS.

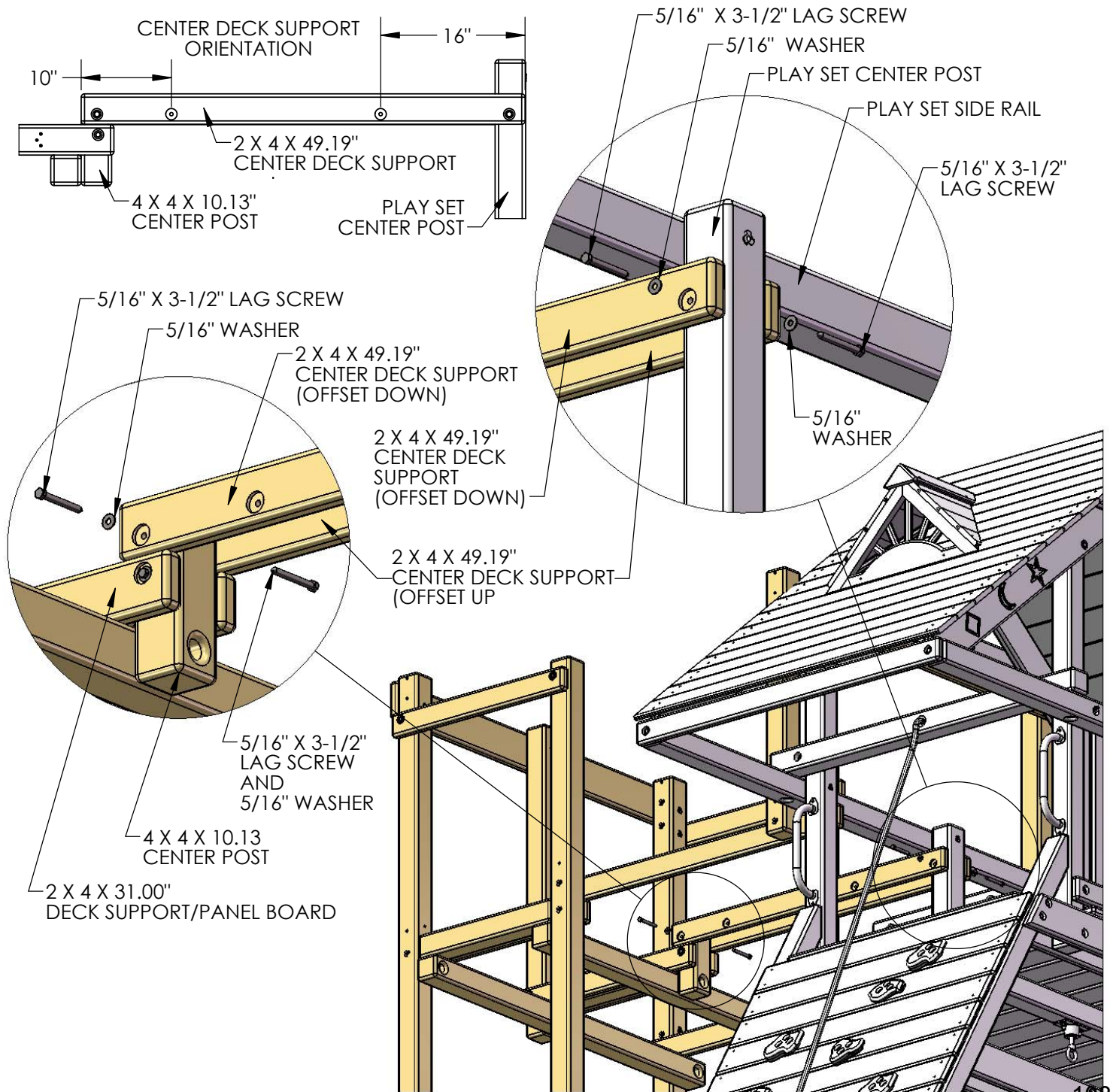

STEP 11: ATTACHING DECK BLOCKS AND DECK SUPPORT

1: INSERT THE 4 X 4 X 21.13" DECK BLOCKS IN BETWEEN THE 2 X 4 CENTER DECK SUPPORTS AND THE 2 X 4 DECK SUPPORTS, UNDERNEATH THE PLAY SET SIDE RAIL. MAKE SURE THE C-BORE HOLES ARE FACING DOWN AND FASTEN TO THE SIDE RAIL USING 3/8" X 5" LAG SCREWS AND 3/8" WASHERS.

2: MOUNT THE 4 X 4 X 58.38" DECK SUPPORT FLUSH UNDERNEATH THE DECK BLOCKS. MAKE SURE THE C-BORE HOLES ARE FACING TOWARDS YOU AND FASTEN TO THE PLAY SET CORNER POSTS USING 3/8" X 5" LAG SCREWS AND 3/8" WASHERS.

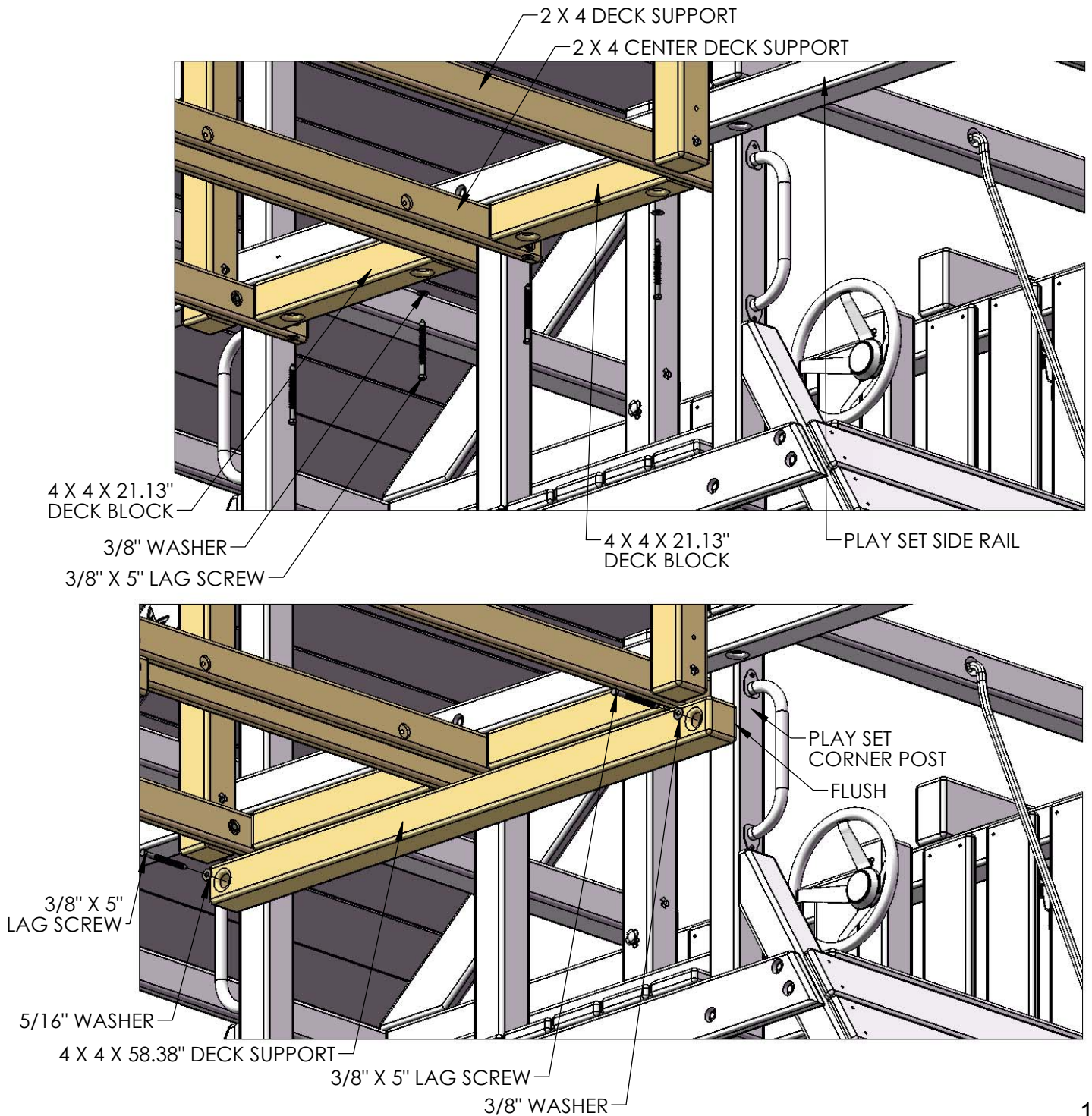

STEP 12: CENTER POST AND CENTER DECK SUPPORT

1: MOUNT THE 4 X 4 X 42.28" CENTER POST IN BETWEEN THE TWO 2 X 4 CENTER DECK SUPPORTS AGAINST THE SAFETY BAR AND THE 4 X 4 DECK SUPPORT. THE COUNTERSUNK HOLE (WITH NO ROUNDED EDGES) SHOULD BE AT THE TOP AND THE DEEP C-BORE HOLE (WITH ROUNDED EDGES) SHOULD BE AT THE BOTTOM. USE A 5/16" X 4-1/2" HEX BOLT AND 5/16" WASHER TO ATTACH THE TOP COUNTERSUNK HOLE OF THE CENTER POST TO THE T-NUT INSTALLED IN THE SAFETY BAR.

2: USE A 3/8" X 5" LAG SCREW AND 3/8" WASHER TO ATTACH THE BOTTOM (DEEP C-BORE) HOLE TO THE 4 X 4 DECK SUPPORT.

3: INSERT THE 4 X 4 X 35.13" CENTER DECK SUPPORT IN BETWEEN THE TWO 2 X 4 CENTER DECK SUPPORTS PREVIOUSLY INSTALLED.

MAKE SURE THE SET OF HOLES LOCATED ON THE CENTER ARE EXPOSED AS SHOWN IN THE DIAGRAM BELOW. FASTEN THE CENTER DECK SUPPORT USING 5/16" X 3-1/2" LAG SCREWS AND 5/16" WASHERS THROUGH THE SET OF COUNTERSINK HOLES LOCATED ON THE 2 X 4 CENTER DECK SUPPORTS.

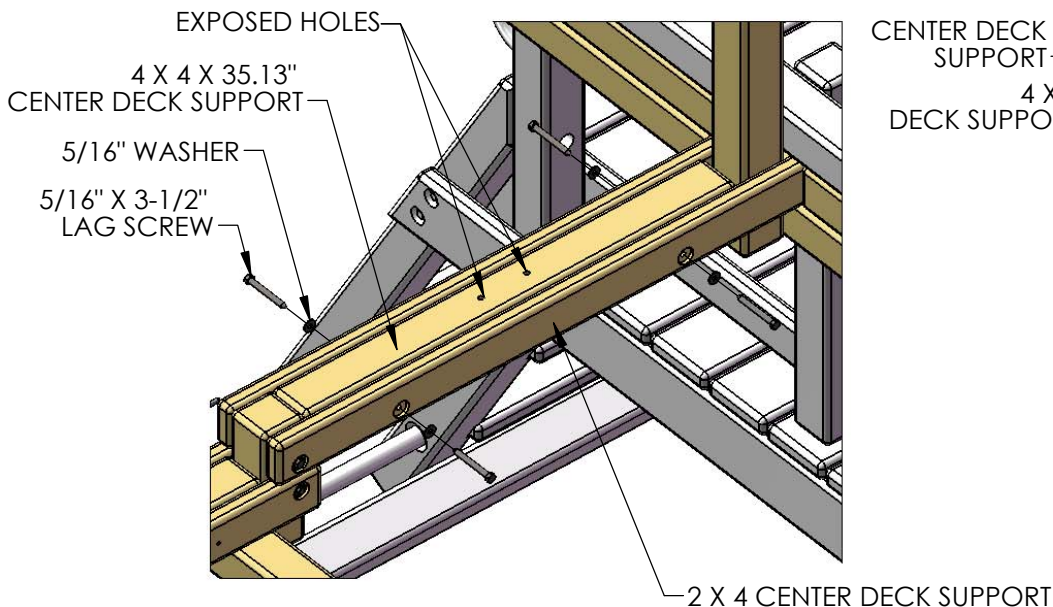
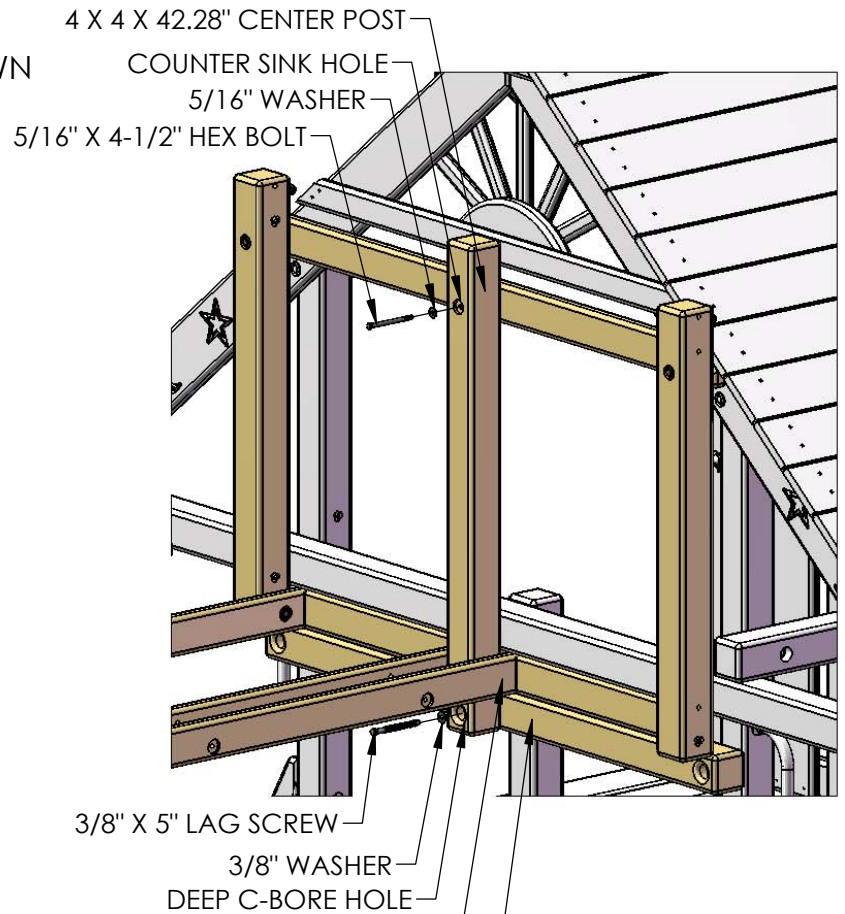

STEP 13: IRON DUCTILE

1: LINE UP THE HOLES OF THE IRON DUCTILE WITH THE HOLES IN THE CENTER DECK SUPPORT, THE IRON DUCTILE WILL BE ON THE BOTTOM.

2: FASTEN THE IRON DUCTILE TO THE SWING BEAM USING 3/8" X 4-1/2" CARRIAGE BOLTS WITH TORQUE WASHERS, AND 3/8" WASHERS WITH 3/8" LOCK NUTS.

3: PLACE BOLT CAPS OVER EXPOSED THREADS.

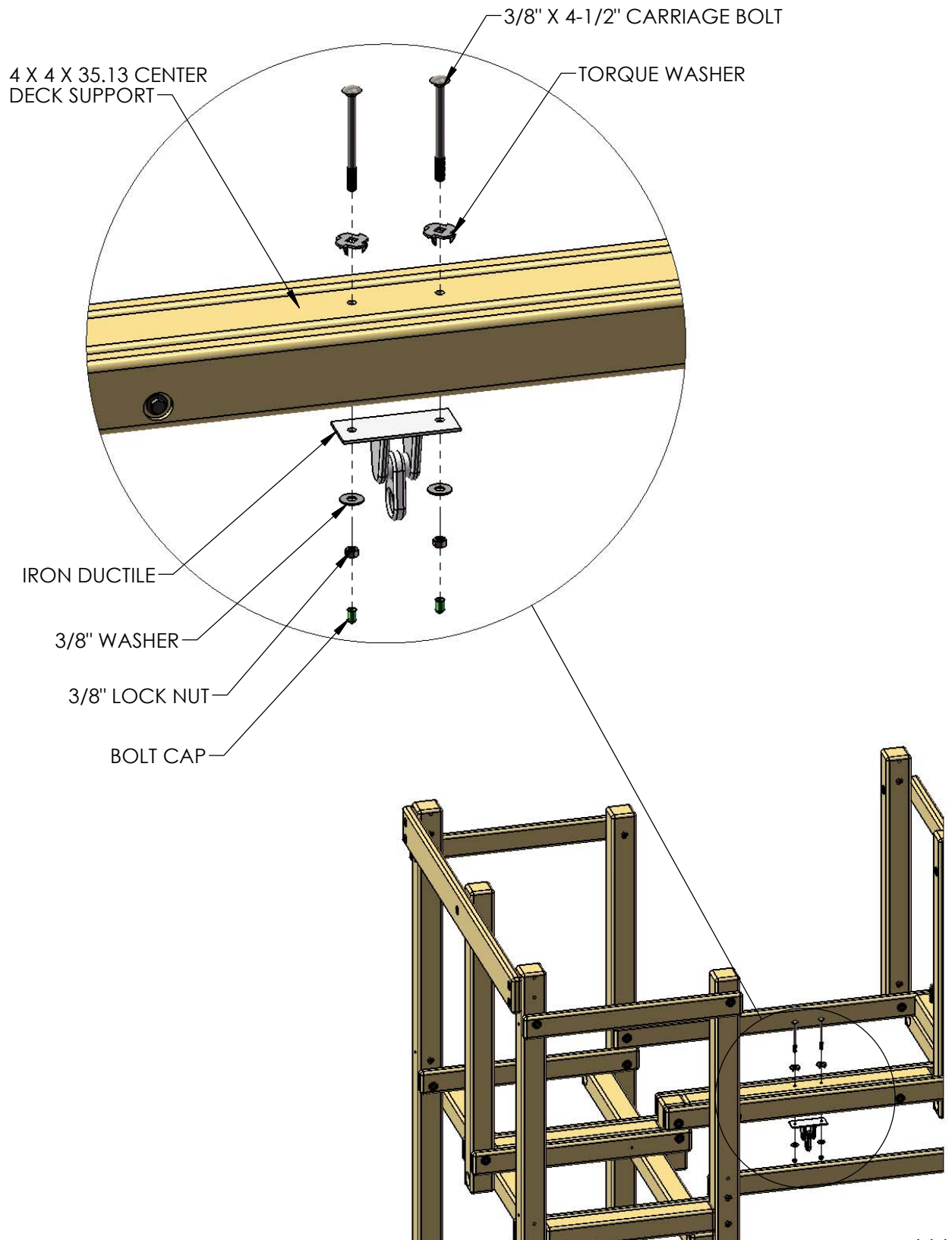

STEP 14: TOP AND BOTTOM PANEL BOARDS

1: PLACE THE 2 X 4 X 70.00" TOP PANEL BOARD ON THE TOP LOWER HOLES ON THE CORNER POSTS. USE 5/16" X 4-1/2" HEX BOLTS AND 5/16" WASHERS TO ATTACH THE END HOLES OF THE TOP PANEL BOARD TO THE T-NUTS INSTALLED IN THE CORNER POSTS. THE CENTER HOLE WILL BE USED LATER.

2: INSERT TWO #8 X 2-1/2" WOOD SCREWS THROUGH THE TOP PANEL BOARD INTO THE MIDDLE POST.

3: REPEAT SUB-STEP 1 AND 2 FOR THE OPPOSITE SIDE.

4: FASTEN THE 2 X 4 X 42.50" BOTTOM PANEL BOARD TO THE HOLE LOCATED AT THE BOTTOM OF THE CORNER POSTS. USE 5/16" X 4-1/2" HEX BOLTS AND 5/16" WASHERS TO ATTACH THE HOLES OF THE BOTTOM PANEL BOARD TO THE T-NUTS INSTALLED IN THE CORNER AND MIDDLE POSTS.

5: REPEAT SUB-STEP 4 FOR THE OPPOSITE SIDE.

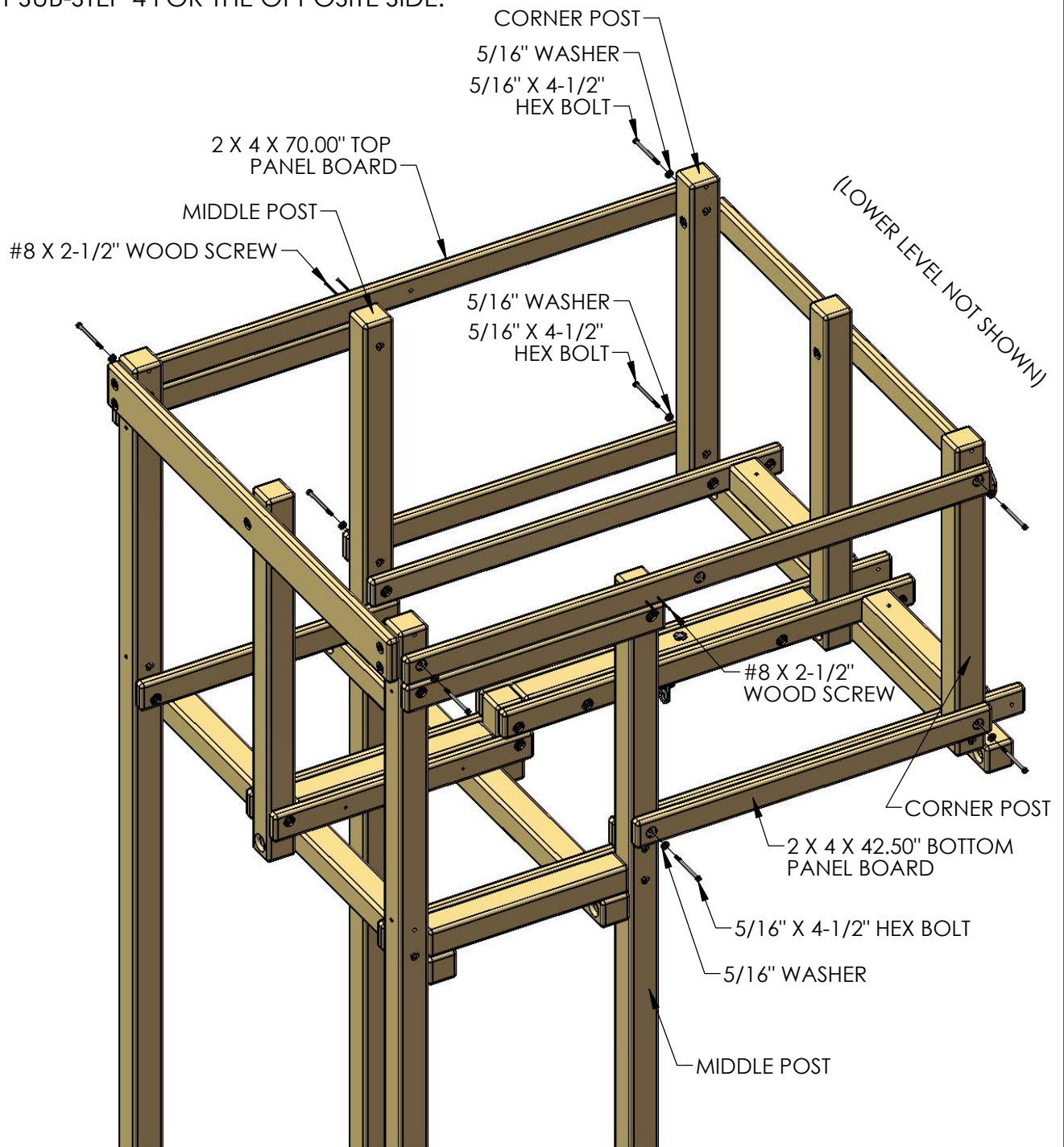

STEP 15: DECK FILLER, DECK SPACERS AND DECK BOARDS

1: CENTER THE 5/4 X 4 X 58.13" DECK FILLER ABOVE THE DECK SUPPORTS, FLAT AGAINST THE MIDDLE POSTS AND CENTER POST. FASTEN USING #8 X 2" WOOD SCREWS THROUGH THE PREDRILLED HOLES INTO THE MIDDLE POSTS AND CENTER POST AS SHOWN BELOW.

2: PLACE THE 5/4 X 4 X 23.88" DECK SPACER CENTERED BETWEEN THE CENTER POSTS AND THE CORNER POSTS AND ATTACH USING #8 X 2" WOOD SCREWS THROUGH THE PREDRILLED HOLES INTO THE DECK SUPPORTS BELOW. NOTE: THE TOP OF THE SCREW HEAD SHOULD BE FLUSH TO THE TOP OF THE DECK SPACER.

3: PLACE THE 5/4 X 4 X 51.25" DECK SPACER CENTERED BETWEEN THE MIDDLE POSTS AND ATTACH USING #8 X 2" WOOD SCREWS THROUGH THE PREDRILLED HOLES INTO THE DECK SUPPORTS BELOW. NOTE: THE TOP OF THE SCREW HEAD SHOULD BE FLUSH TO THE TOP OF THE DECK SPACER.

4: PLACE A 5/4 X 6 X 58.13" DECK BOARD AT ONE END OF THE FORT. CENTER THE DECK BOARD BETWEEN THE BOTTOM PANEL BOARDS AND ATTACH IT WITH #8 X 2" WOOD SCREWS THROUGH THE PREDRILLED HOLES INTO THE DECK SUPPORTS BELOW. LEAVE A UNIFORM SPACE BETWEEN THE DECK BOARDS. NOTE: THE TOP OF THE SCREW HEAD SHOULD BE FLUSH TO THE TOP OF THE DECK BOARDS.

LAY ALL THE DECK BOARDS ACROSS THE DECK SUPPORTS BEFORE SECURING THEM TO THE FORT. THIS WILL ENSURE THAT YOU HAVE EQUAL SPACING ACROSS THE DECK.

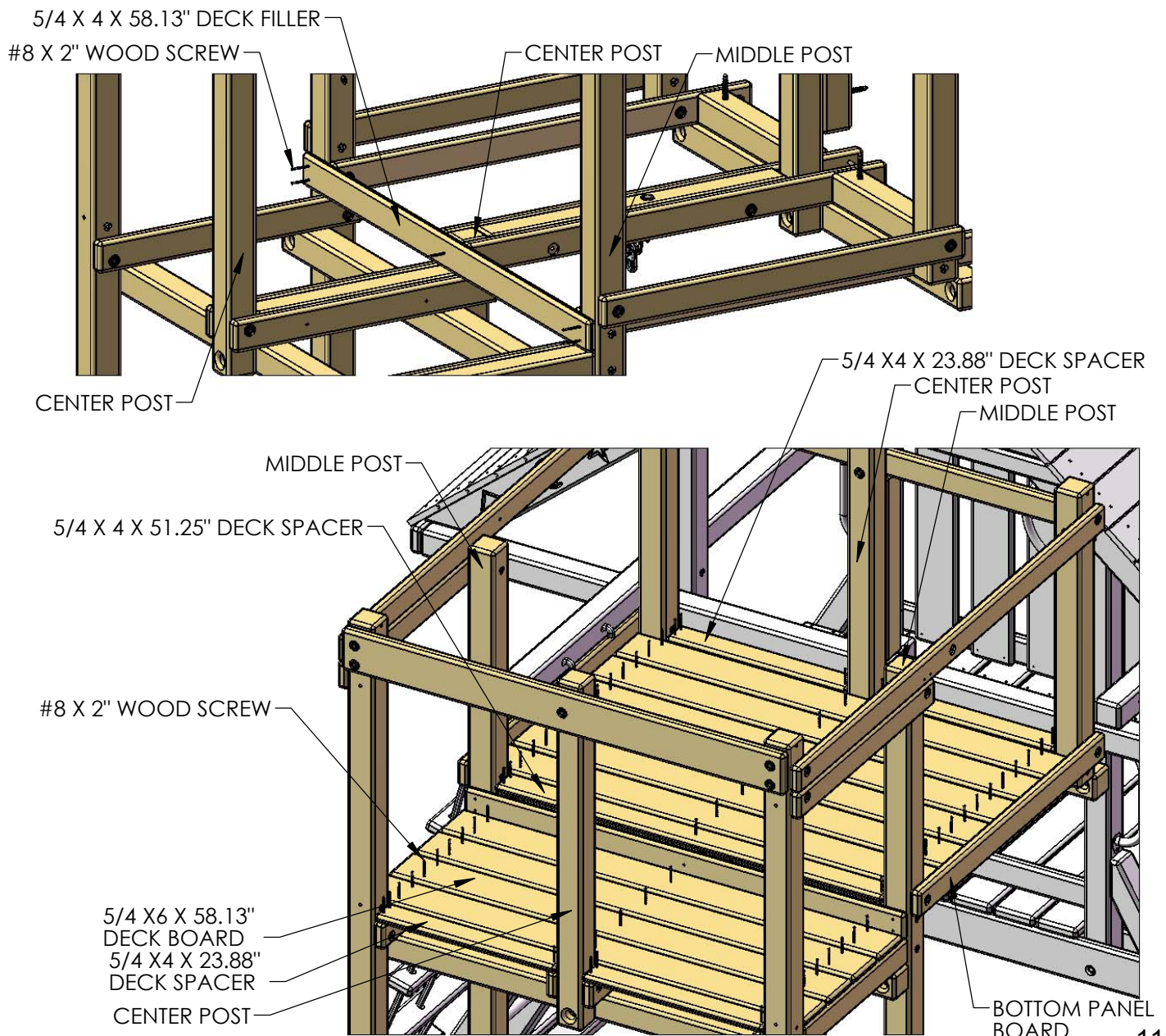

STEP 16: ANGLE SUPPORTS

1: FIND SIX 2 X 4 X 18.00" ANGLE SUPPORTS AND MOUNT THEM UNDER THE DECK ON THE FRONT, REAR AND SIDES OF THE FORT. **THE TOP OF THE ANGLE SUPPORTS SHOULD BE FLUSH OR LOWER THAN THE BOTTOM OF THE DECK BOARDS.** AT THE TOP USE 2-1/2" WOOD SCREWS THROUGH THE ANGLE SUPPORTS INTO THE DECK SUPPORTS. AT THE BOTTOM USE ONE 2" AND ONE 3" WOOD SCREW TO FASTEN THE ANGLE SUPPORT TO THE CORNER POST OR MIDDLE POST.

2: FIND TWO 2 X 4 X 21.50" ANGLE SUPPORTS AND MOUNT THEM UNDER THE DECK BOARDS (THE TOP OF THE ANGLE SUPPORT SHOULD BE FLUSH OR LOWER THAN THE BOTTOM OF THE DECK BOARD) ON ONE SIDE, AND UNDER THE SLIDE BLOCK (THE TOP OF THE ANGLE SUPPORT SHOULD BE FLUSH TO THE BOTTOM OF THE SLIDE BLOCK) ON THE OTHER SIDE. AT THE TOP USE 2-1/2" WOOD SCREWS THROUGH THE DECK SUPPORT INTO THE ANGLE SUPPORT ON ONE SIDE AND ONE 2" AND ONE 3" WOOD SCREW TO FASTEN THE TOP OF THE ANGLE SUPPORT TO THE SLIDE BLOCK ON THE OTHER SIDE. AT THE BOTTOM USE ONE 2" AND ONE 3" WOOD SCREW TO FASTEN THE ANGLE SUPPORT TO THE CORNER POSTS. FOLLOW THE DIAGRAM BELOW TO IDENTIFY THE ANGLE SUPPORTS.

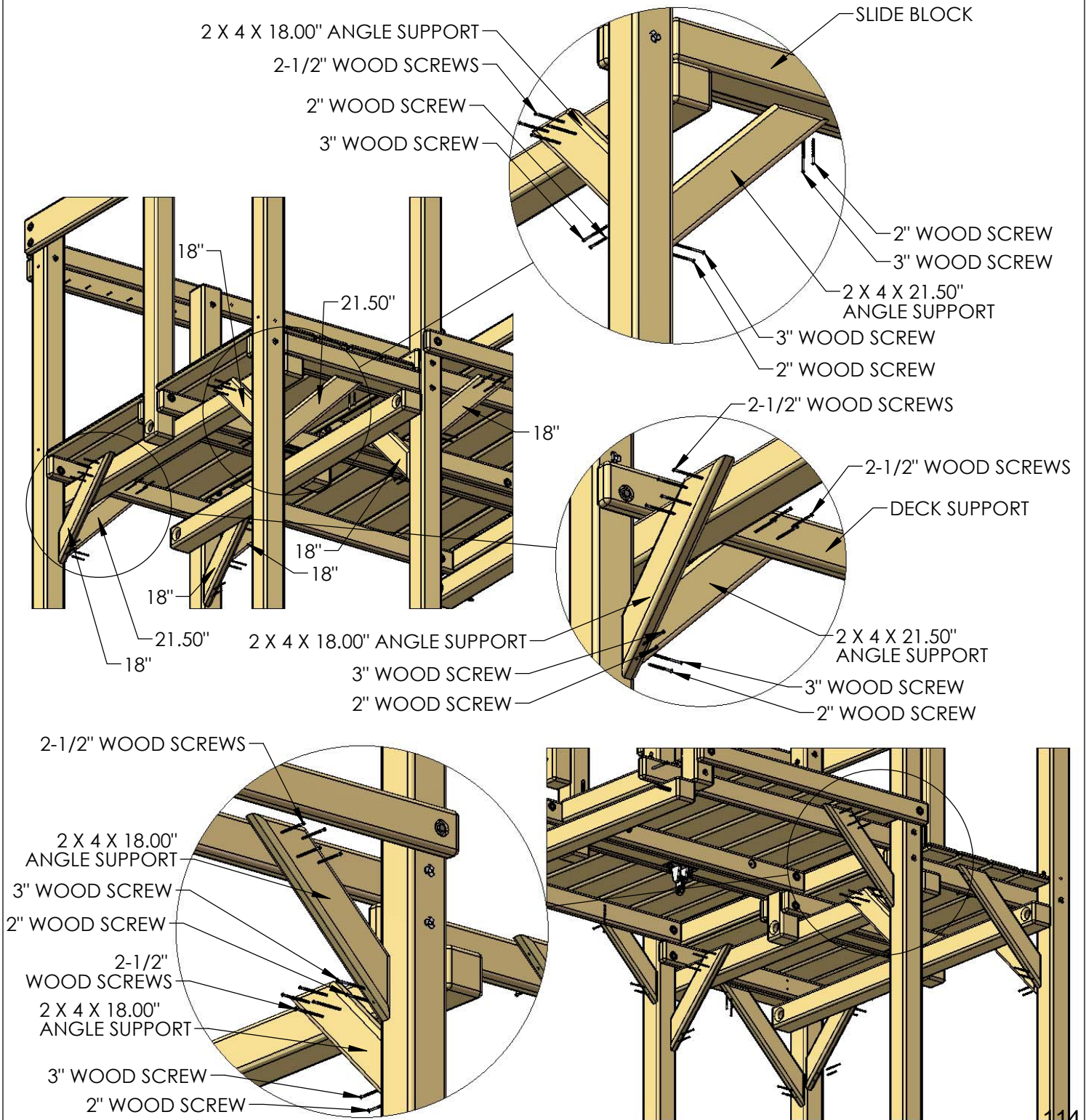

STEP 18: LADDER

1: FIND FOUR 2 X 4 X 27.55" LADDER SIDES.

2: POSITION THE LADDER SIDES SO THAT THE SLOTS IN THE BOARDS ARE FACING EACH OTHER AND ARE PARALLEL.

3: INSERT T-NUTS INTO THE OUTSIDE OF THE LADDER SIDES AND SET WITH A HAMMER.

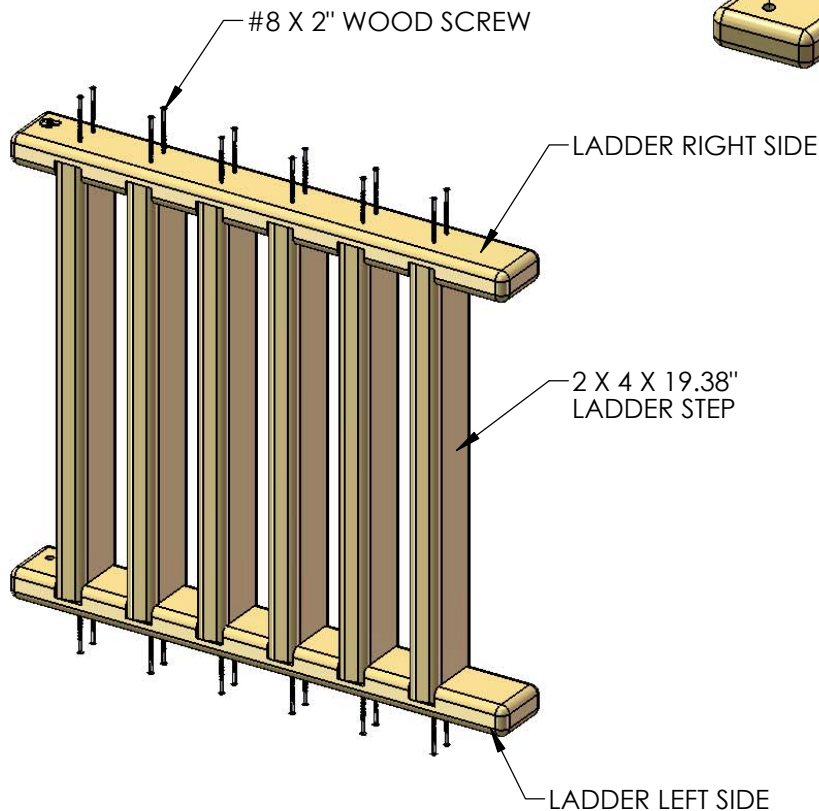
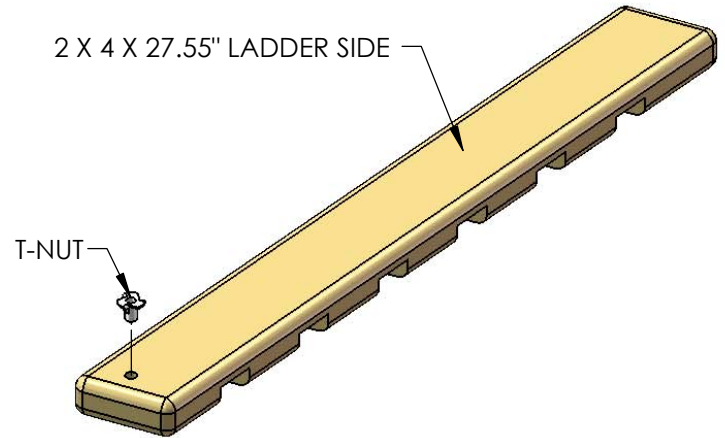

4: FIND TWELVE 2 X 4 X 19.38" LADDER STEPS.

5: PLACE THE STEPS INTO THE SLOTS ON THE LADDER SIDES, AND FASTEN WITH #8 X 2" WOOD SCREWS.

6: CAREFULLY TURN THE LADDER OVER AND PUT THE SCREWS INTO THE OTHER SIDE.

7: INSTALL THE 90° ANGLE BRACKETS TO THE INSIDE OF THE LADDER RAILS WITH 5/16" X 1-1/2" BOLTS AND 5/16" WASHERS, INTO THE 5/16" T-NUTS.

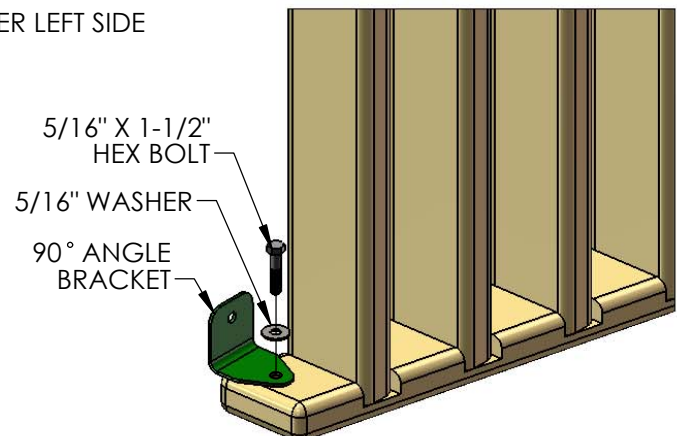

STEP 19: LADDER TO FORT

1: PLACE THE LADDERS INTO POSITION ON TOP OF THE LOWER LEVEL DECK RESTING AGAINST THE DECK BLOCKS BELOW THE SIDE RAIL. ATTACH USING #14 X 1" PAN HEAD SCREWS AND 1/4" WASHERS THROUGH THE HOLES IN THE LADDER BRACKETS INTO THE DECK BLOCKS.

2: UNDERNEATH THE DECK ATTACH THE DECK BOARDS TO EACH LADDER SIDE WITH #8 X 2-1/2" WOOD SCREWS.

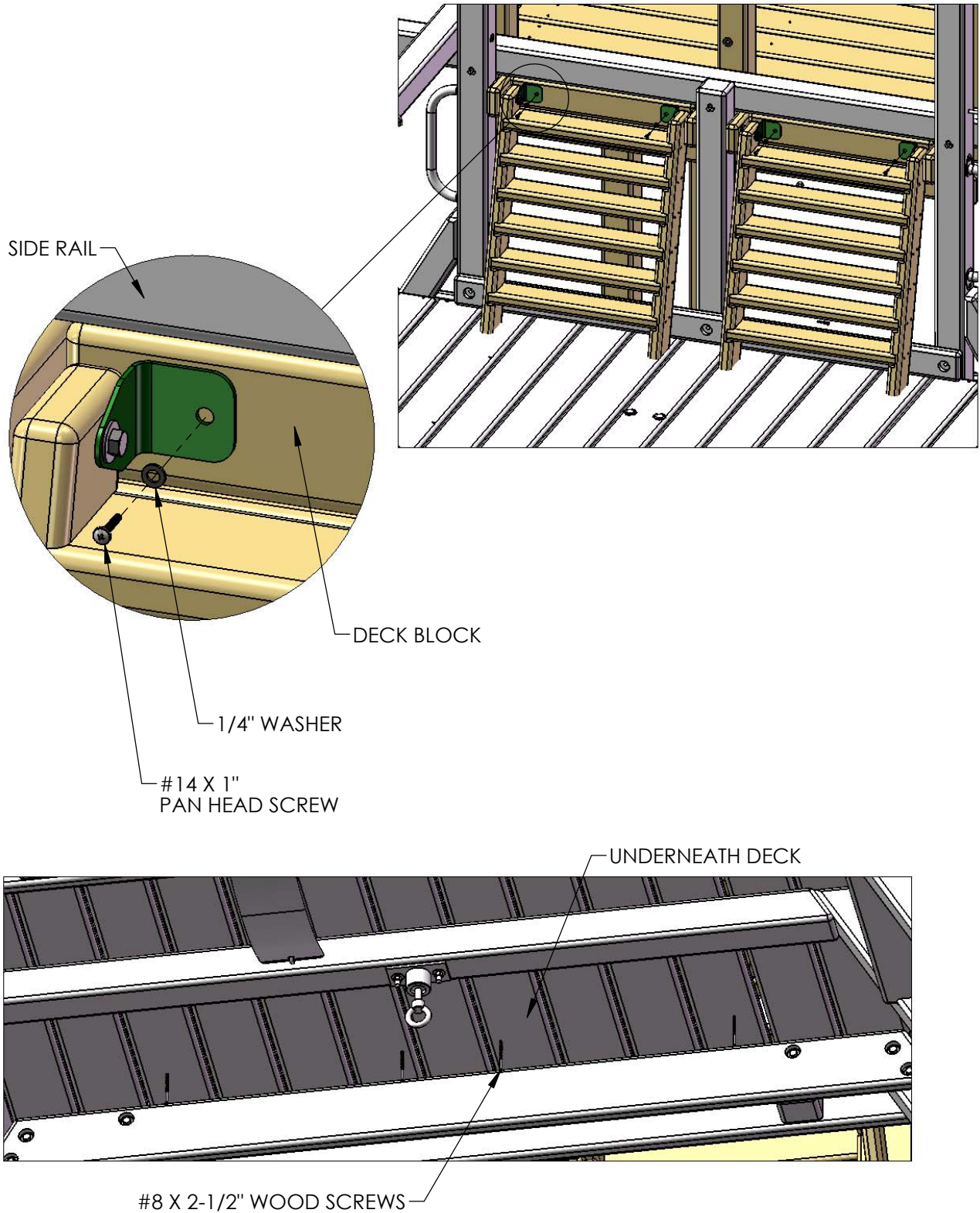

STEP 20: CENTER POSTS AND BOTTOM PANEL BOARD

1: PLACE THE 2 X 4 X 42.50" BOTTOM PANEL BOARD ABOVE THE ROPE LADDER SUPPORT, CENTERED BETWEEN THE CORNER POST AND THE MIDDLE POST. USE 5/16" X 3-1/2" LAG SCREWS AND 5/16" WASHERS TO ATTACH THE BOTTOM PANEL BOARD TO THE POSTS.

2: HAMMER A T-NUT INTO THE HOLE OF THE 2 X 4 X 68.00" CENTER POST PLACE IT INSIDE THE FORT ON TOP OF THE DECK, MAKE SURE THE SET OF SMALL PREDRILLED HOLES ARE ON THE BOTTOM. LINE UP THE CENTER HOLE OF THE CENTER POST WITH THE CENTER HOLE OF THE TOP PANEL BOARD, USE A 5/16" X 2-1/2" HEX BOLT TO ATTACH THE CENTER HOLE OF THE TOP PANEL BOARD TO THE T-NUT INSTALLED IN THE CENTER POST.

3: SQUARE THE CENTER POST TO THE DECK AND SECURE THE BOTTOM OF THE CENTER POST TO THE BOTTOM PANEL BOARD WITH #8 X 2-1/2" WOOD SCREWS THROUGH THE PREDRILLED HOLES.

4: REPEAT SUB STEPS 2 AND 3 FOR THE OTHER SIDE.

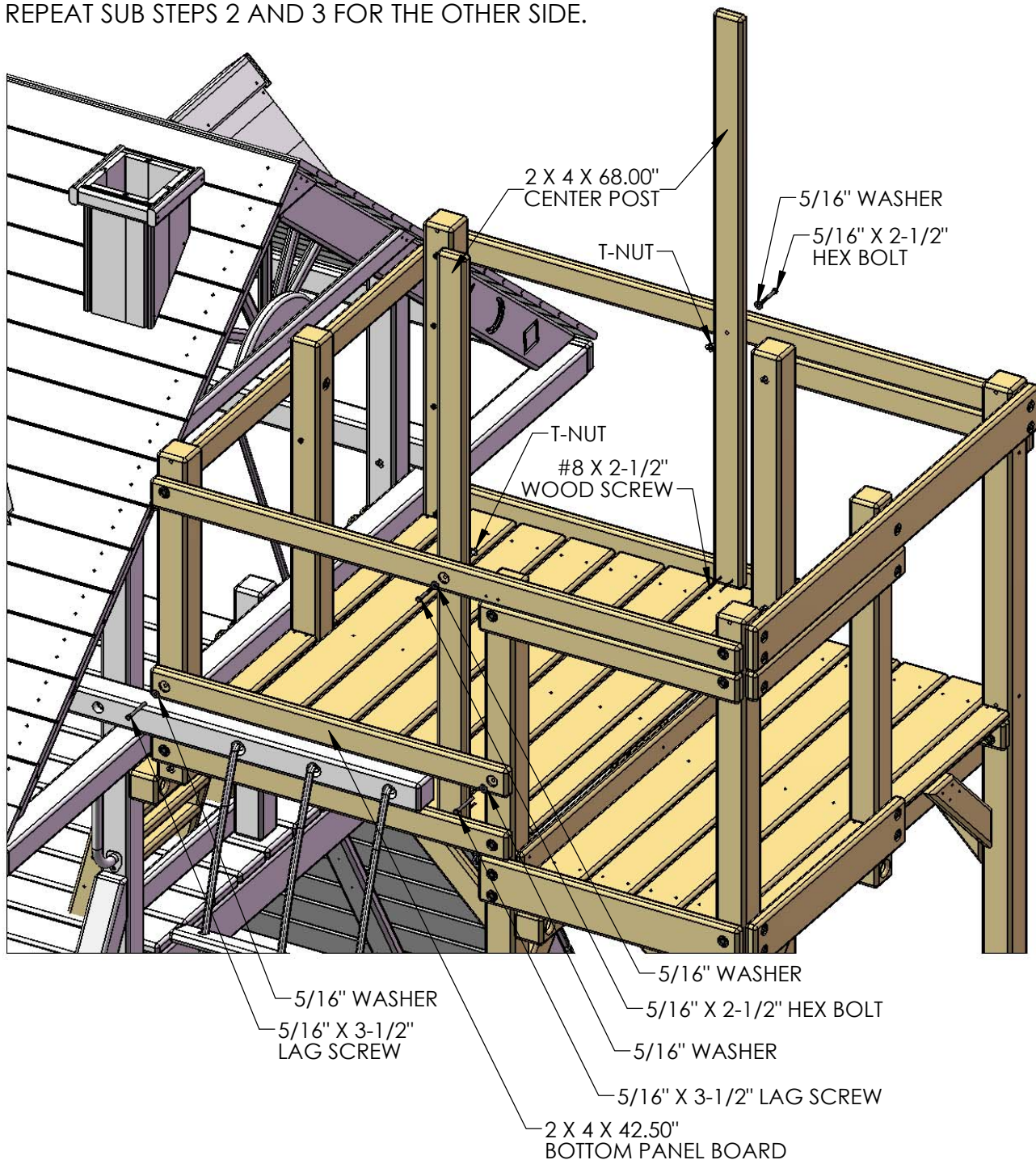

STEP 21: PANEL SLATS

1: FIND SIX 5/4 X 6 X 30.50" PANEL SLATS.

2: INSTALL THE PANEL SLATS AT EQUAL LENGTHS. SEE DETAIL BELOW FOR MEASUREMENTS.

3: ATTACH THE PANEL SLATS TO THE TOP AND BOTTOM PANEL BOARDS WITH #8 X 2" WOOD SCREWS THROUGH THE PREDRILLED HOLES.

REAR AND SIDE PANEL SLAT SPACING SLAT DIMENSIONS (VIEW FROM OUTSIDE THE PLAYSET)

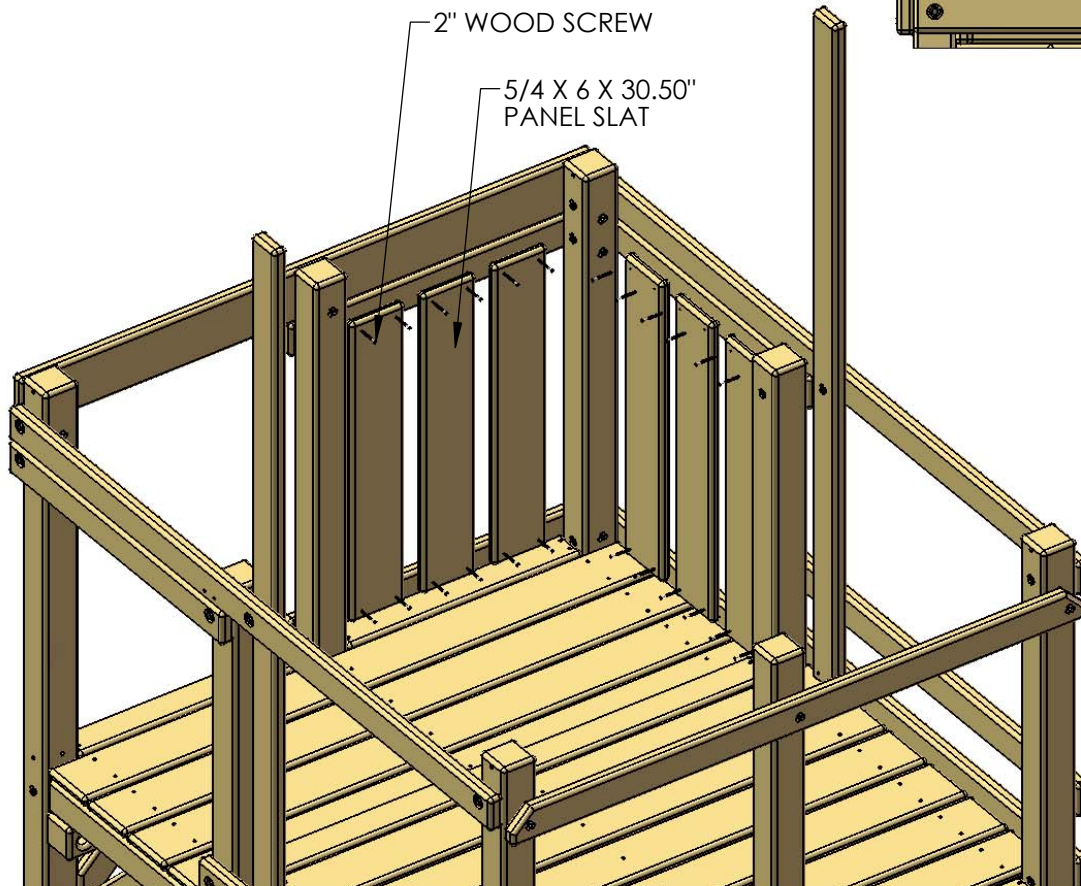
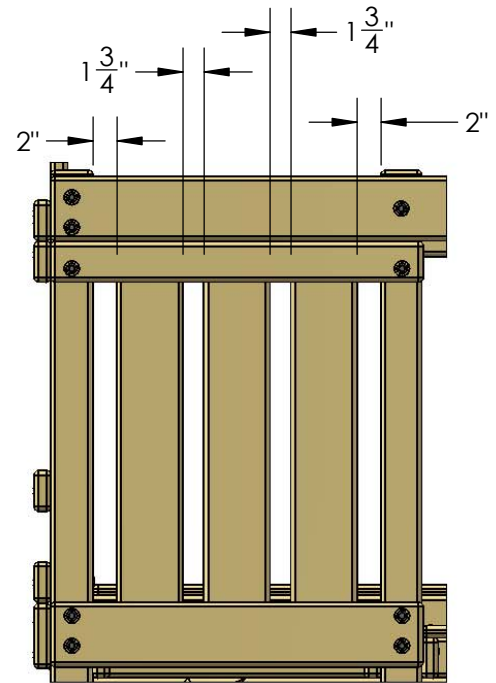

STEP 22: PANEL SLATS

1: FIND FOUR 5/4 X 6 X 30.50" PANEL SLATS AND PLACE THEM AT THE FRONT OF THE FORT AGAINST THE TOP AND BOTTOM PANEL BOARDS. ATTACH WITH #8 X 2" WOOD SCREWS.

2: FIND FOUR 5/4 X 6 X 26.00" PANEL SLATS AND PLACE THEM AT THE REAR OF THE FORT AGAINST THE TOP AND BOTTOM PANEL BOARD LOCATED ABOVE THE ROPE LADDER SUPPORT. ATTACH WITH #8 X 2" WOOD SCREWS.

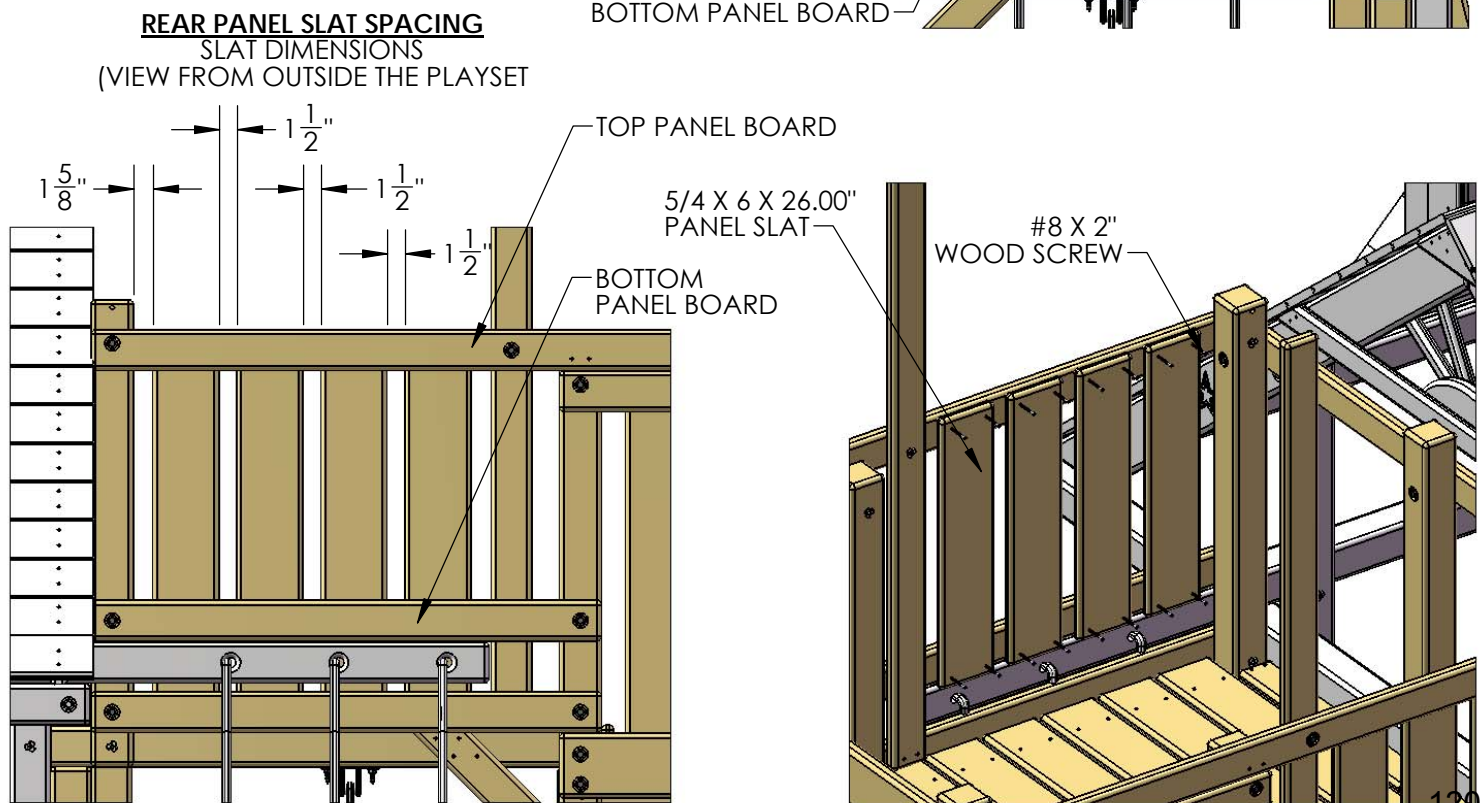
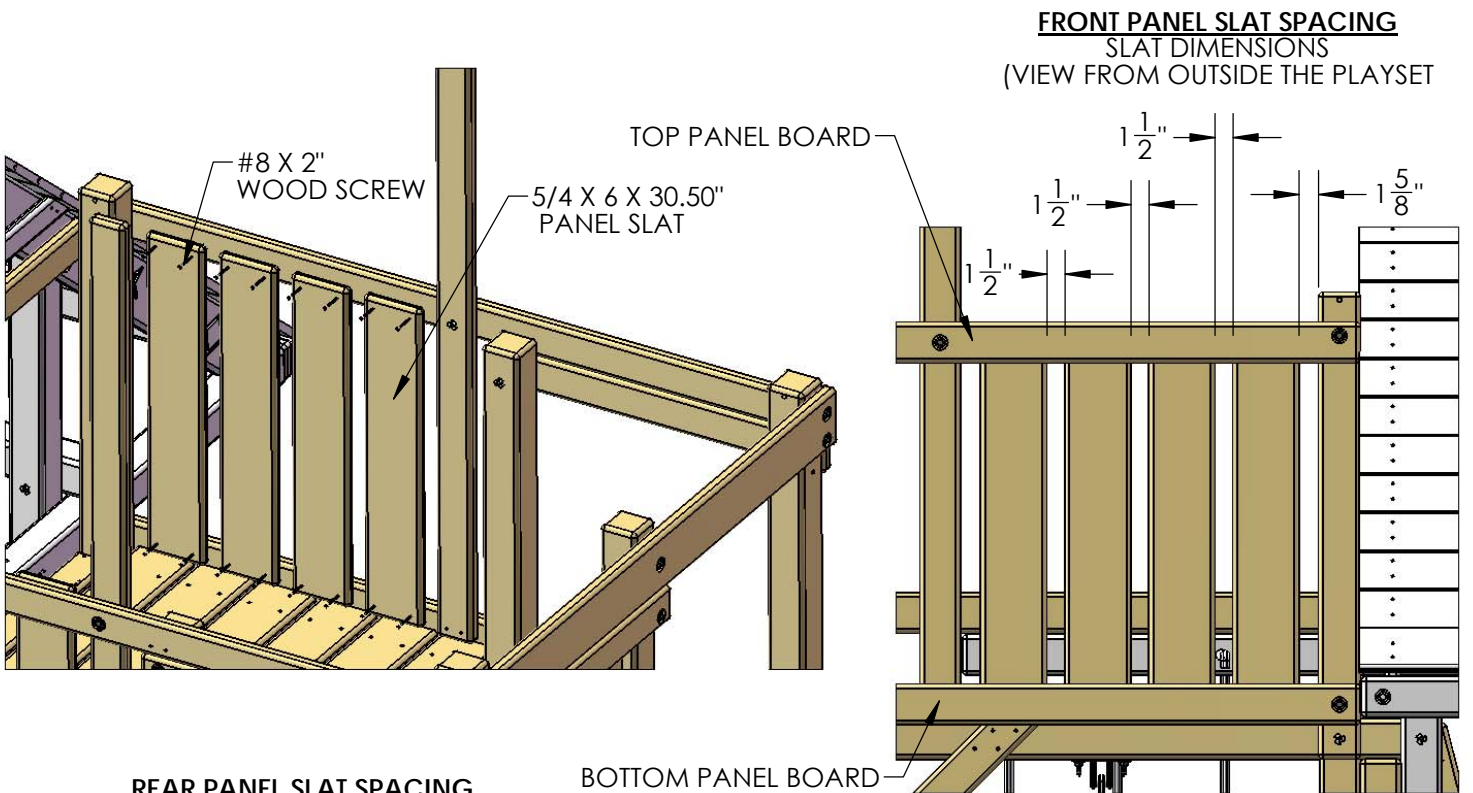

STEP 23: SANDBOX SEATS AND SAFETY BAR

1: MEASURE 24" FROM THE BOTTOM OF THE CORNER POSTS ON THE RIGHT SIDE OF THE FORT. MARK THESE POSITIONS ON THE OUTSIDE OF THE MIDDLE POSTS. ATTACH THE 2 X 4 X 58.38" SANDBOX SAFETY BAR TO THE MIDDLE POSTS WITH 5/16" X 3-1/2" LAG SCREWS AND 5/16" WASHERS.

2: PLACE THE 5/4 X 6 X 22.00" SANDBOX SEATS ONTO THE TOP OF THE SANDBOX BOARDS AS SHOWN BELOW.

3: ATTACH THE SANDBOX SEATS TO THE SANDBOX BOARDS WITH #8 X 2" WOOD SCREWS.

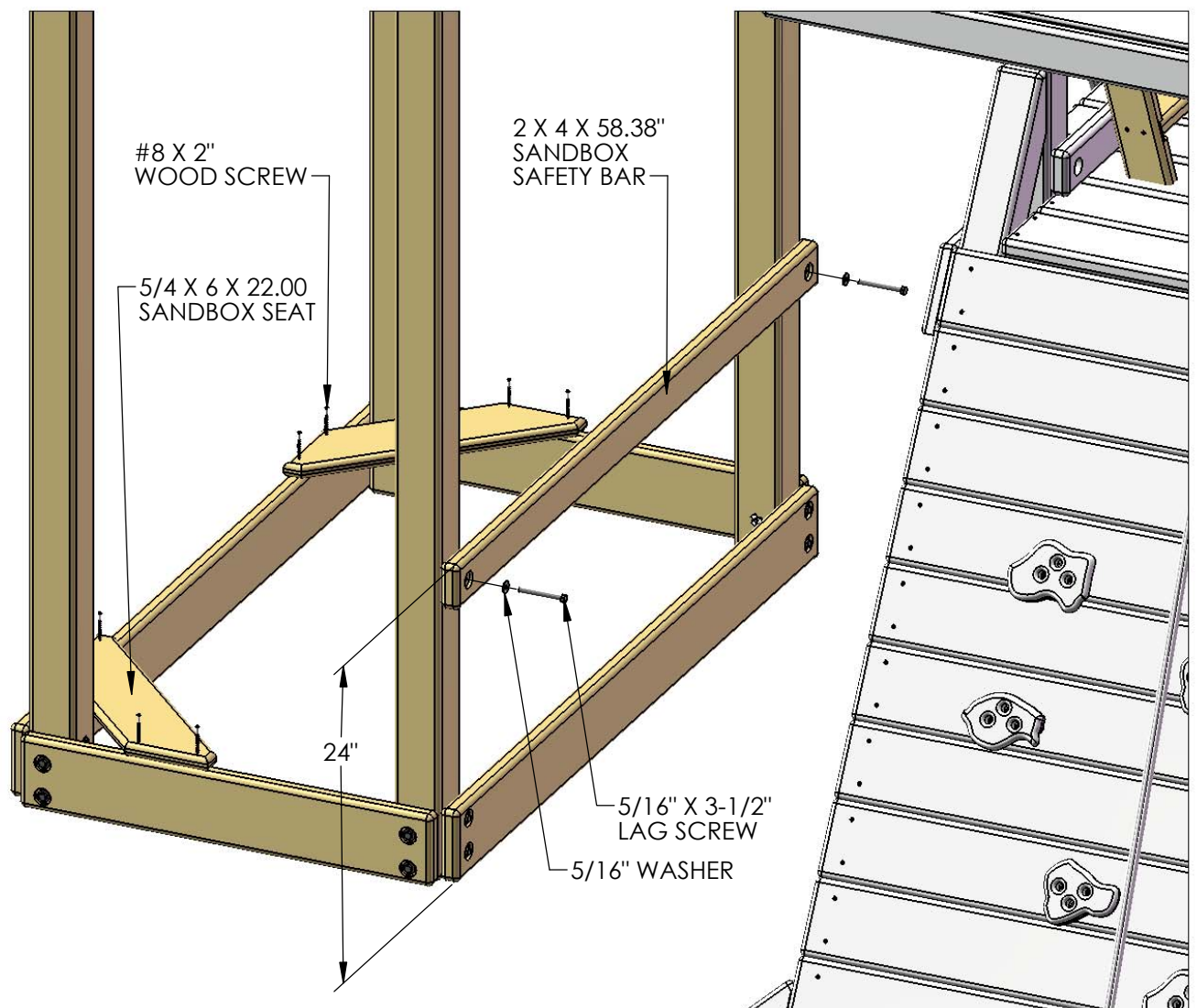

STEP 24: ROOF SUPPORT ASSEMBLIES

1: LOCATE TWO 2 X 4 X 50.77" ROOF SUPPORT LEFT, TWO 2 X 4 X 50.77" ROOF SUPPORT RIGHT AND TWO 5/4 X 5 X 10.00" ROOF PEAK SUPPORT PIECES.

2: FIND A FLAT SURFACE TO WORK ON. LAY THE ROOF SUPPORTS DOWN ON THE FLAT SURFACE WITH THE COUNTERSUNK HOLES FACING UP. ALIGN THE ANGLED ENDS OF THE ROOF SUPPORTS FLUSH WITH ONE ANOTHER, PLACE A ROOF PEAK SUPPORT ON TOP OF THE ROOF SUPPORTS AS SHOWN. THE EDGES SHOULD BE FLUSH WHERE SHOWN.

3: USE FOUR #8 X 2" WOOD SCREWS TO ATTACH THE ROOF PEAK SUPPORT TO THE ROOF SUPPORTS AS SHOWN BELOW.

4: MAKE ONE MORE ROOF SUPPORT ASSEMBLY BY REPEATING SUB STEPS 2 AND 3.

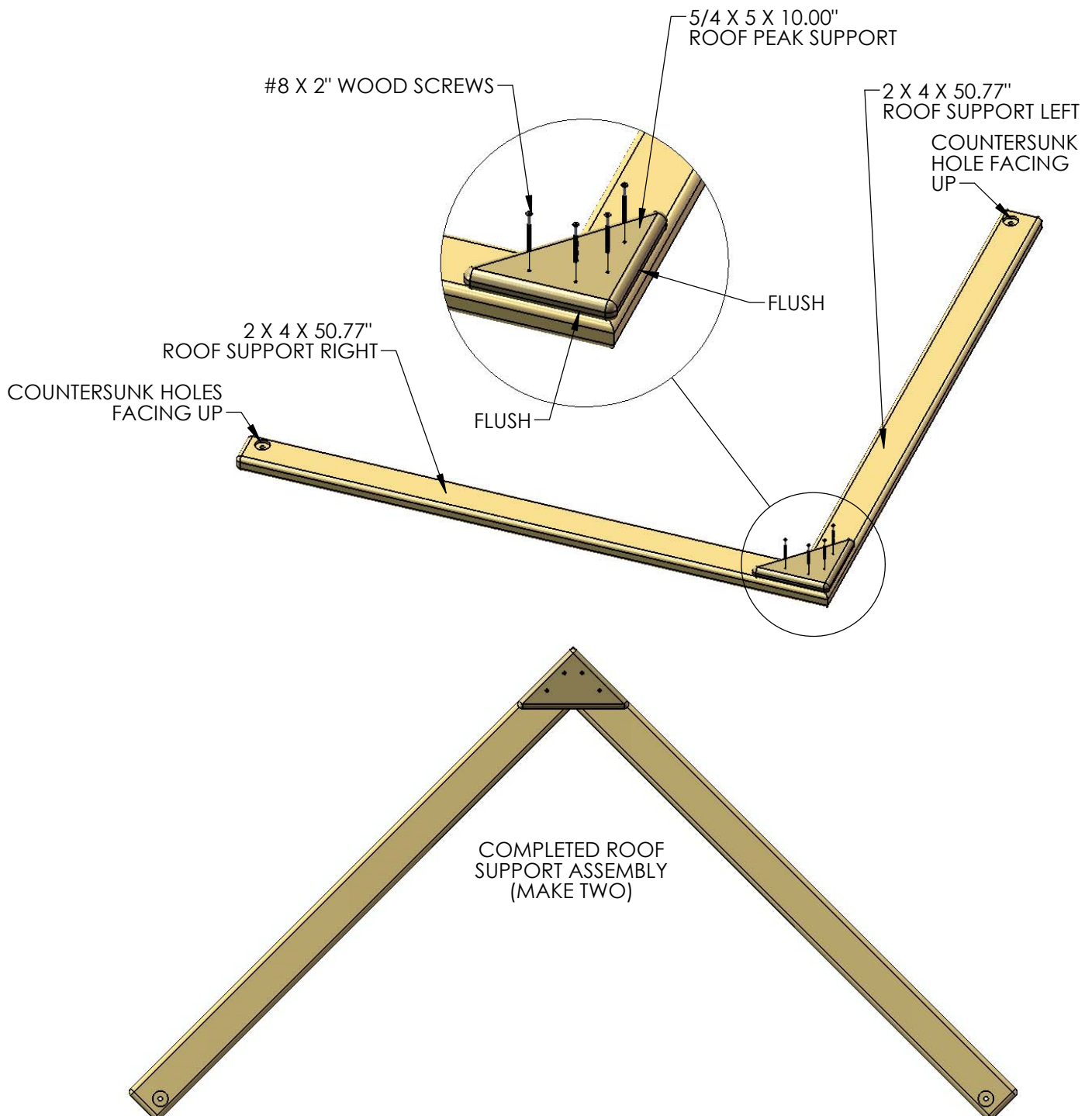

STEP 25: ROOF SUPPORTS

- 1: INSERT T-NUTS INTO THE UPPER HOLES OF THE CORNER POSTS FROM THE INSIDE OF THE FORT AND SET WITH A HAMMER.
- 2: PLACE THE ROOF SUPPORT ASSEMBLY OUTSIDE THE FORT AGAINST THE CORNER POSTS. ATTACH USING 5/16" X 4-1/2" HEX BOLT AND 5/16" WASHERS INTO THE COUNTERSUNK HOLES OF THE ROOF SUPPORTS INTO THE T-NUTS INSTALLED IN THE CORNER POSTS.
- 3: INSERT TWO #8 X 2-1/2" WOODSCREWS THROUGH THE CENTER POST INTO THE ROOF SUPPORT ASSEMBLY AS SHOWN BELOW.
- 4: REPEAT SUB STEPS 2 & 3 FOR THE OTHER SIDE.

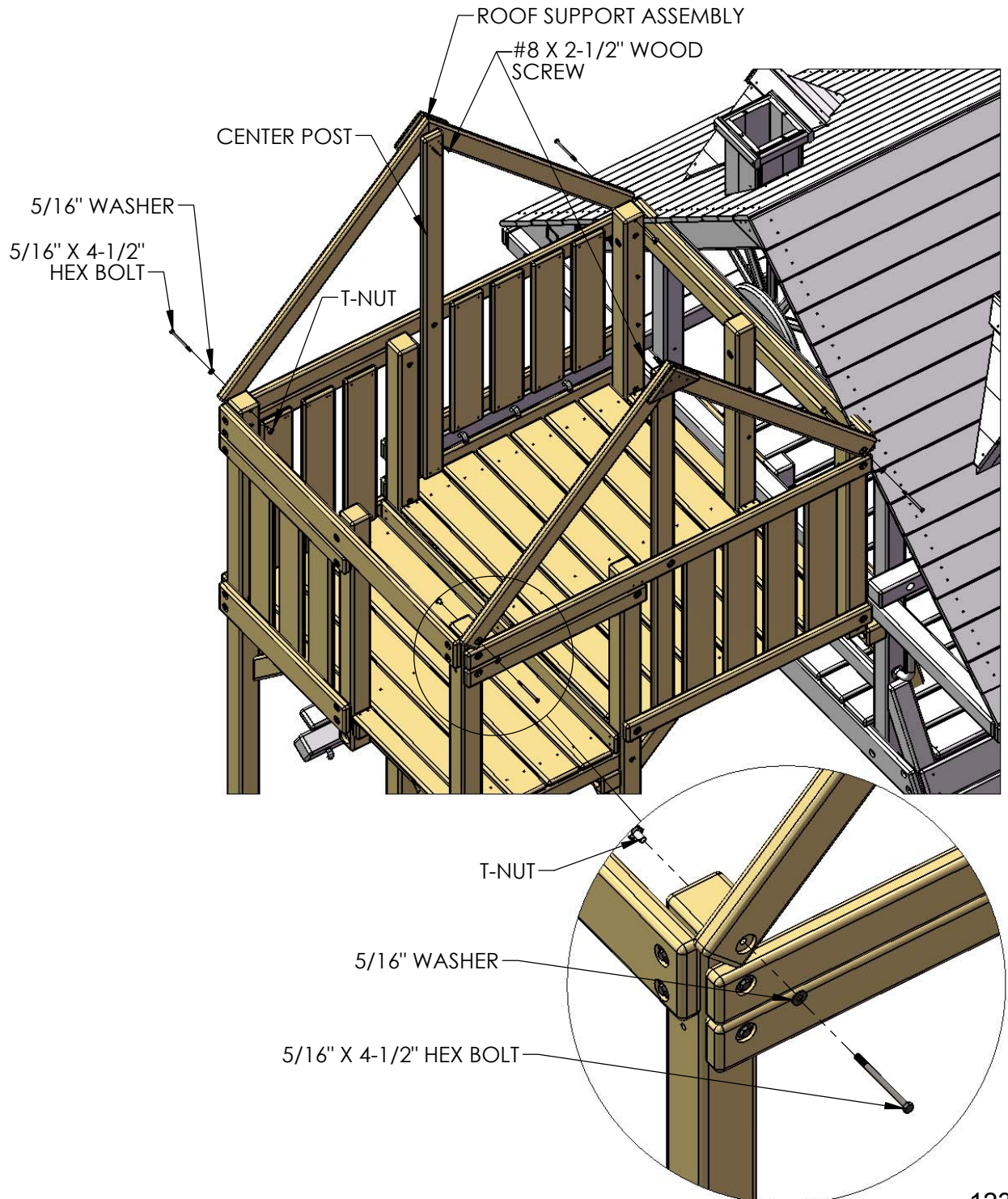

STEP 26: ROOF STARTERS

1: PLACE THE 1 X 4 X 65.38" GROOVE-ONLY ROOF STARTER BOARDS AT THE PEAK OF THE ROOF. THE HOLES IN THE ROOF STARTERS SHOULD BE CENTERED ON THE ROOF SUPPORTS, AND THE FLAT ENDS OF THE ROOF STARTERS SHOULD BE PLACED AS CLOSE TO EACH OTHER AS POSSIBLE WITHOUT THE BOARDS OVERLAPPING.

2: FASTEN THE ROOF STARTER BOARDS TO THE ROOF SUPPORTS WITH #8 X 1-1/2" WOOD SCREWS.

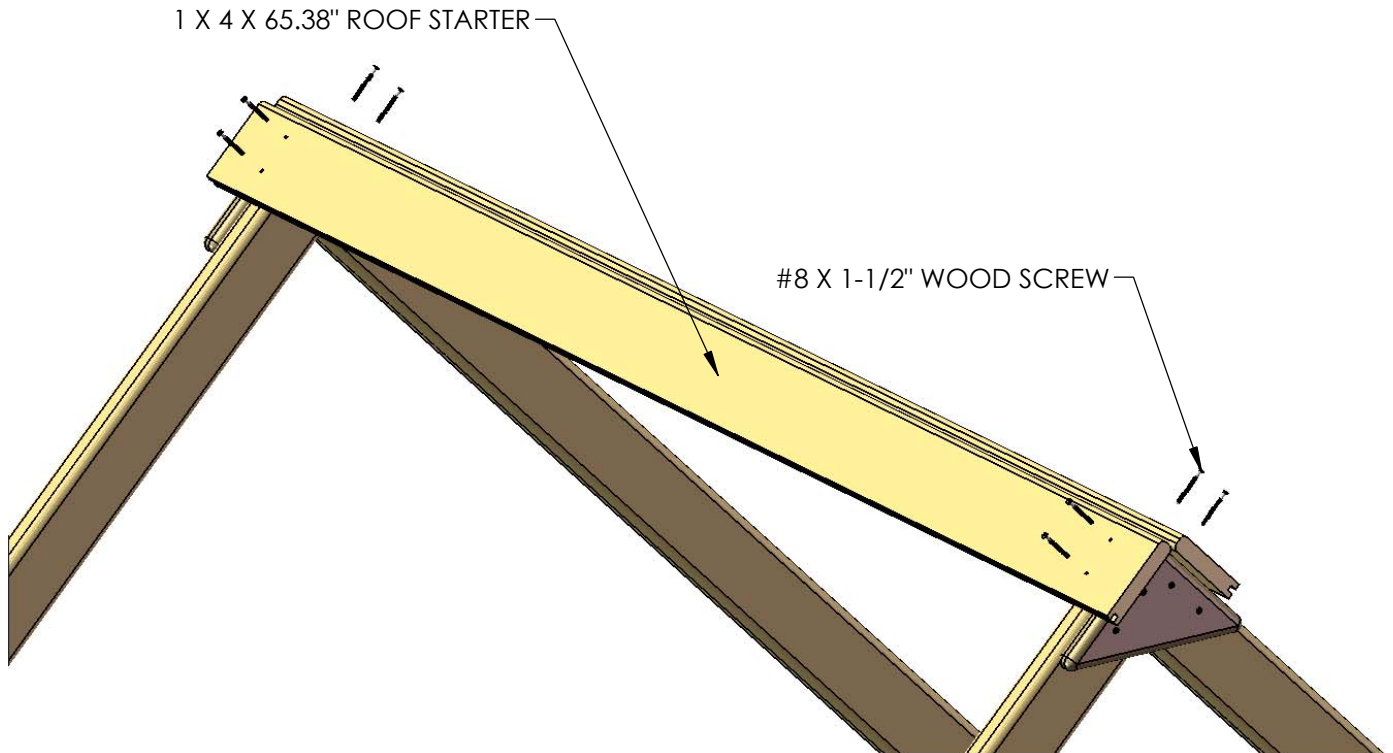

STEP 27: ROOF PEAK

- 1: PLACE THE 1 X 4 X 65.38" ROOF PEAK ON TOP OF THE ROOF STARTER BOARDS.
- 2: FASTEN THE ROOF PEAK TO THE ROOF STARTER BOARDS WITH #8 X 1-1/4" WOOD SCREWS.

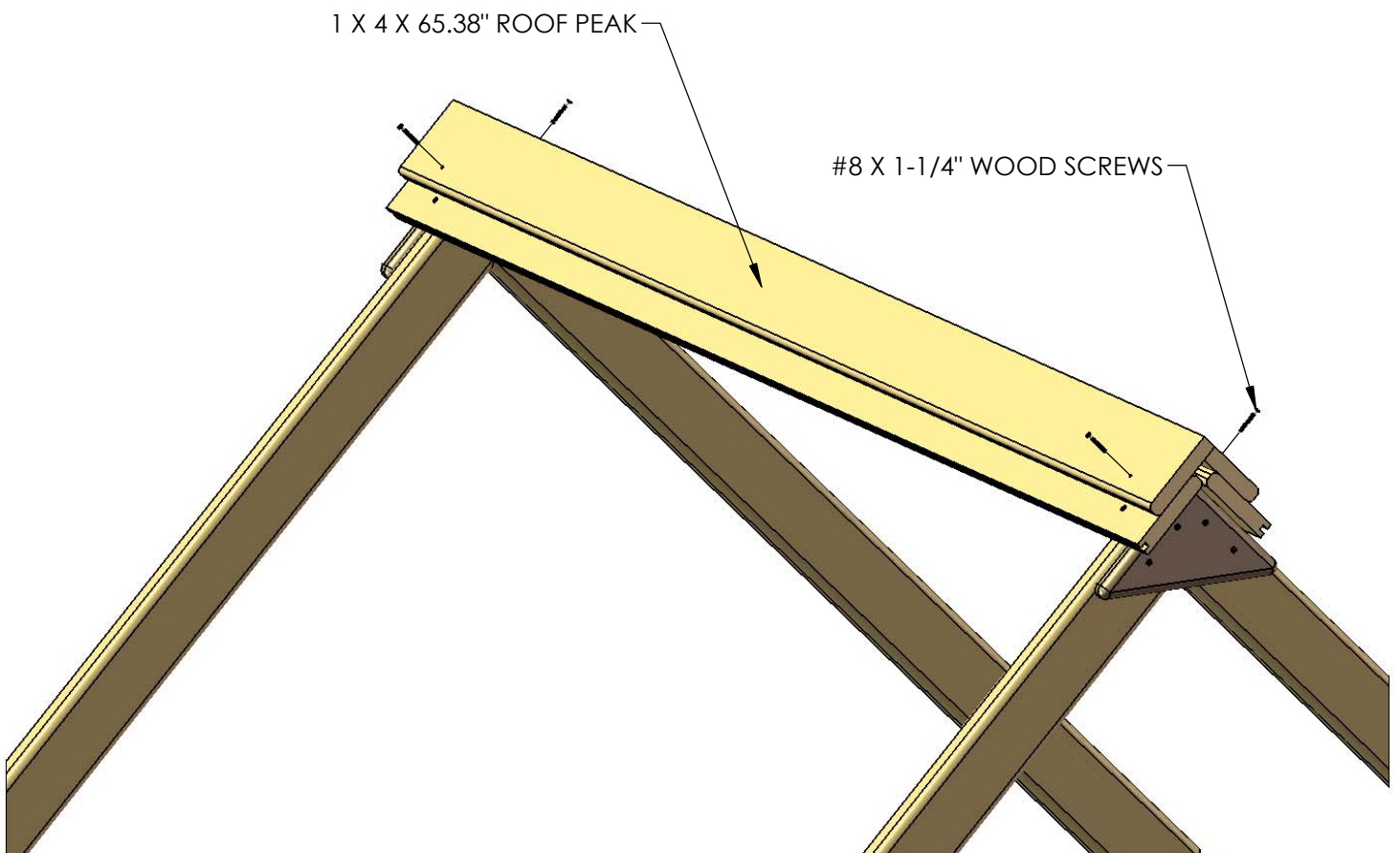

STEP 28: ROOF BOARDS, ROOF FINISHER AND DORMER

1: PLACE THE 1 X 6 X 65.38" ROOF BOARDS ON TOP OF THE RIGHT SIDE ROOF SUPPORTS, FITTING THE TONGUE END INTO THE GROOVE END OF THE ROOF STARTERS. THIS SIDE GETS EIGHT ROOF BOARDS. FASTEN THE ROOF BOARDS TO THE ROOF SUPPORTS WITH #8 X 1-1/2" WOOD SCREWS.

2: PLACE A 1 X 4 X 65.38" ROOF FINISHER ON THE END OF THE ROOF, AND FASTEN USING #8 X 1-1/2" WOOD SCREWS.

3: PLACE THE 1 X 6 X 65.38" ROOF BOARDS ON TOP OF THE LEFT SIDE ROOF SUPPORTS, FITTING THE TONGUE END INTO THE GROOVE END OF THE ROOF STARTERS. THIS SIDE GETS NINE ROOF BOARDS. FASTEN THE ROOF BOARDS TO THE ROOF SUPPORTS WITH #8 X 1-1/2" WOOD SCREWS.

3: PLACE A 1 X 4 X 65.38" ROOF FINISHER ON THE END OF THE ROOF, AND FASTEN USING #8 X 1-1/2" WOOD SCREWS.

4: USE THE INSTRUCTIONS PROVIDED WITH THE DORMER TO BUILD IT. AFTER INSTALLING THE SEVENTH ROOF BOARD INSTALL THE DORMER ACCORDING TO THE DORMER INSTRUCTIONS. THEN FINISH INSTALLING THE REMAINING ROOF BOARDS AND ROOF FINISHER.

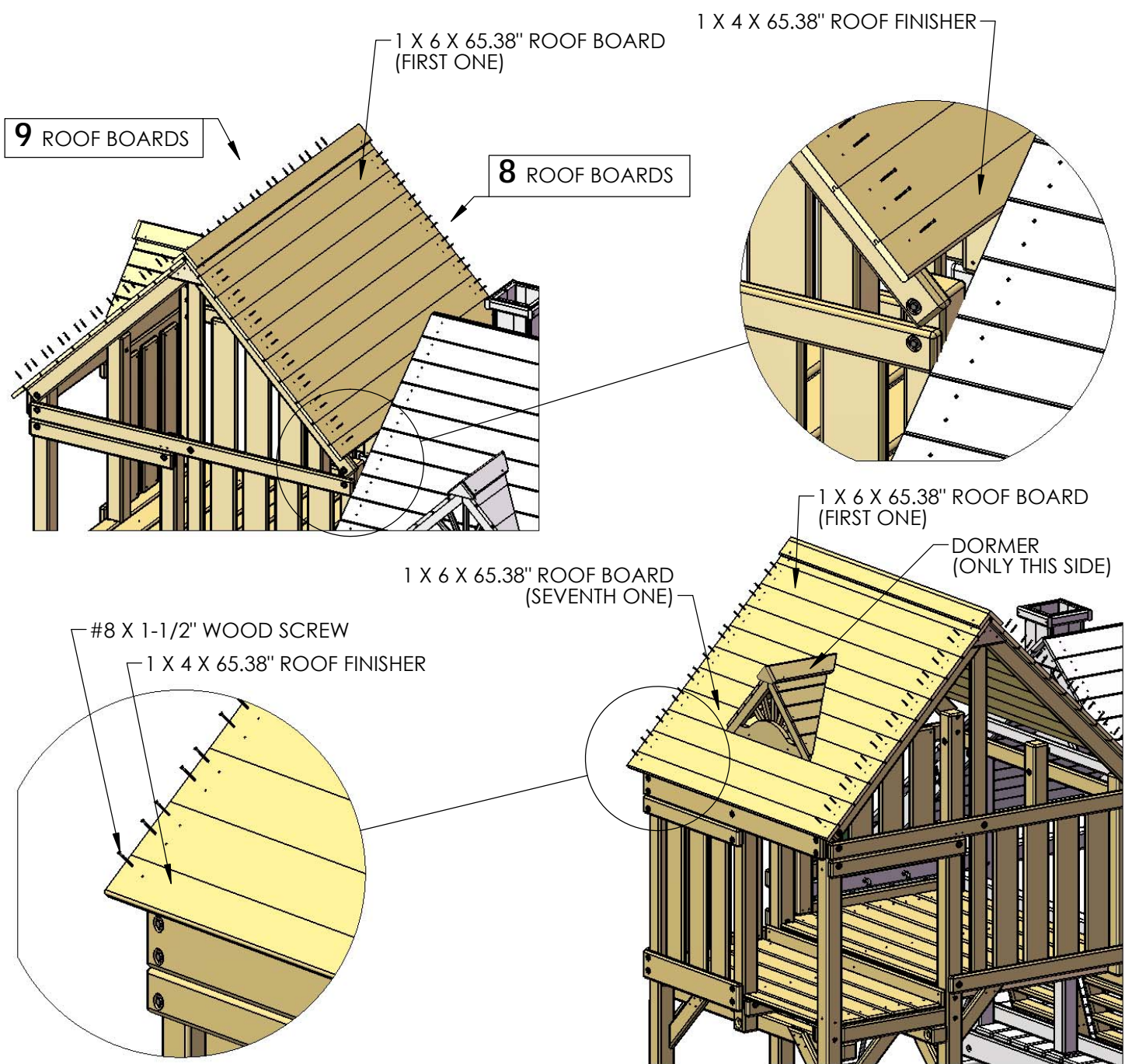

STEP 29: SUNBURST

1: PLACE THE 2 X 6 X 13.63" SUN CENTERED ON TOP OF THE 2 X 4 X 31.19" SUN SUPPORT. FASTEN THE SUN TO THE SUN SUPPORT WITH #8 X 3" WOOD SCREWS. REPEAT THIS PROCESS FOR THE OTHER SIDE OF THE FORT.

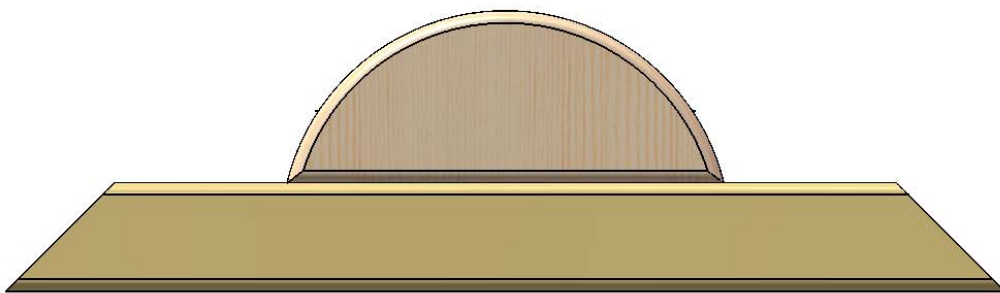
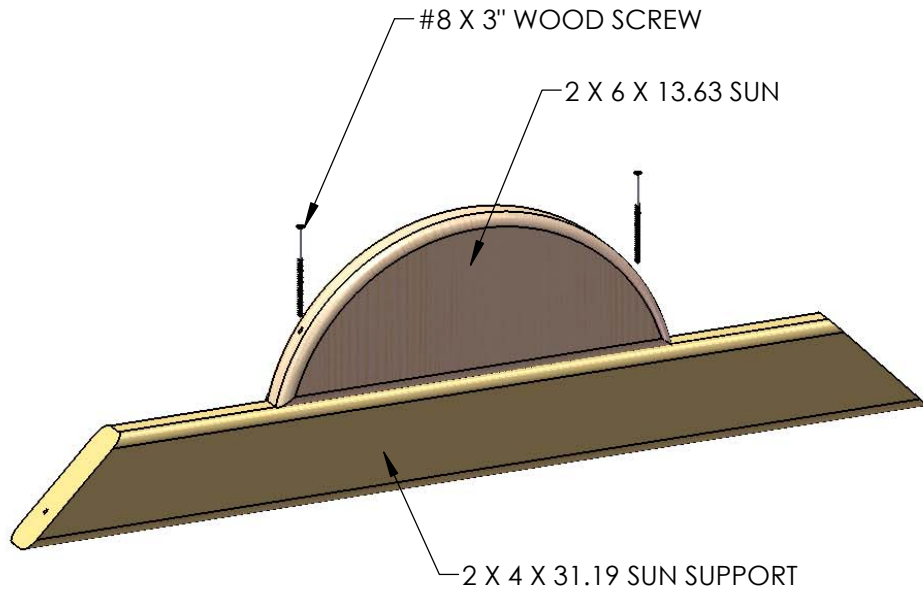

STEP 30: SUNBURST

1: PLACE THE ASSEMBLY MADE IN THE PREVIOUS STEP CENTERED UNDERNEATH THE ROOF SUPPORTS. MAKE SURE THE ASSEMBLY IS LEVEL BEFORE PROCEEDING TO THE NEXT STEP.

2: FASTEN THE SUN ASSEMBLY TO THE FORT WITH #8 X 2-1/2" WOOD SCREWS FROM THE BOTTOM INTO THE ROOF SUPPORTS.

3: REPEAT ON THE OTHER SIDE OF THE FORT.

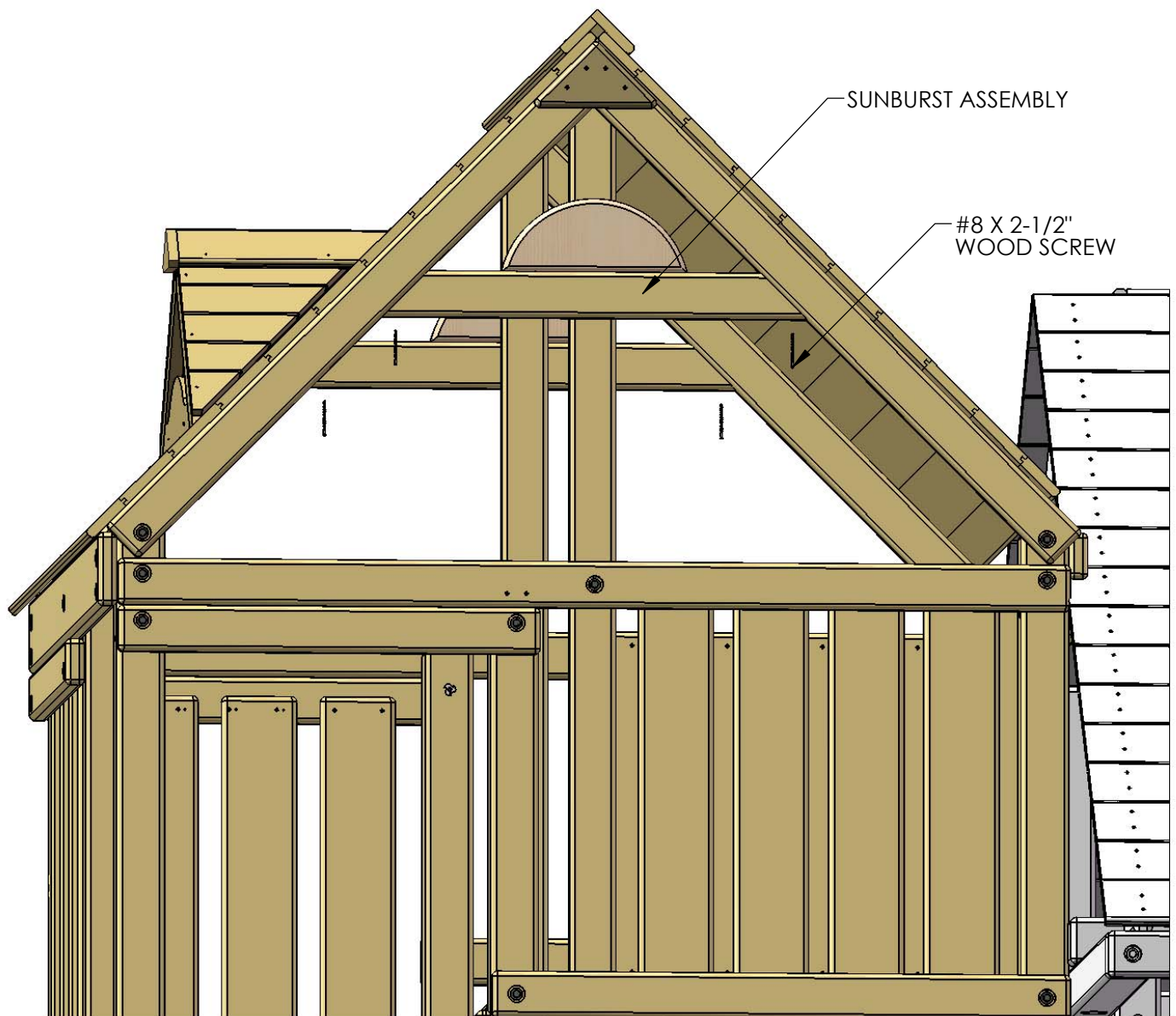

STEP 31: SUNRAYS

1: EQUALLY SPACE THE 5/4 X 2 X 8.00" SUNRAYS ABOUT THE HALF SUN (THREE ON EACH SIDE OF THE CENTER POST) AND MARK THE POSITION OF THE SMALL SUNRAYS WITH A PENCIL.

2: SECURE THE SUNRAYS ONE AT A TIME TO THE HALF SUN AND THE ROOF SUPPORT BEAMS AND LINE THEM UP WITH THE MARK DRAWN. FASTEN THE SUNRAYS WITH TWO #8 X 2" WOOD SCREWS EACH. REPEAT ON OTHER SIDE OF FORT.

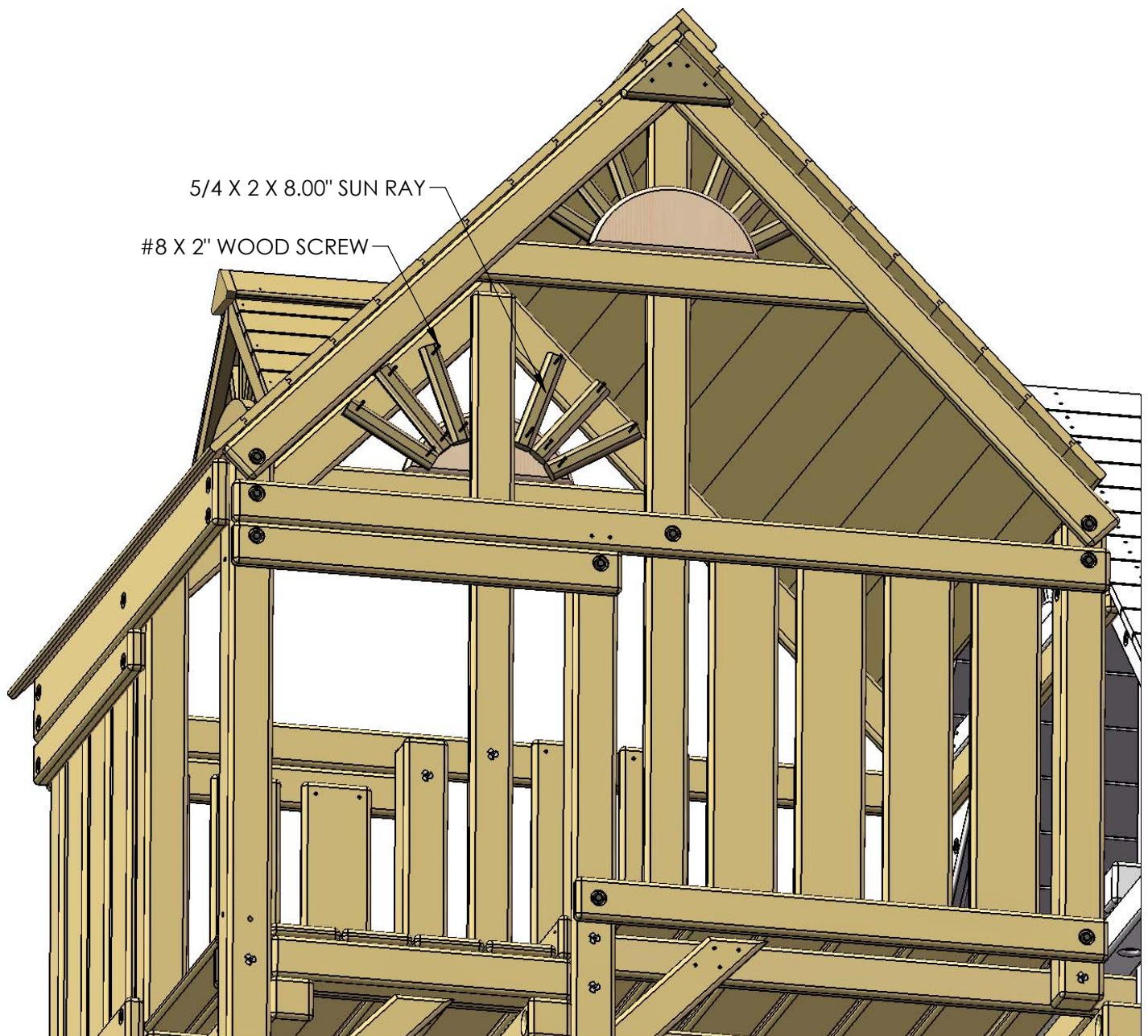

STEP 32: WALL PANEL BOARDS

1: FIND TWO 1 X 3 X 11.25" WINDOW TOP/BOTTOM BOARDS AND PLACE THEM AGAINST THE TOP PANEL BOARD AND SUN SUPPORT, FOLLOW THE DIMENSIONS OF THE DIAGRAM BELOW AND ATTACH USING #8 X 1-1/2" WOOD SCREWS. NOTE: THE **PREDRILLED HOLES** MUST BE **OFFSET UP** FOR THE TOP BOARDS AND **OFFSET DOWN** FOR THE BOTTOM BOARDS.

2: FIND TWO 1 X 4 X 24.75" WALL PANEL BOARDS, PLACE THEM AGAINST THE ROOF SUPPORT AND TOP PANEL BOARD, THE ANGLED END MUST BE POINTING UP FOLLOWING THE PITCH OF THE ROOF BOARDS. FASTEN USING FOUR #8 X 1-1/2" WOOD SCREWS PER BOARD.

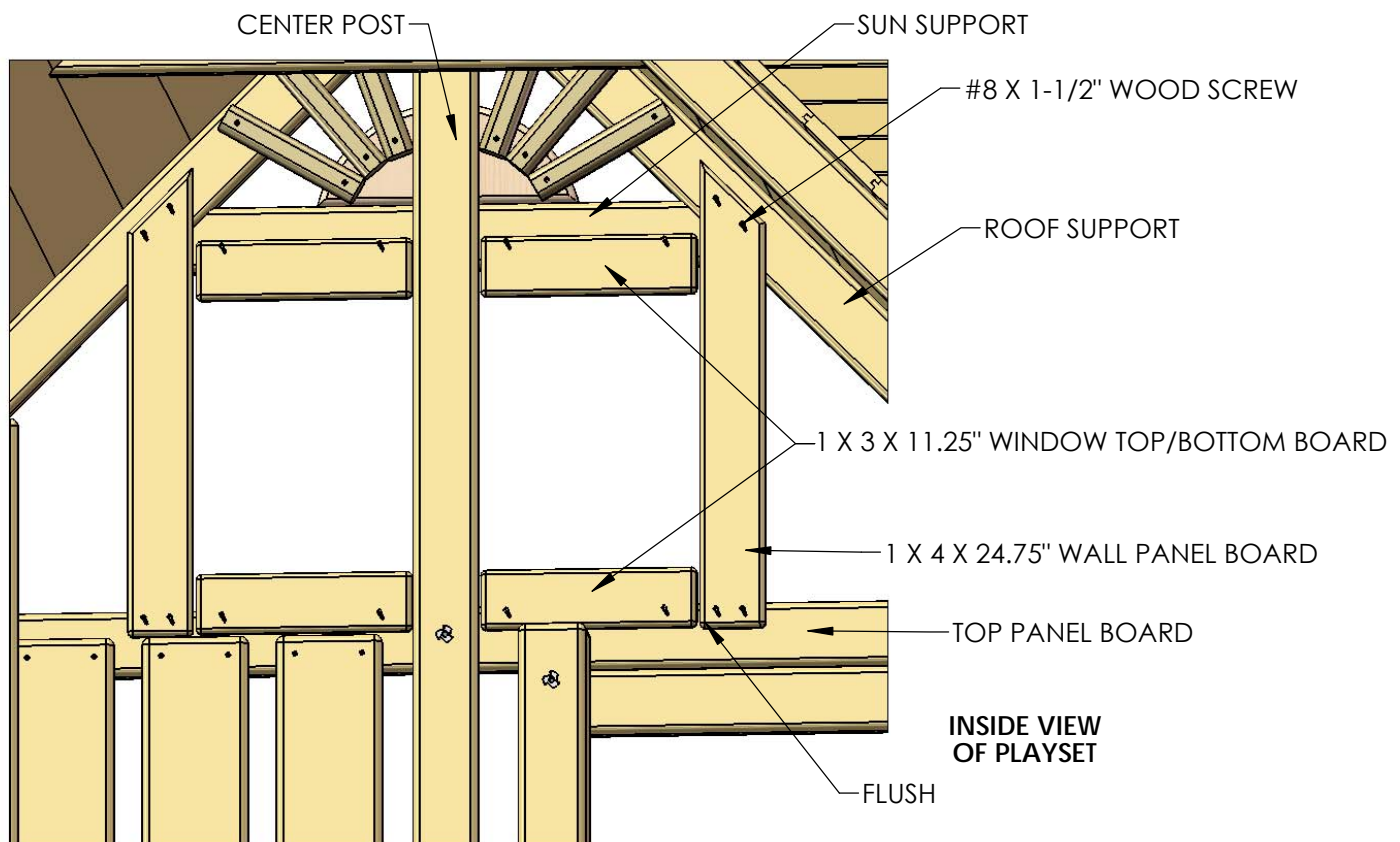
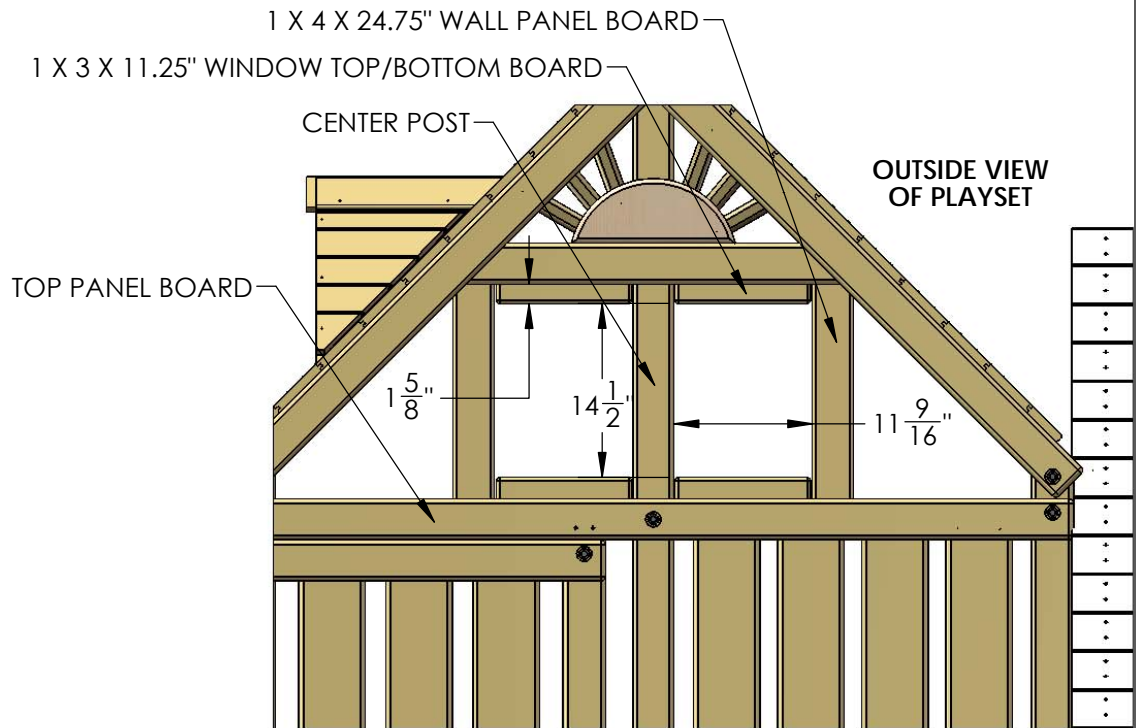

STEP 33: PLASTIC WINDOWS AND PLASTIC CROWN

1: FIND TWO PLASTIC WINDOWS, PLACE EACH WINDOW IN THE OPENING BETWEEN THE WALL PANEL BOARDS AND THE CENTER POST. MAKE SURE THE 1" WIDE SECTION OF THE WINDOW FRAME IS POSITIONED AT THE TOP. ATTACH EACH WINDOW WITH FOUR #8 X 1-1/4" WOOD SCREWS.

NOTE: IF THE PLASTIC WINDOWS FIT TOO TIGHT OR TOO LOOSE IN BETWEEN THE BOARDS, YOU CAN UNSCREW AND ADJUST THE WALL PANEL BOARDS .

2: PLACE THE PLASTIC CROWN ON TOP OF THE SUN ABOVE THE SUN SUPPORT. ATTACH USING TWO #8 X 1-1/4" WOOD SCREWS.

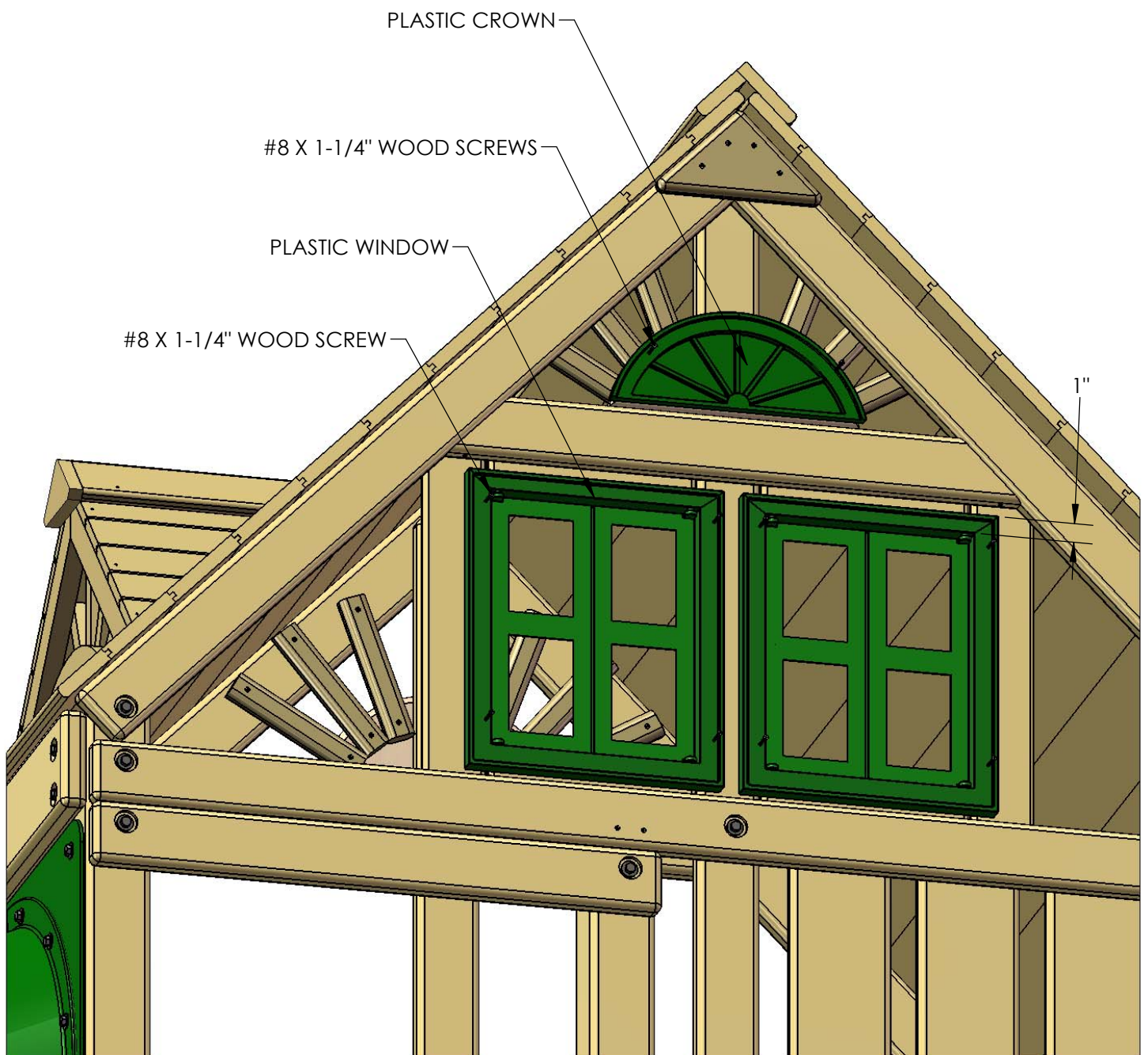

STEP 34: WALL PANEL BOARDS

1: FIND ONE 1 X 4 X 21.38" WALL PANEL BOARD AND PLACE IT NEXT TO THE PREVIOUSLY INSTALLED WALL PANEL BOARD LEAVING APPROXIMATELY A 1/4" GAP IN BETWEEN. MAKE SURE THE ANGLED END IS POINTING UP FOLLOWING THE ROOF SUPPORT PITCH. THE BOTTOM END MUST BE FLUSH TO THE PREVIOUS ONE. ATTACH USING FOUR #8 X 1-1/2" WOOD SCREWS.

2: FIND ONE 1 X 4 X 17.75" WALL PANEL BOARD AND PLACE IT NEXT TO THE PREVIOUSLY INSTALLED WALL PANEL BOARD LEAVING APPROXIMATELY A 1/4" GAP IN BETWEEN. MAKE SURE THE ANGLED END IS POINTING UP FOLLOWING THE ROOF SUPPORT PITCH. THE BOTTOM END MUST BE FLUSH TO THE PREVIOUS ONE. ATTACH USING FOUR #8 X 1-1/2" WOOD SCREWS.

3: FIND ONE 1 X 4 X 14.25" WALL PANEL BOARD AND PLACE IT NEXT TO THE PREVIOUSLY INSTALLED WALL PANEL BOARD LEAVING APPROXIMATELY A 1/4" GAP IN BETWEEN. MAKE SURE THE ANGLED END IS POINTING UP FOLLOWING THE ROOF SUPPORT PITCH. THE BOTTOM END MUST BE FLUSH TO THE PREVIOUS ONE. ATTACH USING FOUR #8 X 1-1/2" WOOD SCREWS.

4: FIND ONE 1 X 4 X 10.50" WALL PANEL BOARD AND PLACE IT NEXT TO THE PREVIOUSLY INSTALLED WALL PANEL BOARD LEAVING APPROXIMATELY A 1/4" GAP IN BETWEEN. MAKE SURE THE ANGLED END IS POINTING UP FOLLOWING THE ROOF SUPPORT PITCH. THE BOTTOM END MUST BE FLUSH TO THE PREVIOUS ONE. ATTACH USING FOUR #8 X 1-1/2" WOOD SCREWS.

5: REPEAT SUB STEP 1 TO 4 FOR THE OTHER SIDE.

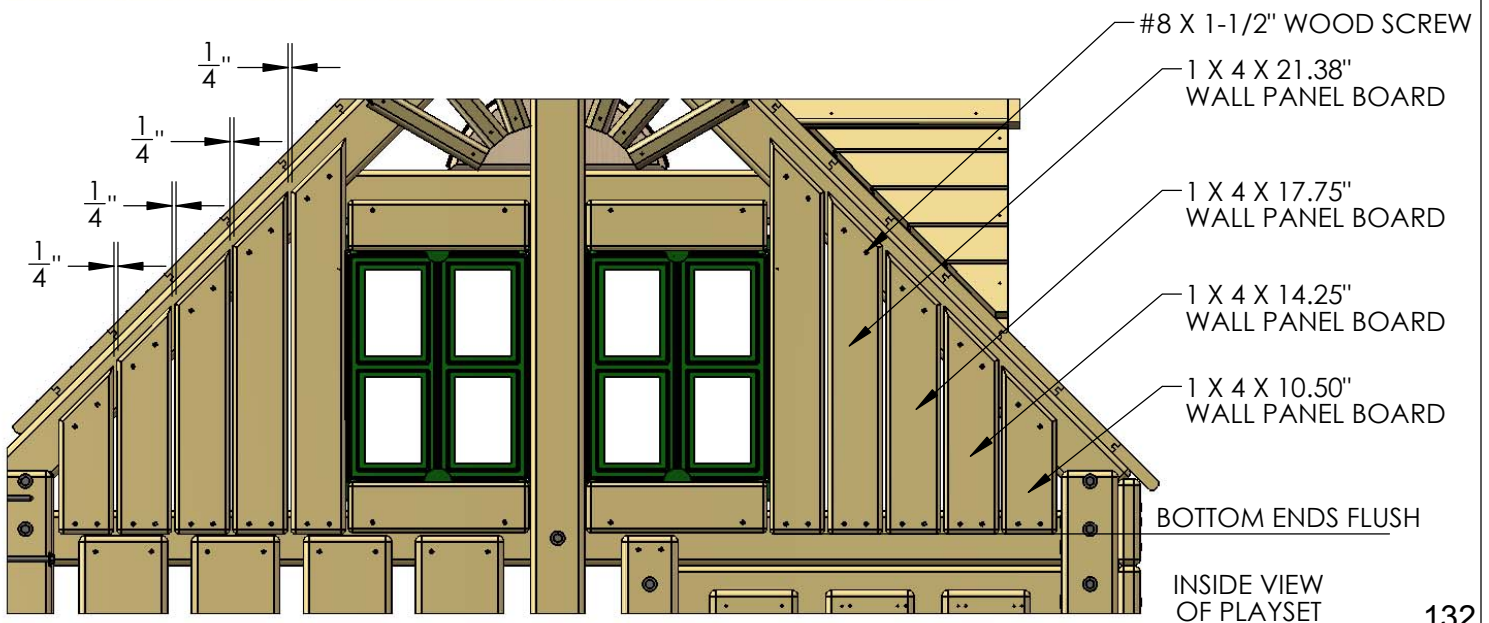
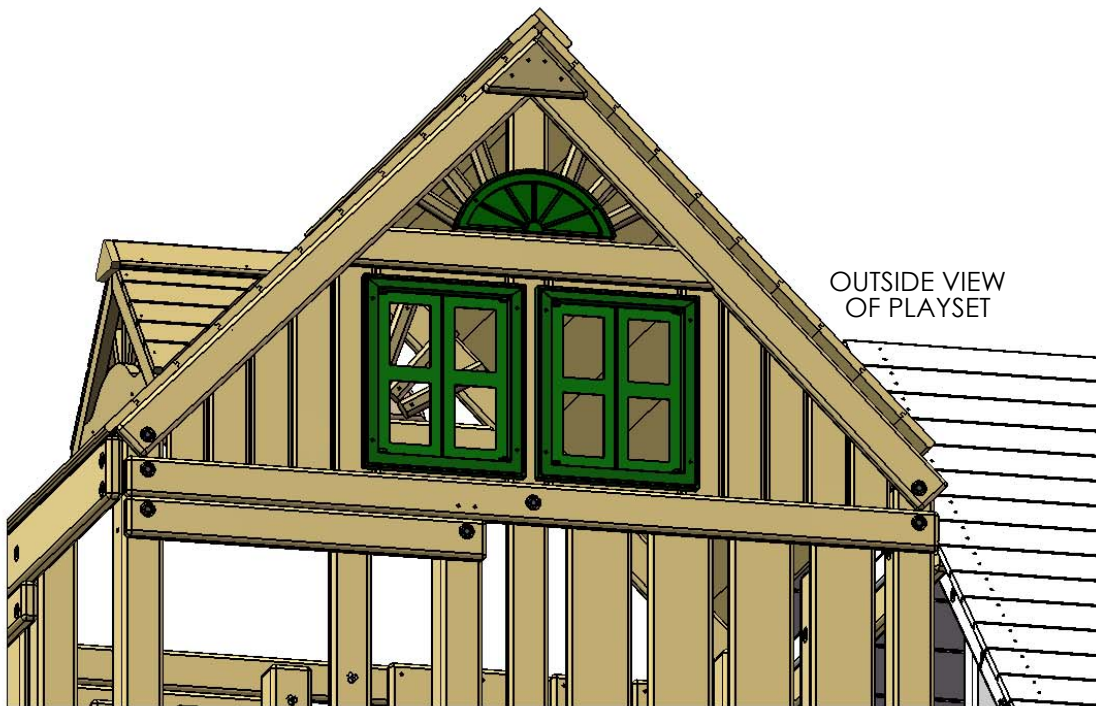

STEP 35: ATTACHING THE RAD RIDE TO THE FORT

- 1: REMOVE LAGS AND WASHERS FROM THE WALL PANEL (CENTER POST ONLY).
- 2: ASSEMBLE THE RAD RIDE ACCORDING TO THE INSTRUCTIONS PROVIDED. SEE BELOW FOR PLACEMENT OF YOUR SLIDE.
- 3: ATTACH THE ENTRY OF THE SLIDE TO THE FORT CORNER END CENTER POST. REPLACE THE REMOVED LAGS AND WASHER, INSERT $5/16"$ X $3-1/2"$ LAGS AND $5/16"$ WASHER INTO THE REMAINING HOLES.

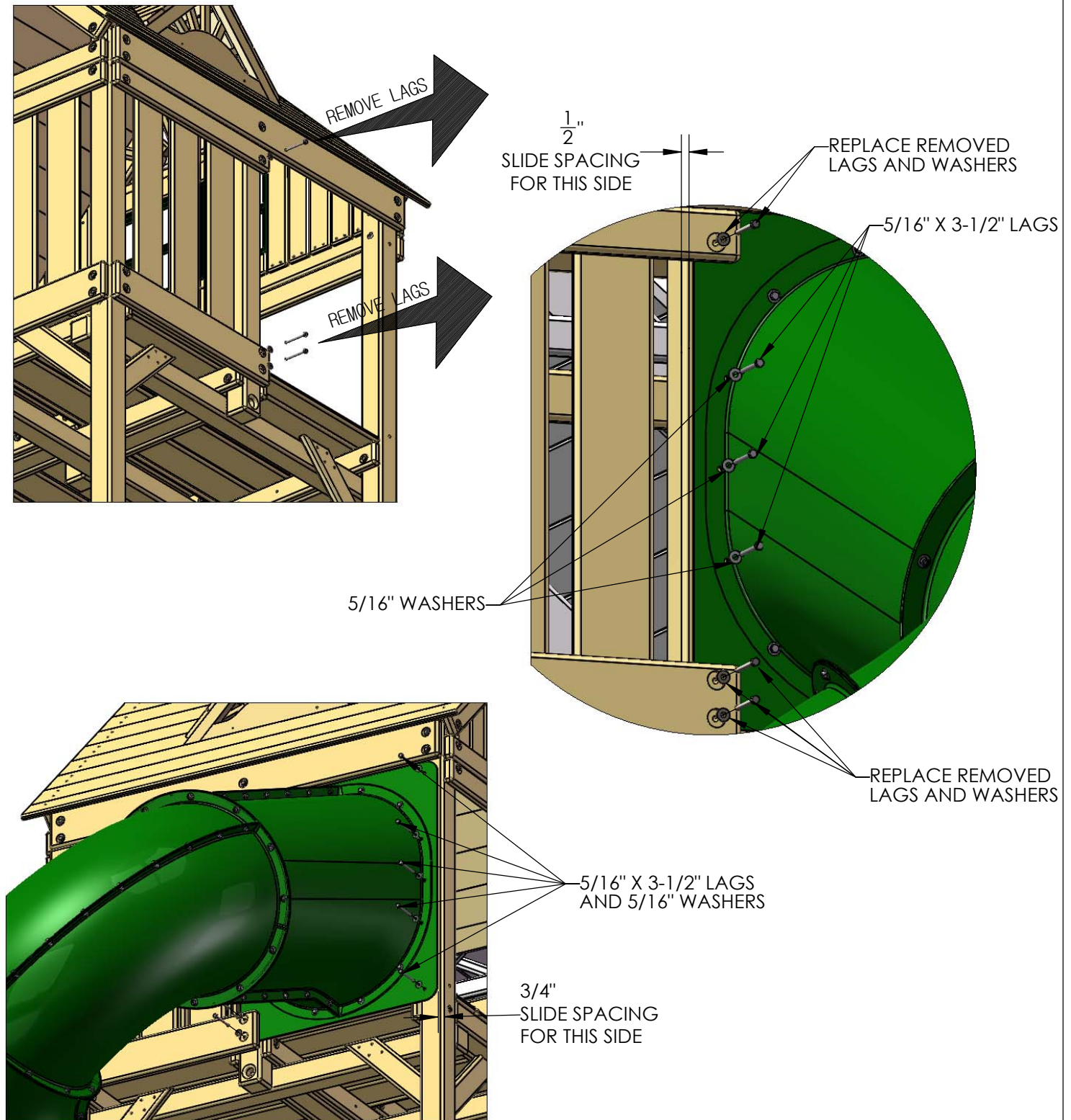

STEP 36: ATTACHING THE SUPER SCOOP SLIDE

1: PLACE THE SUPER SCOOP SLIDE IN THE OPENING OF THE FORT. LAY THE SLIDE ON THE DECK WITH THE LIP EXTENDING ONTO THE DECK.

2: ATTACH THE SLIDE TO THE DECK WITH #14 X 3" PAN HEAD SCREWS.

*****DO NOT OVER TIGHTEN*****

#14 X 3" PAN HEAD SCREW

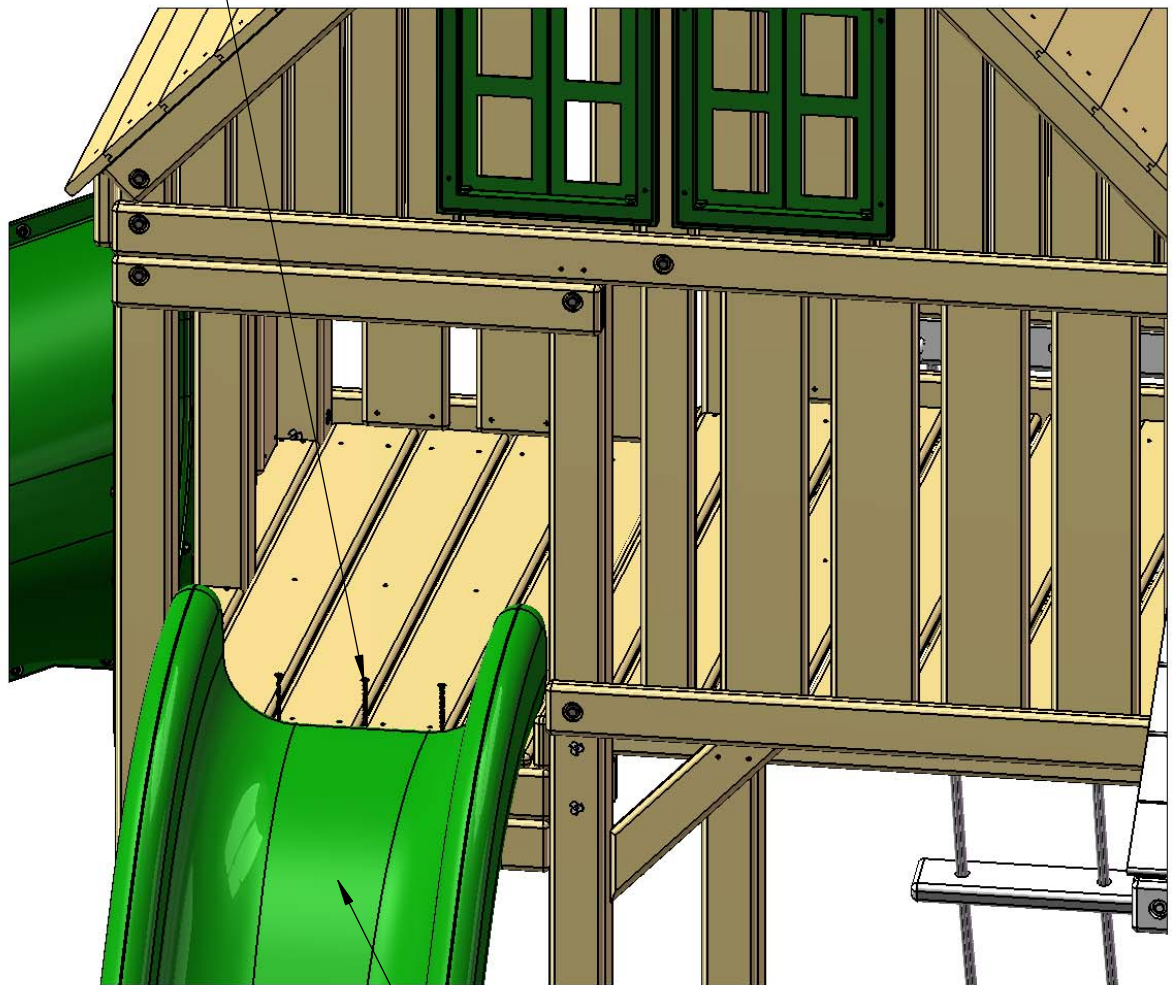

SUPER SCOOP SLIDE

STEP 37: PUNCHING BAG

1: THE PUNCHING BAG COMES WITH A SHORT SECTION OF CHAIN ATTACHED TO IT WITH AN "S"-HOOK.

2: ATTACH THE END OF THE CHAIN TO THE IRON DUCTILE WITH A SPRING CLIP.

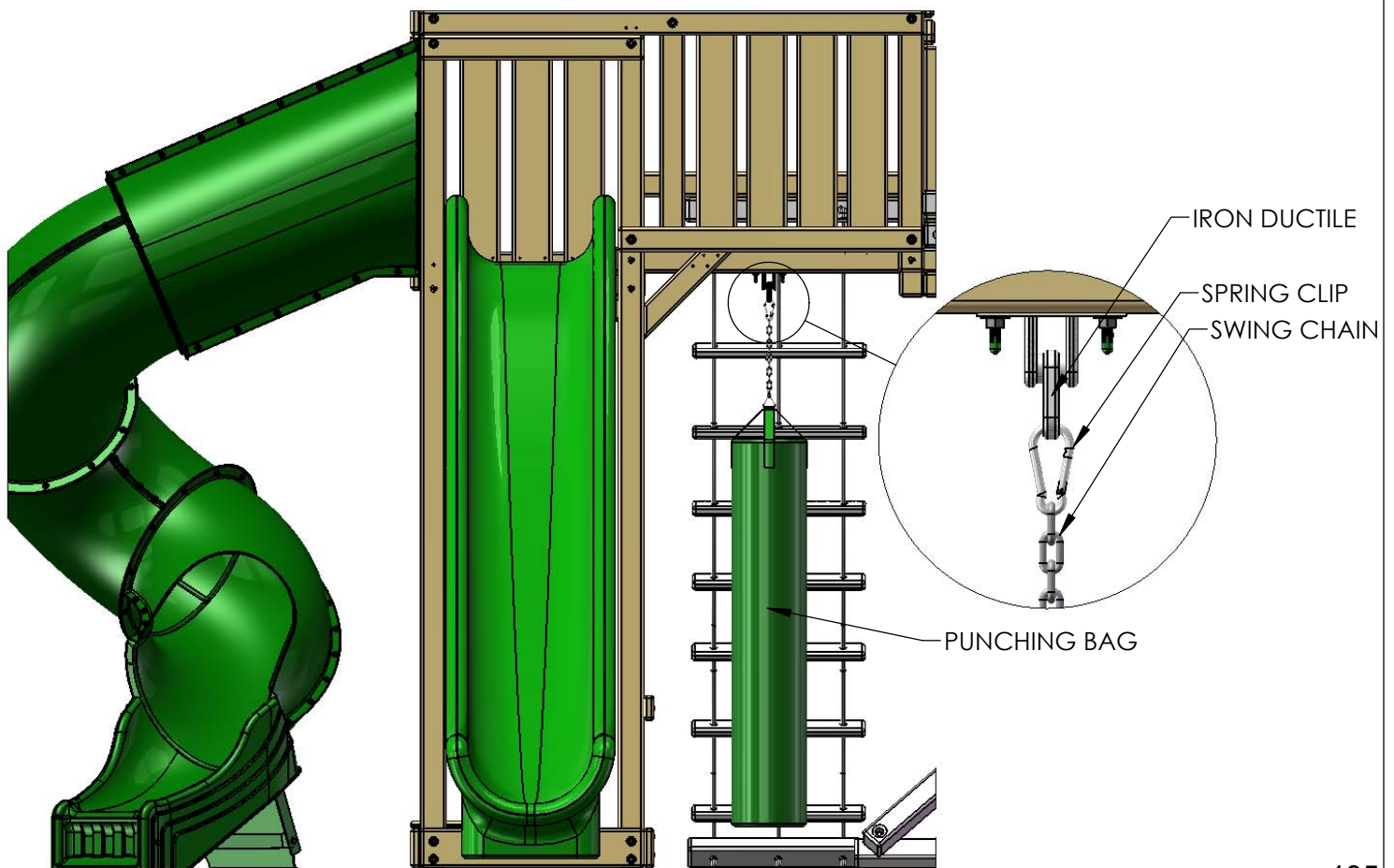

STEP 38: MOUNTING THE TELESCOPE

1: WITH THE 1-1/4" WOOD SCREWS PROVIDED IN THE TELESCOPE BAG, FASTEN ONE OF THE SQUARE TELESCOPE BRACKETS TO THE FRONT TOP PANEL BOARD ON THE REAR SIDE TOP PANEL BOARD.

2: PLACE THE TELESCOPE STAND AND THE TELESCOPE INTO THE SLOT OF THE TELESCOPE BRACKET.

3: FASTEN THE REMAINING TELESCOPE BRACKET TO THE OPPOSITE SIDE THAT THE FIRST TELESCOPE BRACKET WAS INSTALLED ON WITH 1-1/4" WOOD SCREWS PROVIDED WITH THE TELESCOPE.

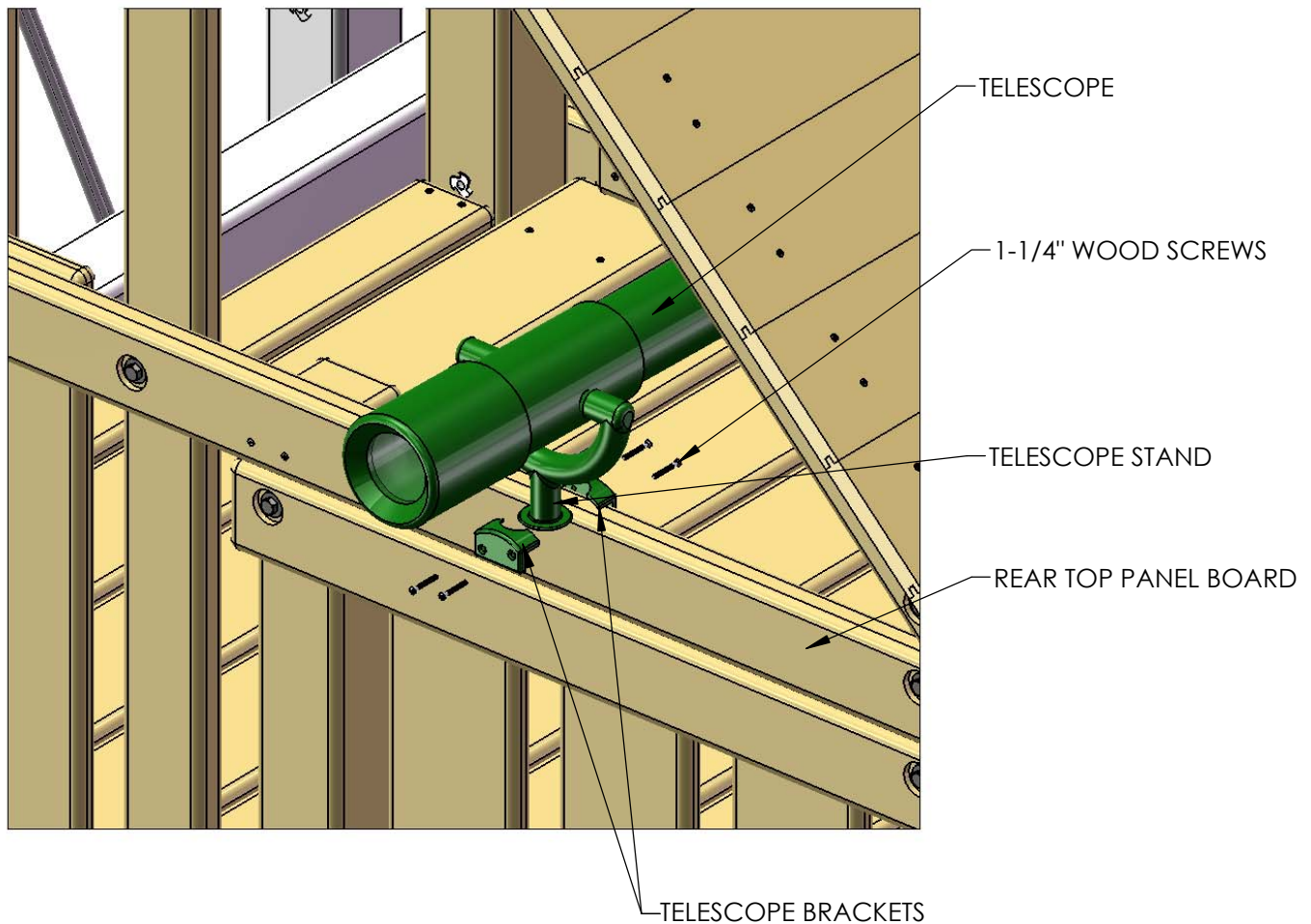

STEP 39: SAFETY HANDLES (UPPER LEVEL)

1: LOCATE THE SAFETY HANDLE BAG.

2: ADJUST THE SAFETY HANDLE UP OR DOWN TO SUIT THE NEEDS OF YOUR CHILD.

3: ATTACH EACH SAFETY HANDLE TO THE UPPER LEVEL CORNER POSTS AND CENTER POST WITH TWO PAN HEAD SCREWS AND TWO WASHERS PROVIDED WITH THE SAFETY HANDLES.

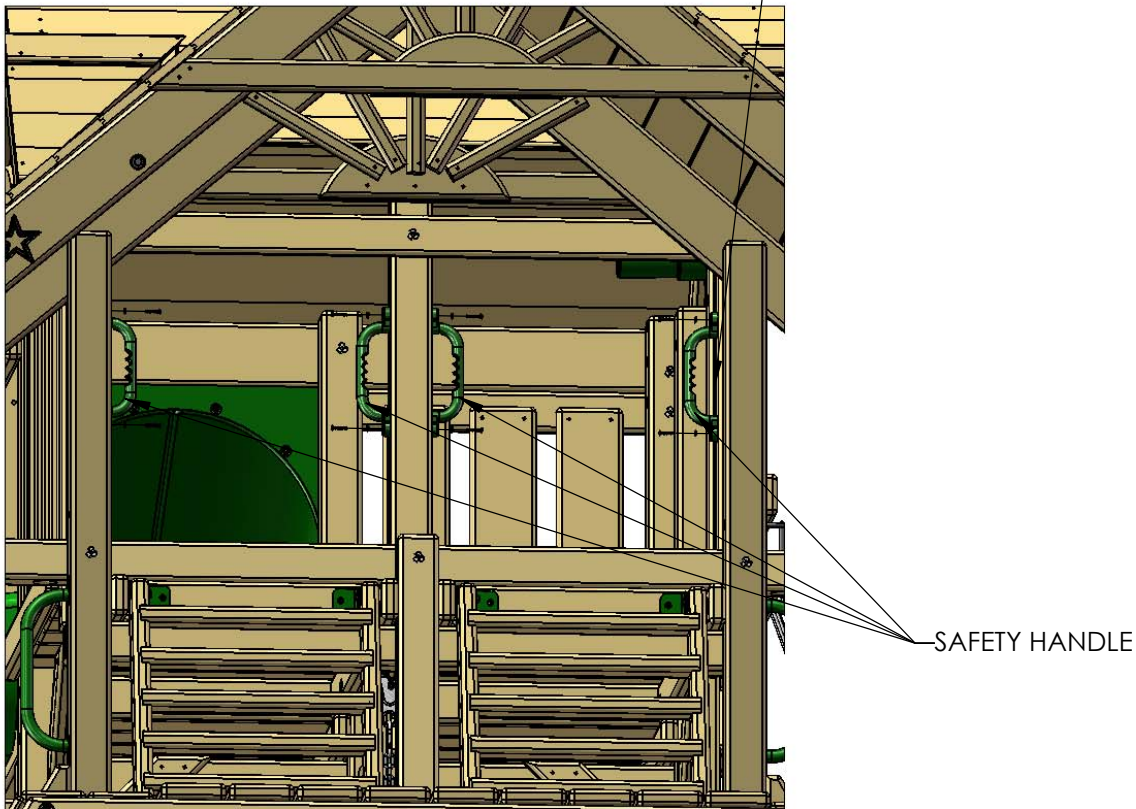
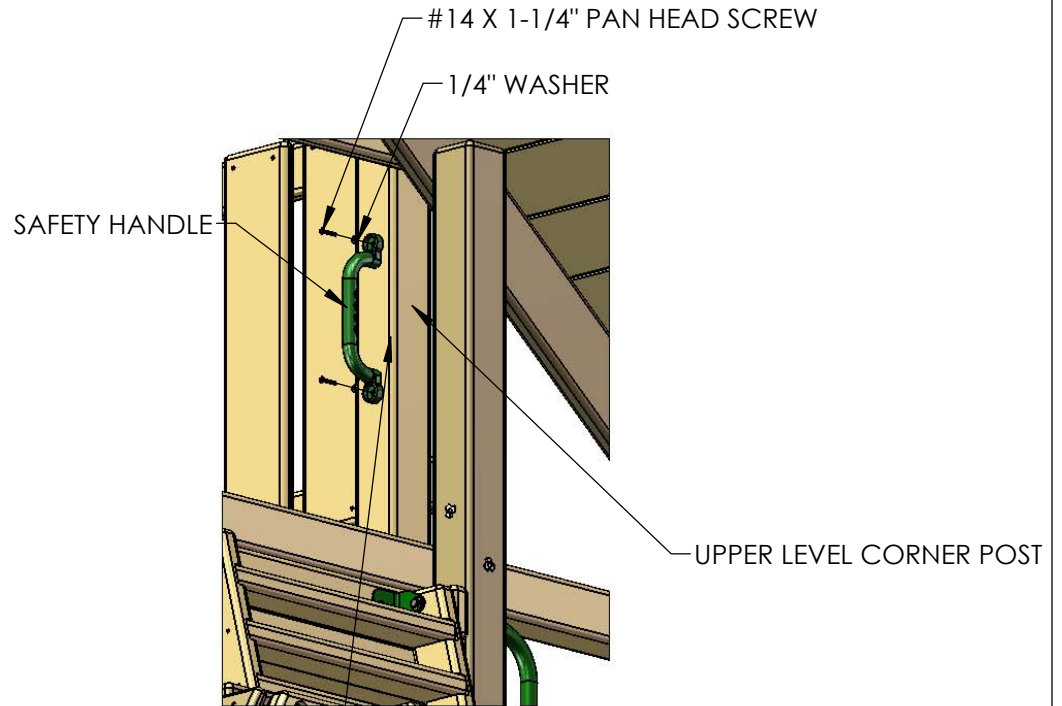

STEP 40: FLAG KITS

1: INSTALL THE FLAG KITS IN THE DESIRED LOCATION ON YOUR PLAY SET. THE RECOMENDED LOCATION IS ON THE SIDE RAIL BETWEEN THE LOWER AND UPPER LEVEL. ATTACH THE FLAG KITS WITH THE HARDWARE PROVIDED.

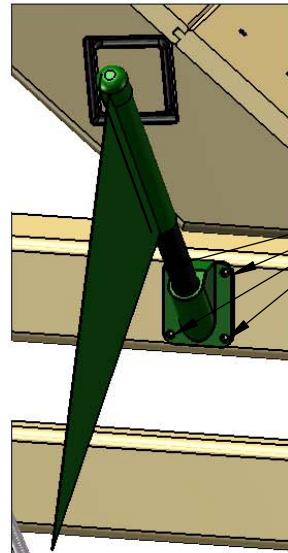

ATTACH WITH PHILLIPS
PAN HEAD SCREWS
PROVIDED WITH THE
FLAGS.

DETAIL A
SCALE 1 : 6



APPENDIX

#8 X 1-1/4"
WOOD SCREW
QTY: 22



#8 X 1-1/2"
WOOD SCREW
QTY: 8



#8 X 2"
WOOD SCREW
QTY: 6



9

8

7

6

5

4

3

2

1

USE THE RULER TO THE RIGHT TO MEASURE YOUR BOLTS AND SCREWS. PICTURE VIEWS SHOWN ABOVE ARE 1:1 SCALE AND CAN BE USED TO MATCH BOLT AND SCREW SIZES.

PICTURE

DESCRIPTION

QTY.

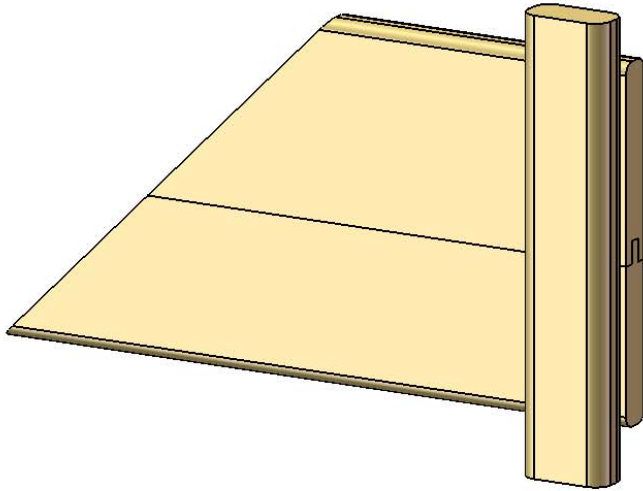

CHIMNEY
LEFT SIDE
ASSEMBLY

1

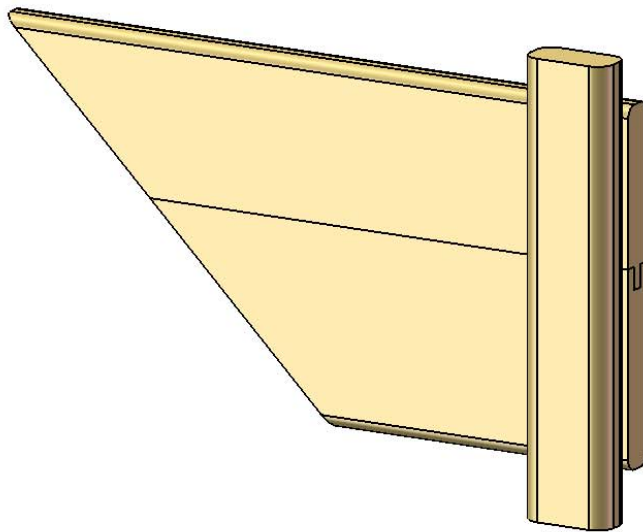

CHIMNEY
RIGHT SIDE
ASSEMBLY

1

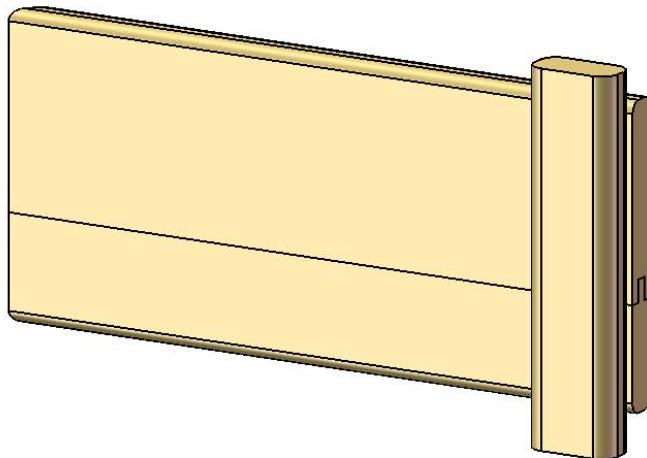

CHIMNEY
FRONT
ASSEMBLY

1

PICTURE

DESCRIPTION

QTY.

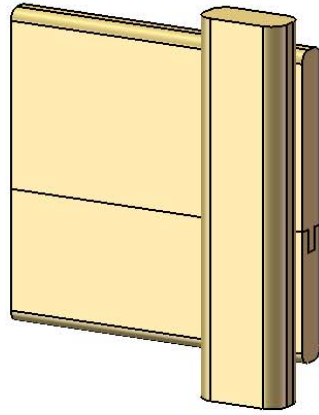

CHIMNEY
REAR
ASSEMBLY

1

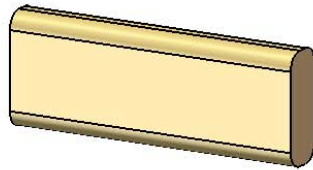

5/4X3X6-3/4"
CHIMNEY
MOUNTING
BLOCK

1

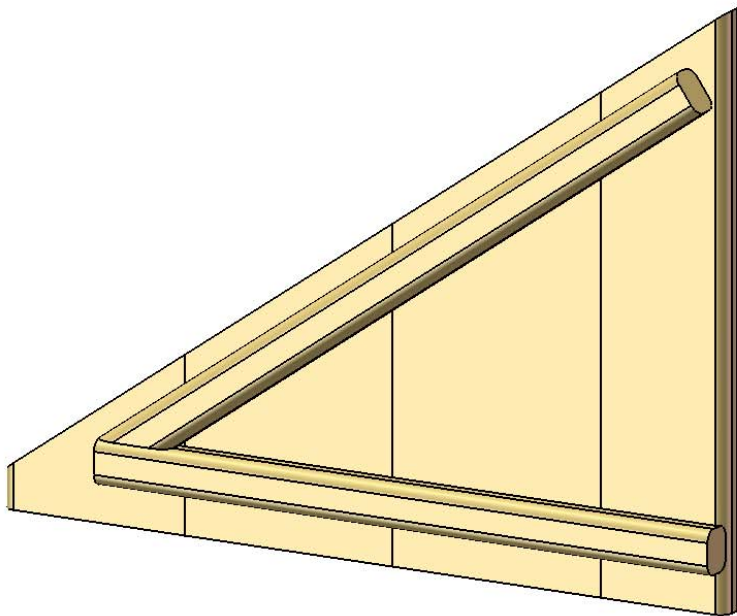

DORMER
LEFT SIDE
ASSEMBLY

2

PICTURE

DESCRIPTION

QTY.

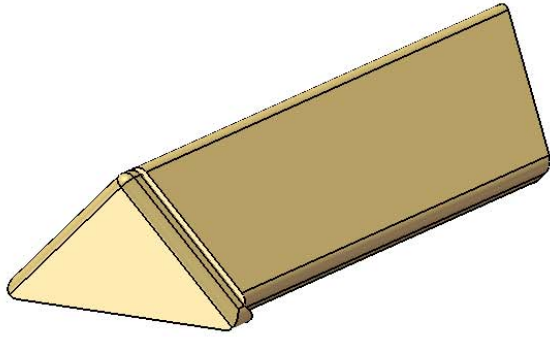

DORMER
ROOF PEAK
ASSEMBLY

2

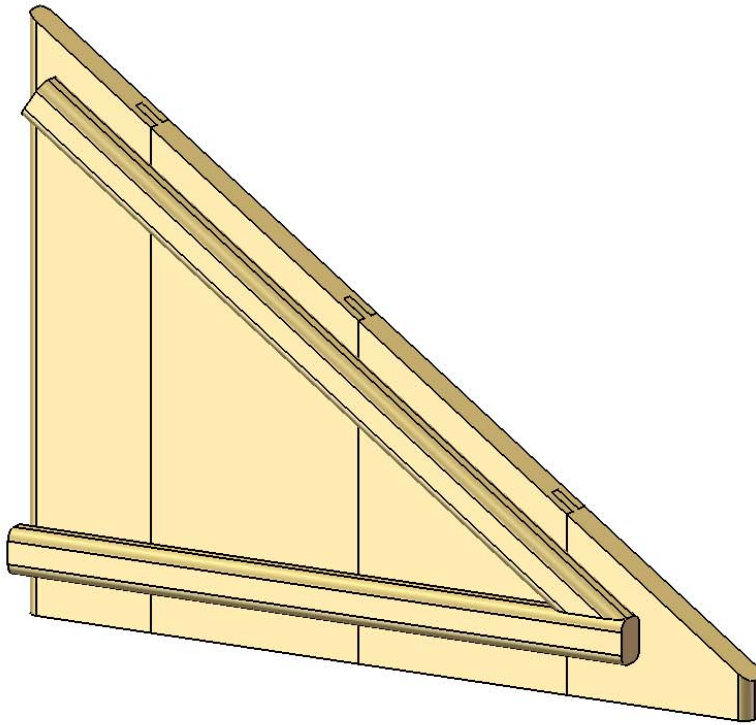

DORMER
RIGHT SIDE
ASSEMBLY

2

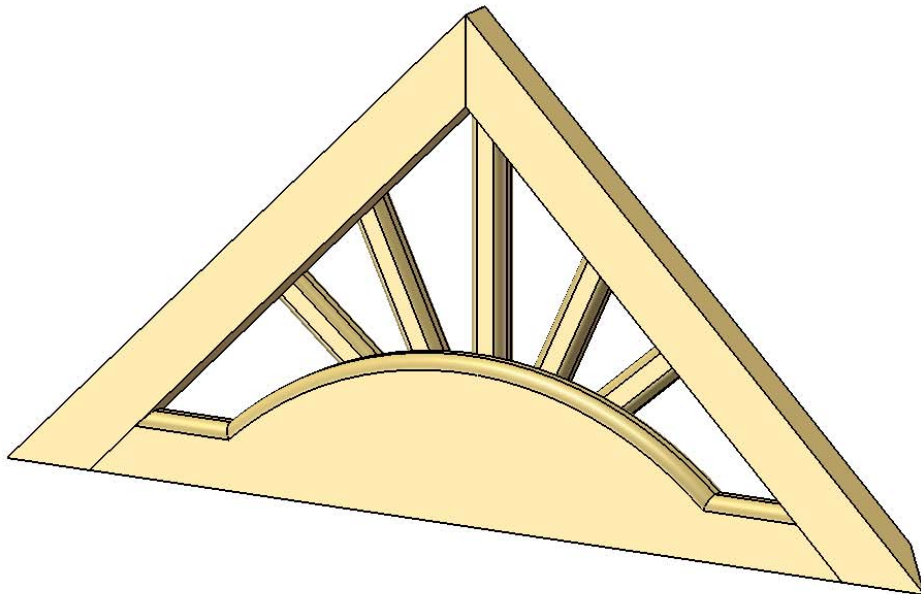

DORMER
SUNRAY
ASSEMBLY

2

STEP 1: DORMER

1: FIND TWO LEFT SIDE AND TWO RIGHT SIDE DORMER ROOF ASSEMBLIES.

2: FIND TWO DORMER SUNRAY ASSEMBLIES.

3: PLACE THE LEFT AND RIGHT ROOF ASSEMBLIES ON THE BACK SIDE OF THE DORMER SUNRAY ASSEMBLY AS SHOWN BELOW.

4: ATTACH THE DORMER ROOF SIDES TO THE DORMER SUNRAY WITH 1-1/4" WOOD SCREWS FROM THE ROOF BOARDS OF THE ROOF ASSEMBLIES.

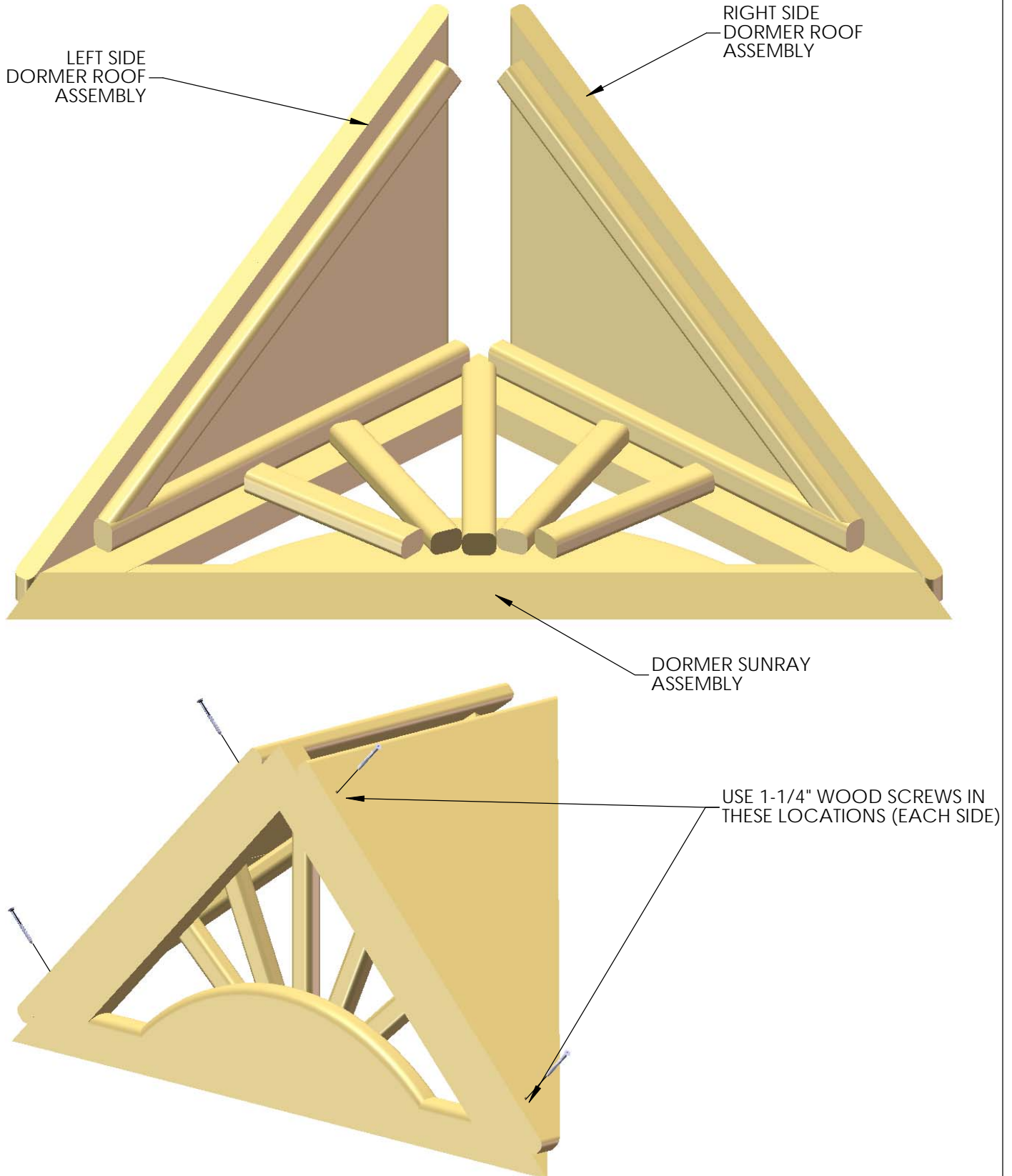

STEP 2: DORMER

1: FIND THE DORMER ROOF PEAK ASSEMBLY.

2: PLACE THE ROOF PEAK ASSEMBLY IN THE TOP OF THE ROOF AND FASTEN WITH 1-1/4" WOOD SCREWS.

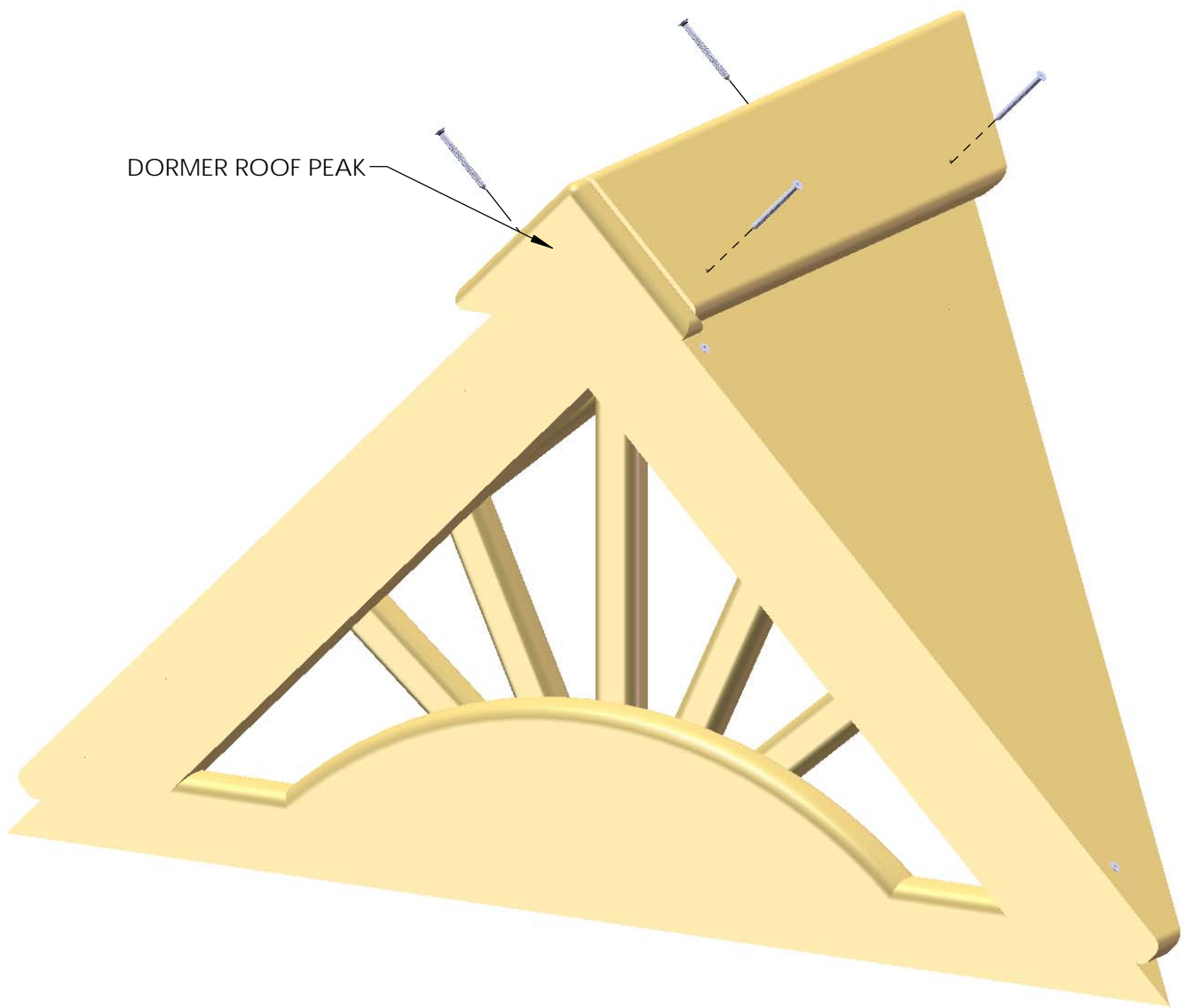

STEP 3: DORMER

- 1: CENTER THE DORMER ASSEMBLIES ON THE ROOF.
- 2: USE A 2" WOOD SCREW TO FASTEN THE DORMER PEAK TO THE ROOF.
- 3: USE 1-1/2" WOOD SCREWS TO FASTEN THE FACE OF THE DORMER TO THE ROOF.

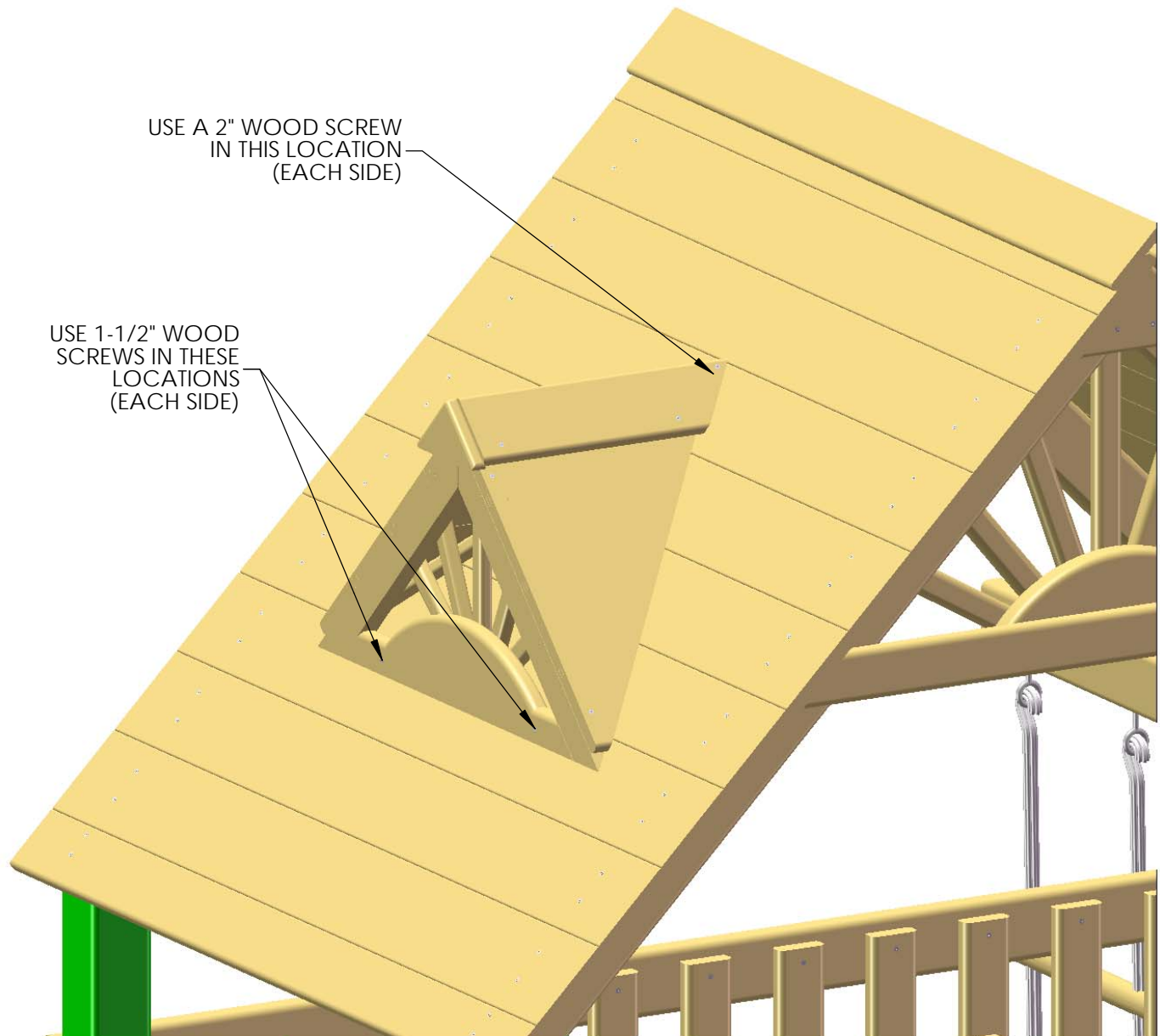

THE UNIT SHOWN ABOVE MAY NOT BE YOUR EXACT PLAYSET.
SHOWN FOR ILLUSTRATION PURPOSES ONLY

STEP 4: CHIMNEY

1: FIND THE FRONT AND LEFT SIDE OF THE CHIMNEY.

2: ATTACH THE FRONT AND LEFT SIDES OF THE CHIMNEY WITH A 2" WOOD SCREW.

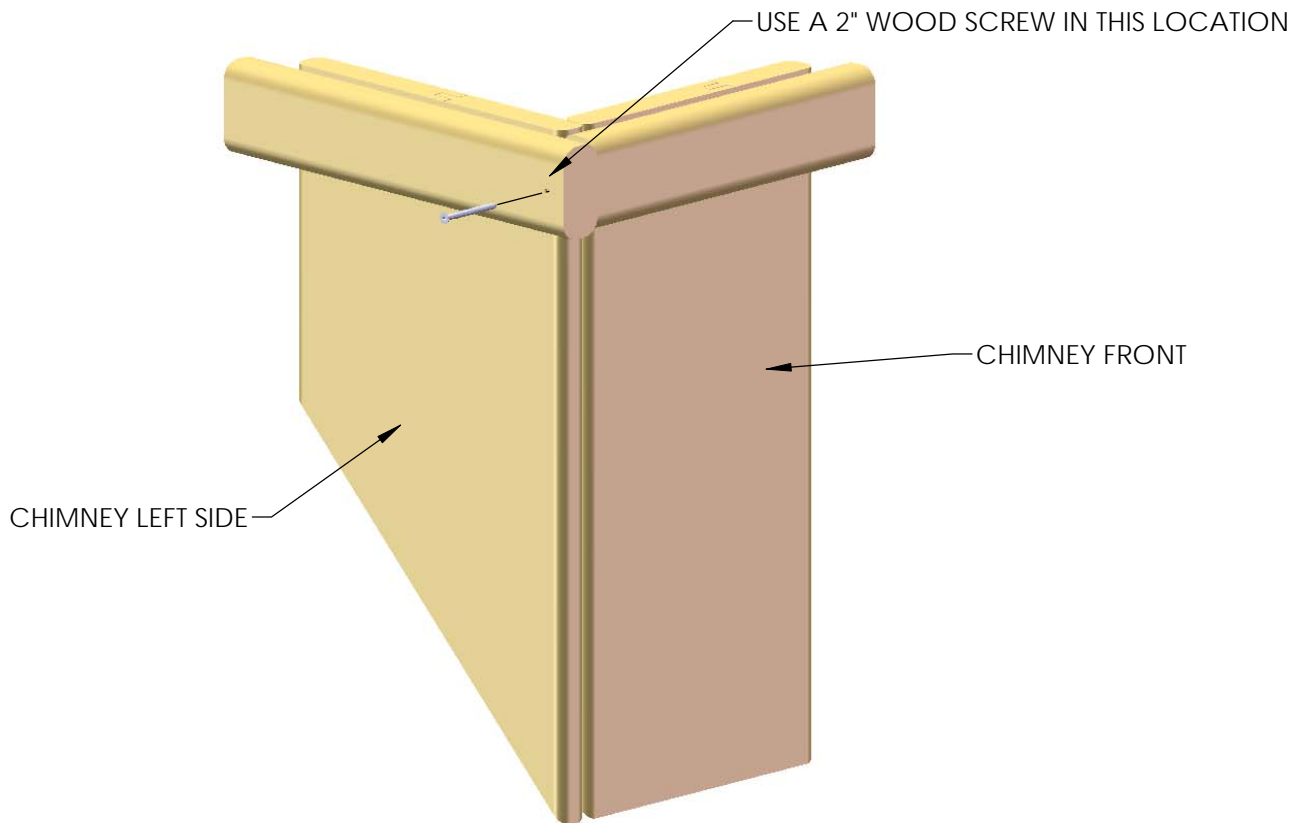

1: FIND THE REAR AND RIGHT SIDE OF THE CHIMNEY.

2: ATTACH THE REAR AND RIGHT SIDES OF THE CHIMNEY WITH A 2" WOOD SCREW.

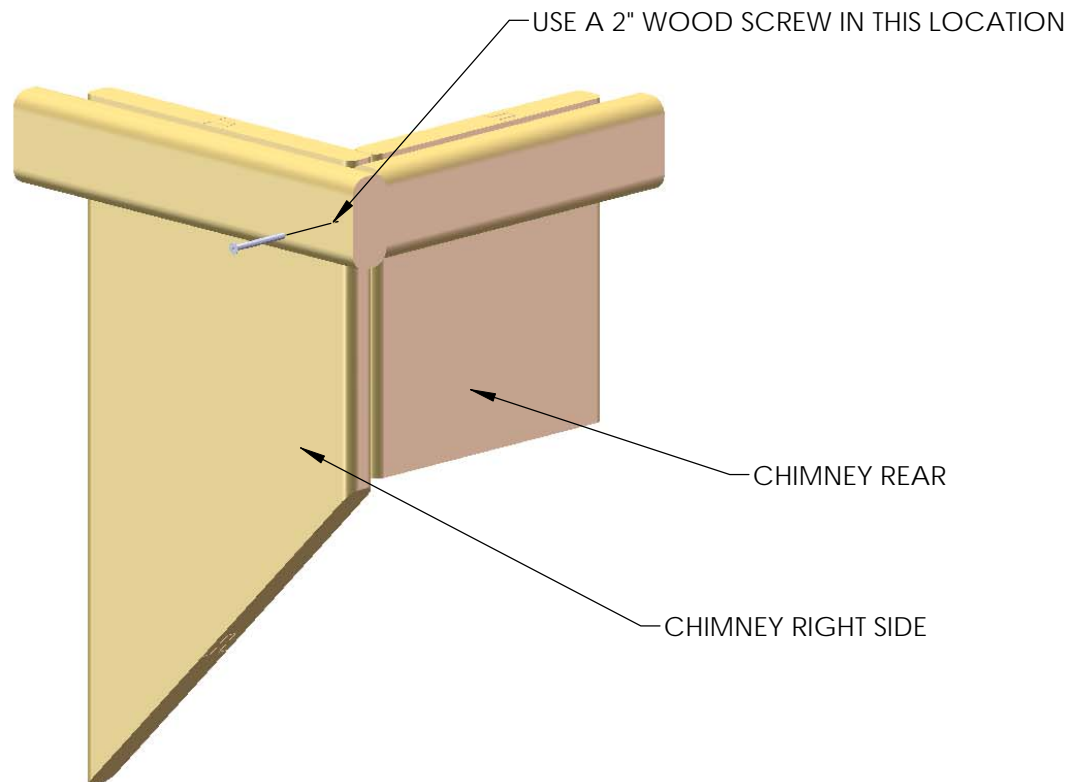

STEP 5: CHIMNEY

1: ATTACH THE CHIMNEY SIDES FROM THE PREVIOUS SIDES TO FORM THE CHIMNEY WITH 2" AND 1-1/4" WOOD SCREWS.

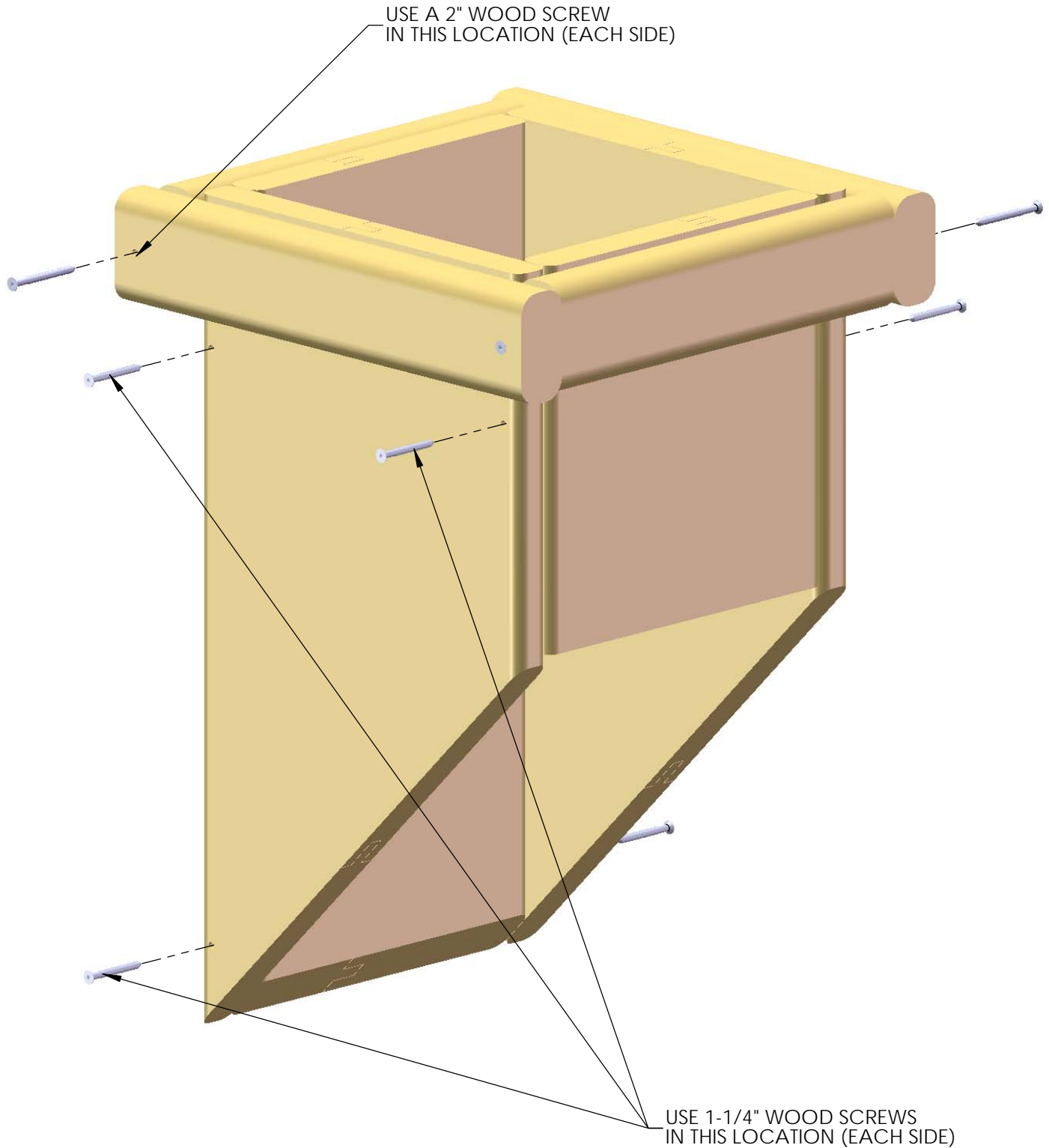

STEP 6: CHIMNEY

1: FASTEN THE 5/4 X 3 X 6-3/4" CHIMNEY MOUNTING BLOCK TO THE ROOF WITH 1-1/2" WOOD SCREWS. YOU CAN PLACE THE BLOCK AT ANY DESIRED PLACE ON THE ROOF. USE THE DIAGRAM BELOW AS A GUIDE AS TO WHERE YOU MIGHT INSTALL YOUR CHIMNEY.

2: AFTER INSTALLING THE CHIMNEY MOUNTING BLOCK, PLACE THE CHIMNEY ASSEMBLY ON THE ROOF SO THAT THE INSIDE OF THE BACK WALL RESTS AGAINST THE BLOCK.

3: FASTEN THE CHIMNEY TO THE CHIMNEY MOUNTING BLOCK WITH A 1-1/2" WOOD SCREW IN EACH SIDE.

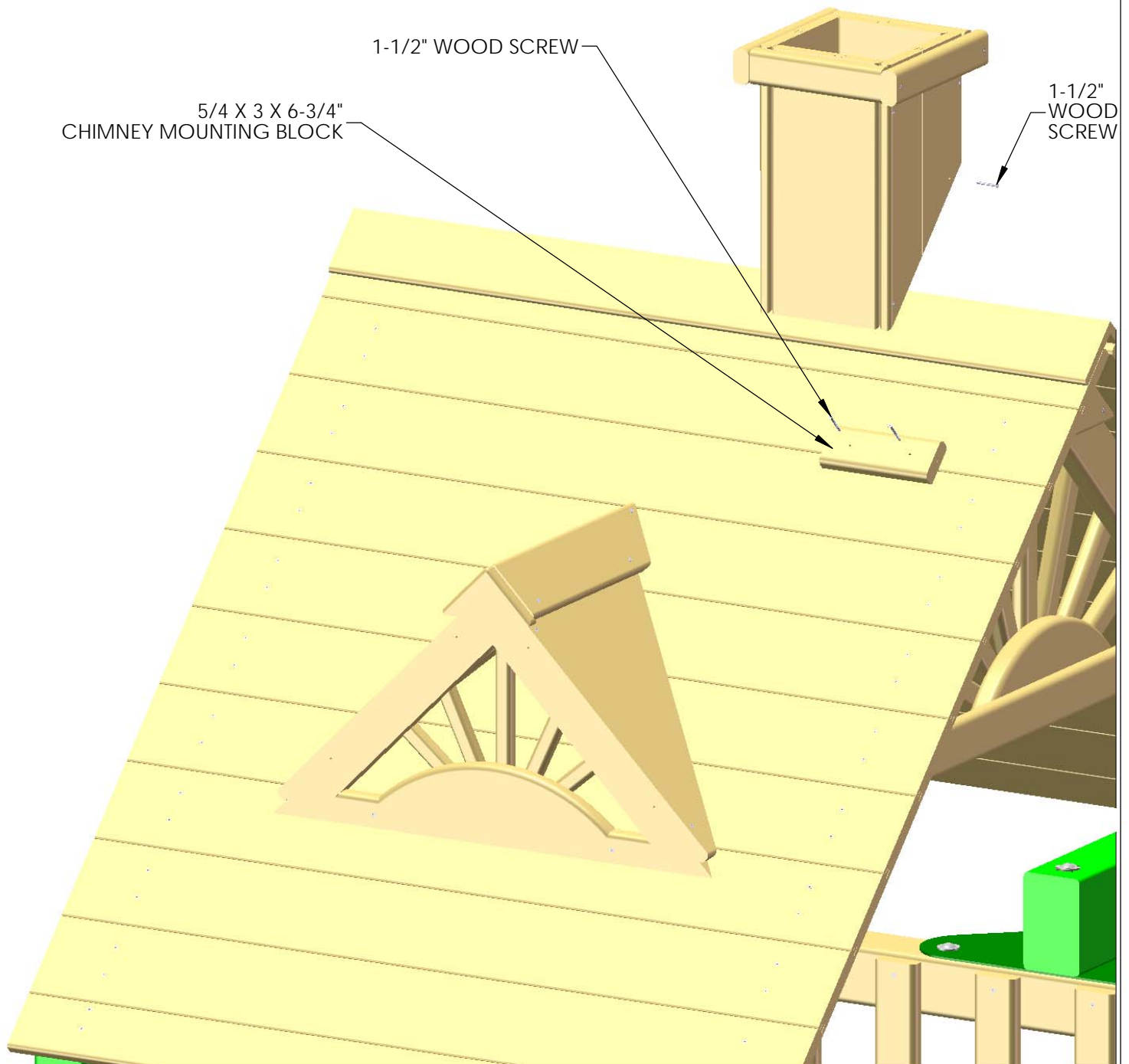

ABOVE UNIT MAY NOT BE YOUR EXACT PLAYSET.
SHOWN FOR ILLUSTRATION PURPOSES ONLY.